



US00D741113S

(12) **United States Design Patent**
Miros et al.

(10) **Patent No.:** **US D741,113 S**
(45) **Date of Patent:** **** Oct. 20, 2015**

(54) **BOTTLE**

(56) **References Cited**

(71) Applicant: **PlanetBox, LLC**, San Rafael, CA (US)

U.S. PATENT DOCUMENTS

(72) Inventors: **Robert H. J. Miros**, Fairfax, CA (US);
Brittany V. Ballard, Novato, CA (US);
Jeffrey William Servaites, San Francisco, CA (US); **Maximiliano Goldschwartz**, Sunnyvale, CA (US)

4,932,225	A *	6/1990	Bighouse	62/457.4
D371,304	S *	7/1996	Onneweer	D7/511
6,119,888	A *	9/2000	Goto et al.	220/592.27
8,550,269	B2 *	10/2013	Lane	220/215
D695,069	S *	12/2013	Lane	D7/510
2013/0319966	A1 *	12/2013	Lane	215/237

* cited by examiner

(73) Assignee: **PlanetBox, LLC**, San Rafael, CA (US)

Primary Examiner — Terry Wallace

(**) Term: **14 Years**

(74) *Attorney, Agent, or Firm* — Levine Bagade Han LLP

(21) Appl. No.: **29/491,383**

(57) **CLAIM**

The ornamental design for a bottle, as shown and described.

(22) Filed: **May 20, 2014**

DESCRIPTION

(51) **LOC (10) Cl.** **07-01**

(52) **U.S. Cl.**
USPC **D7/608**

(58) **Field of Classification Search**
USPC D7/608, 510, 511; 215/12.1, 12.2, 13.1,
215/6; 220/592.16, 592.17, 592.2, 62.12;
D9/516, 549, 559
CPC A47J 41/00; A47J 41/02
See application file for complete search history.

FIG. 1 is a top perspective view of a bottle in a closed configuration;
FIG. 2 is a front view thereof;
FIG. 3 is a rear view thereof;
FIG. 4 is a left side view thereof;
FIG. 5 is a right side view thereof;
FIG. 6 is a top view thereof;
FIG. 7 is a bottom view thereof; and,
FIG. 8 is a top perspective view of the bottle in an open configuration.
All features illustrated in phantom line are expressly disclaimed and form no part of the claimed design.

1 Claim, 8 Drawing Sheets

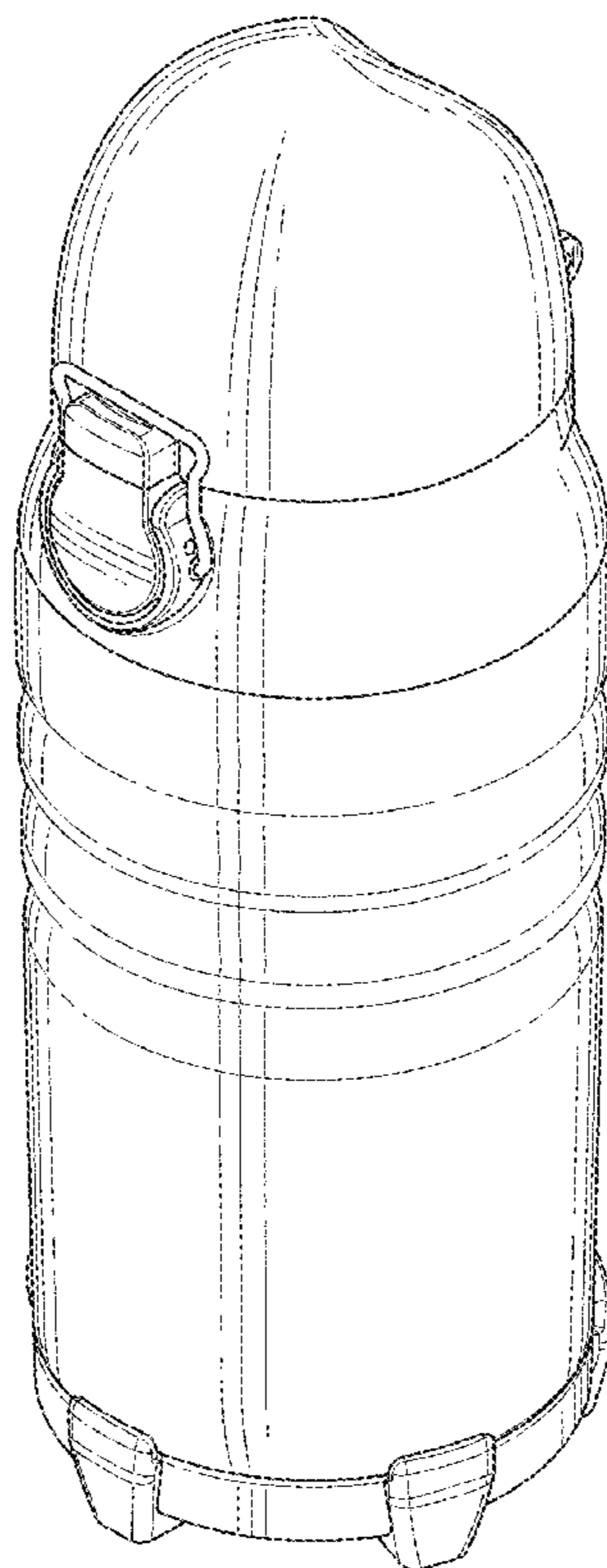

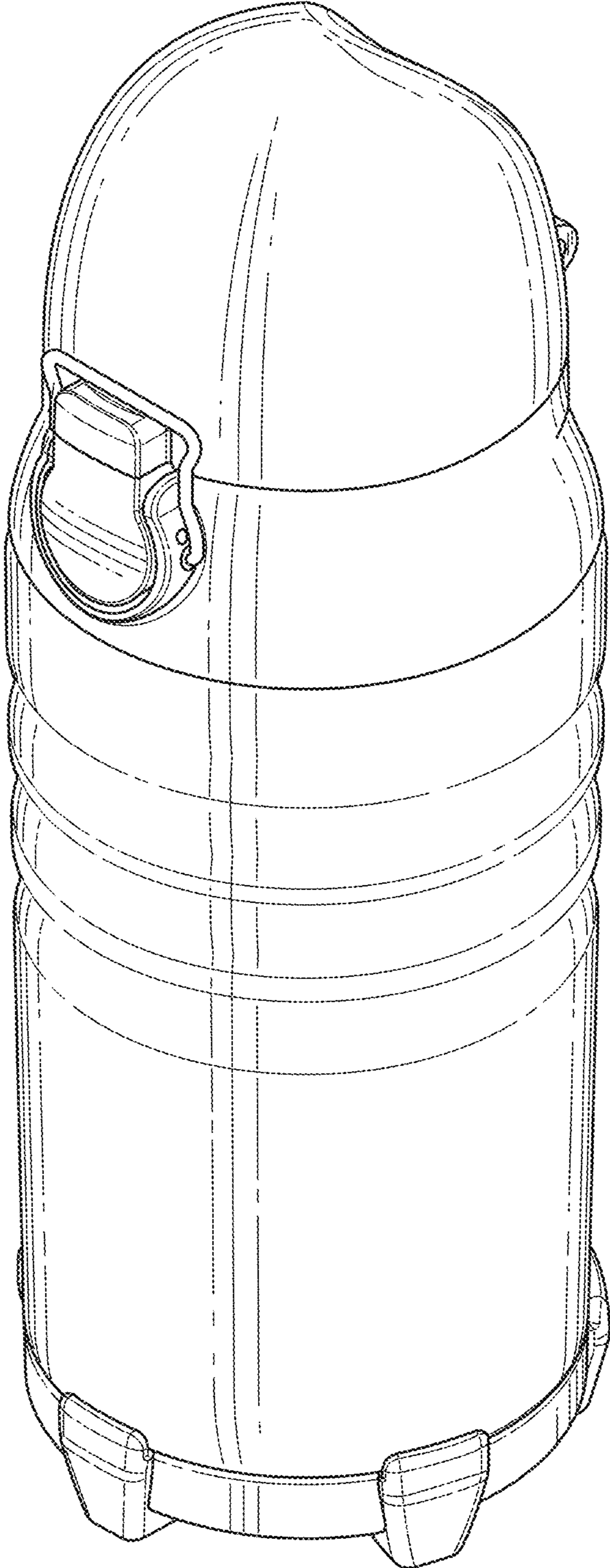

FIG. 1

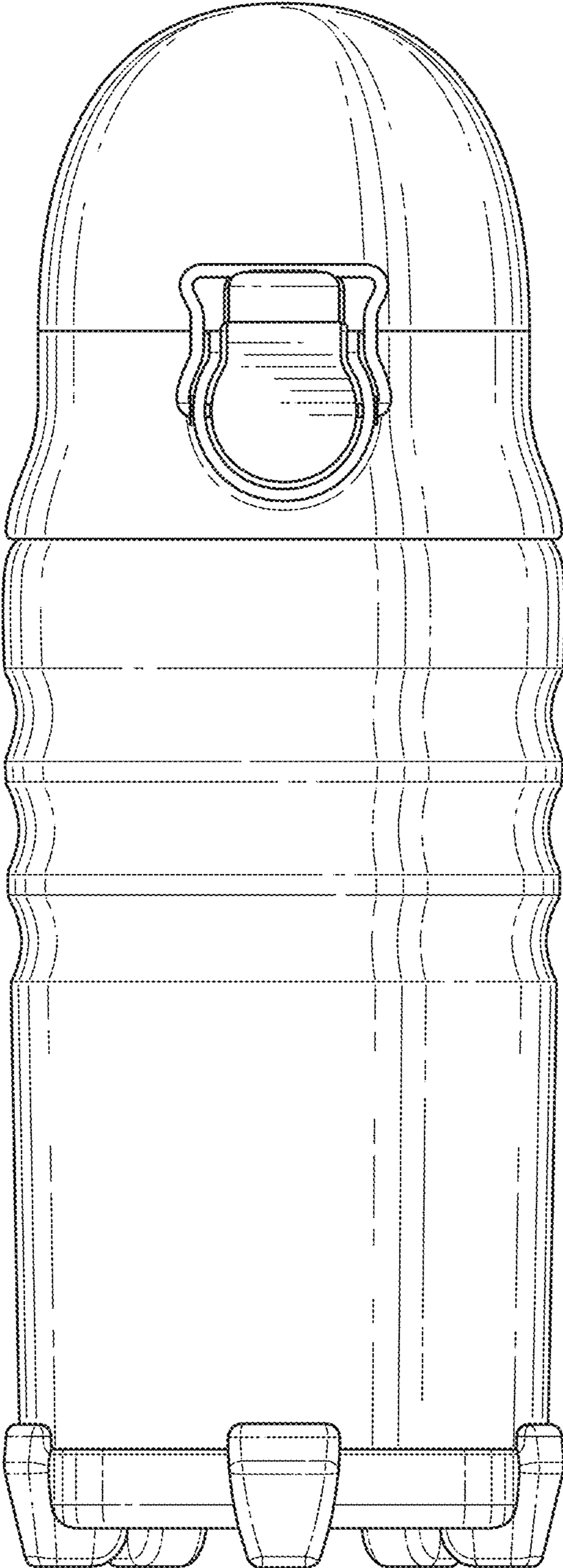

FIG. 2

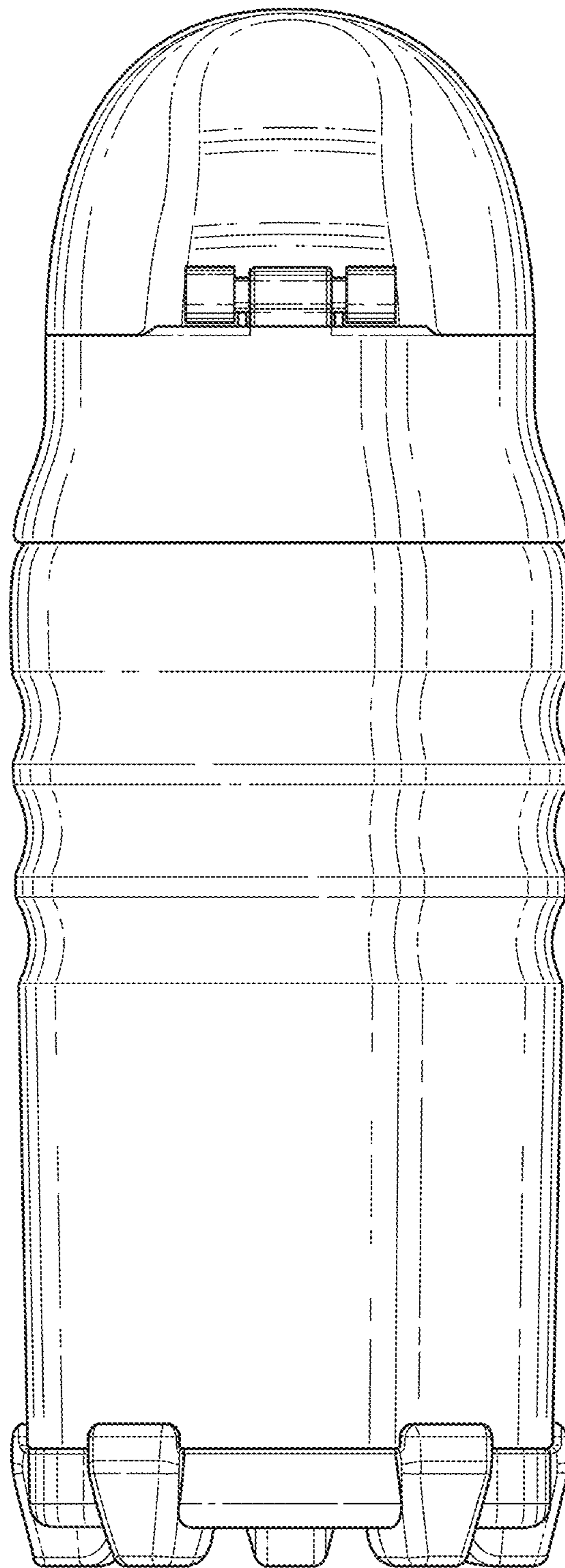

FIG. 3

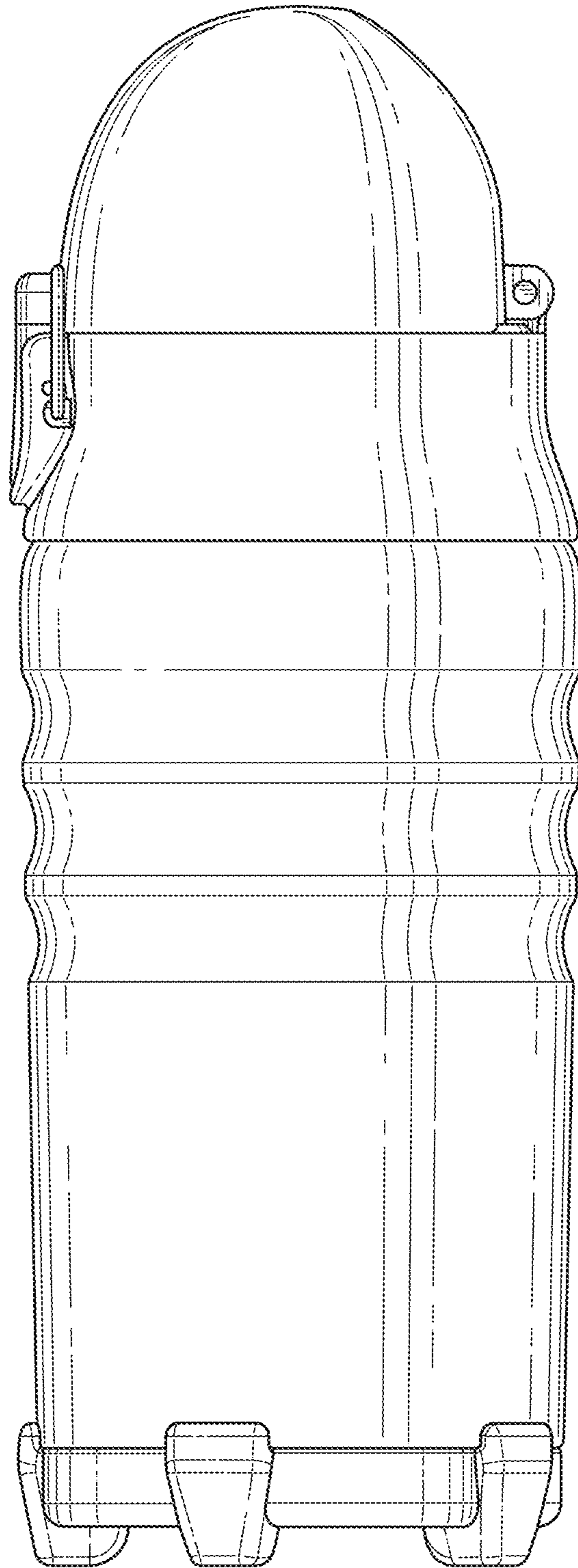

FIG. 4

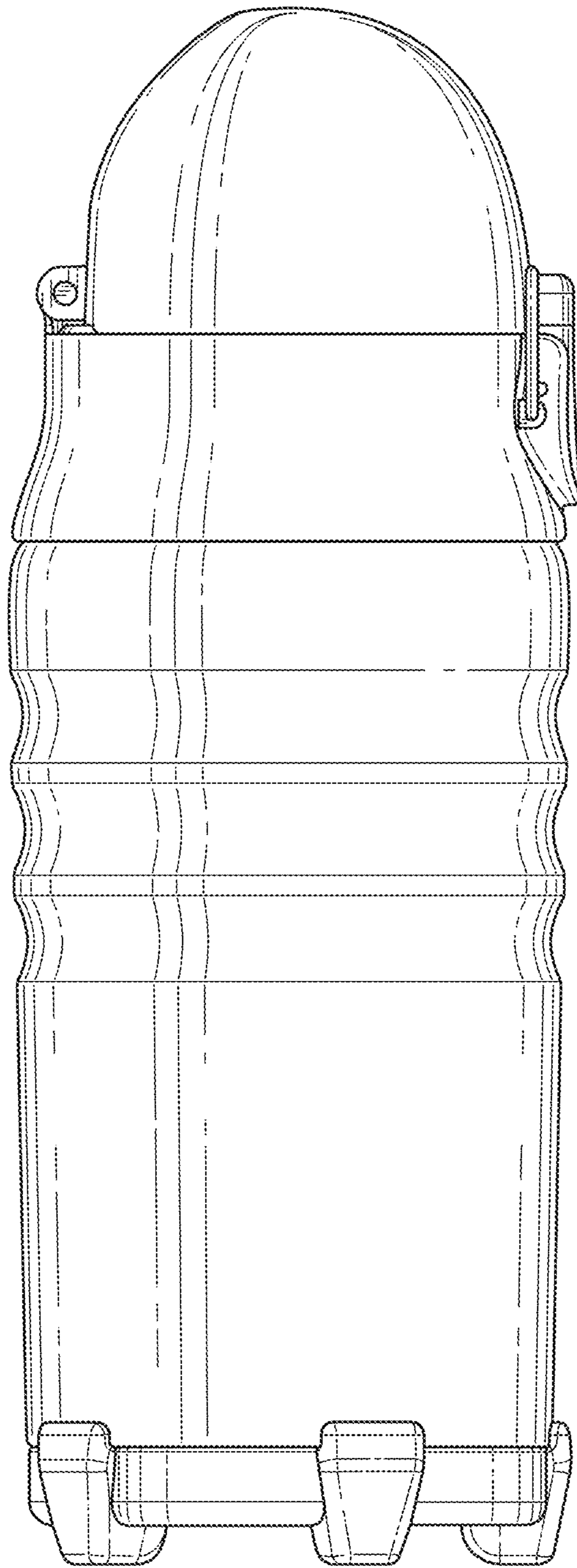

FIG. 5

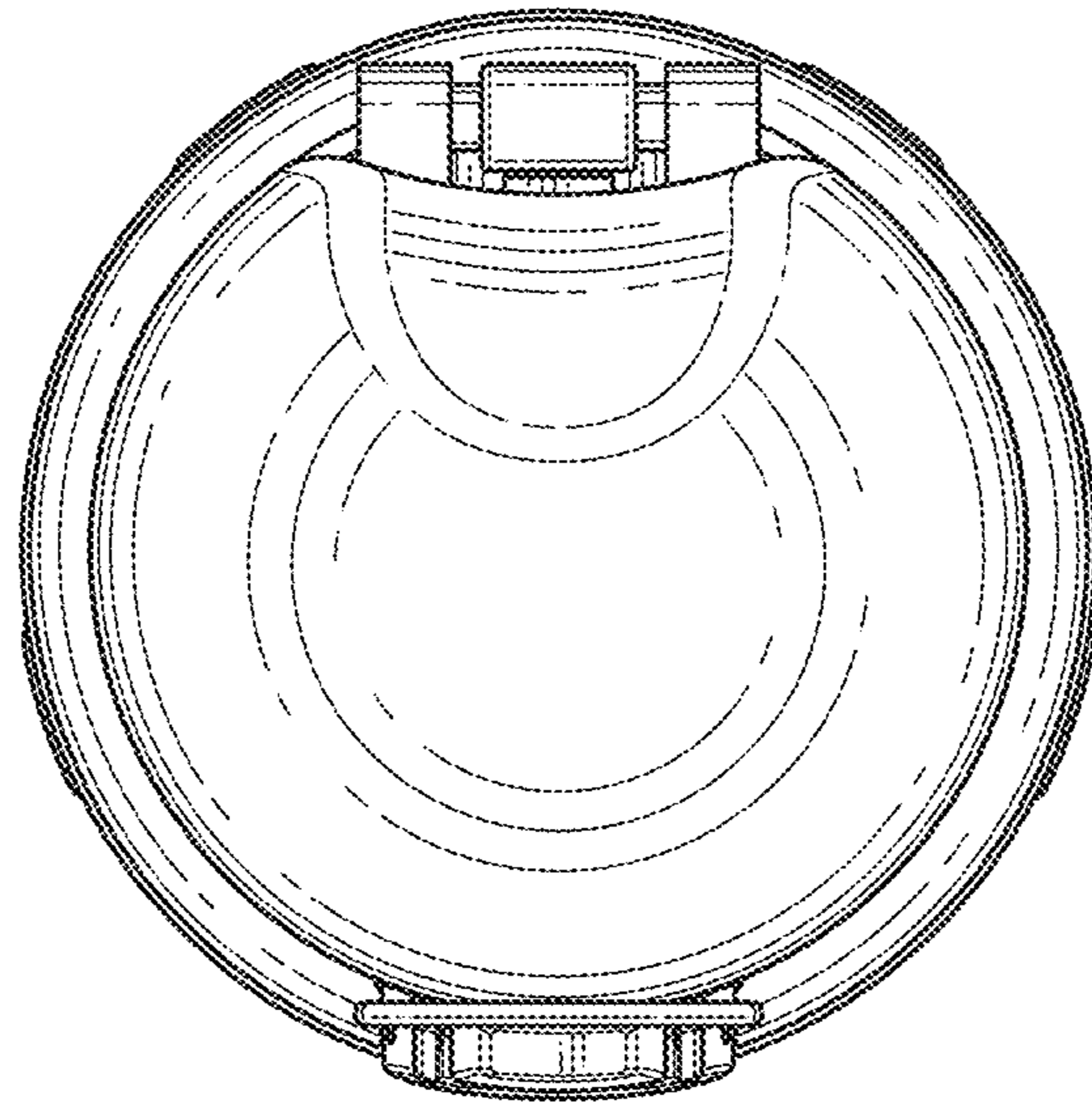

FIG. 6

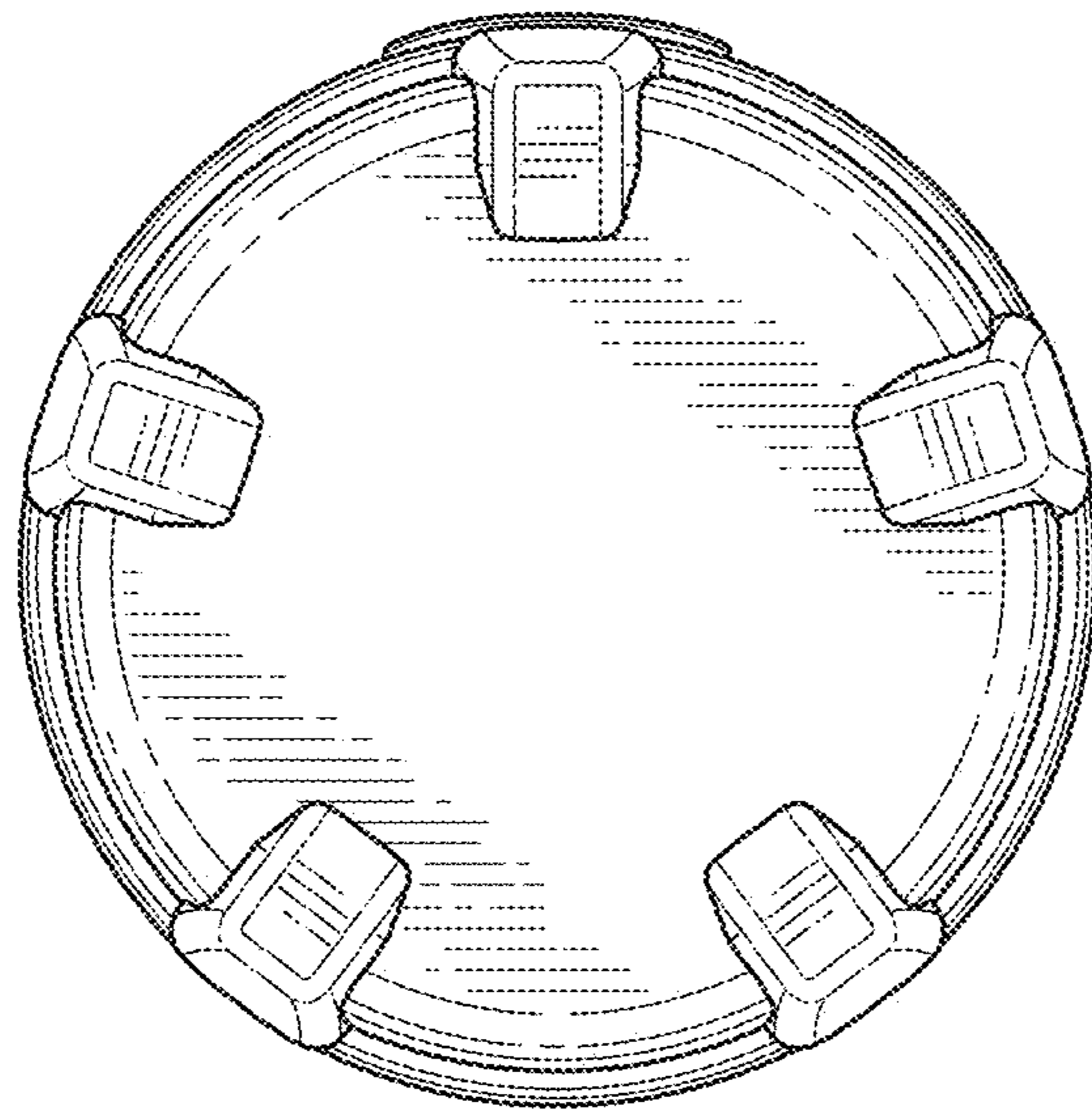

FIG. 7

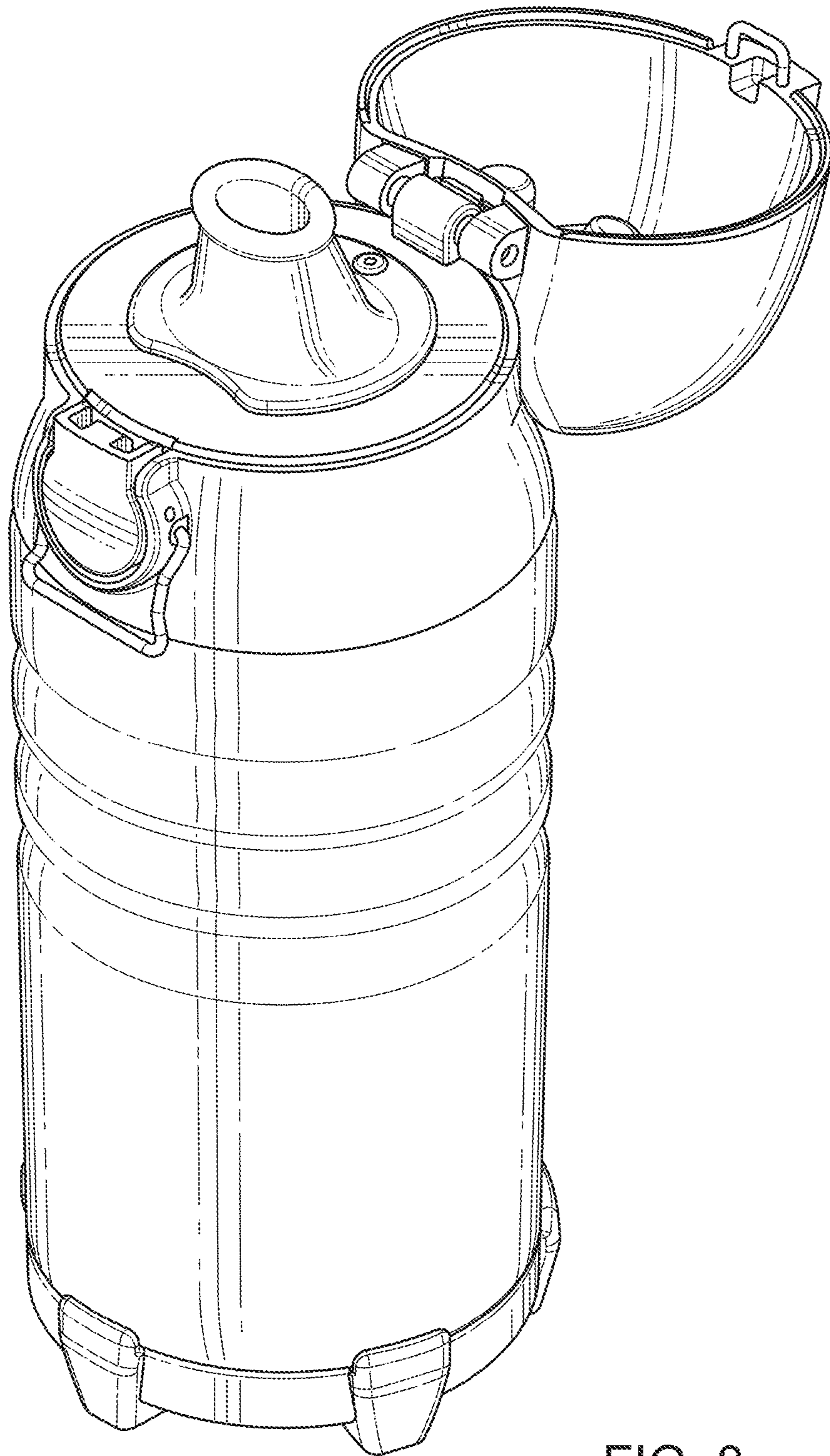

FIG. 8