



US00D741096S

(12) **United States Design Patent**
Leduc et al.

(10) **Patent No.:** **US D741,096 S**
(45) **Date of Patent:** **** Oct. 20, 2015**

- (54) **CABINET WITH EXTENSION**
- (71) Applicants: **Stéphane Leduc**, Charlotte, NC (US);
Holger Kappler, Pfalzgrafenweiler (DE)
- (72) Inventors: **Stéphane Leduc**, Charlotte, NC (US);
Holger Kappler, Pfalzgrafenweiler (DE)
- (73) Assignees: **Sirona Dental, Inc.**, Long Island City,
NY (US); **Kappler Med+Org GmbH**,
Pfalzgrafenweiler (DE)
- (**) Term: **14 Years**

- (21) Appl. No.: **29/482,827**
- (22) Filed: **Feb. 21, 2014**
- (51) **LOC (10) Cl.** **06-04**
- (52) **U.S. Cl.**
USPC **D6/705**
- (58) **Field of Classification Search**
USPC D3/273, 296-298; D6/657, 661-664,
D6/671, 671.1, 671.2, 684, 691, 703, 705,
D6/705.2, 705.4, 705.5, 707.2; D18/59
CPC A47B 83/045; A47B 87/02; A47B 88/00;
A47B 88/10; A47B 88/20; A47B 88/0003;
A47B 88/0007; A47B 88/0014; A47B
88/0407; A47B 88/0044; A47B 88/044;
A47B 88/047; A47B 88/04; A47B 88/0055;
A47B 2088/0081; E05B 65/44; E05B 65/46;
E05B 65/462
See application file for complete search history.

(56) **References Cited**
U.S. PATENT DOCUMENTS

2,566,954	A	*	9/1951	Murray	312/203
D234,388	S	*	2/1975	Hodges	D6/671
D254,882	S	*	5/1980	Kempf	D6/657
D337,783	S	*	7/1993	Olswold et al.	D18/59
D553,879	S	*	10/2007	Juneau	D6/671
D651,020	S	*	12/2011	Ussen	D6/671.1
D651,429	S	*	1/2012	Ussen	D6/707.2
D655,946	S	*	3/2012	Sexton	D6/661
D663,136	S	*	7/2012	Thompson	D6/671

D701,404	S	*	3/2014	Thompson	D6/671
D717,081	S	*	11/2014	Dworman	D6/657
D724,356	S	*	3/2015	Weatherly	D6/661
D728,975	S	*	5/2015	Park et al.	D6/657

* cited by examiner

Primary Examiner — Ricky Pham
(74) *Attorney, Agent, or Firm* — Fitzpatrick, Cella, Harper & Scinto

(57) **CLAIM**
The ornamental design for a cabinet with extension, as shown and described.

DESCRIPTION

FIG. 1 is a right, top, and front perspective view of a first embodiment of the cabinet with extension showing a door in a closed position and an extension in a retracted position; FIG. 2 is a right side view of the cabinet with extension shown in FIG. 1, the left side view being a substantially mirror image of FIG. 2; FIG. 3 is a front view of the cabinet with extension shown in FIG. 1; FIG. 4 is a top view of the cabinet with extension shown in FIG. 1; FIG. 5 is a bottom view of the cabinet with extension shown in FIG. 1; FIG. 6 is a rear view of the cabinet with extension shown in FIG. 1; FIG. 7 is a right, top, and front perspective view of the first embodiment of the cabinet with extension showing the door in an opened position and the extension in the retracted position, the rear view of the cabinet with extension being substantially identical to the rear view shown in FIG. 6; FIG. 8 is a right side view of the cabinet with extension shown in FIG. 7, the left side view being a substantially mirror image of FIG. 8; FIG. 9 is a front view of the cabinet with extension shown in FIG. 7; FIG. 10 is a top view of the cabinet with extension shown in FIG. 7; FIG. 11 is a bottom view of the cabinet with extension shown in FIG. 7;

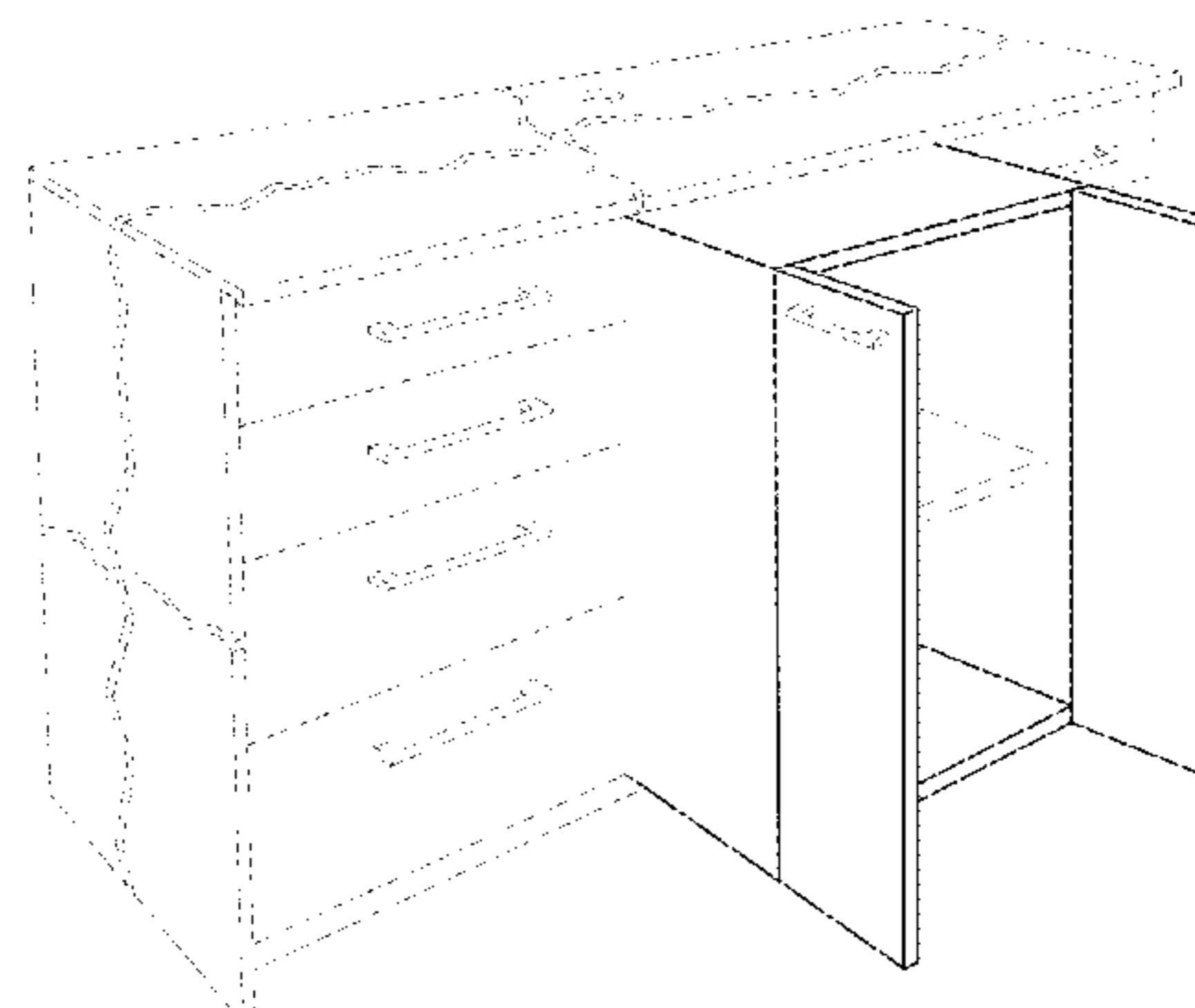
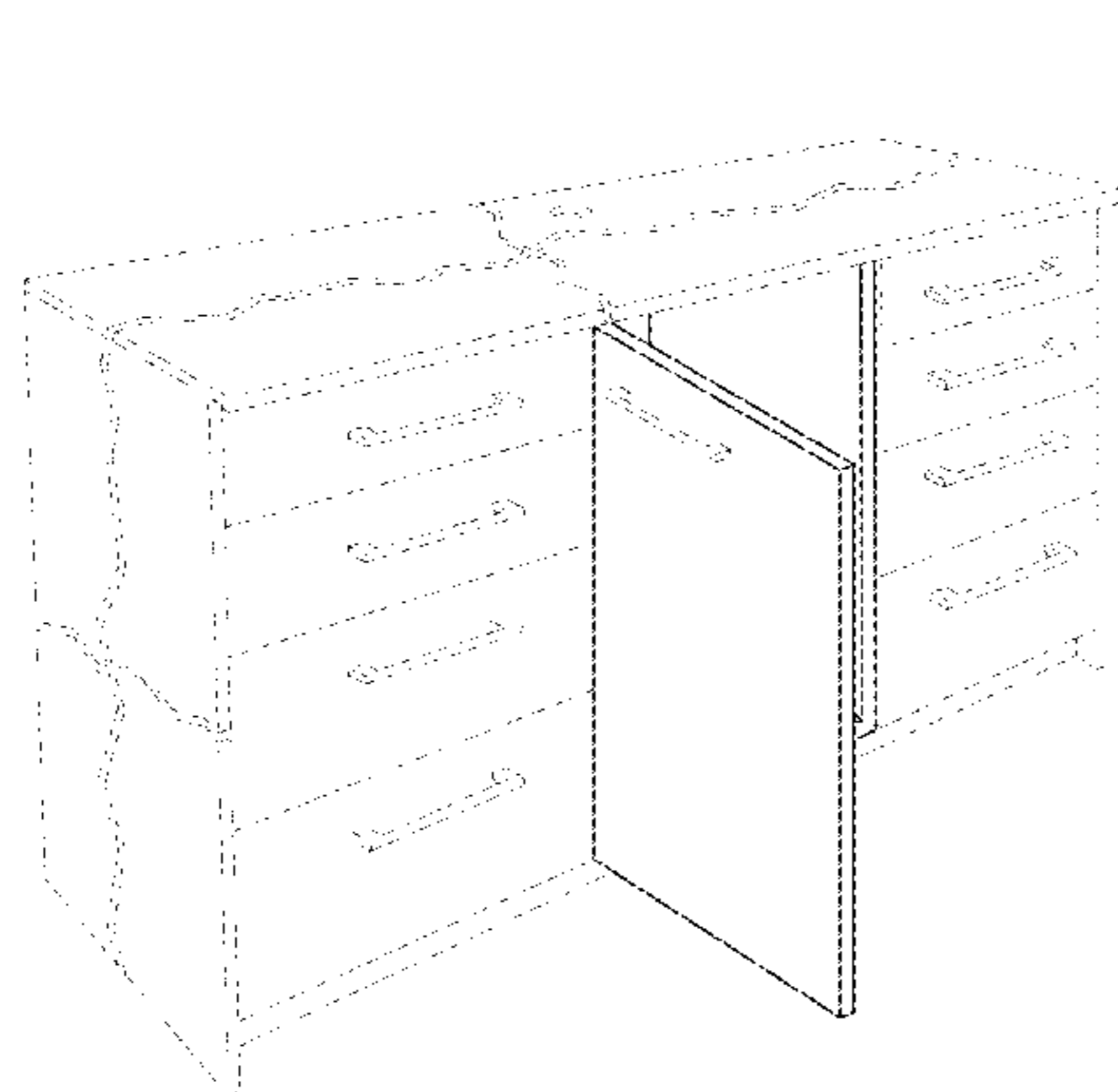

FIG. 12 is a right, top, and front perspective view of the first embodiment of the cabinet with extension showing the door in the closed position and the extension in an extended position, the rear view of the cabinet with extension being substantially identical to the rear view shown in FIG. 6;

FIG. 13 is a right side view of the cabinet with extension shown in FIG. 12, the left side view being a substantially mirror image of FIG. 13;

FIG. 14 is a front view of the cabinet with extension shown in FIG. 12;

FIG. 15 is a top view of the cabinet with extension shown in FIG. 12; FIG. 16 is a bottom view of the cabinet with extension shown in FIG. 12;

FIG. 17 is a right, top, and front perspective view of the first embodiment of the cabinet with extension showing the door in the opened position and the extension in the extended position, the rear view of the cabinet with extension being substantially identical to the rear view shown in FIG. 6;

FIG. 18 is a right side view of the cabinet with extension shown in FIG. 17, the left side view being a substantially mirror image of FIG. 18;

FIG. 19 is a front view of the cabinet with extension shown in FIG. 17;

FIG. 20 is a top view of the cabinet with extension shown in FIG. 17;

FIG. 21 is a bottom view of the cabinet with extension shown in FIG. 17;

FIG. 22 is a right, top, and front perspective view of a second embodiment of the cabinet with extension showing two doors in a closed position and an extension in a retracted position, the rear view of the cabinet with extension being substantially identical to the rear view shown in FIG. 6;

FIG. 23 is a right side view of the cabinet with extension shown in FIG. 22, the left side view being a substantially mirror image of FIG. 23;

FIG. 24 is a front view of the cabinet with extension shown in FIG. 22;

FIG. 25 is a top view of the cabinet with extension shown in FIG. 22;

FIG. 26 is a bottom view of the cabinet with extension shown in FIG. 22;

FIG. 27 is a right, top, and front perspective view of the second embodiment of the cabinet with extension showing the two doors in an opened position and the extension in the

retracted position, the rear view of the cabinet with extension being substantially identical to the rear view shown in FIG. 6; FIG. 28 is a right side view of the cabinet with extension shown in FIG. 27, the left side view being a substantially mirror image of FIG. 28;

FIG. 29 is a front view of the cabinet with extension shown in FIG. 27;

FIG. 30 is a top view of the cabinet with extension shown in FIG. 27;

FIG. 31 is a bottom view of the cabinet with extension shown in FIG. 27;

FIG. 32 is a right, top, and front perspective view of the second embodiment of the cabinet with extension showing the two doors in the closed position and the extension in an extended position, the rear view of the cabinet with extension being substantially identical to the rear view shown in FIG. 6;

FIG. 33 is a right side view of the cabinet with extension shown in FIG. 32, the left side view being a substantially mirror image of FIG. 33;

FIG. 34 is a front view of the cabinet with extension shown in FIG. 32;

FIG. 35 is a top view of the cabinet with extension shown in FIG. 32;

FIG. 36 is a bottom view of the cabinet with extension shown in FIG. 32;

FIG. 37 is a right, top, and front perspective view of the second embodiment of the cabinet with extension showing the two doors in the opened position and the extension in the extended position, the rear view of the cabinet with extension being substantially identical to the rear view shown in FIG. 6;

FIG. 38 is a right side view of the cabinet with extension shown in FIG. 37, the left side view being a substantially mirror image of FIG. 38;

FIG. 39 is a front view of the cabinet with extension shown in FIG. 37;

FIG. 40 is a top view of the cabinet with extension shown in FIG. 37; and,

FIG. 41 is a bottom view of the cabinet with extension shown in FIG. 37.

The broken, dashed lines shown in the drawings are for illustrative purposes only and form no part of the claimed design. Pairs of closely spaced, jagged dot-dash lines indicate indeterminate length and form no part of the claimed design.

1 Claim, 41 Drawing Sheets

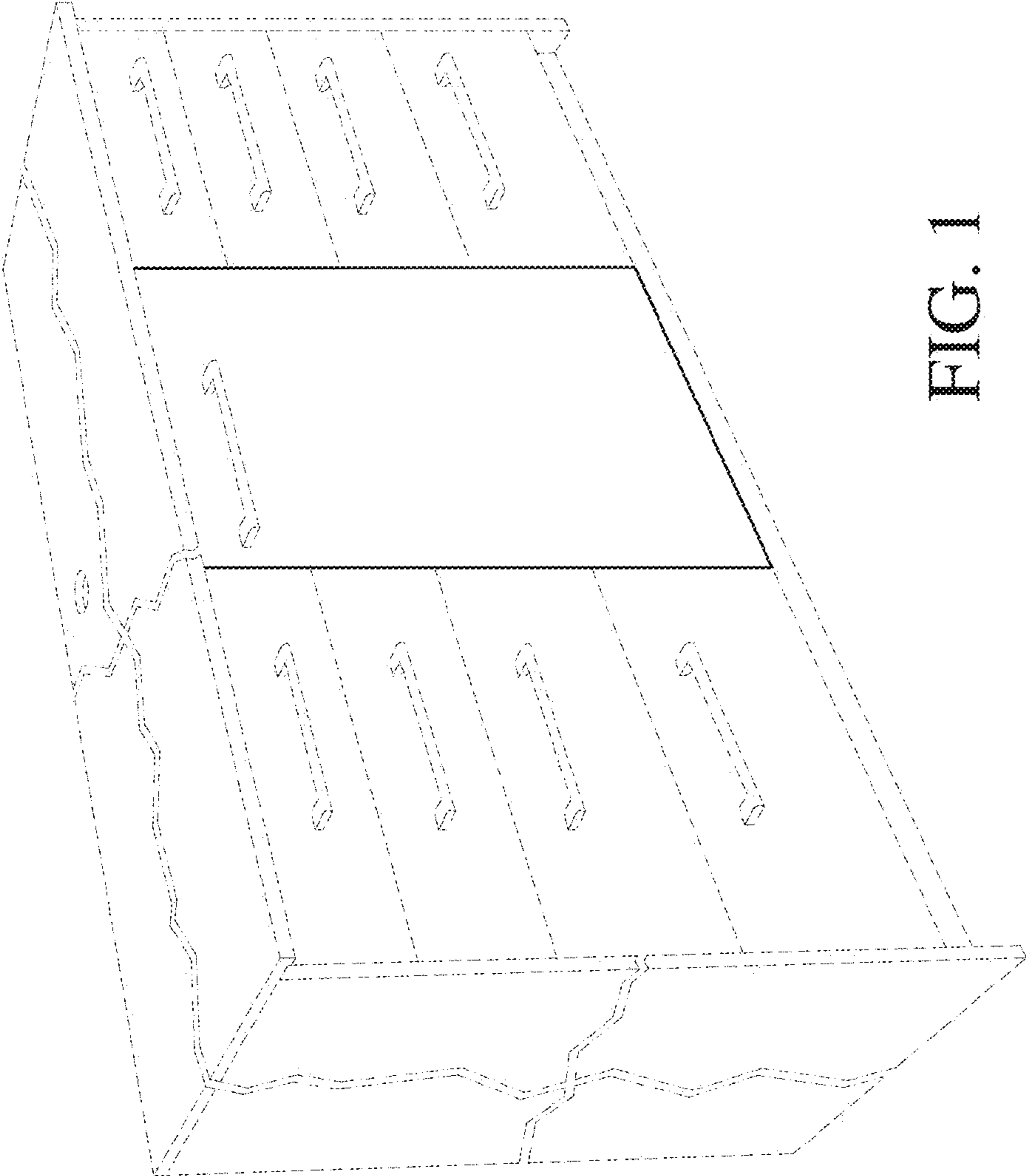

FIG. 1

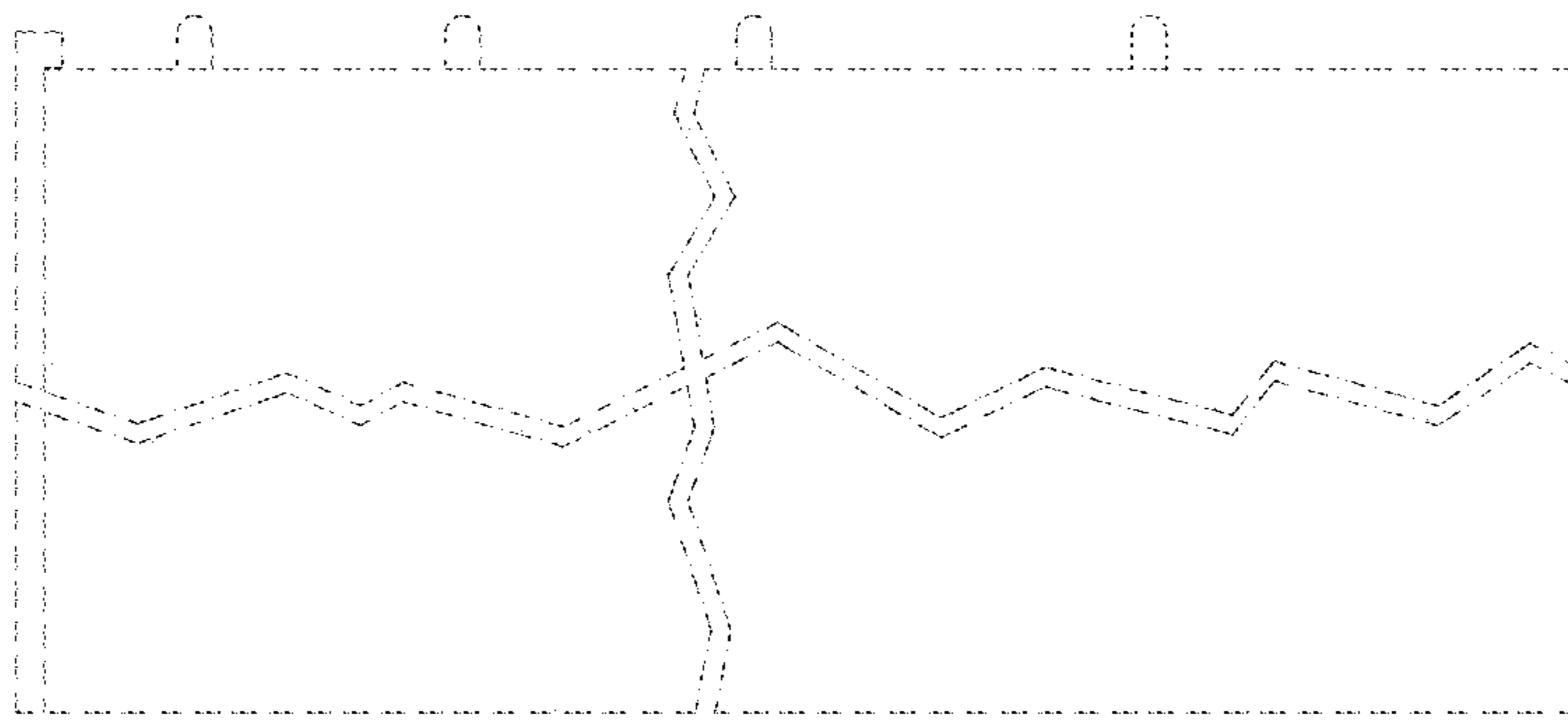

FIG. 2

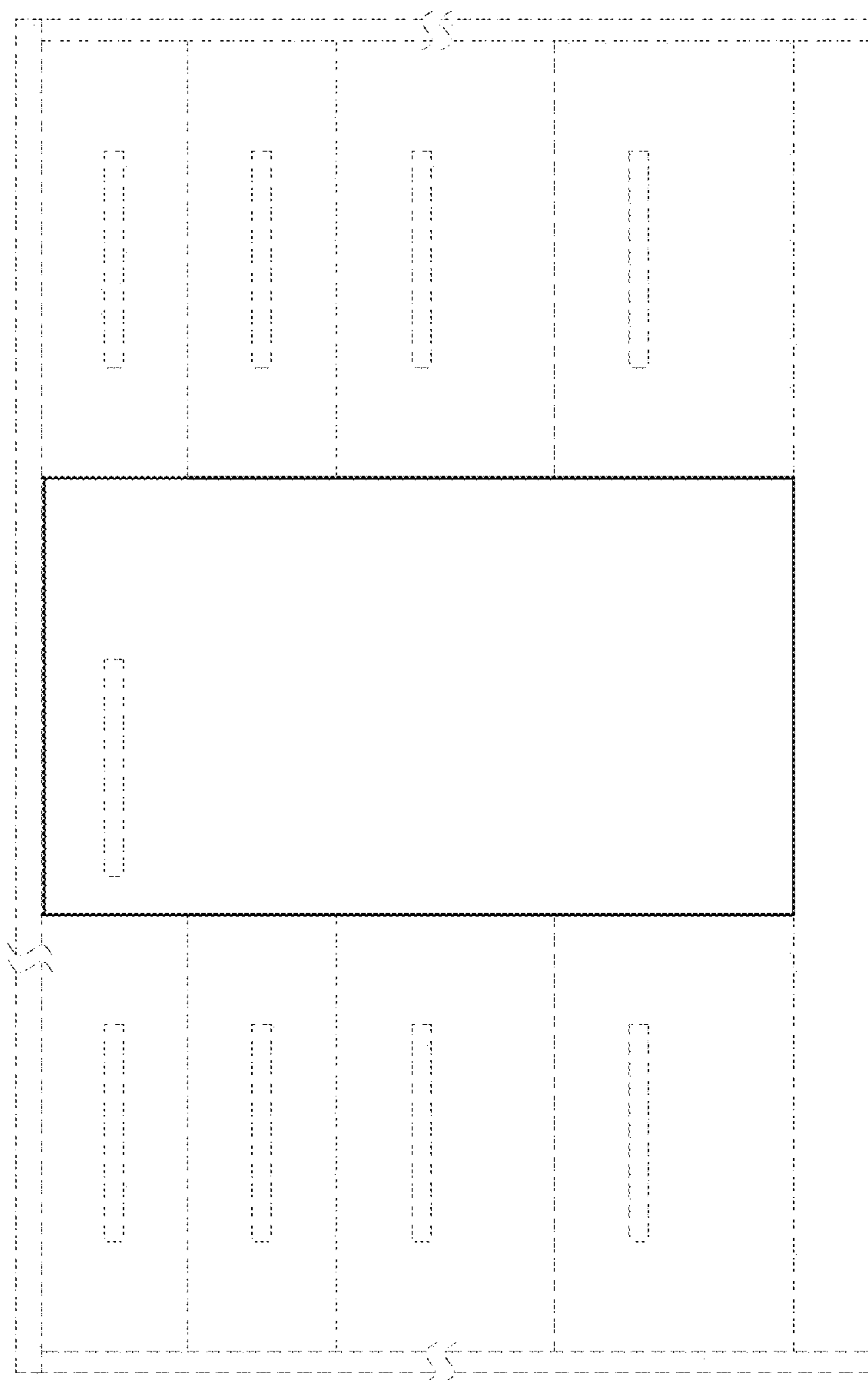

FIG. 3

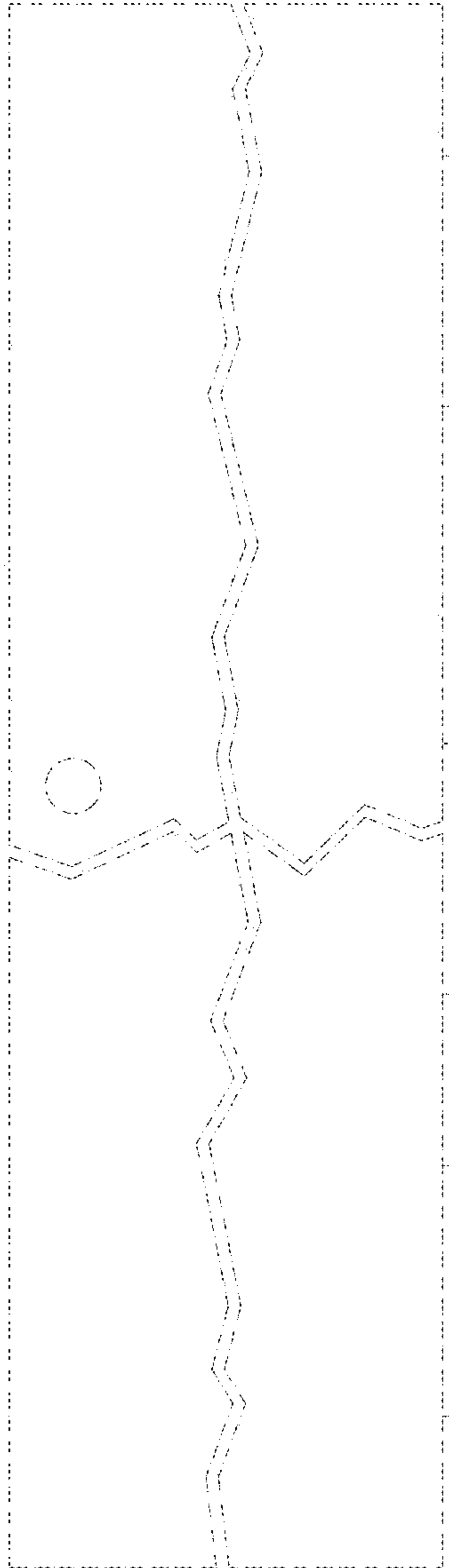

FIG. 4

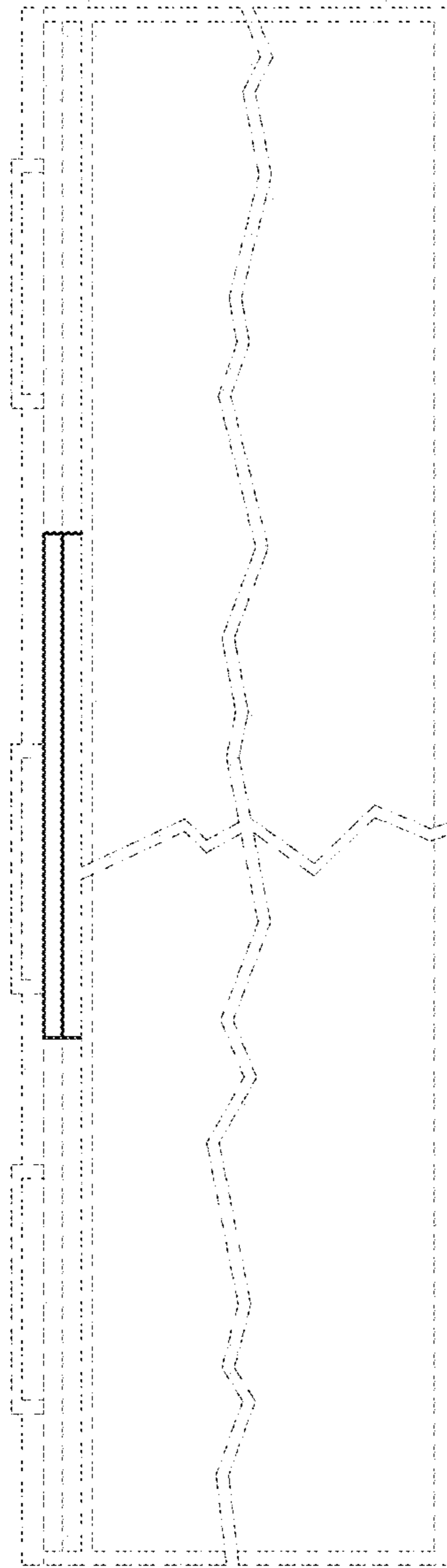

FIG. 5

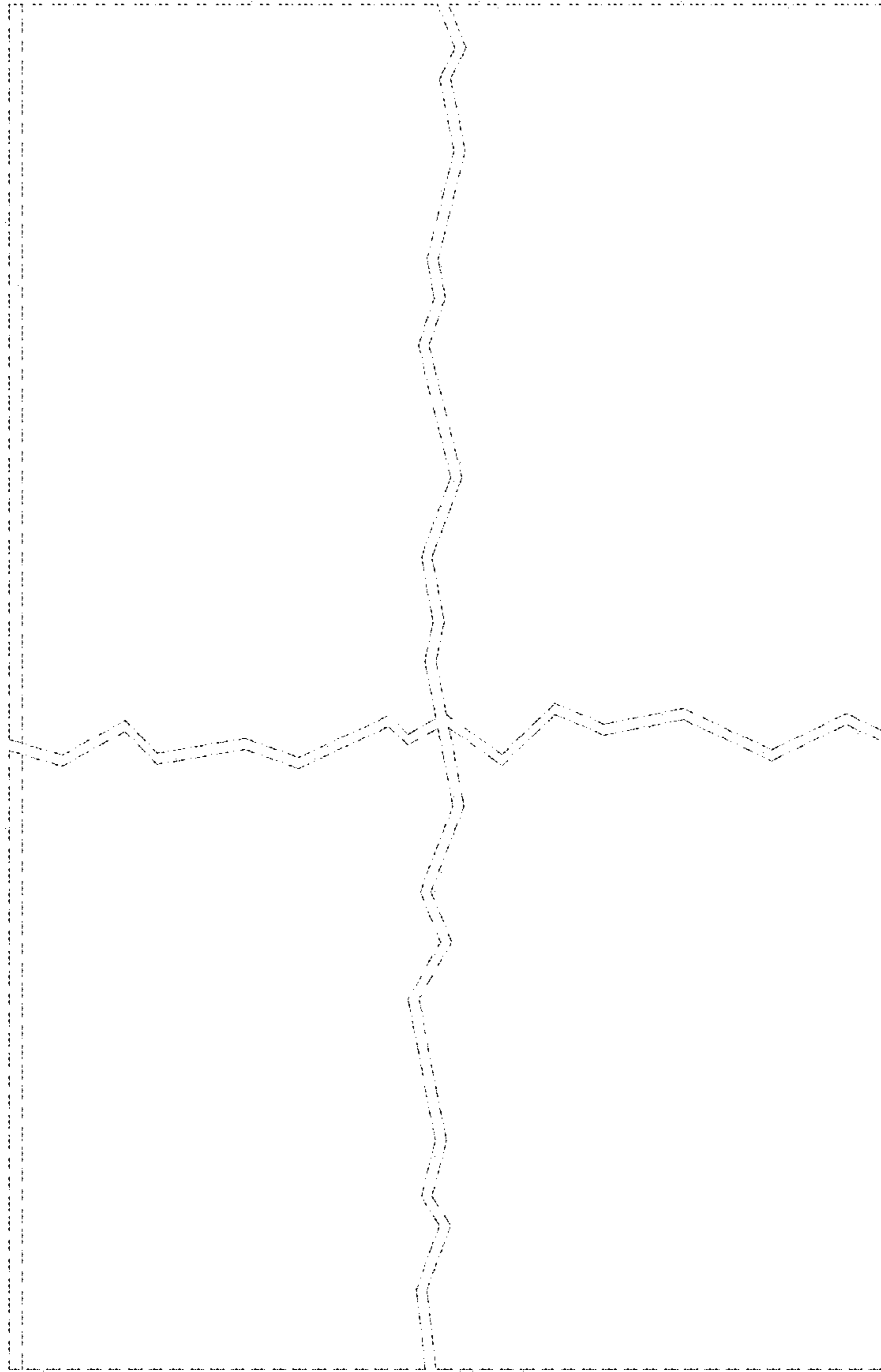

FIG. 6

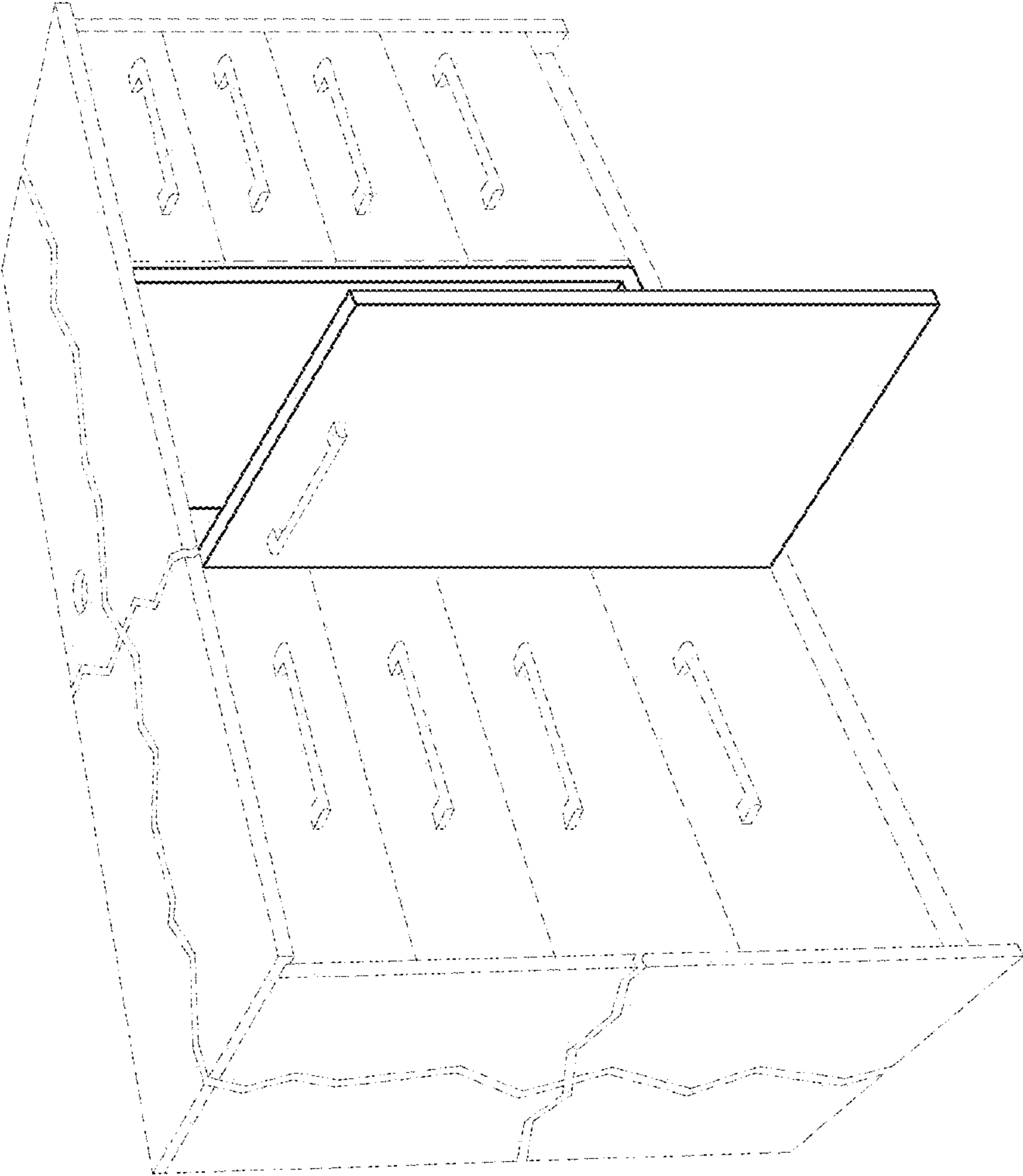

FIG. 7

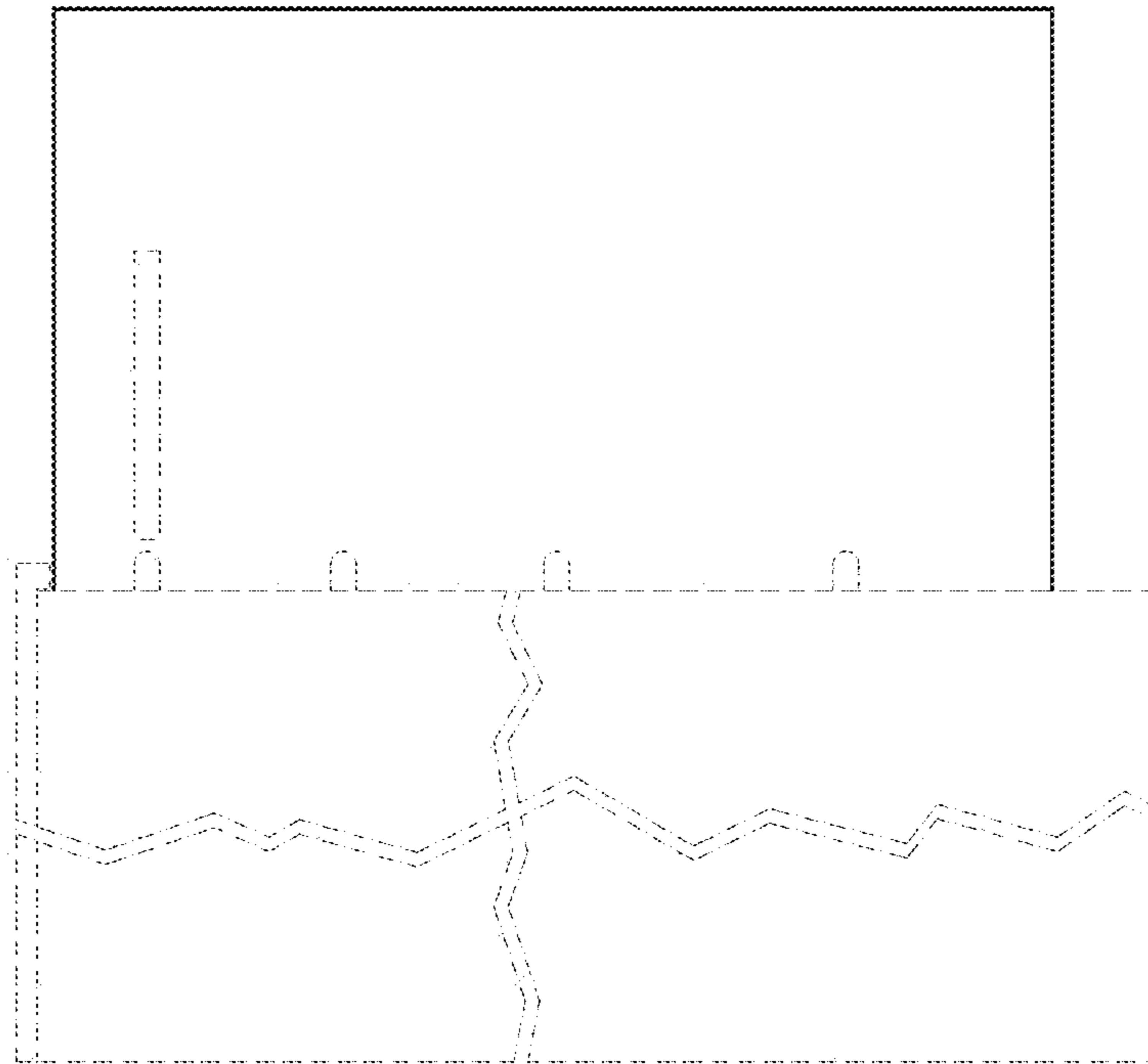

FIG. 8

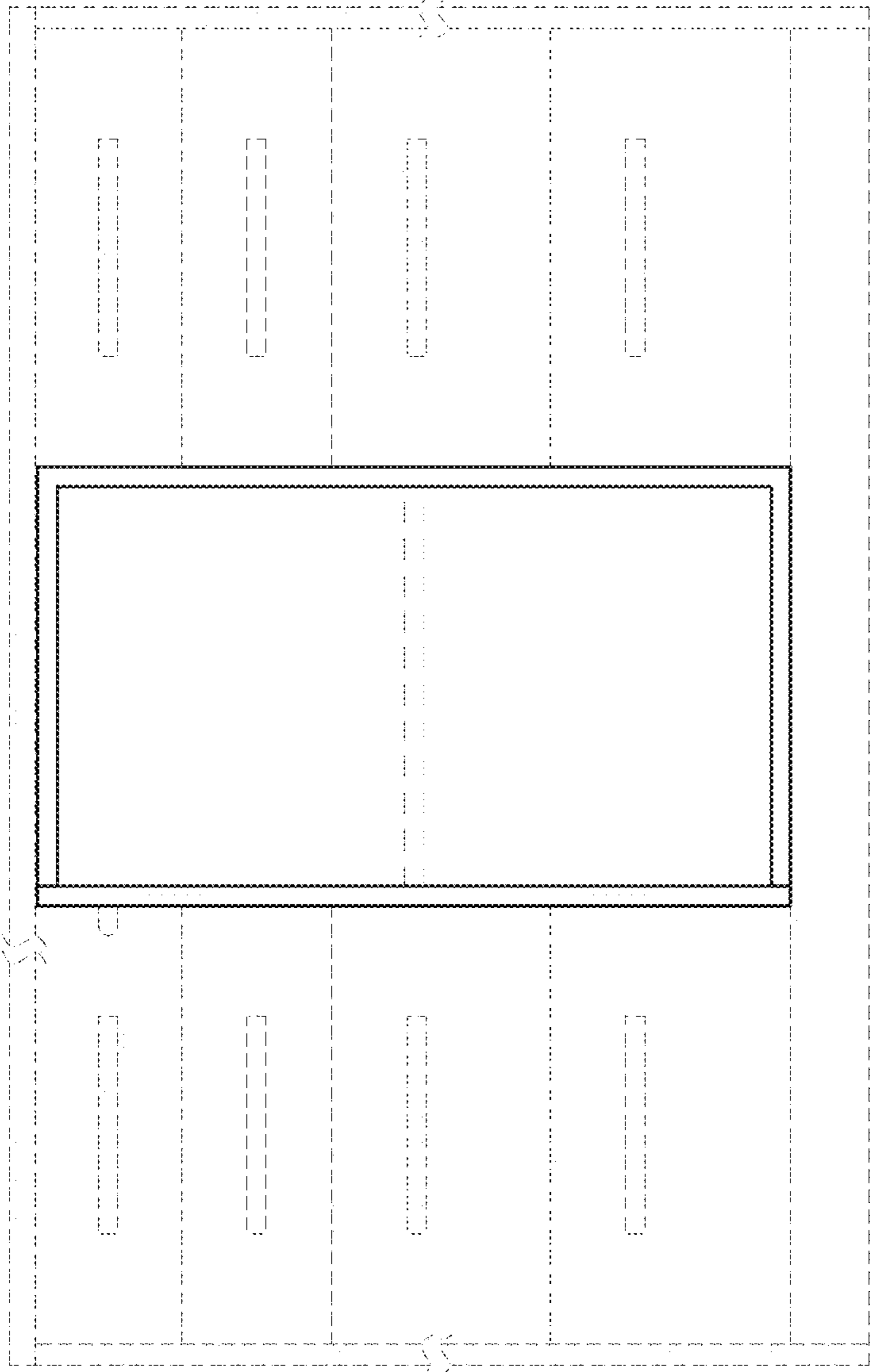

FIG. 9

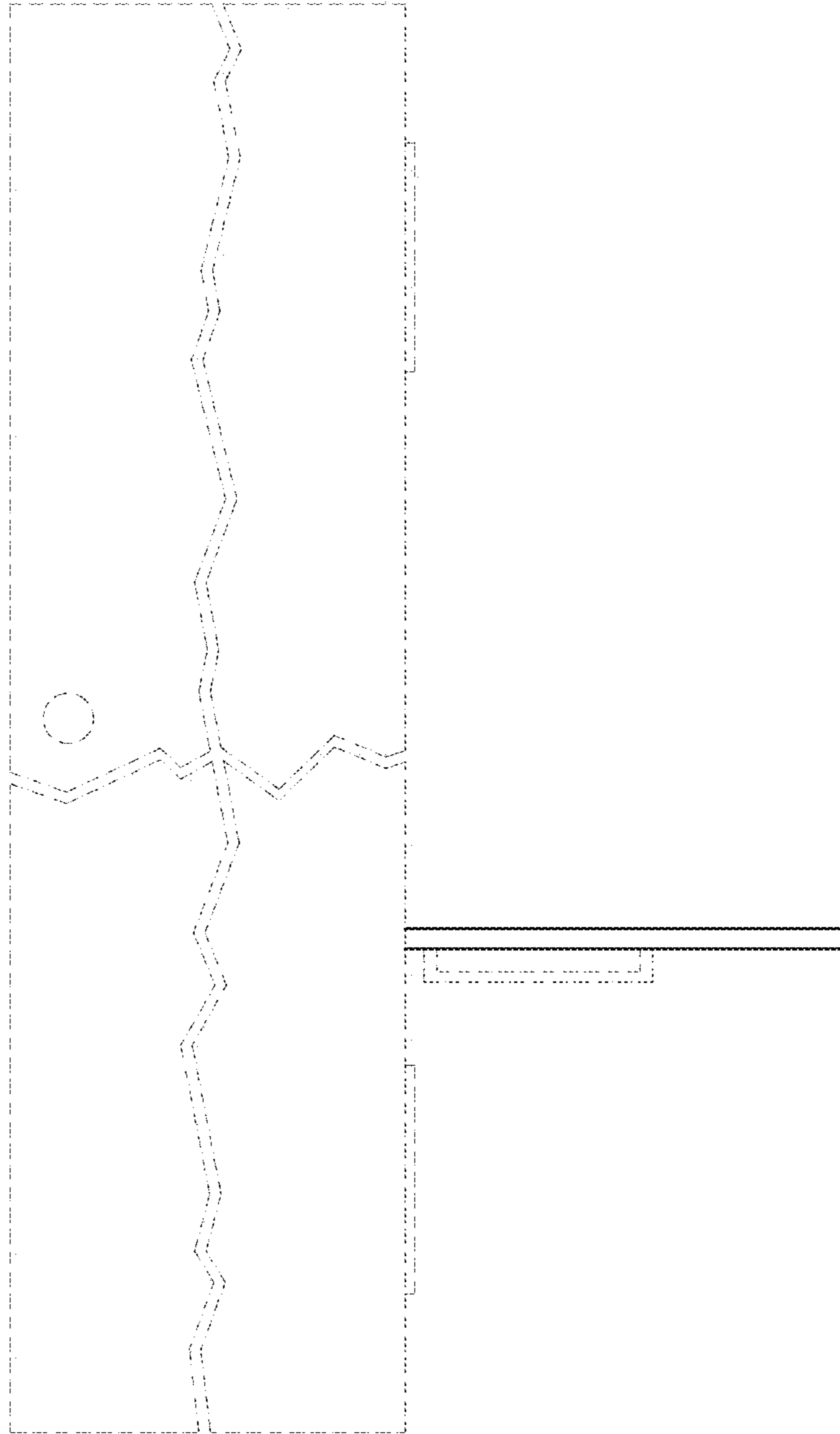

FIG. 10

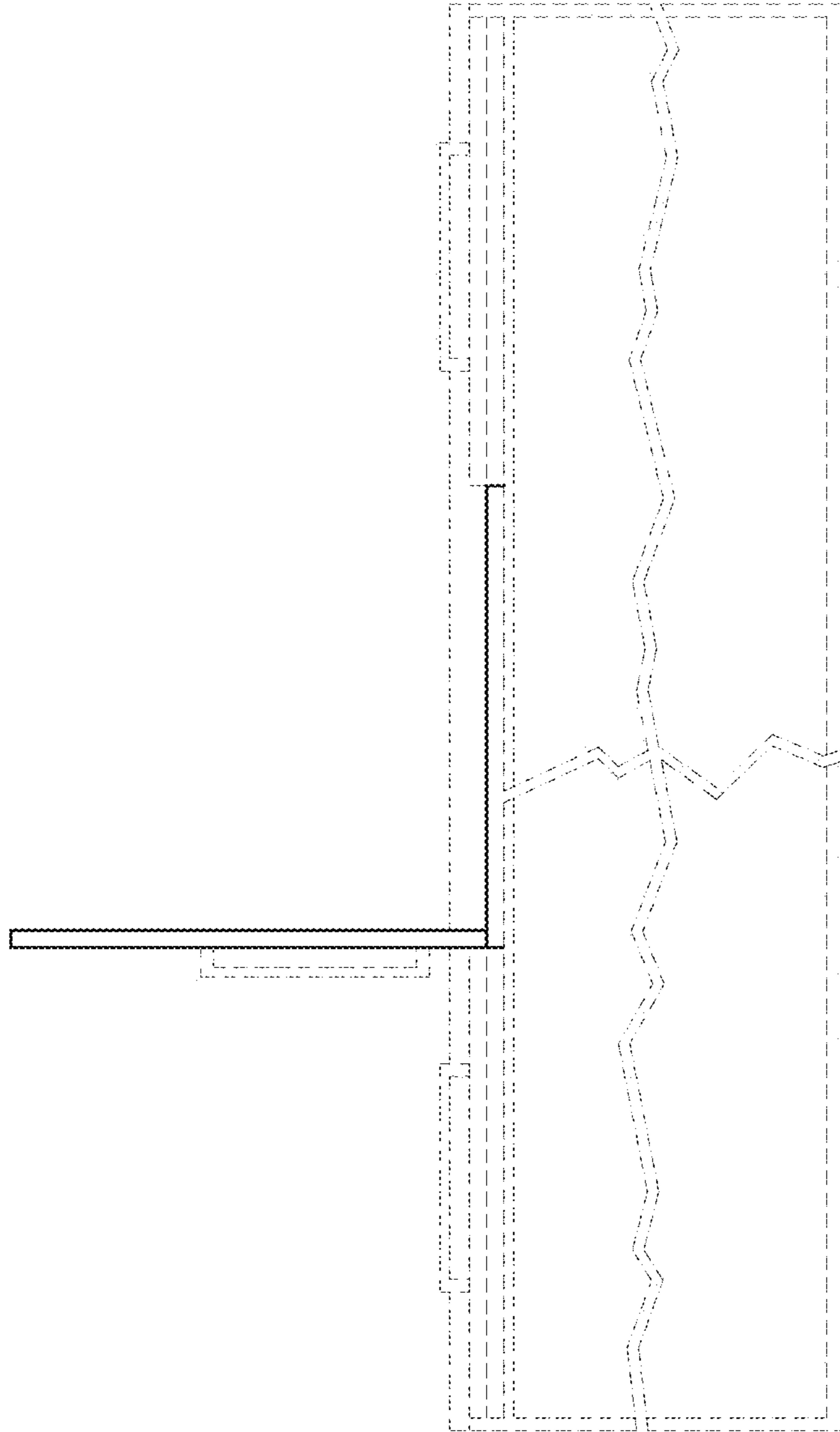

FIG. 11

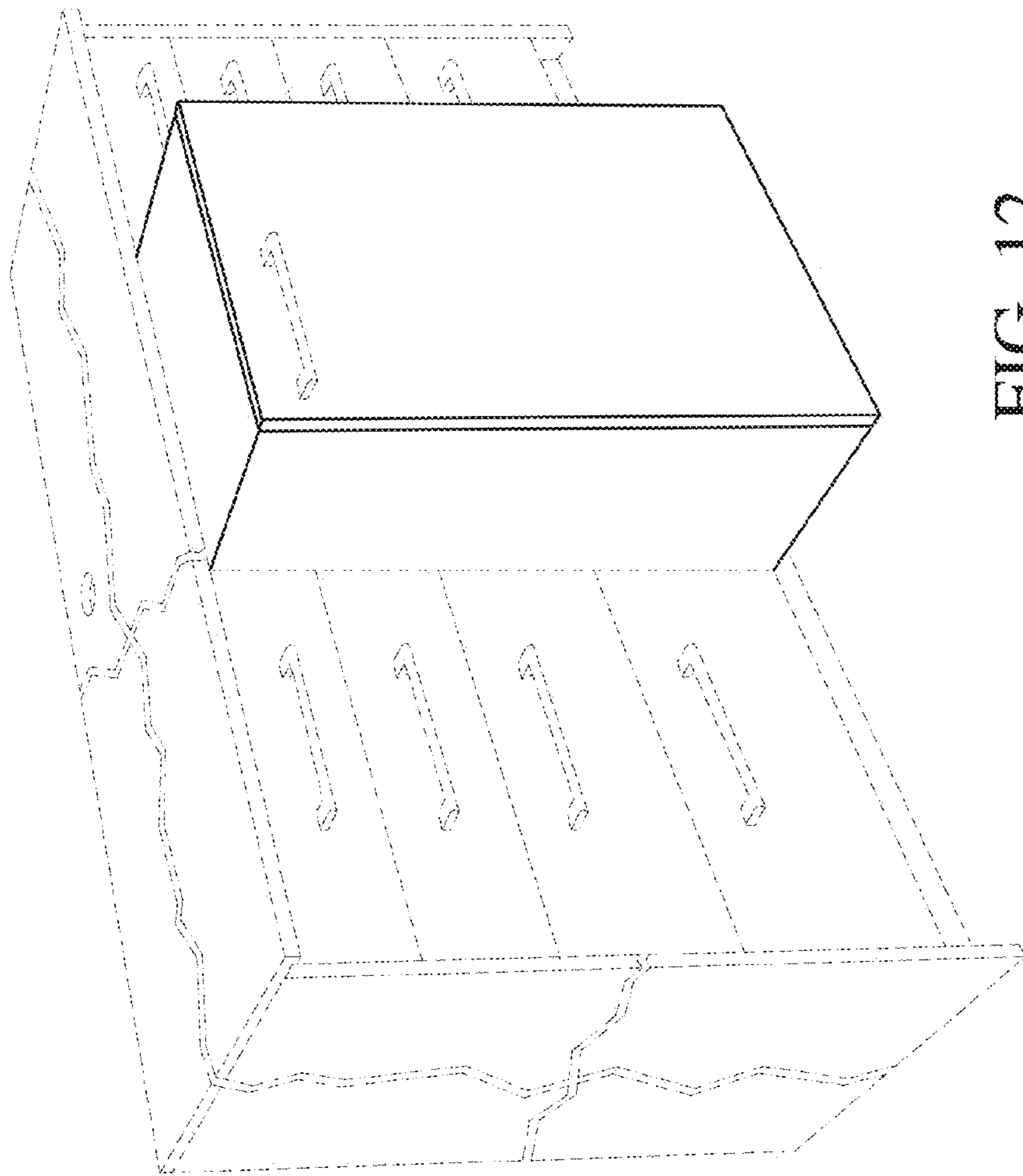

FIG. 12

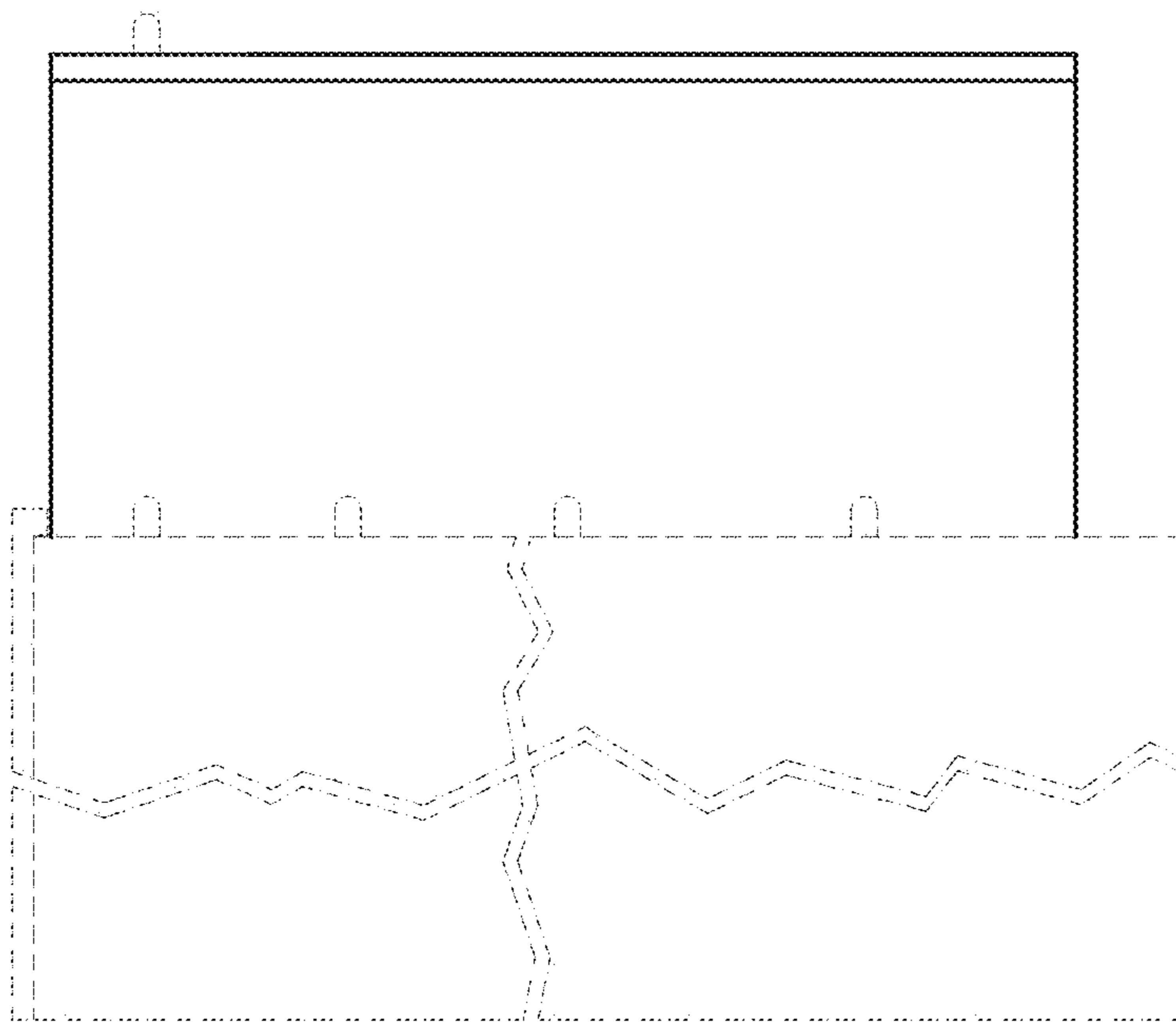

FIG. 13

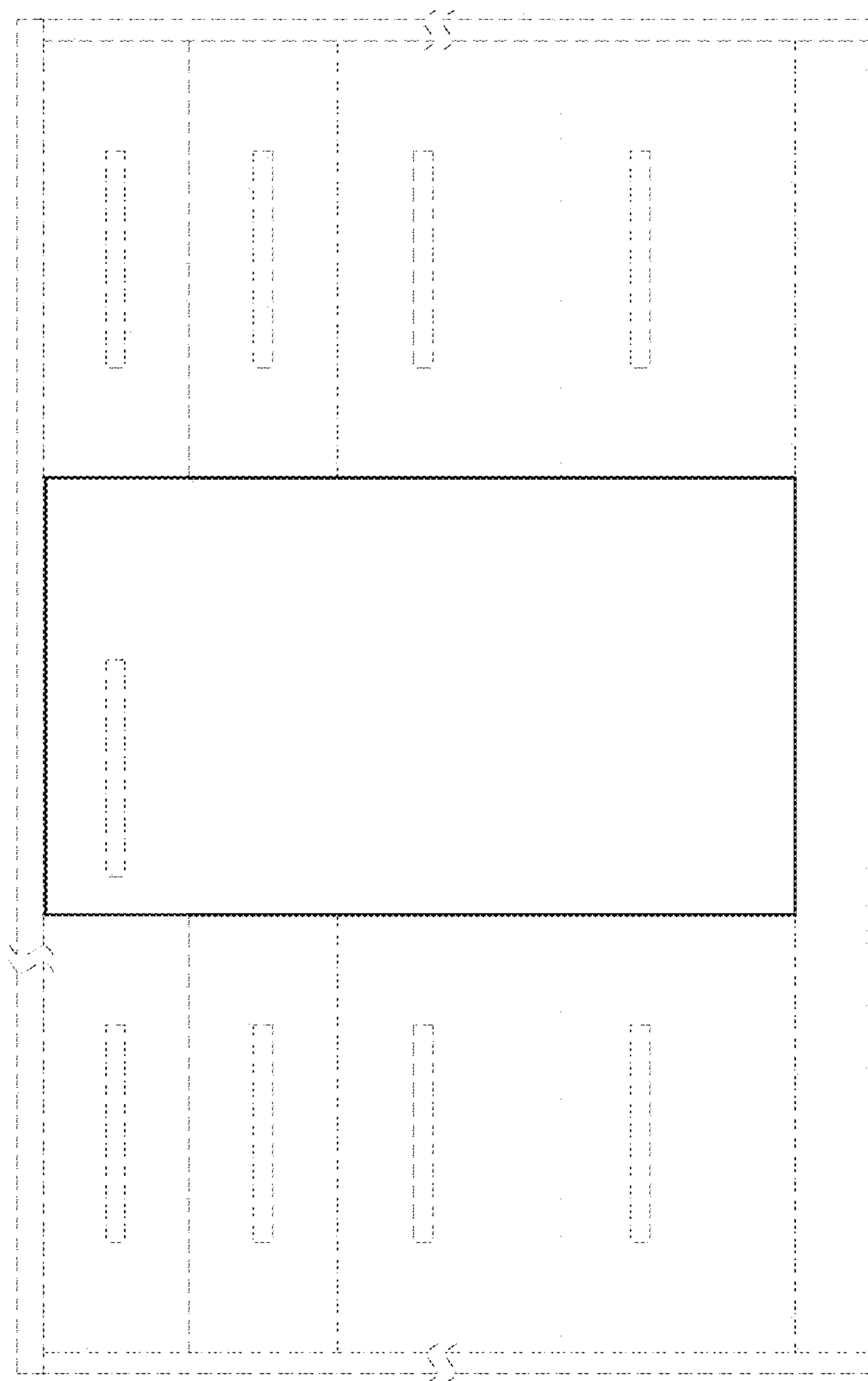

FIG. 14

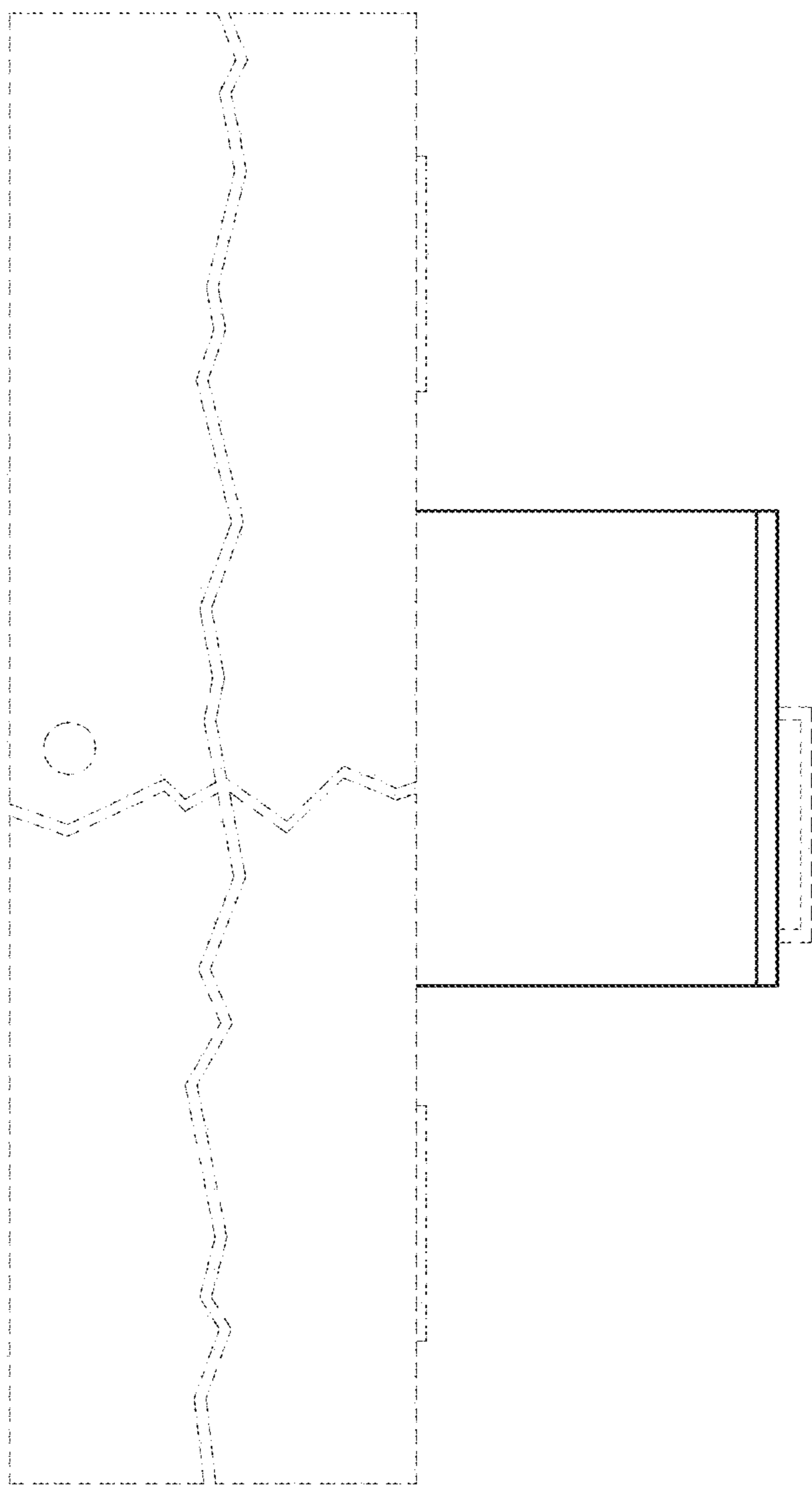

FIG. 15

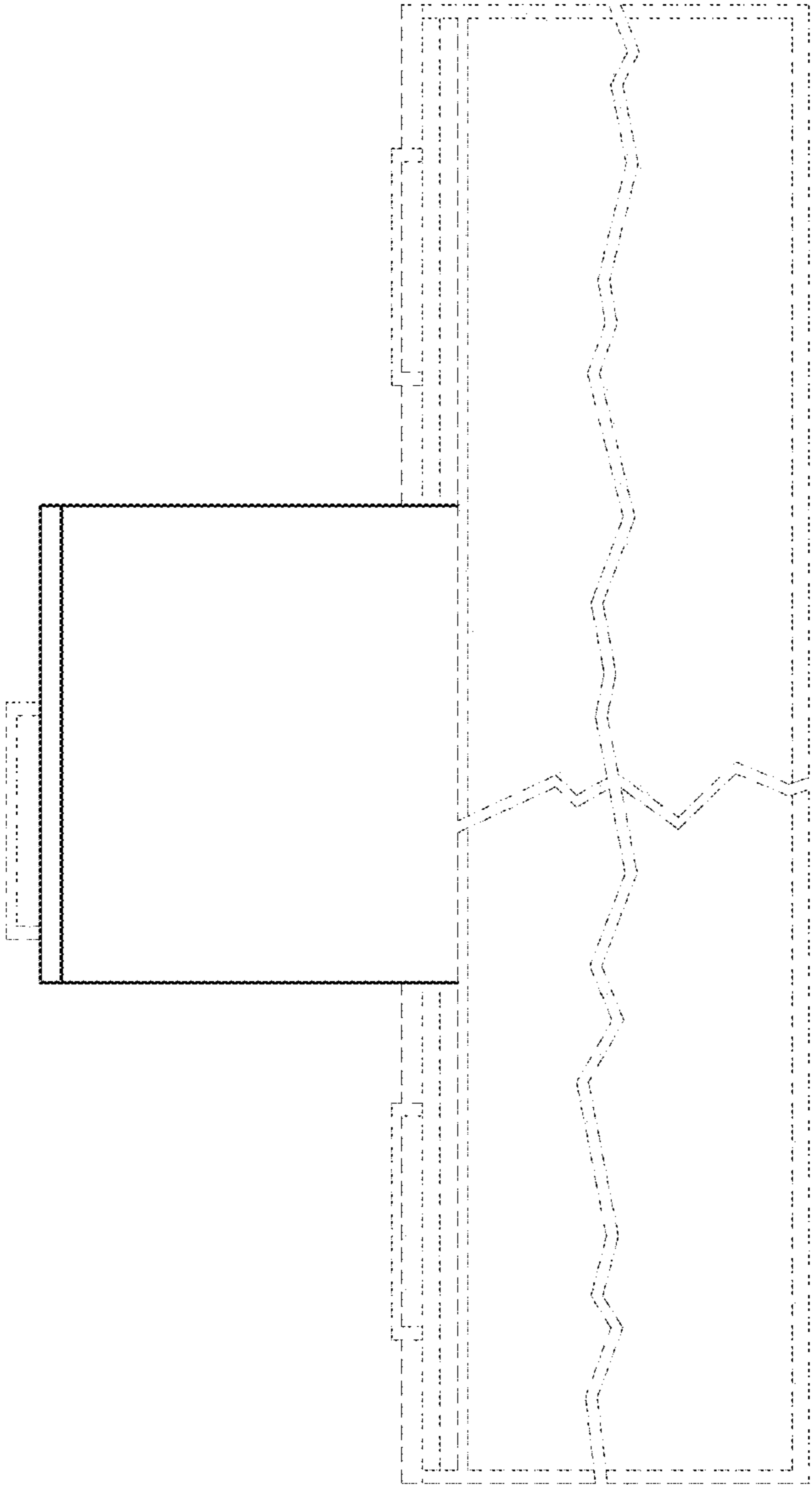

FIG. 16

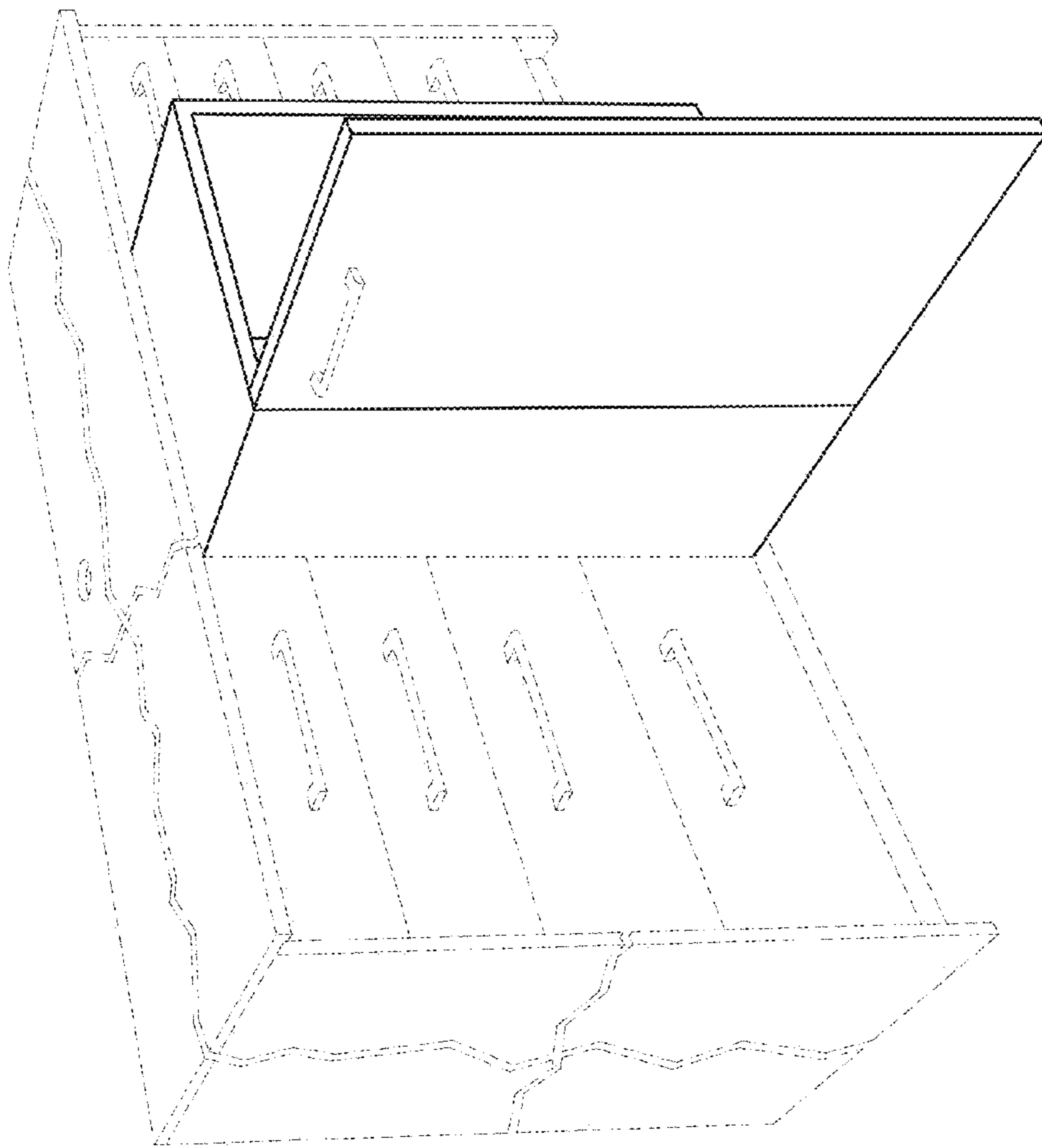

FIG. 17

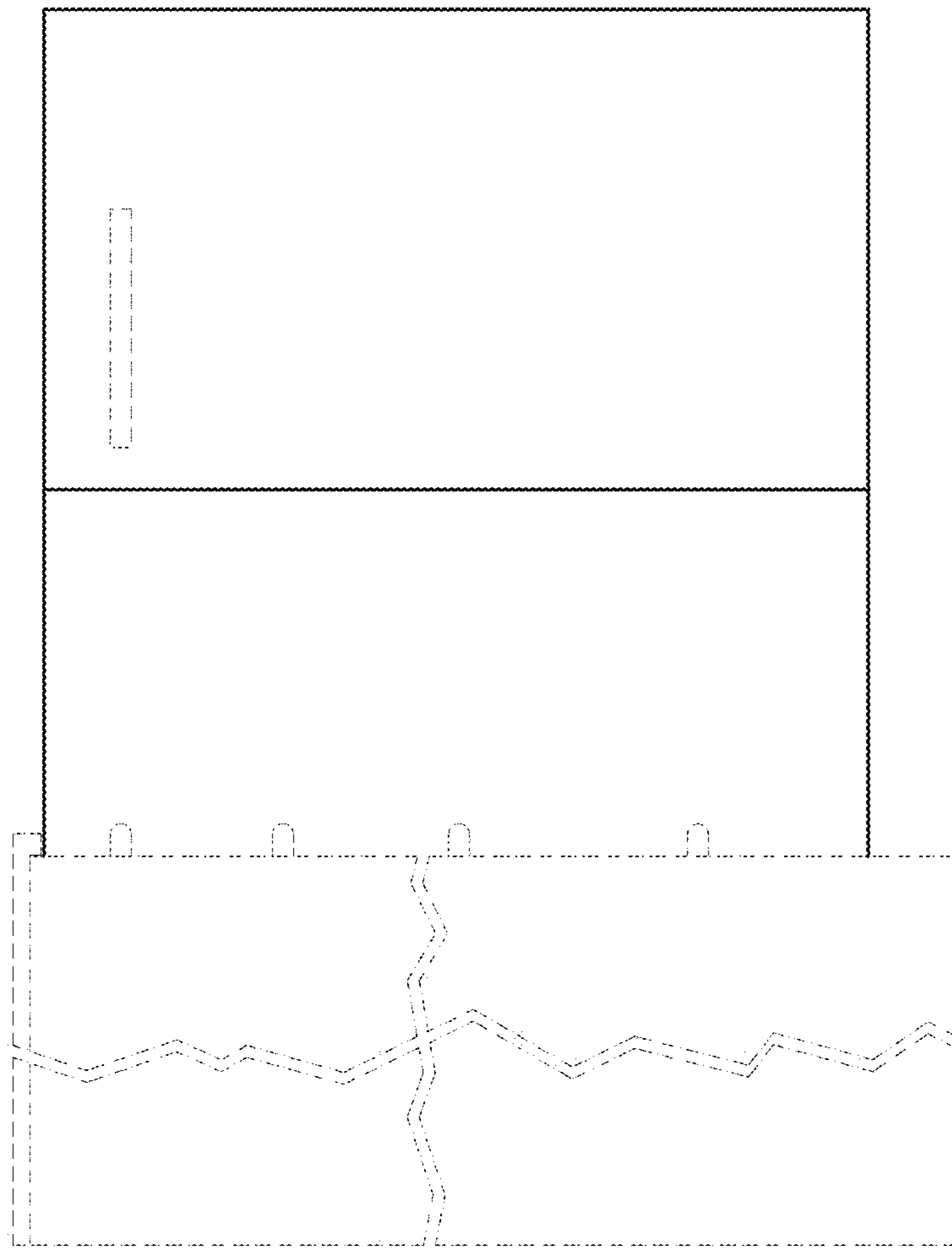

FIG. 18

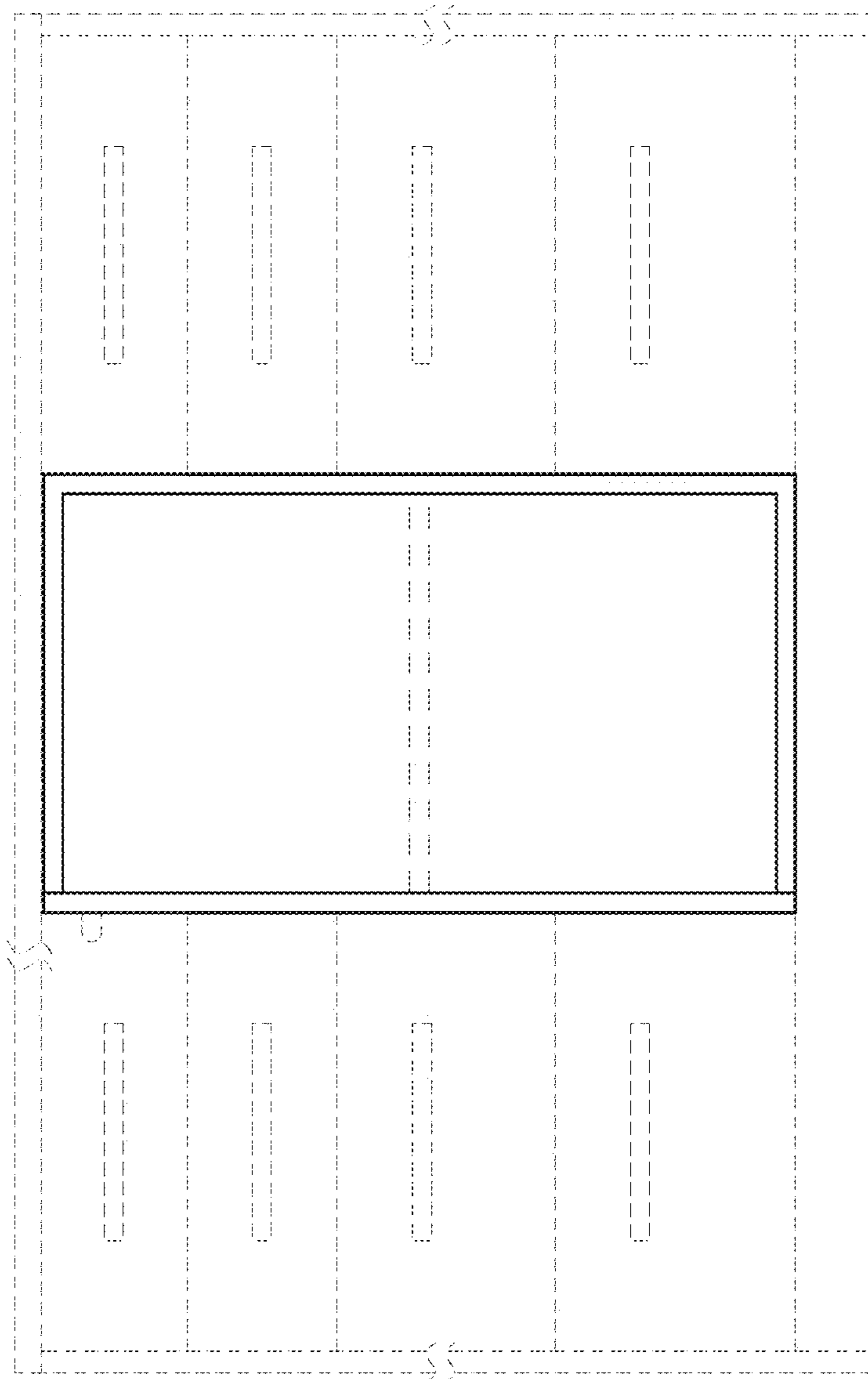

FIG. 19

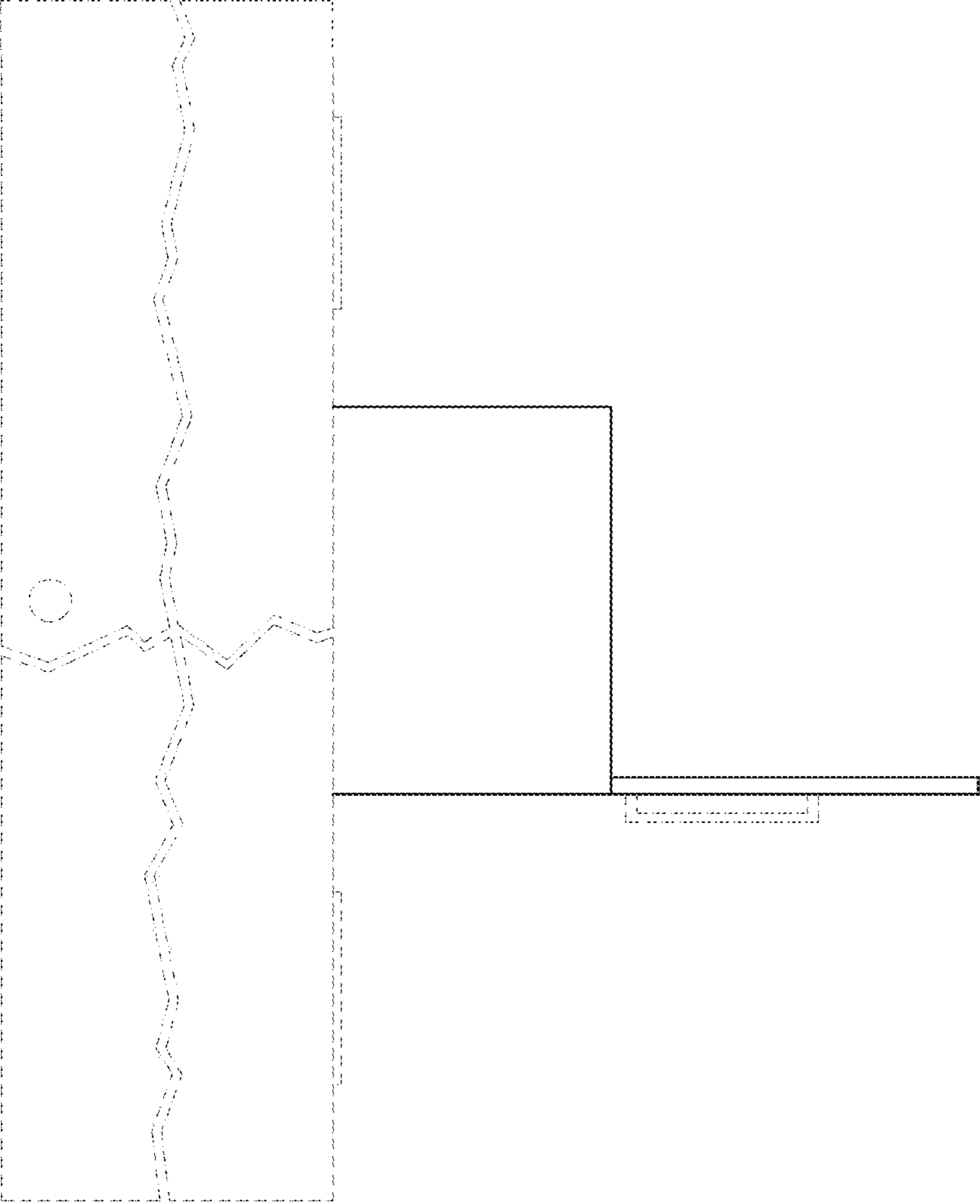

FIG. 20

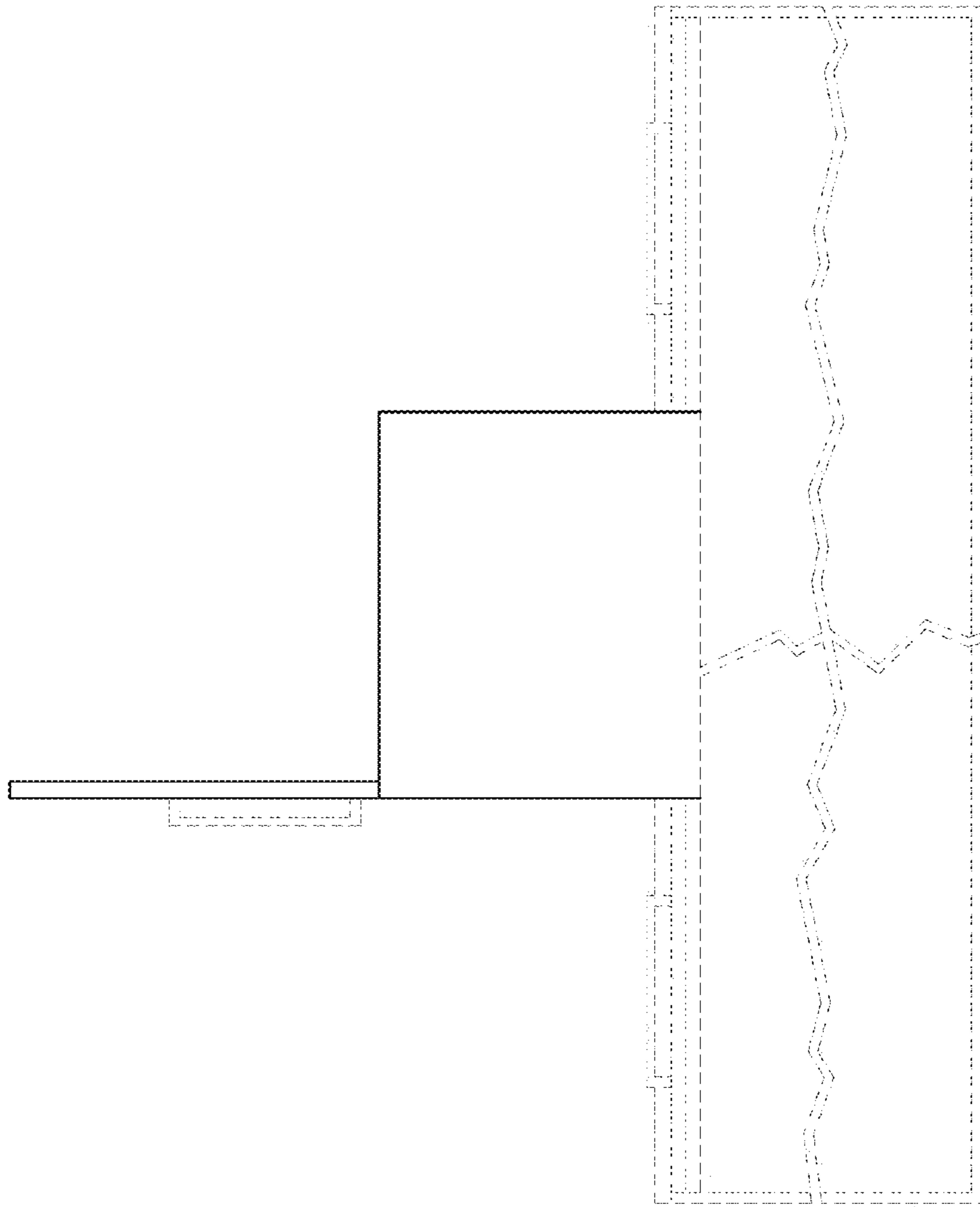

FIG. 21

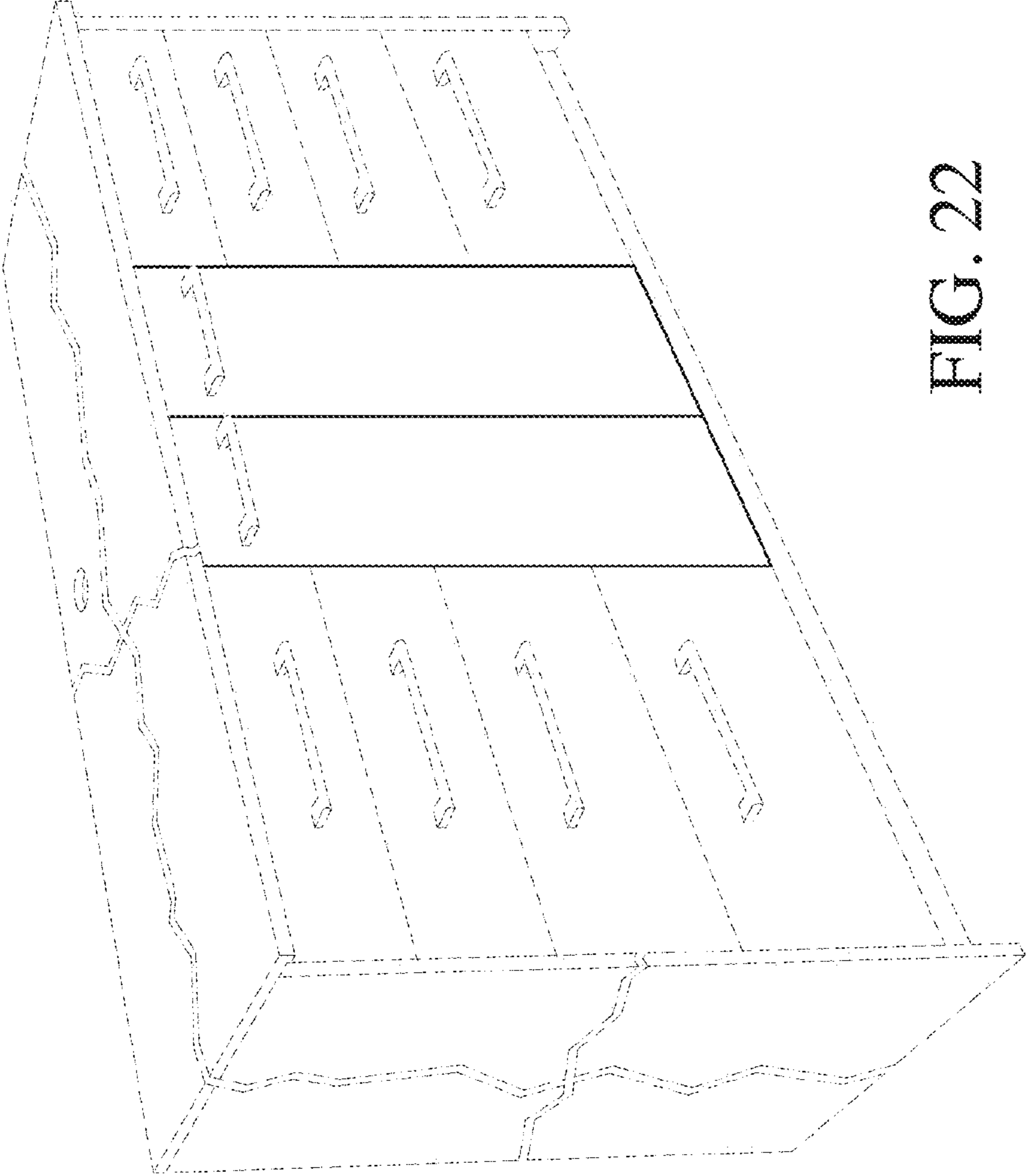

FIG. 22

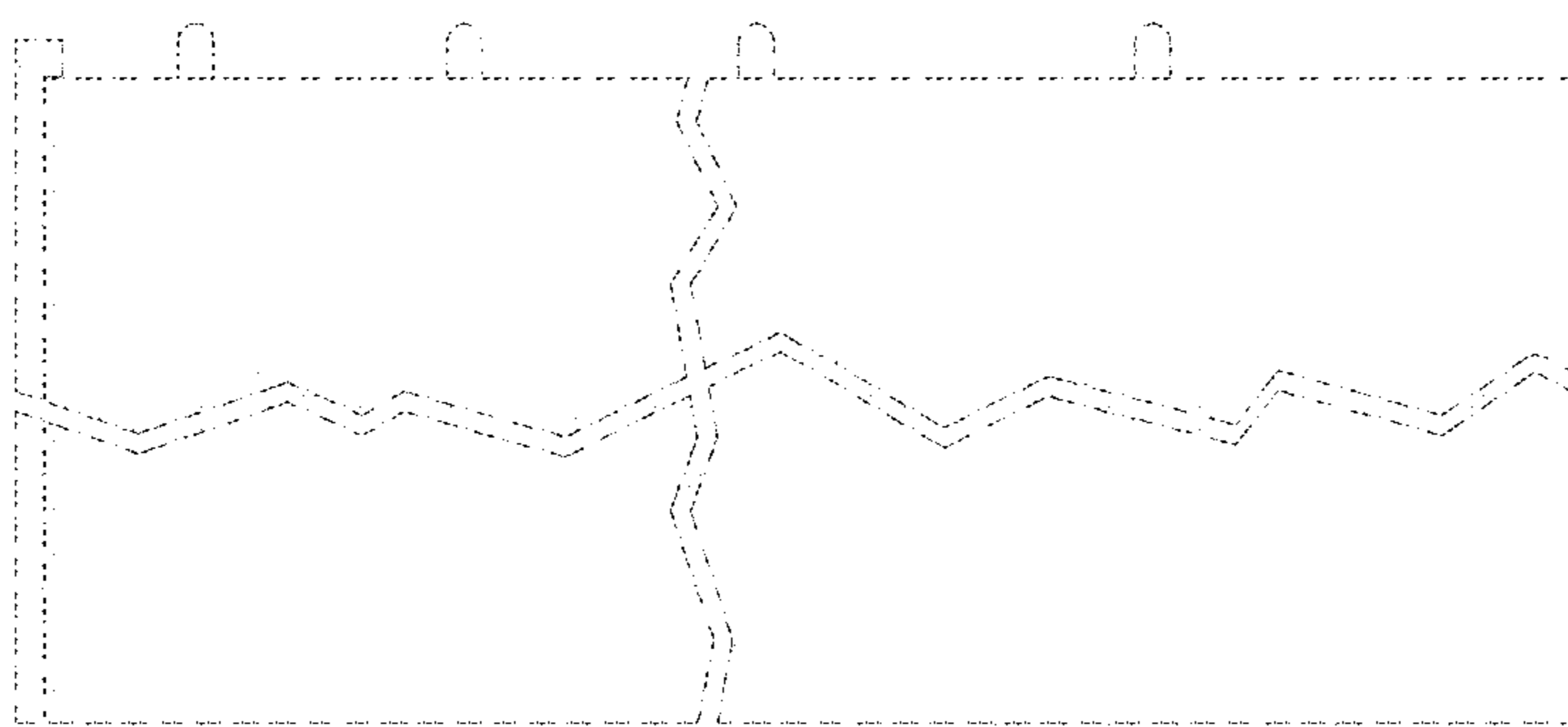

FIG. 23

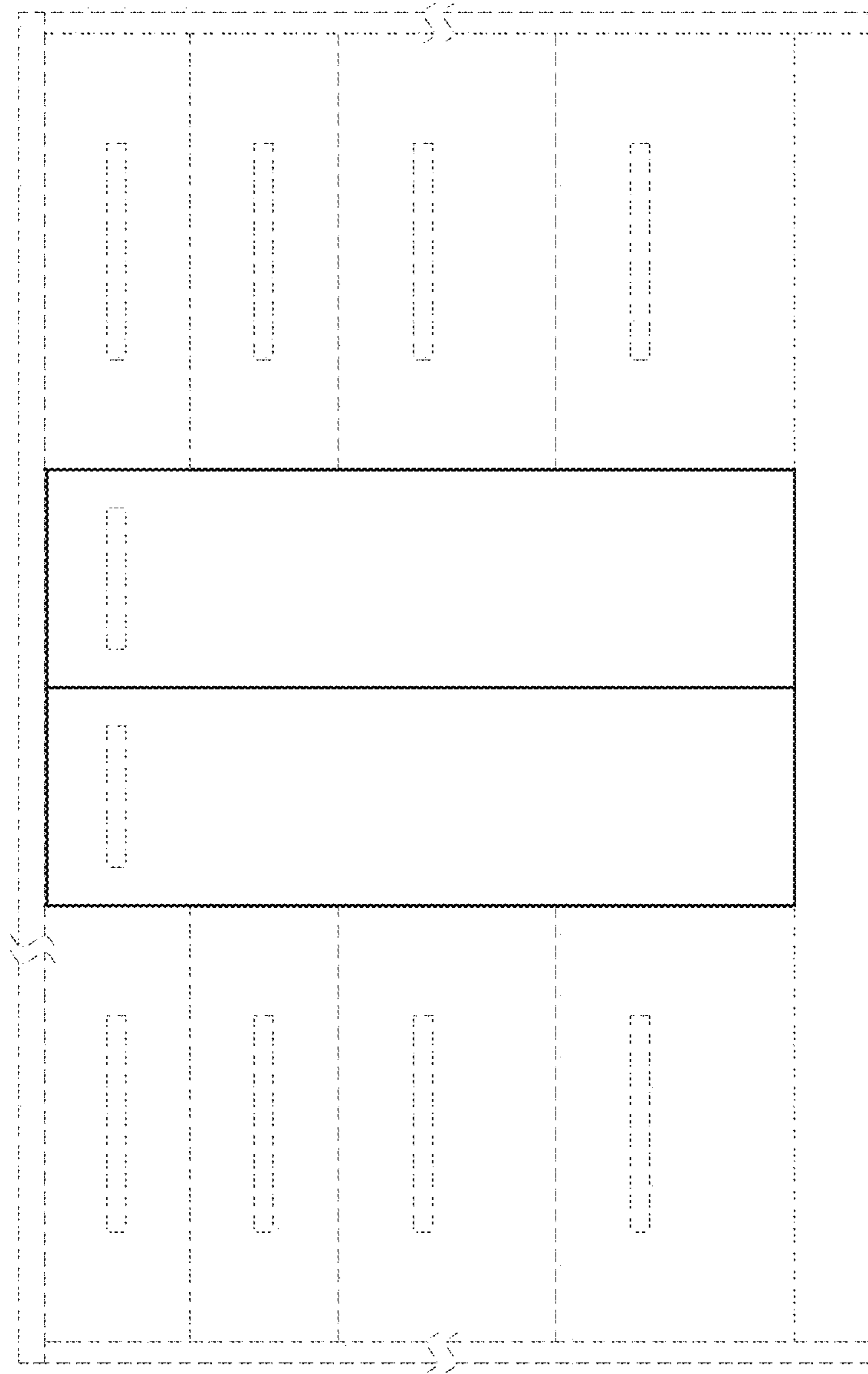

FIG. 24

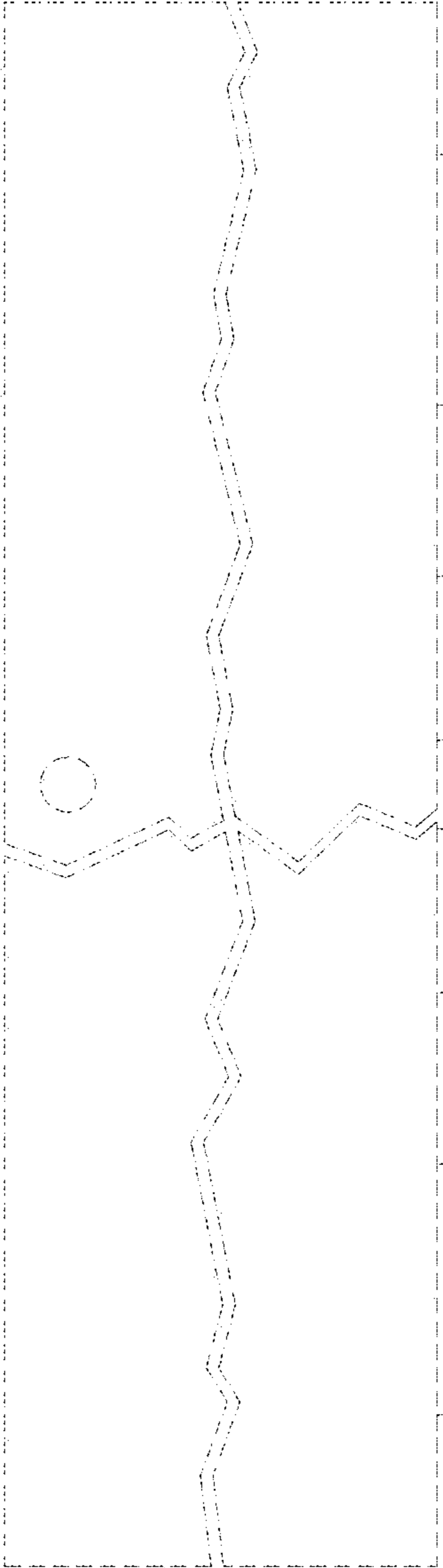

FIG. 25

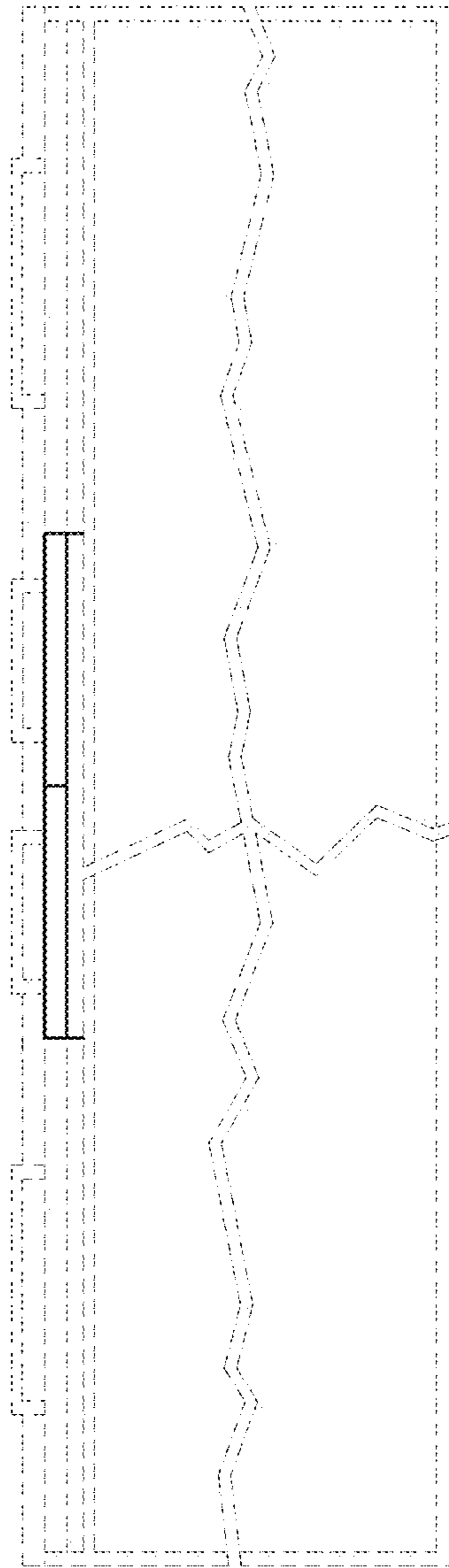

FIG. 26

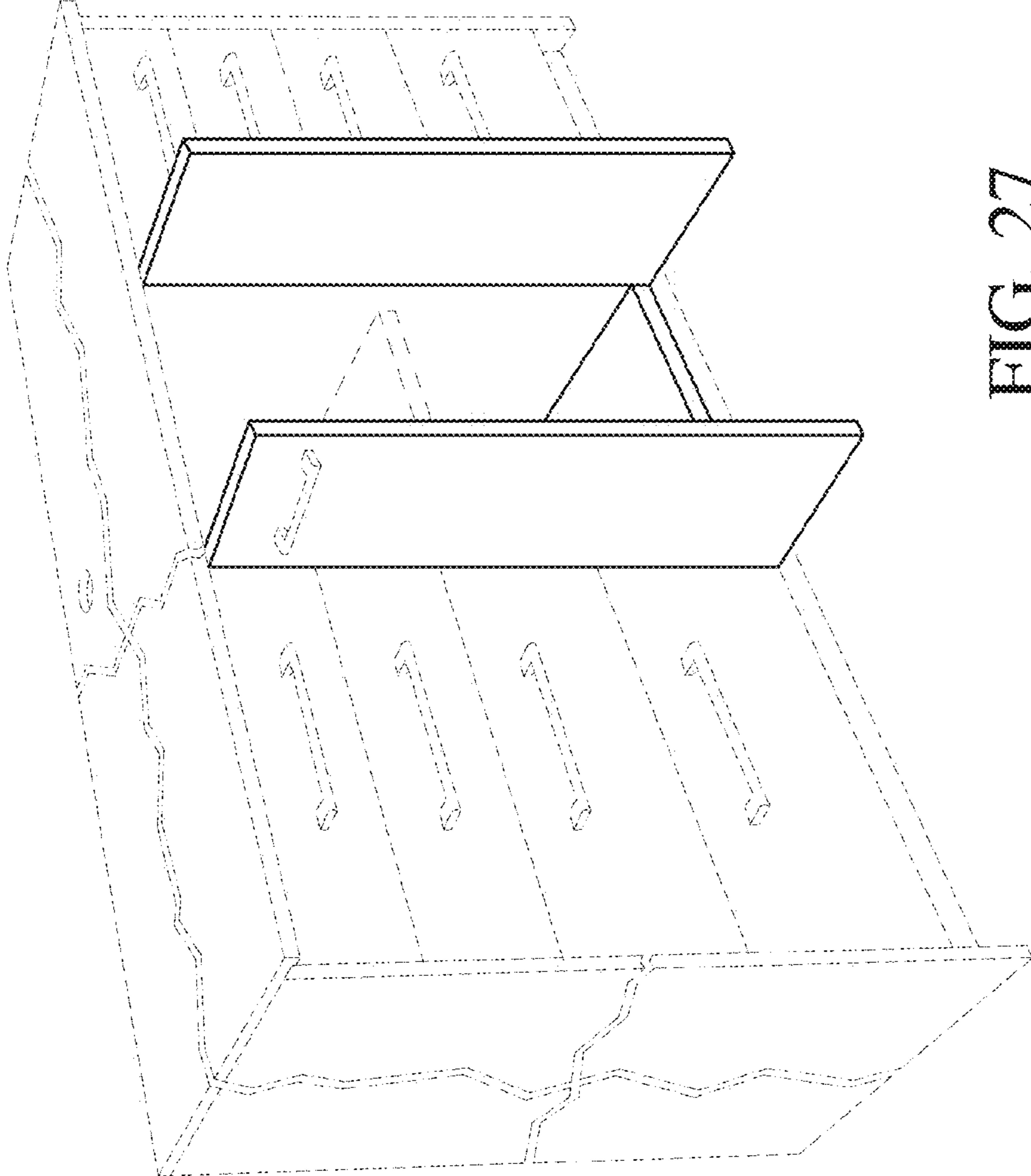

FIG. 27

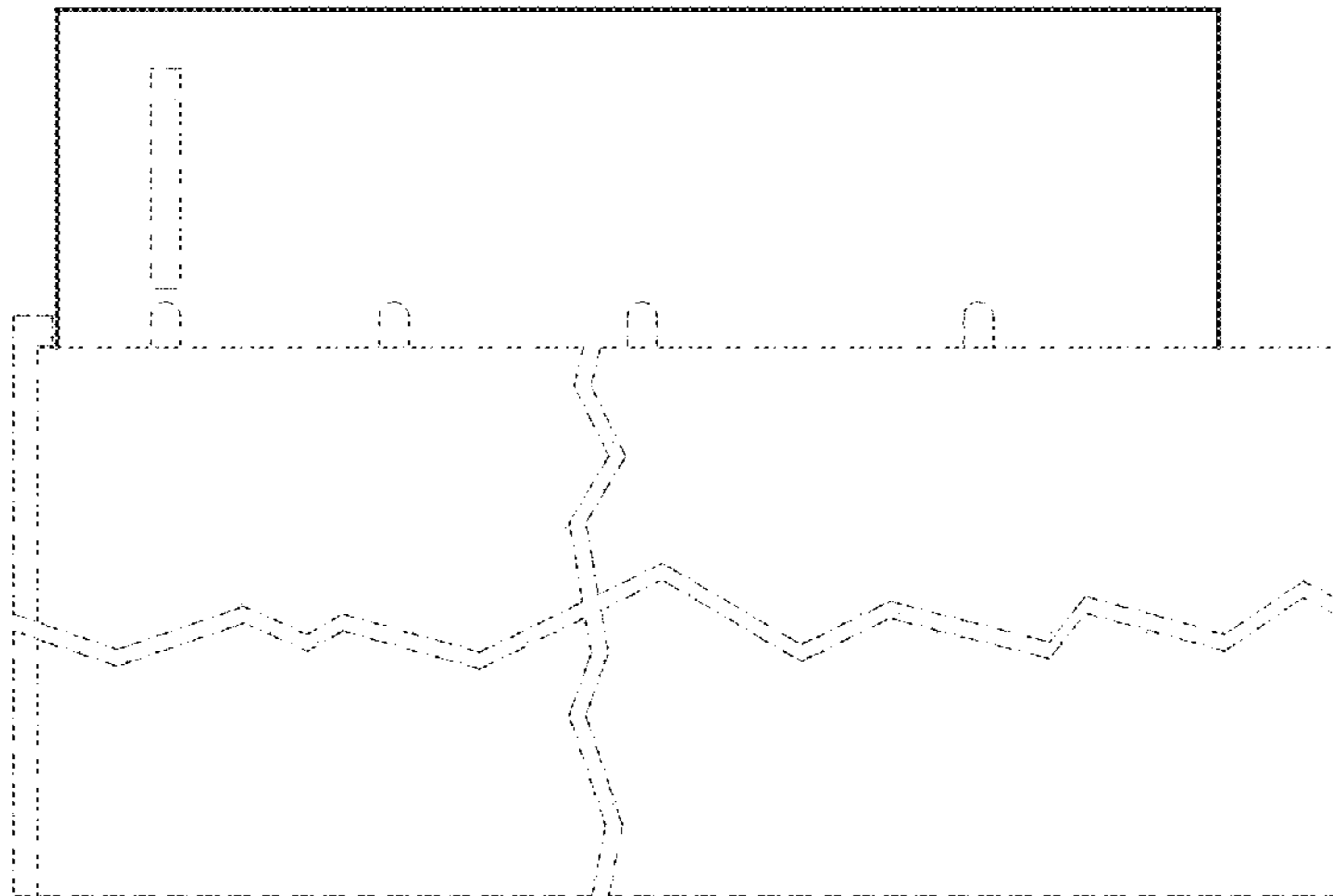

FIG. 28

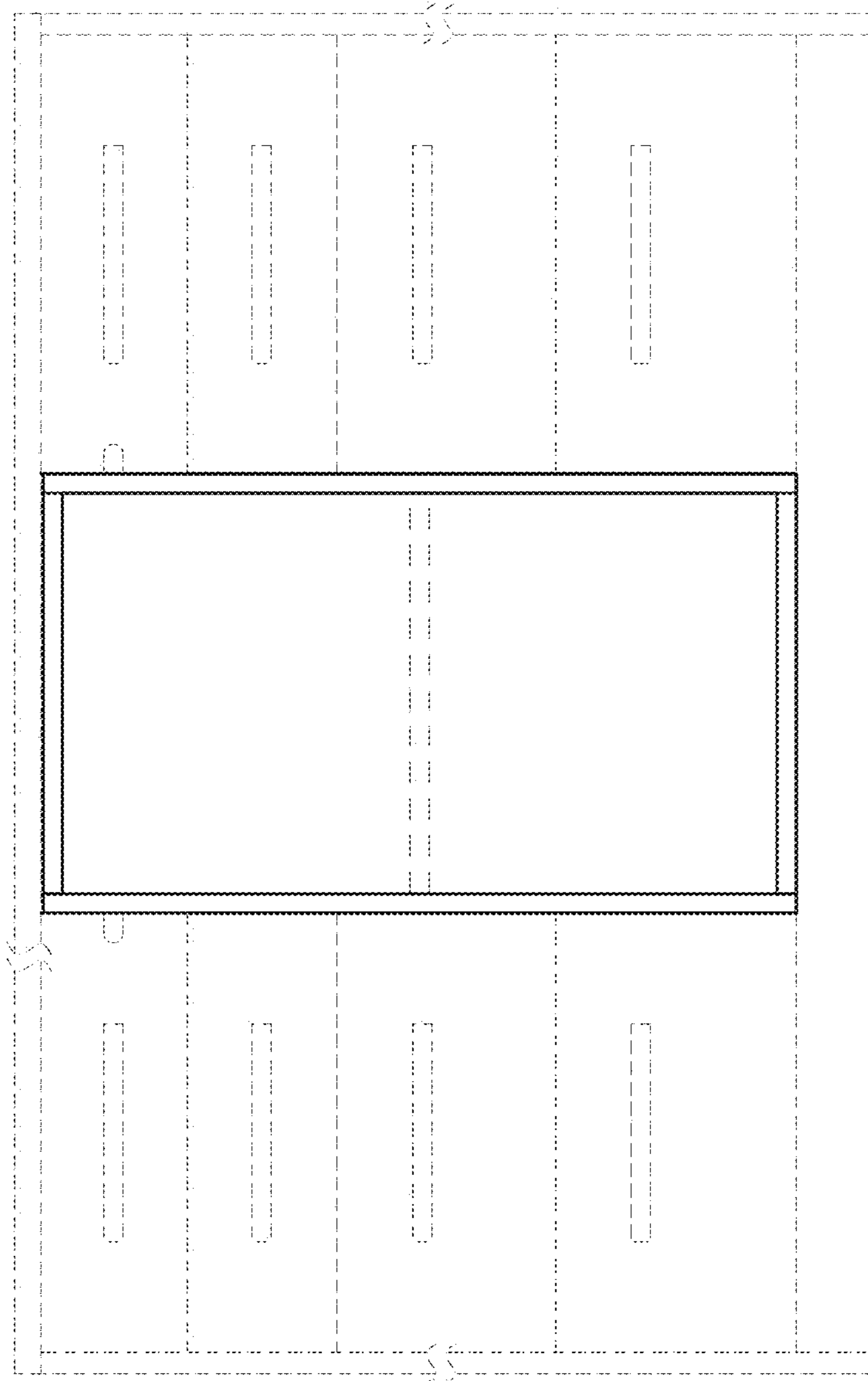

FIG. 29

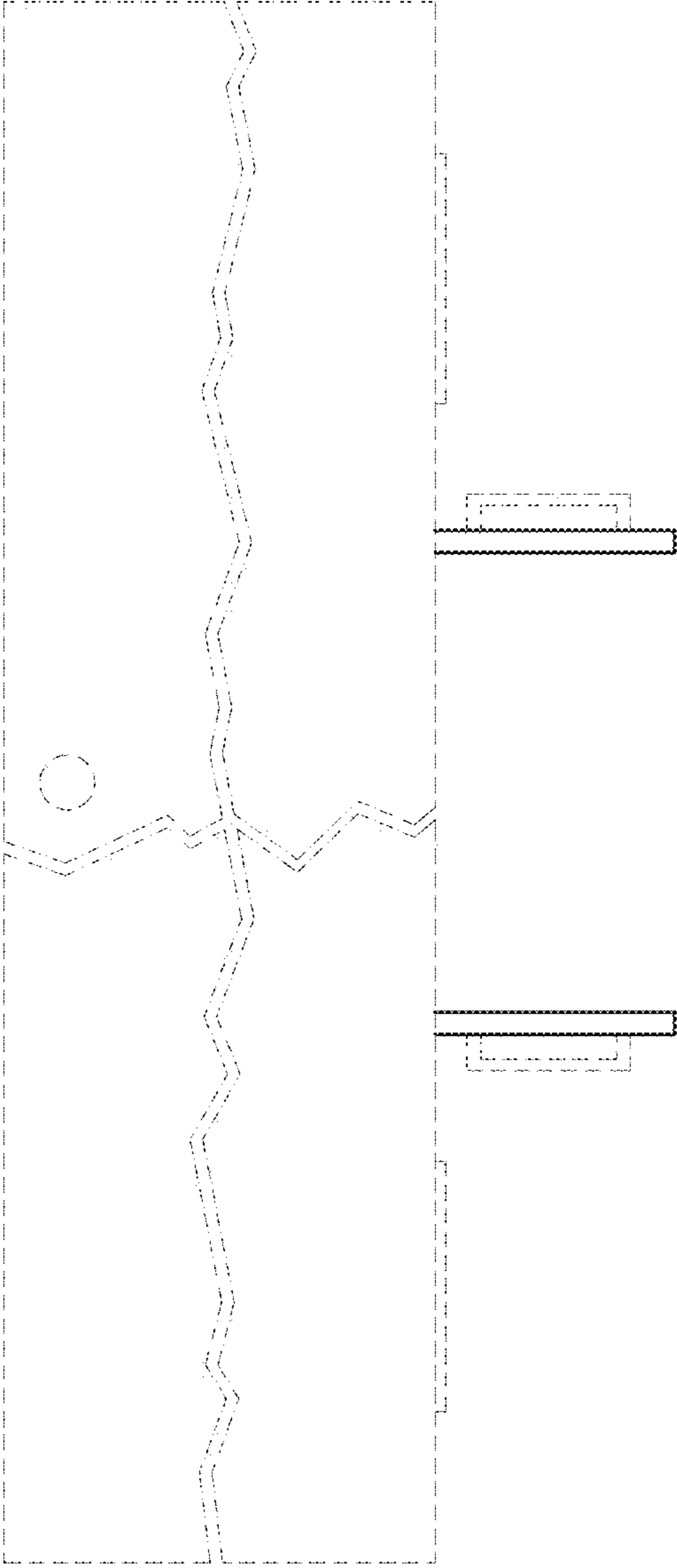

FIG. 30

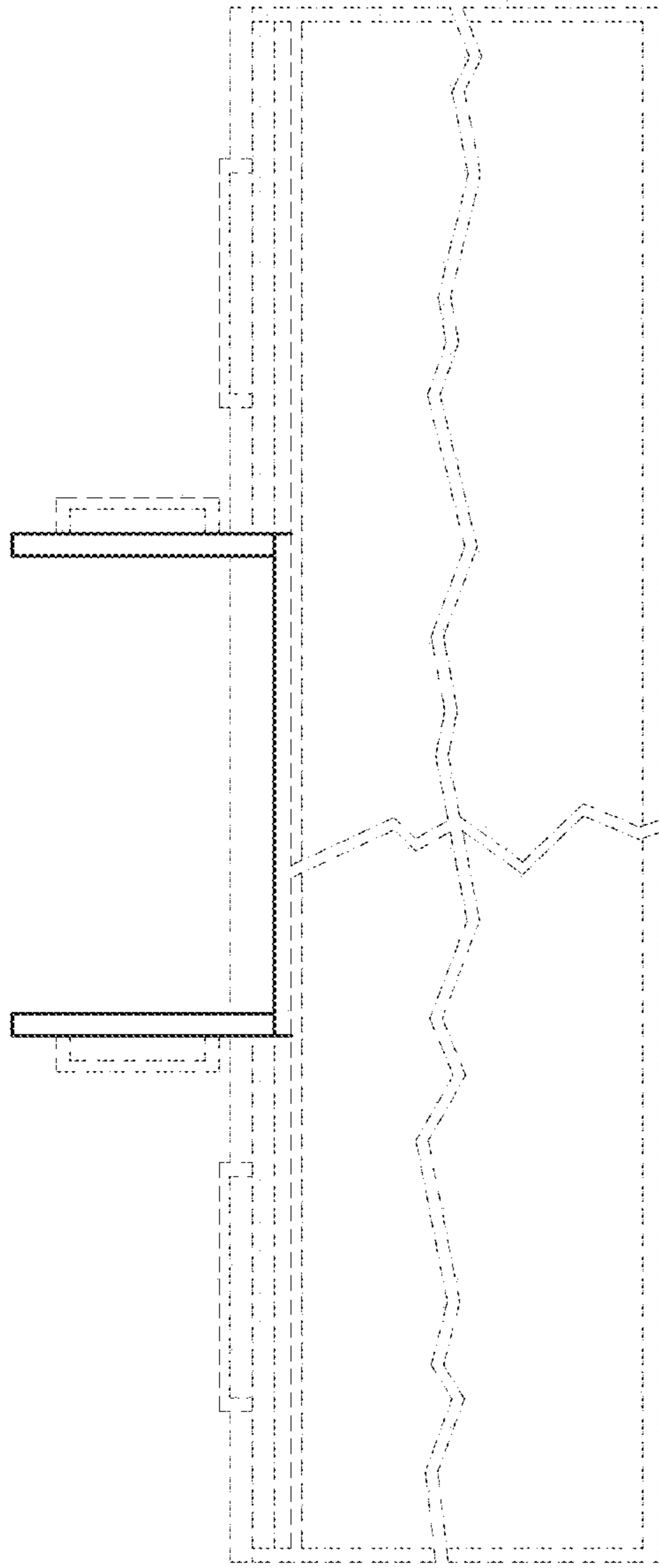

FIG. 31

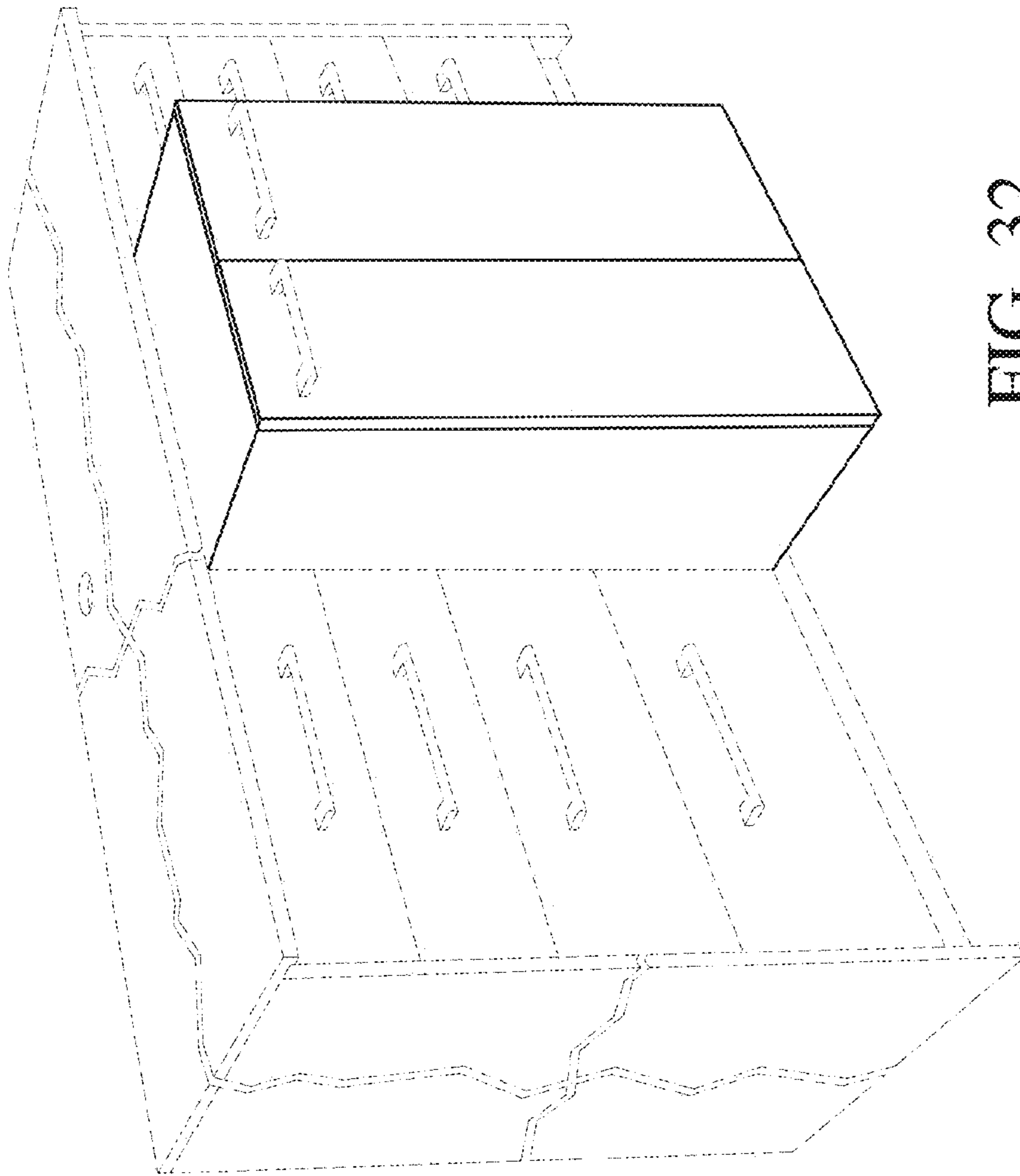

FIG. 32

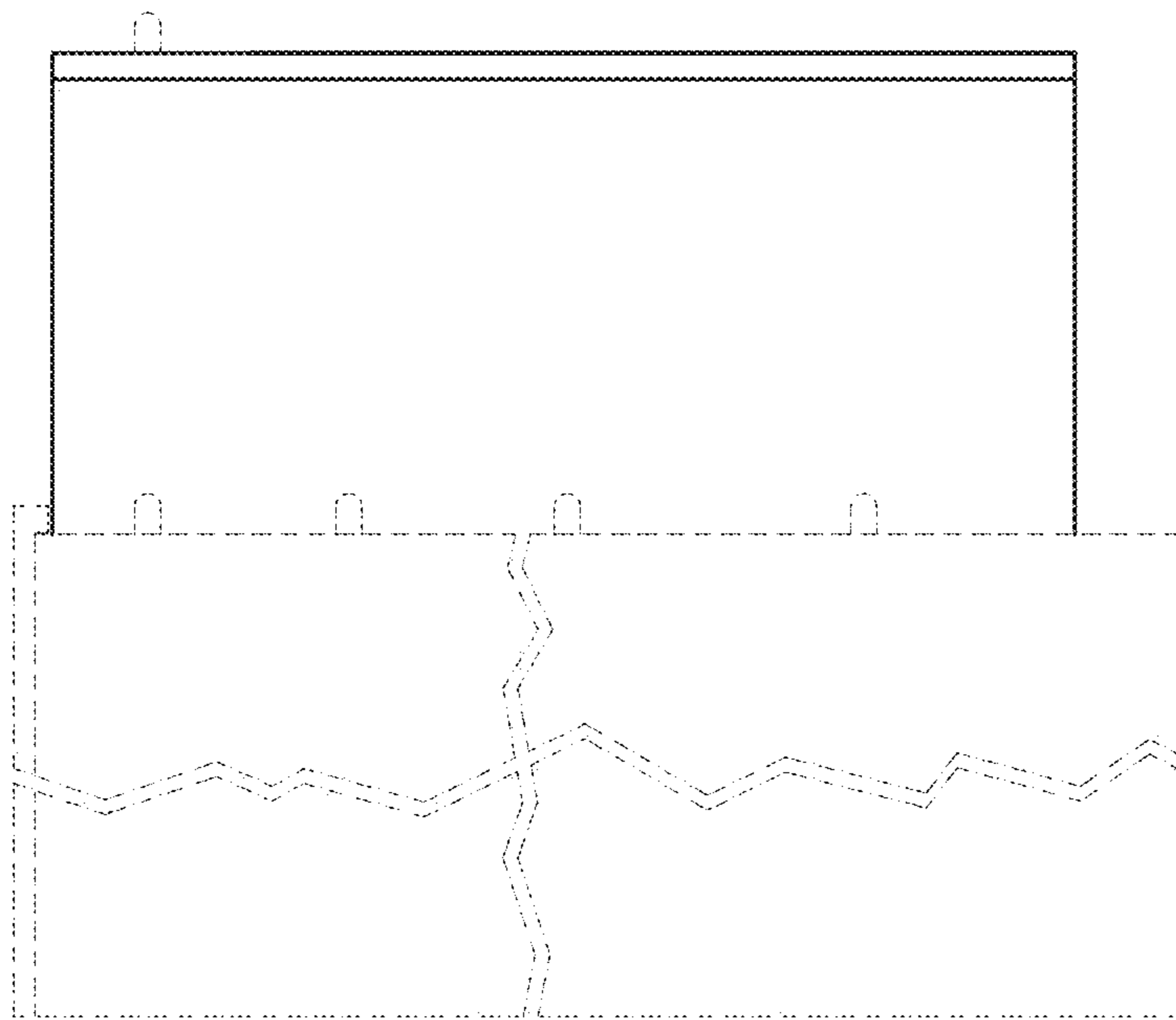

FIG. 33

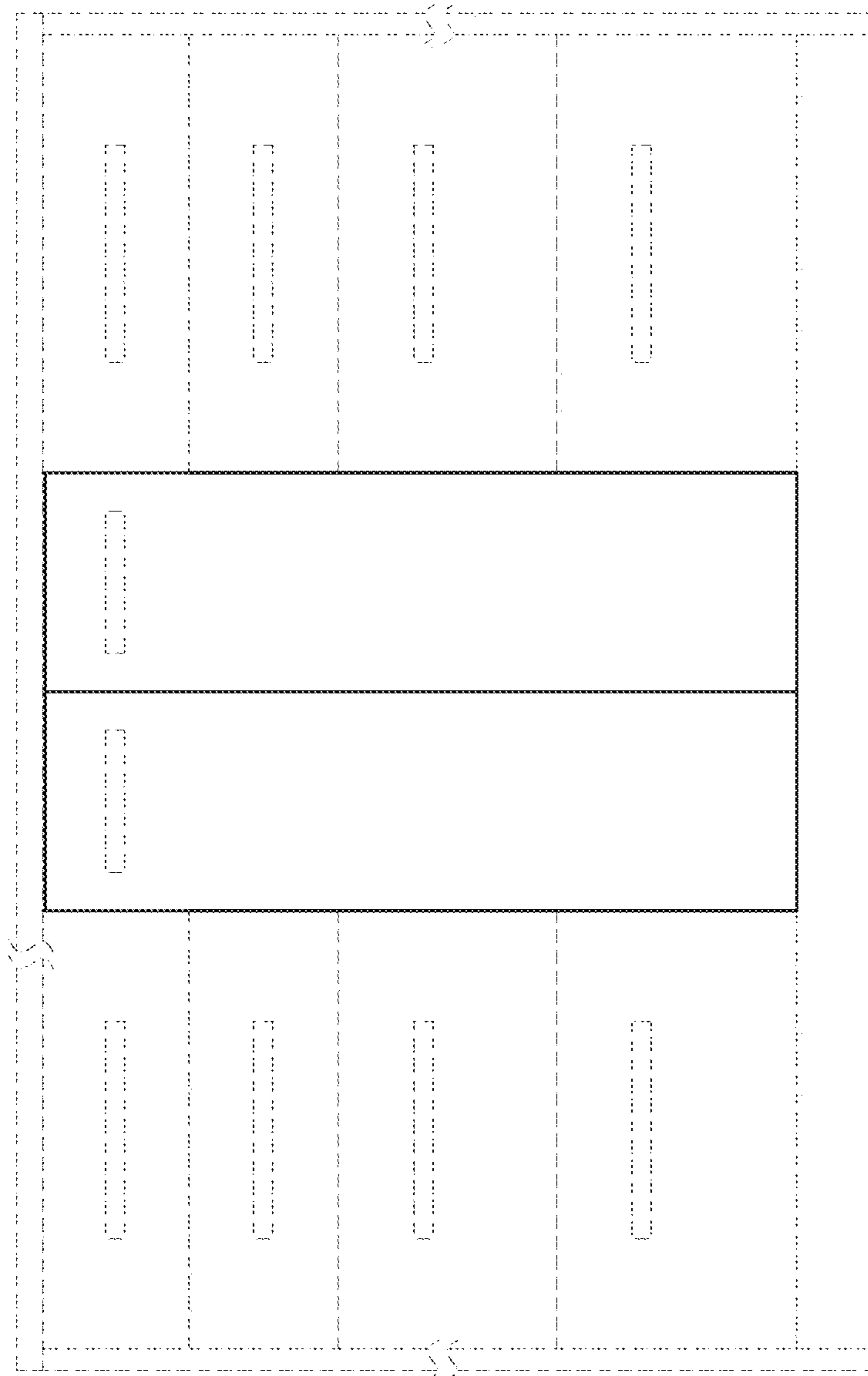

FIG. 34

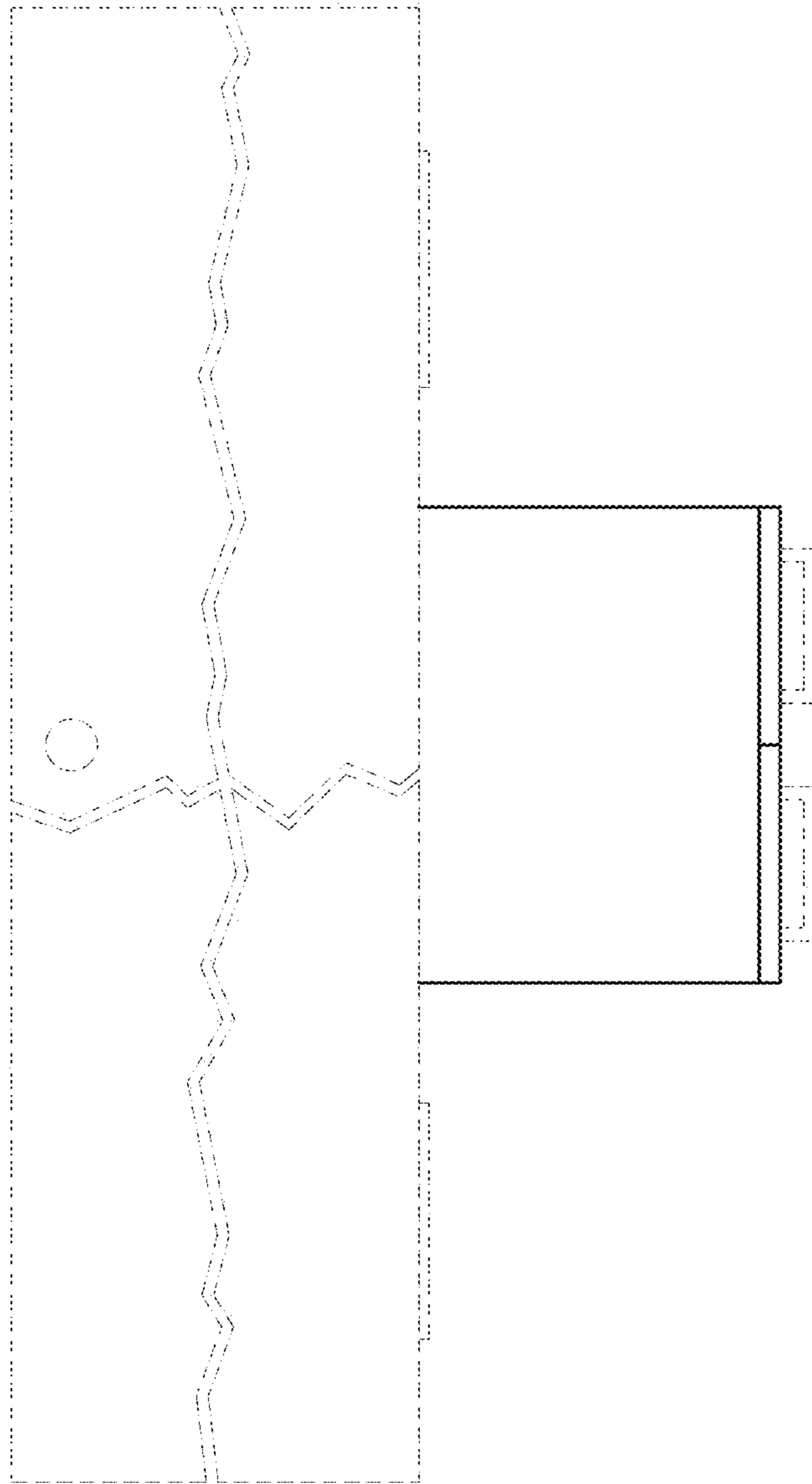

FIG. 35

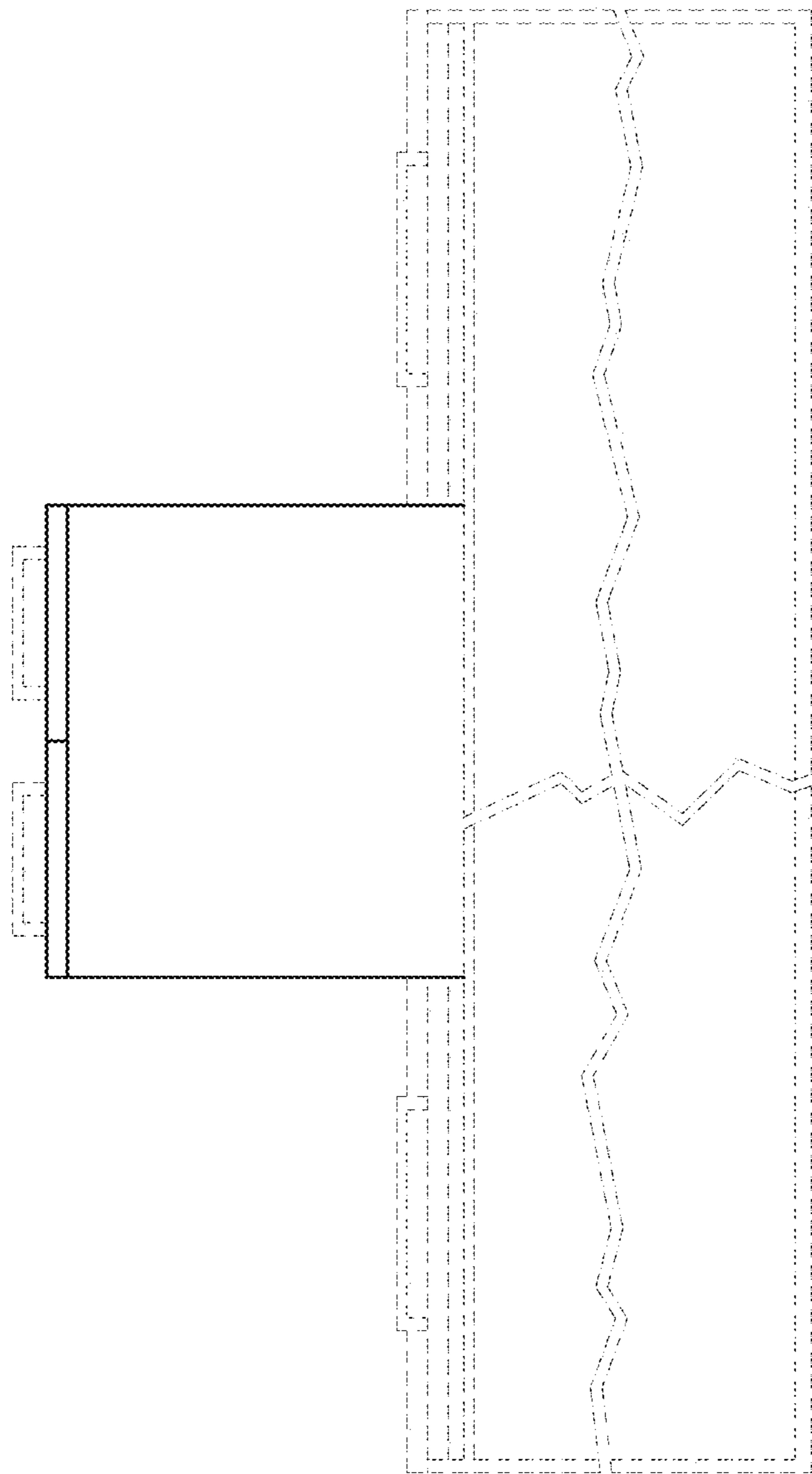

FIG. 36

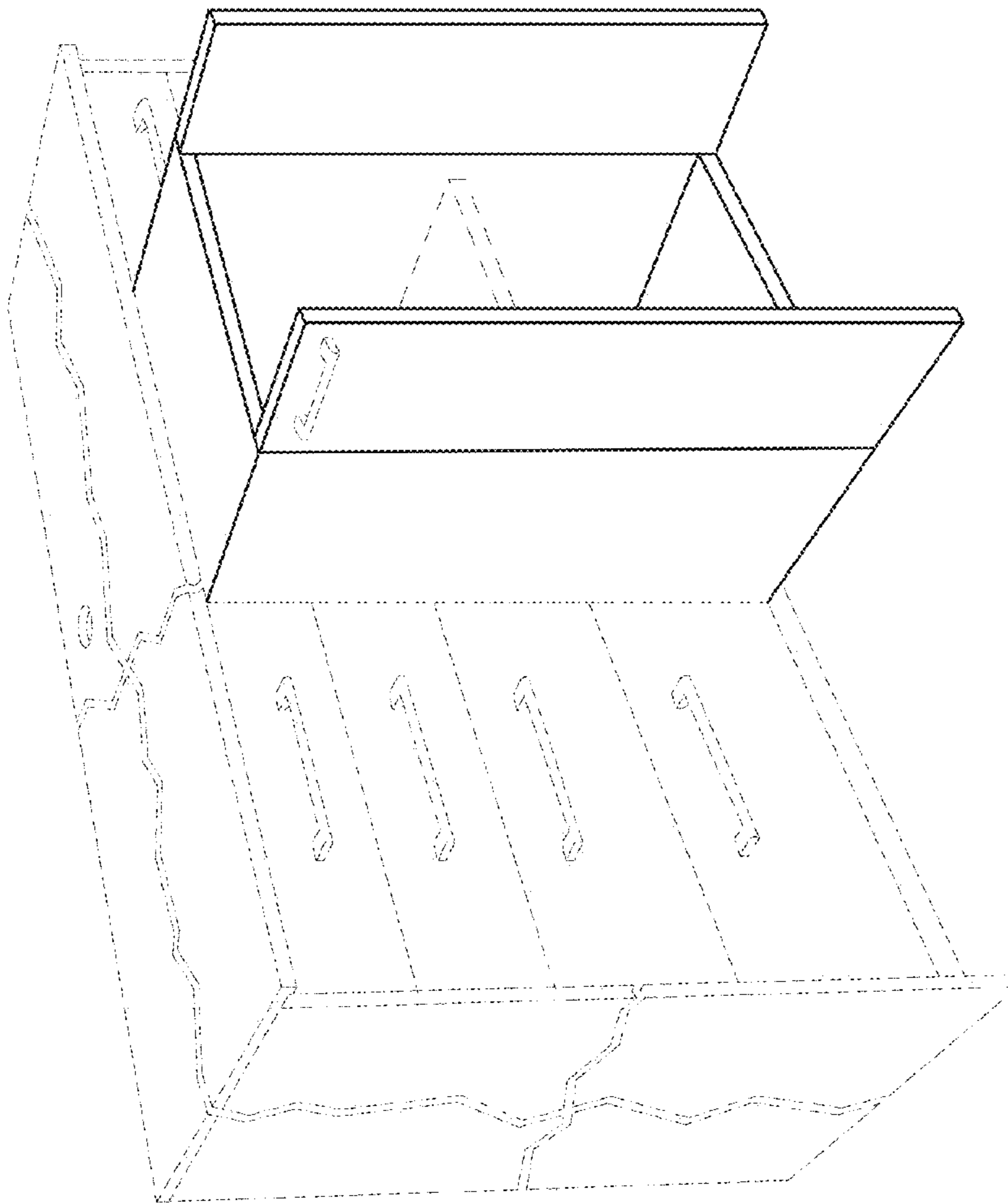

FIG. 37

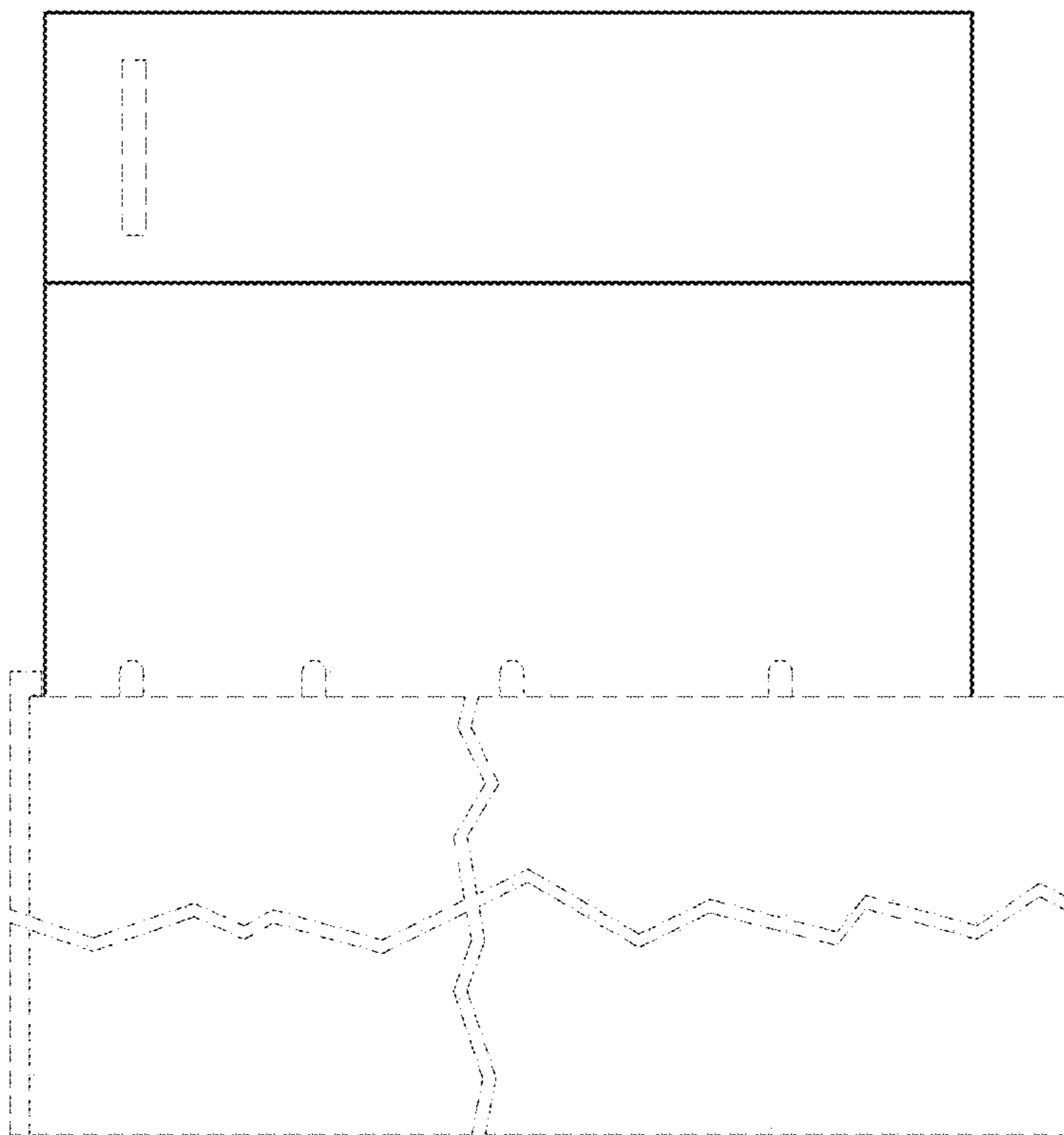

FIG. 38

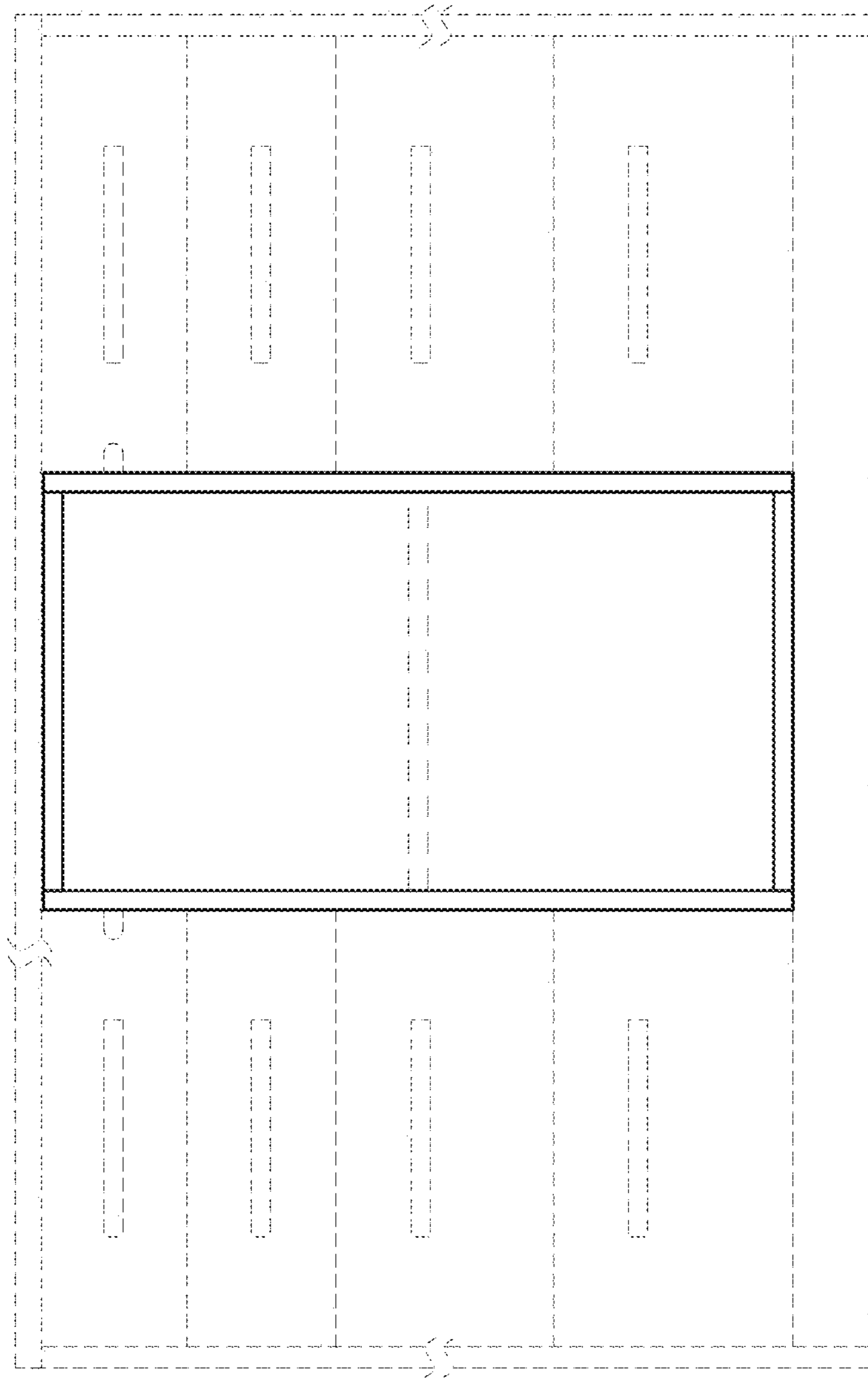

FIG. 39

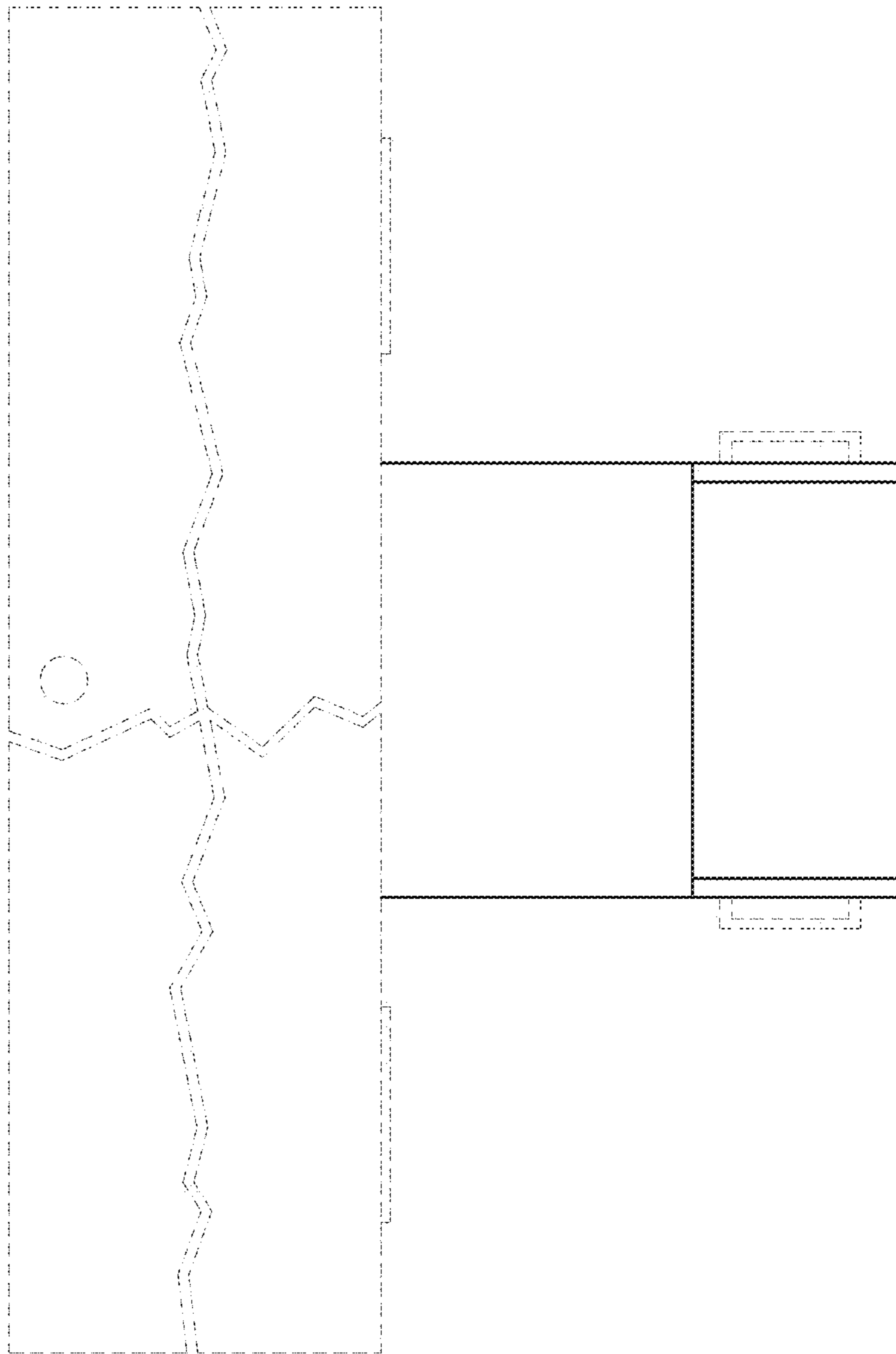

FIG. 40

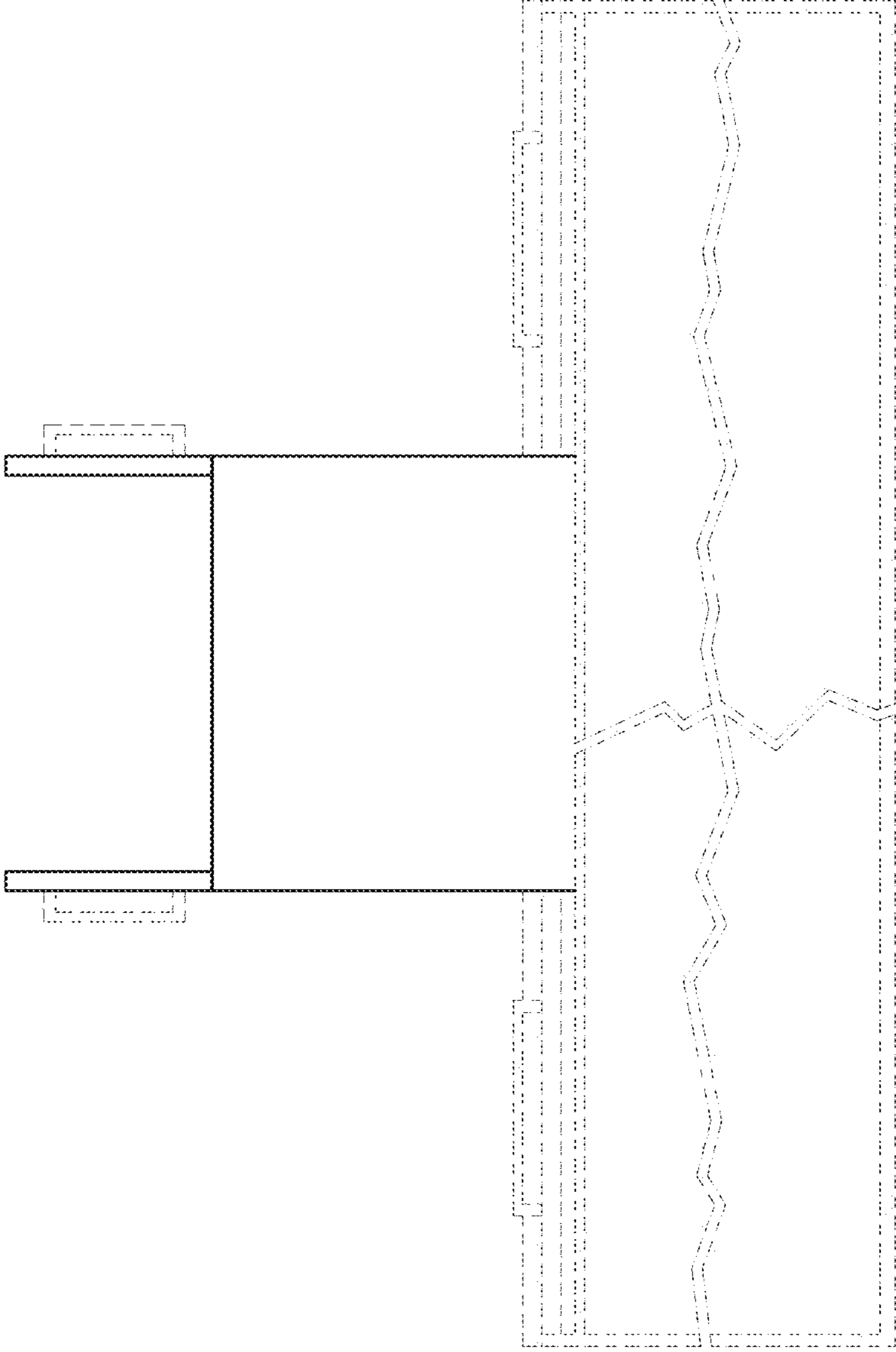

FIG. 41