



US00D740940S

(12) **United States Design Patent**
Fregoso et al.

(10) **Patent No.:** **US D740,940 S**

(45) **Date of Patent:** **** Oct. 13, 2015**

(54) **IRRIGATION TIP**

(71) Applicant: **American Eagle Instruments, Inc.**,
Missoula, MT (US)

(72) Inventors: **Gilbert Fregoso**, Missoula, MT (US);
Yuval Charles Avniel, Missoula, MT
(US)

(73) Assignee: **American Eagle Instruments, Inc.**,
Missoula, MT (US)

(**) Term: **14 Years**

(21) Appl. No.: **29/483,581**

(22) Filed: **Feb. 28, 2014**

(51) **LOC (10) Cl.** **24-02**

(52) **U.S. Cl.**
USPC **D24/152**

(58) **Field of Classification Search**
USPC D24/152, 155-156, 176, 127, 133, 147,
D24/146; D8/86; D15/132, 138-139;
433/172-174, 3, 50, 53, 82, 114, 141,
433/165-166; 606/80, 96, 98; 408/209, 225
See application file for complete search history.

(56) **References Cited**

U.S. PATENT DOCUMENTS

3,322,124 A * 5/1967 Ireland 433/141
5,037,300 A * 8/1991 Weissman 433/166

5,076,788 A * 12/1991 Niznick 433/173
5,195,892 A * 3/1993 Gersberg 433/174
5,261,818 A * 11/1993 Shaw 433/165
5,556,280 A * 9/1996 Pelak 433/172
D532,109 S * 11/2006 Carroll D24/152
8,113,833 B2 * 2/2012 Courvoisier 433/165

* cited by examiner

Primary Examiner — Wan Laymon

(74) *Attorney, Agent, or Firm* — Heslin Rothenberg Farley
& Mesiti, P.C.

(57) **CLAIM**

The ornamental design for an irrigation tip, as shown and
described.

DESCRIPTION

FIG. 1 is a front perspective view of the irrigation tip com-
prising the new design;
FIG. 2 is a right elevational view of the design of FIG. 1,
where the left elevational view, is a mirror image;
FIG. 3 is a top view of the design of FIG. 1;
FIG. 4 is a bottom view of the design of FIG. 1;
FIG. 5 is a front elevational view of the design of FIG. 1;
FIG. 6 is a back elevational view of the design of FIG. 1; and,
FIG. 7 is another perspective view of the irrigation tip design
of FIG. 1.

The broken away symbols in the drawings indicate that any
portion of the article beyond what is shown forms no part of
the claimed design.

The broken lines shown in the figures represent portions of
the irrigation tip that form no part of the claimed design.

1 Claim, 3 Drawing Sheets

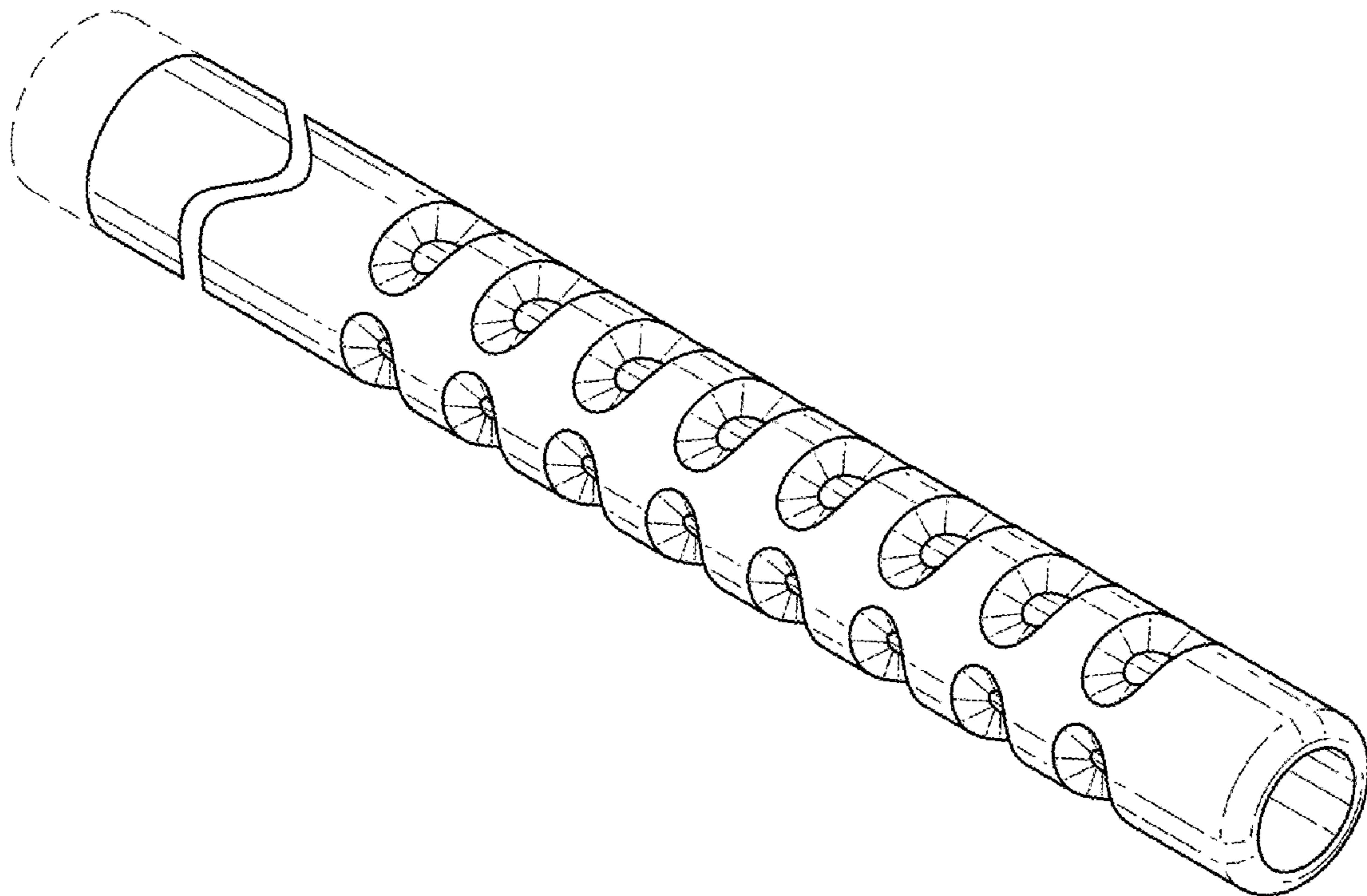

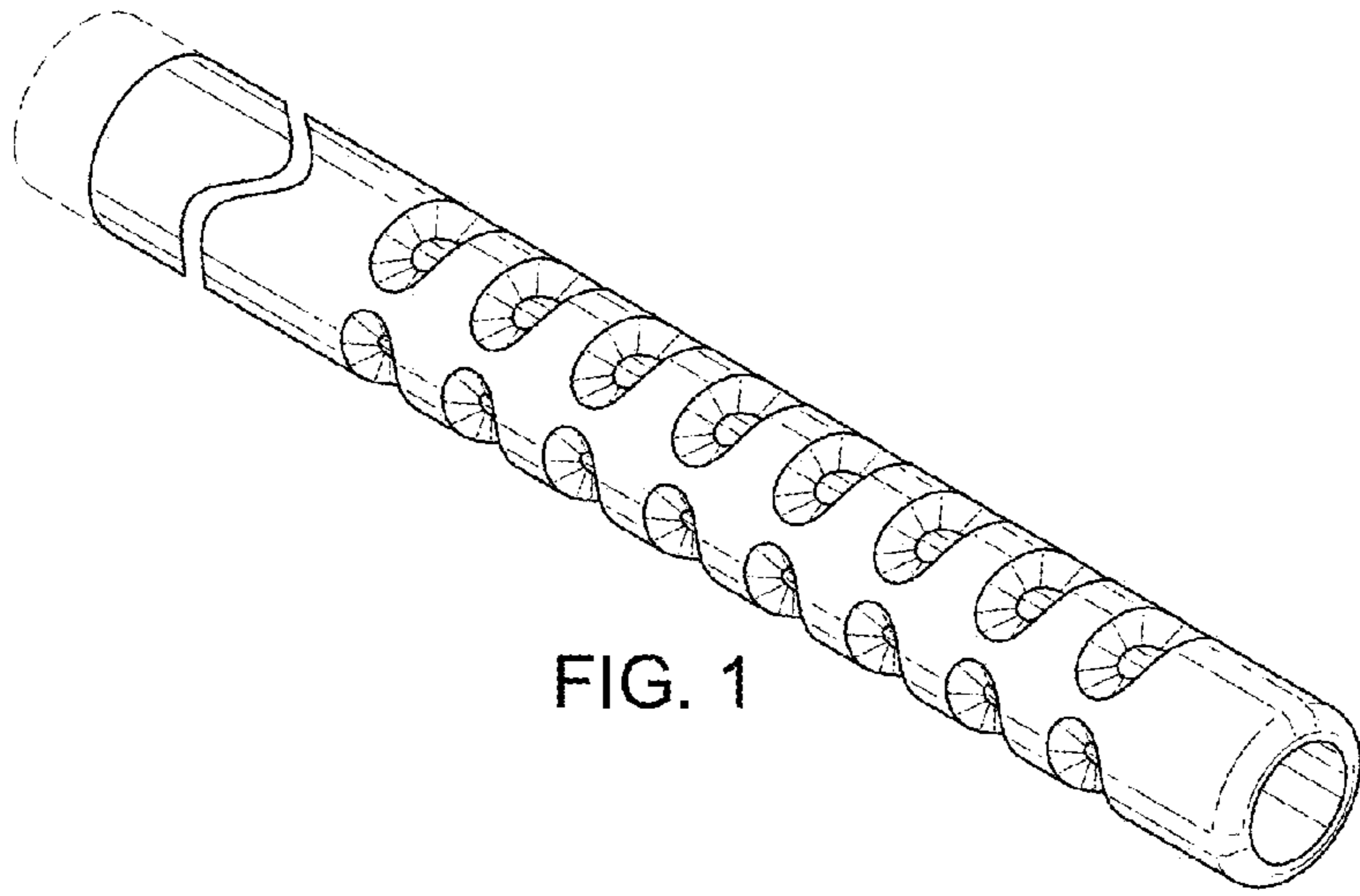

FIG. 1

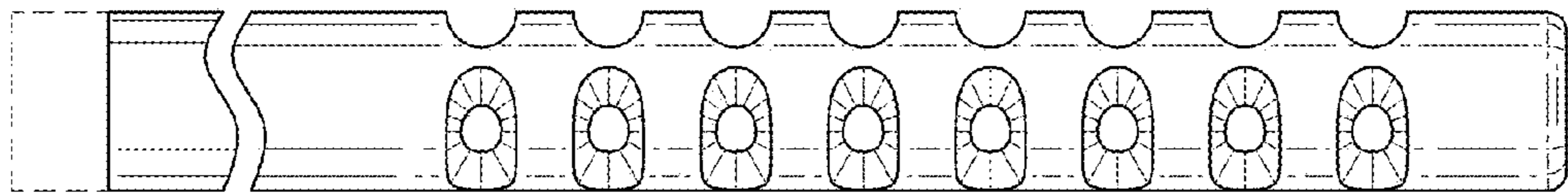

FIG. 2

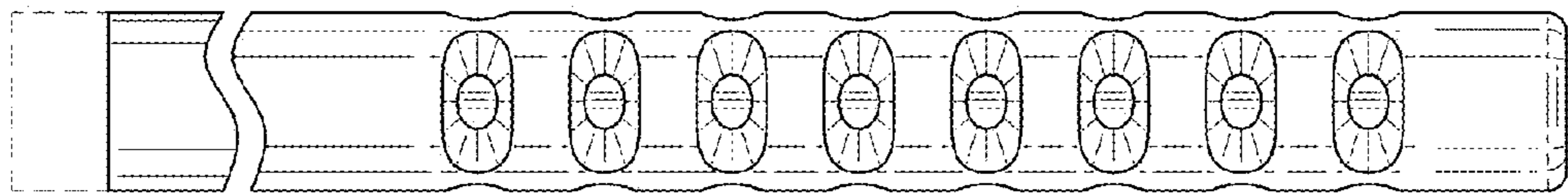

FIG. 3

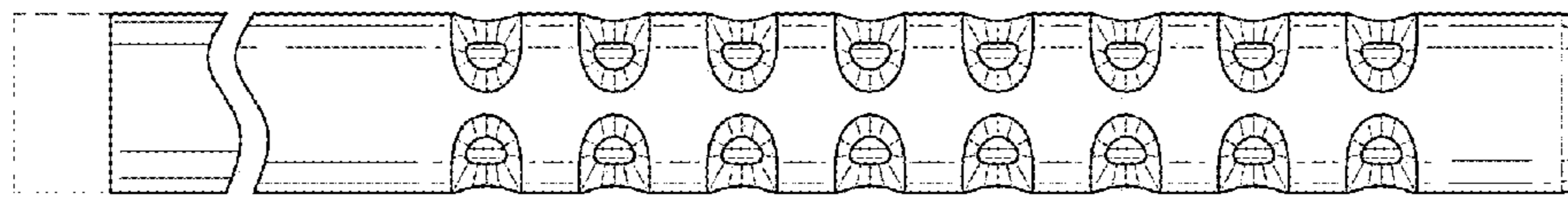

FIG. 4

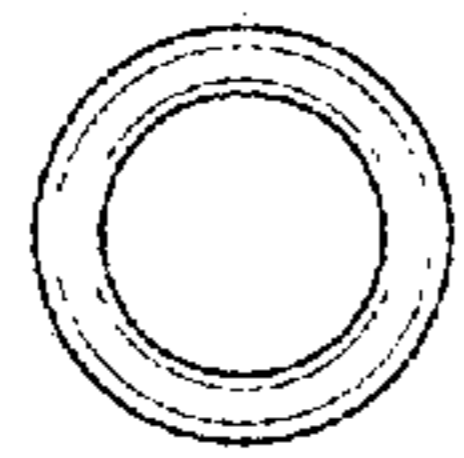

FIG. 5

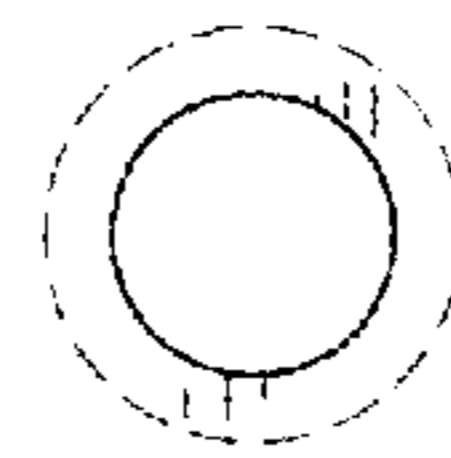

FIG. 6

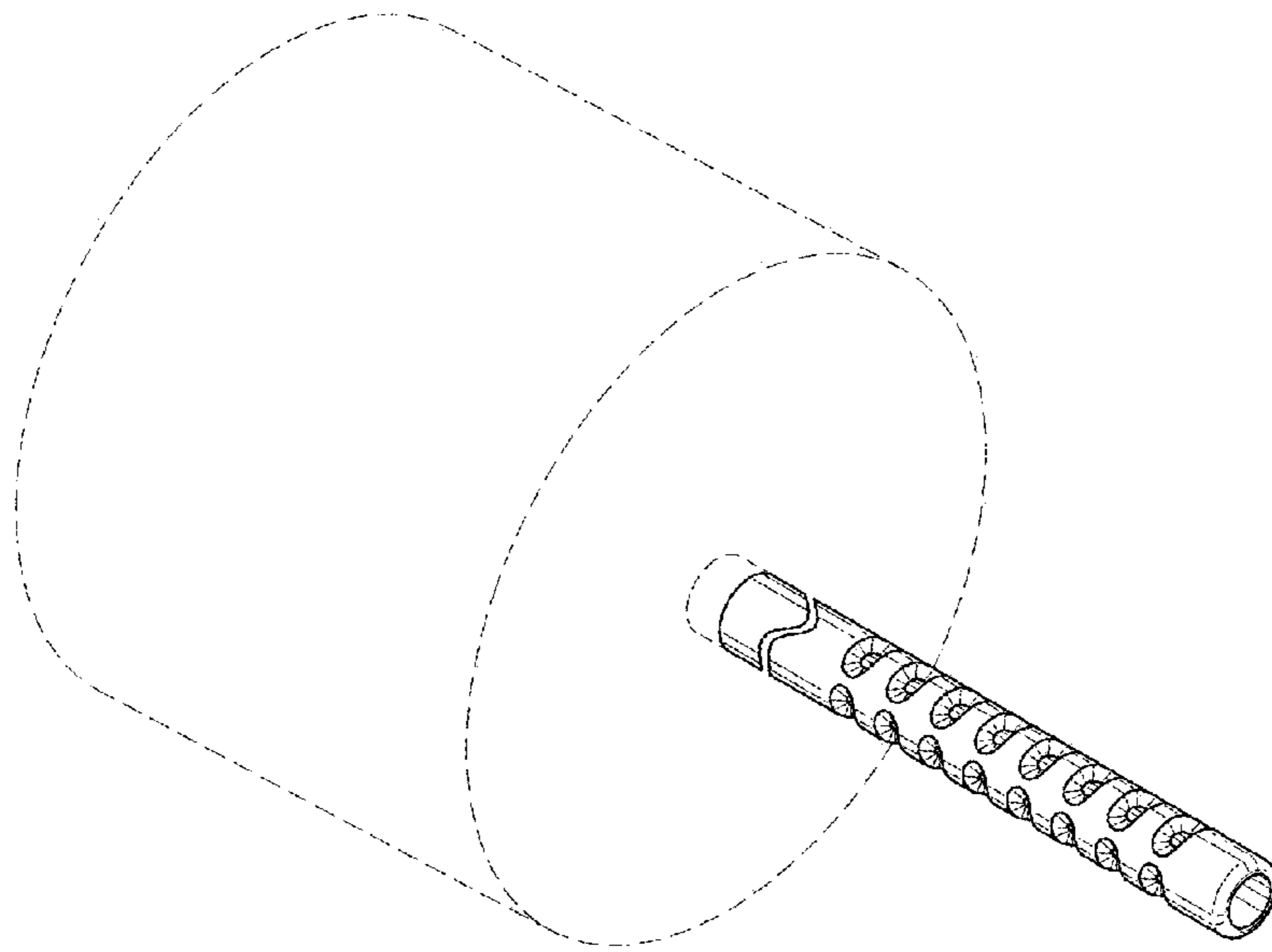

FIG. 7