



US00D740903S

(12) **United States Design Patent**
Siciliano

(10) **Patent No.:** **US D740,903 S**

(45) **Date of Patent:** **** Oct. 13, 2015**

(54) **TRAINING BAG COVER WITH FIGHTER AND BUCKLE**

(71) Applicant: **Brett Siciliano**, Irvine, CA (US)

(72) Inventor: **Brett Siciliano**, Irvine, CA (US)

(**) Term: **14 Years**

(21) Appl. No.: **29/510,538**

(22) Filed: **Dec. 1, 2014**

(51) **LOC (10) Cl.** **21-02**

(52) **U.S. Cl.**
USPC **D21/798**; D21/787

(58) **Field of Classification Search**
USPC D6/661.2; D21/662, 327, 787; D25/16, D25/32; 482/9, 87, 83, 86, 3, 902, 8, 84, 482/901, 88, 90, 35, 38, 41, 89; 434/247; 473/451, 422, 445, 441; 273/445, 408; 73/12.04, 379.04

See application file for complete search history.

(56) **References Cited**

U.S. PATENT DOCUMENTS

4,088,315	A *	5/1978	Schemmel	482/4
4,974,833	A *	12/1990	Hartman et al.	482/3
5,110,124	A *	5/1992	Micco	473/441
5,281,191	A *	1/1994	DeSousa	482/83
D384,378	S *	9/1997	Sigler	D21/787
D410,986	S *	6/1999	Luedke et al.	D21/798
6,110,079	A *	8/2000	Luedke et al.	482/83
6,258,013	B1 *	7/2001	Dabney	482/83
7,909,749	B2 *	3/2011	Sheedy	482/148
9,021,857	B1 *	5/2015	Squire et al.	73/12.04
2010/0130333	A1 *	5/2010	Strong et al.	482/83

* cited by examiner

Primary Examiner — Robert M Spear

Assistant Examiner — Ryan Harvey

(74) *Attorney, Agent, or Firm* — Grant's Law Firm; Allan Howard Grant

(57) **CLAIM**

I claim the ornamental design for a training bag cover with fighter and buckle, as shown and as described.

DESCRIPTION

FIG. 1 is a perspective view of the front of the training bag cover with fighter and buckle.

FIG. 2 is the front view of the training bag cover with fighter and buckle.

FIG. 3 is a back view of the training bag cover with fighter and buckle.

FIG. 4 is a side view of the training bag cover with fighter and buckle.

FIG. 5 is the other side view of the training bag cover with fighter and buckle.

FIG. 6 is a top view of the training bag cover with fighter and buckle.

FIG. 7 is the bottom view of the training bag cover with fighter and buckle.

FIG. 8 is a perspective front view of the training bag cover with fighter and buckle, shown attached to a punching bag.

FIG. 9 is a perspective back view of the training bag cover with fighter and buckle, shown attached to a punching bag.

FIG. 10 is a back perspective view of the training bag cover with fighter and buckle with straps and buckle in an alternate position.

FIG. 11 is a perspective view of the training bag cover with fighter and buckle shown rolled-up with carrying straps in broken lines; and,

FIG. 12 is a perspective view of the training bag cover with fighter and buckle shown rolled-up with carrying straps and user in broken lines.

In FIGS. 8 and 9 the training bag and chains are shown in broken lines to represent unclaimed subject matter only and do not form part of the claimed design.

In FIGS. 1-10, 11, and 12 carrying straps are shown in broken lines to represent unclaimed subject matter only and do not form part of the claimed design.

In FIG. 12 a user is shown in broken lines to represent unclaimed subject matter only and do not form part of the claimed design.

1 Claim, 8 Drawing Sheets

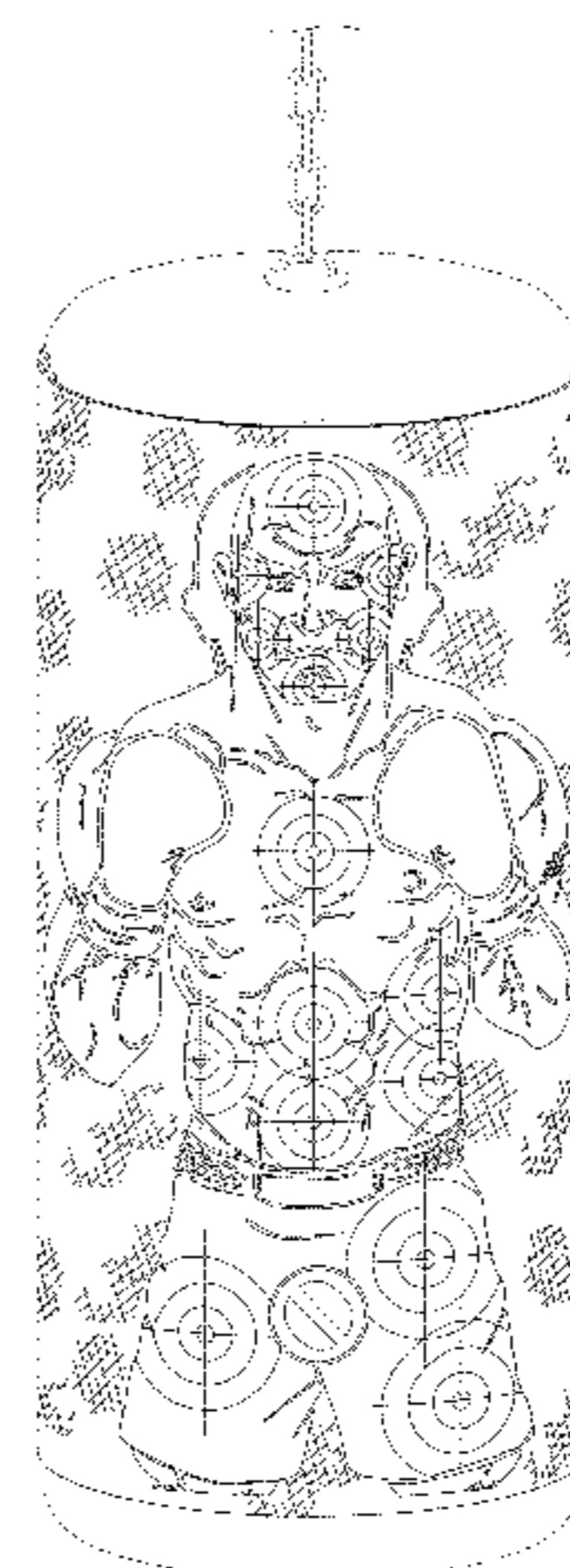
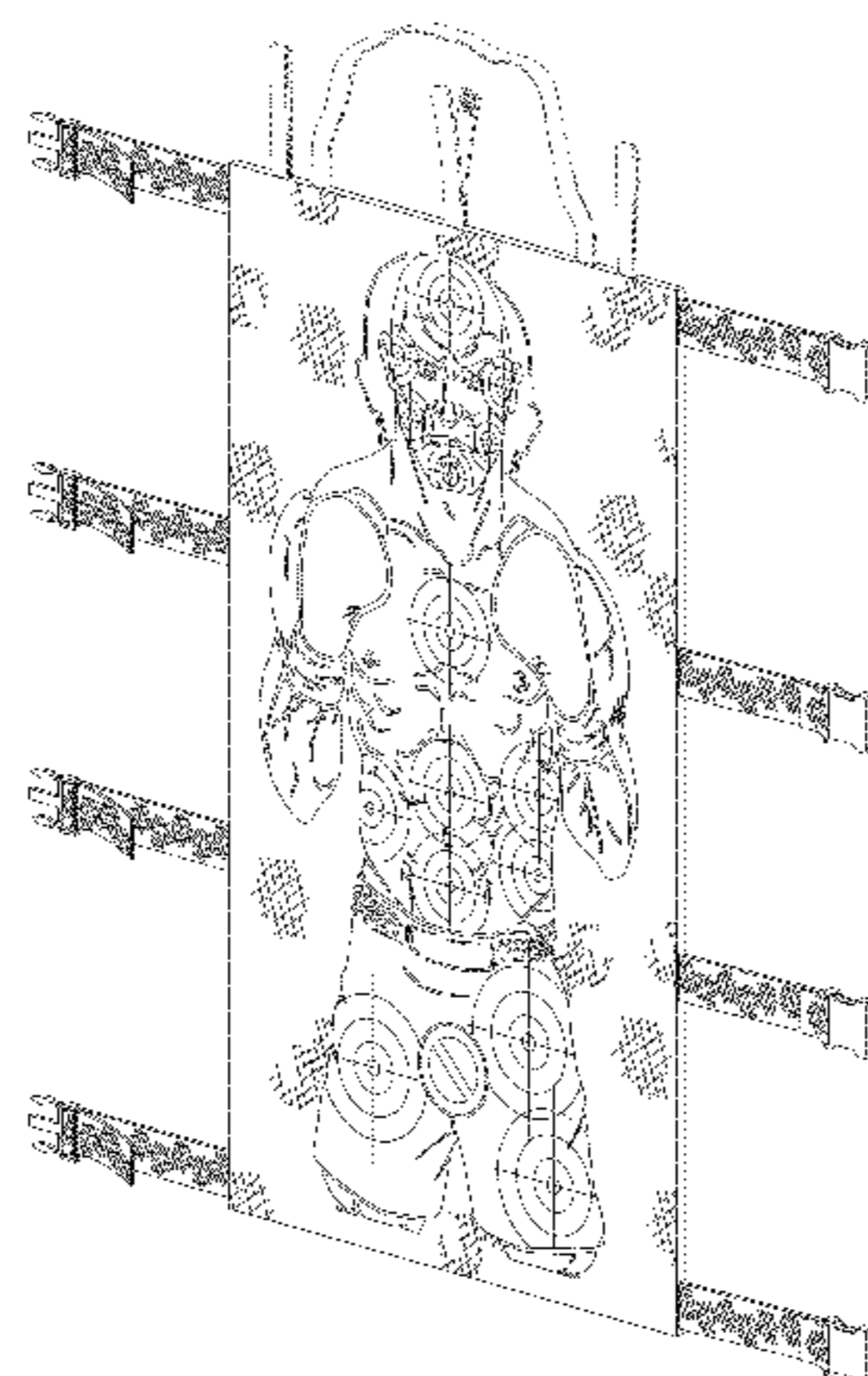

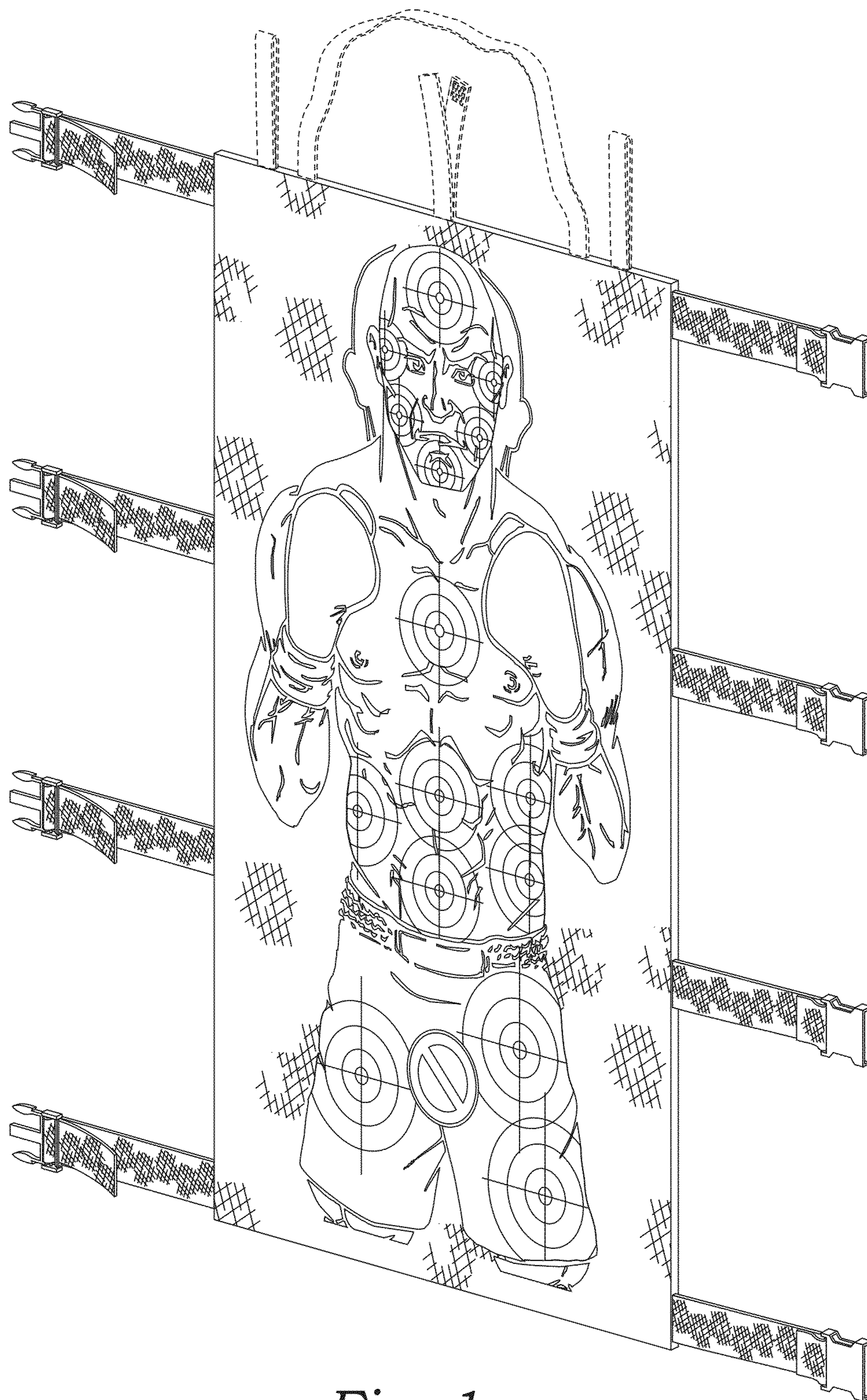

Fig. 1

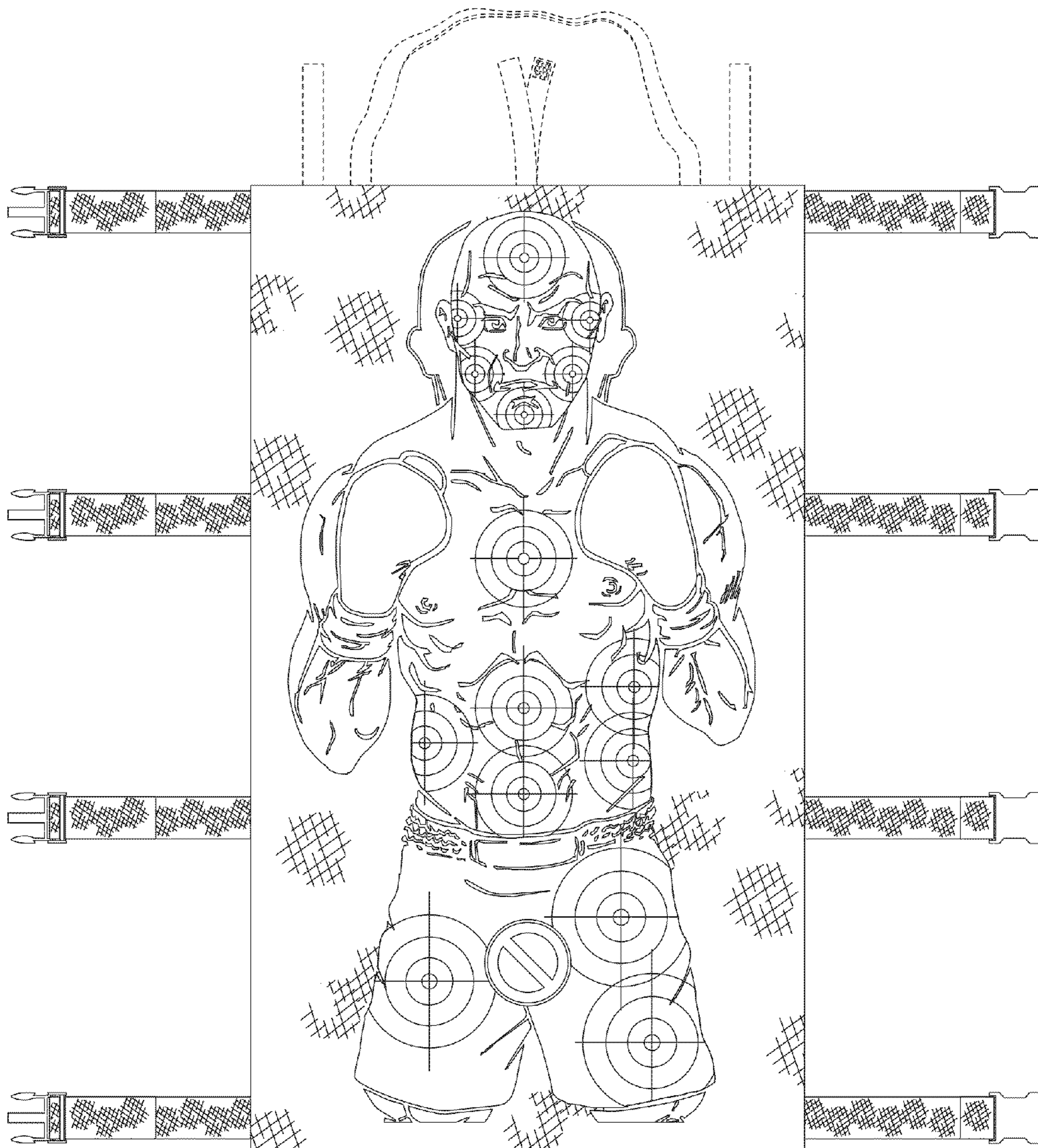

Fig. 2

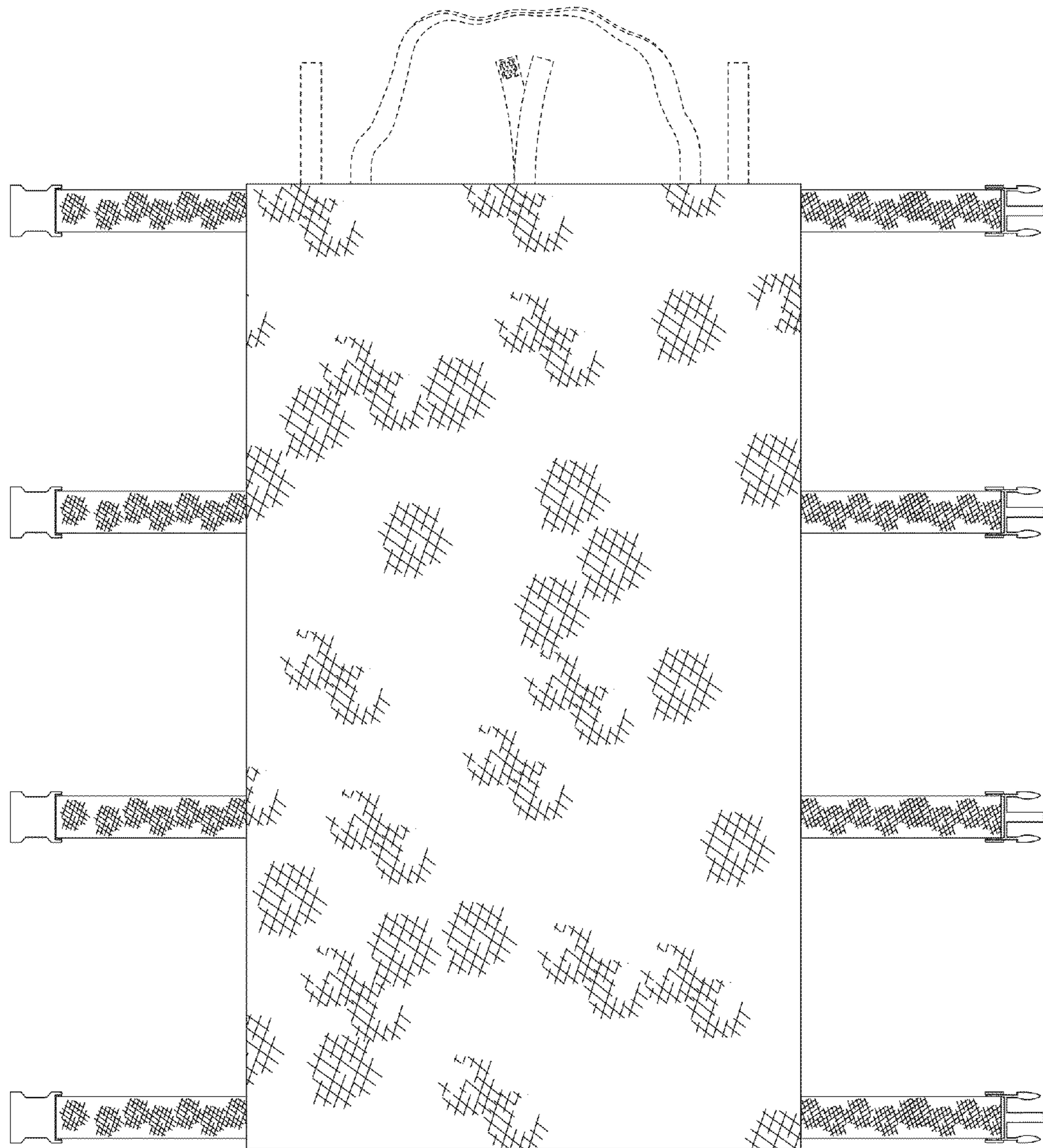
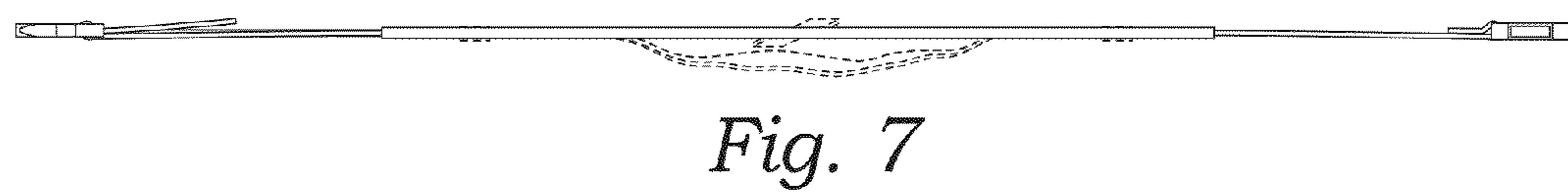
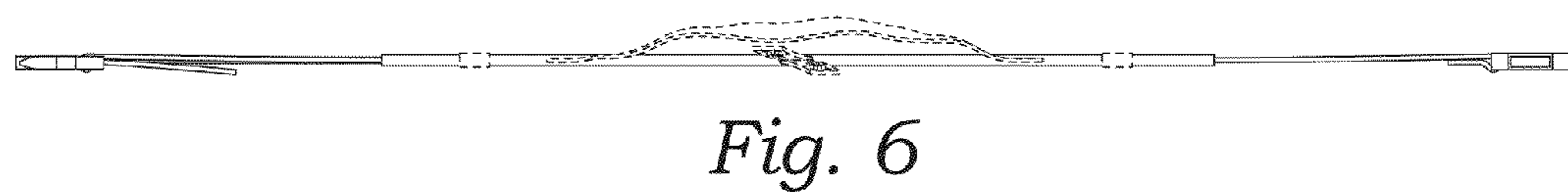
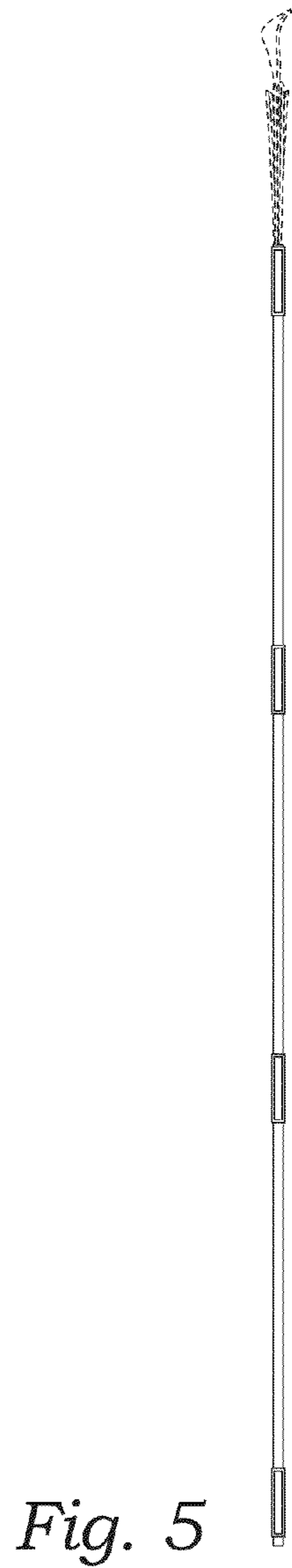
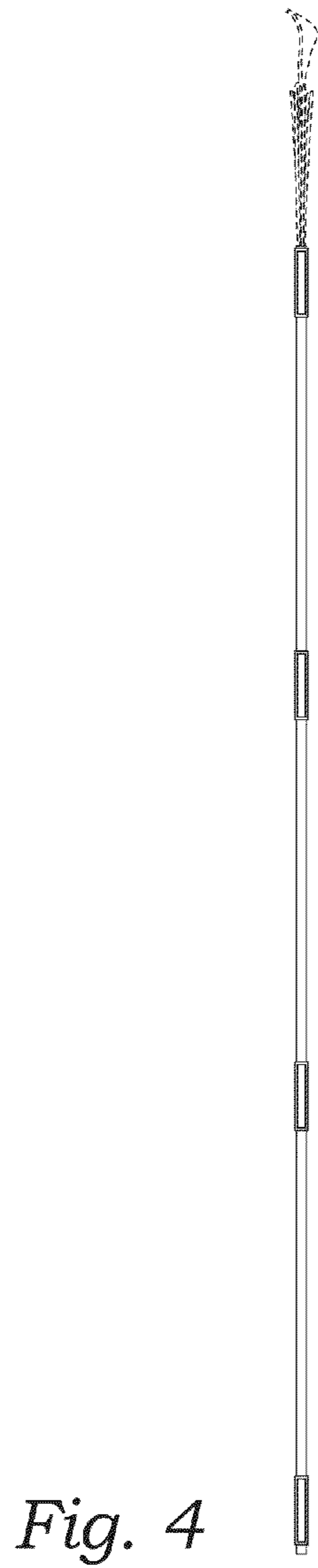

Fig. 3



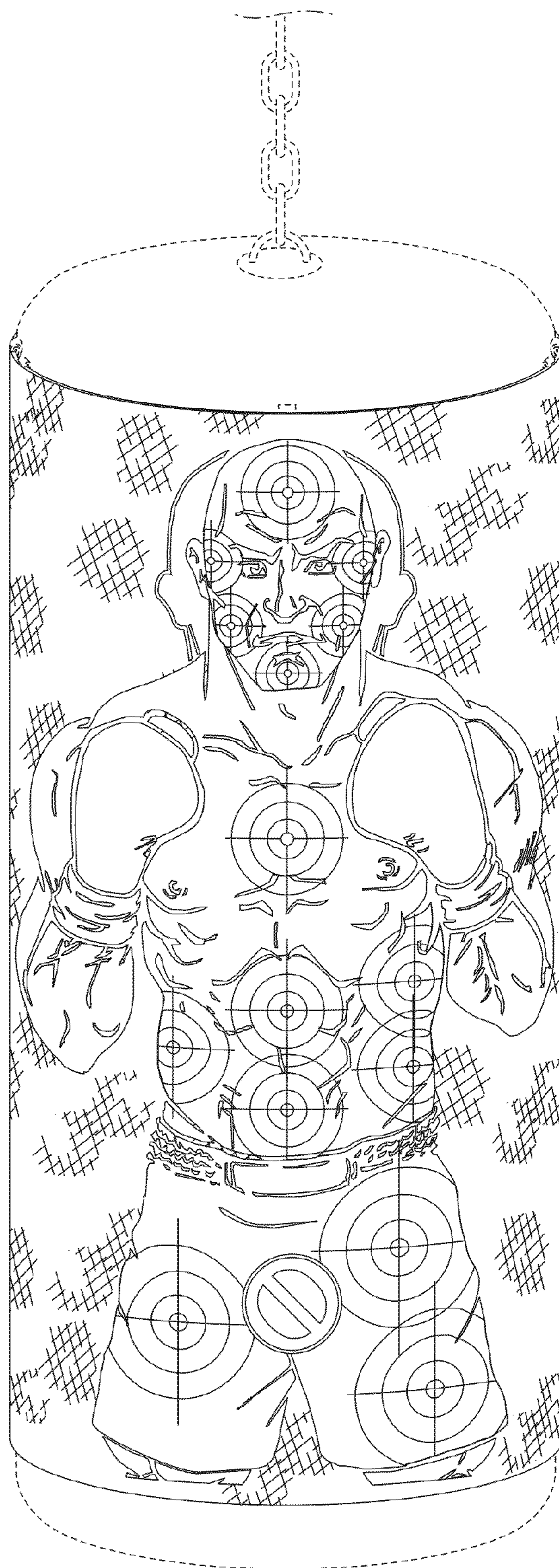

Fig. 8

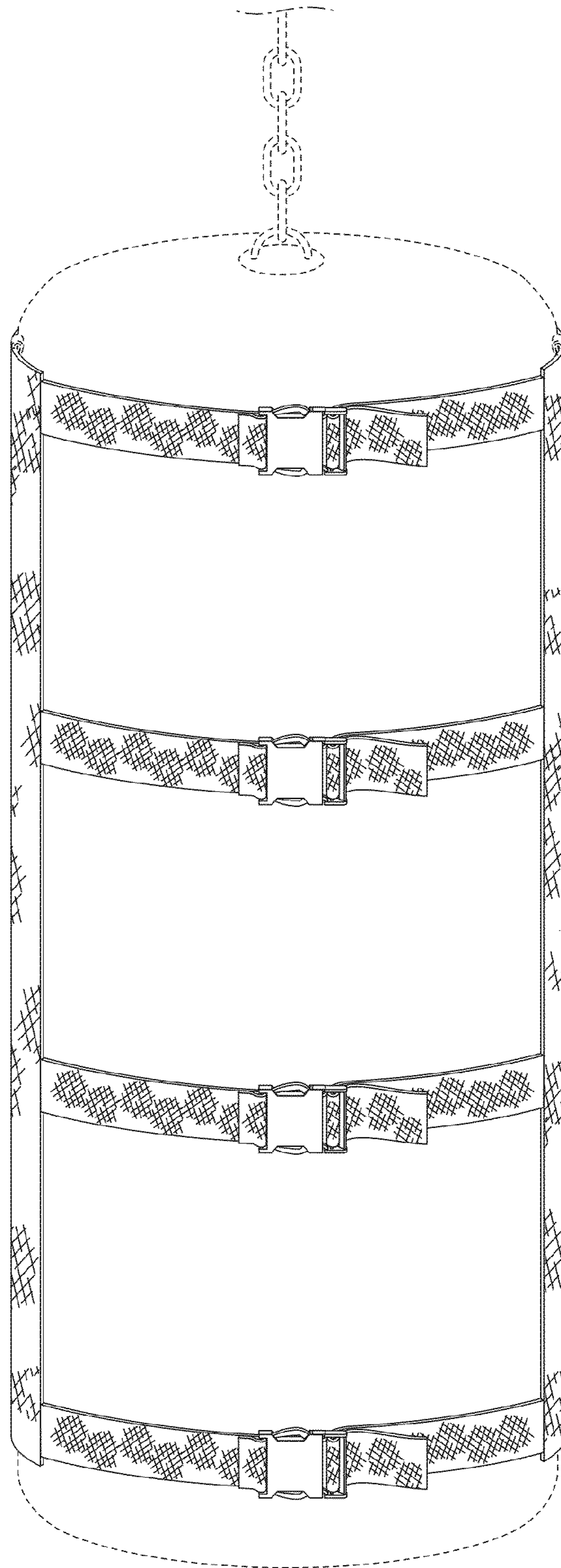

Fig. 9

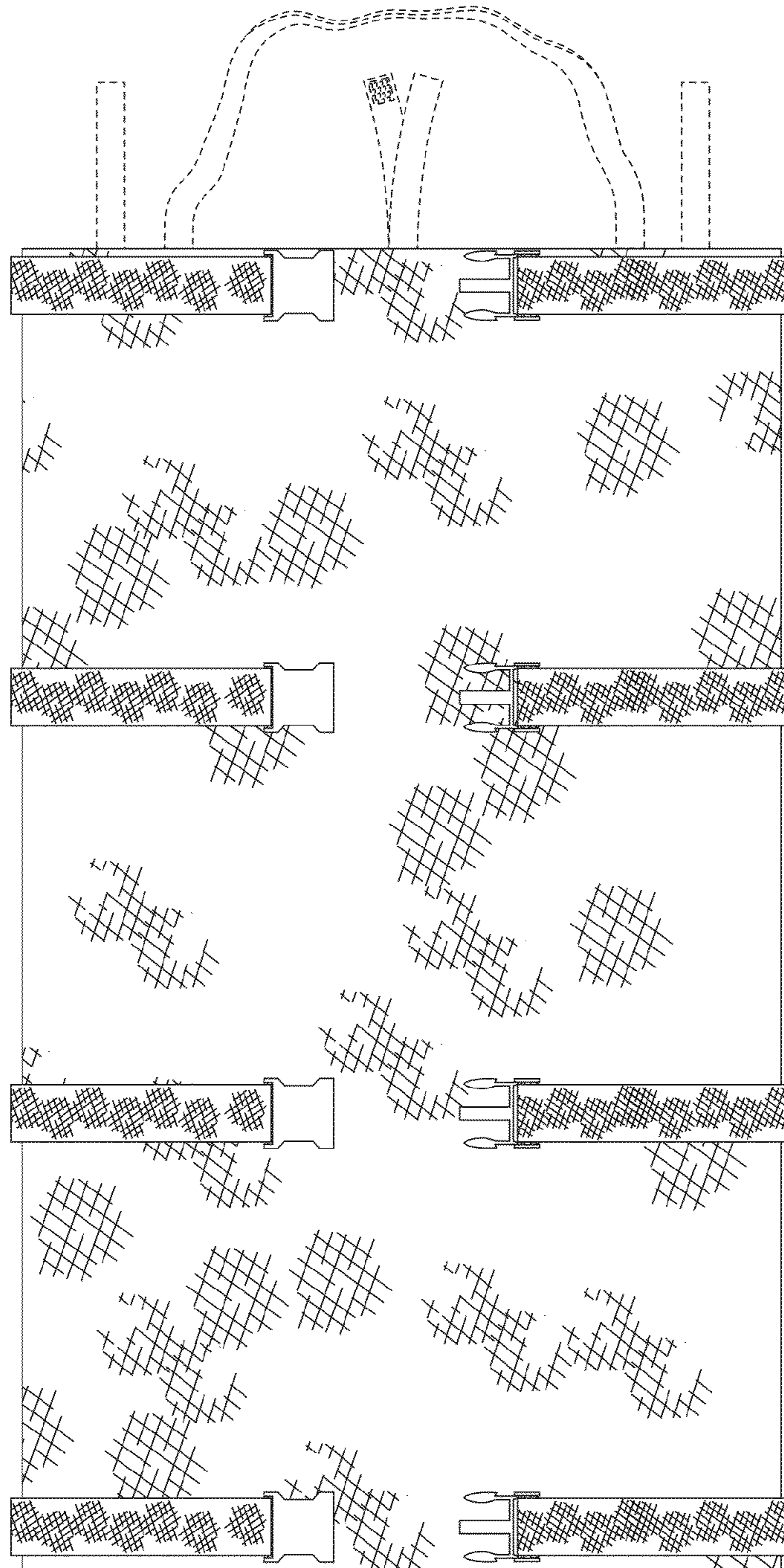

Fig. 10

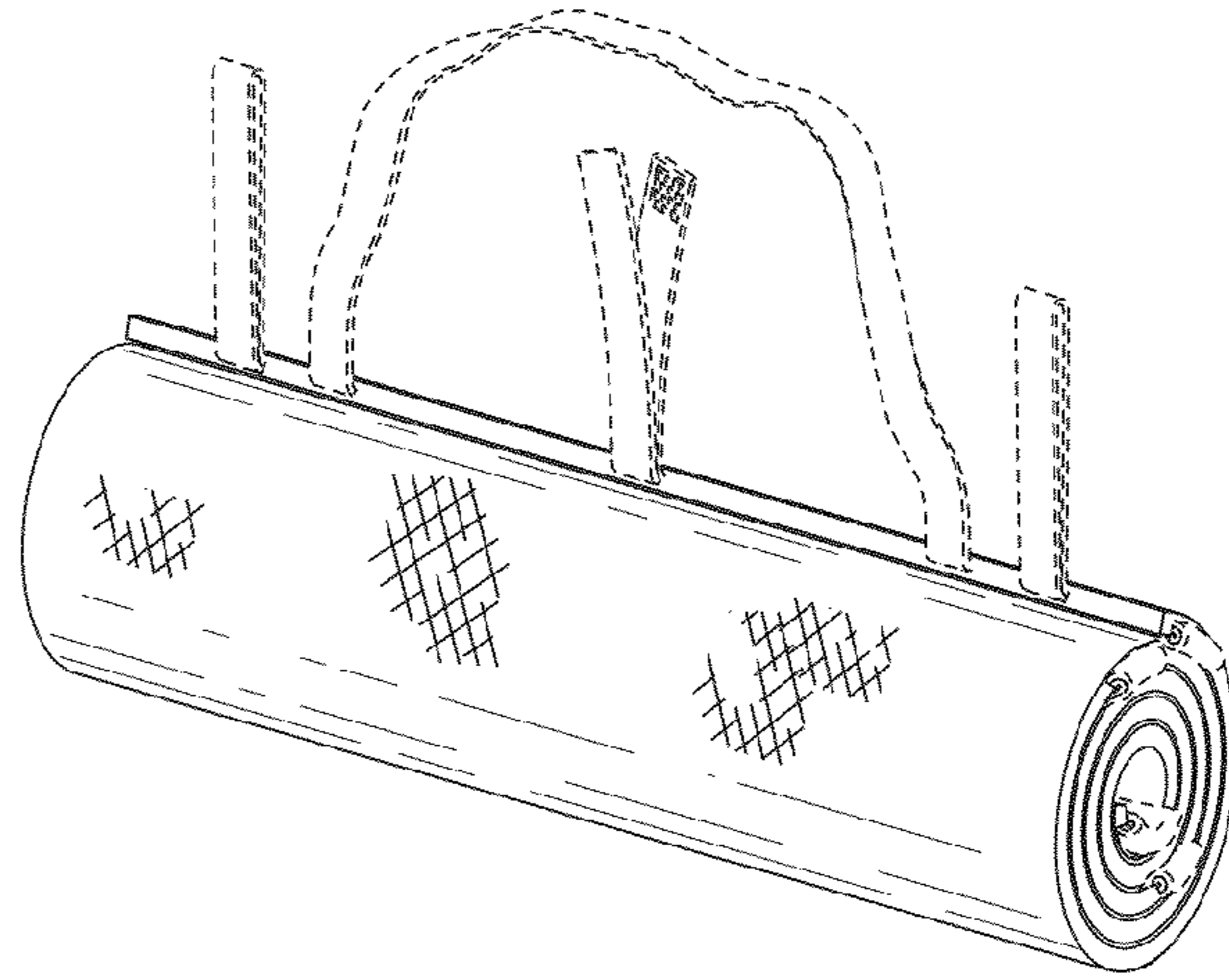

Fig. 11

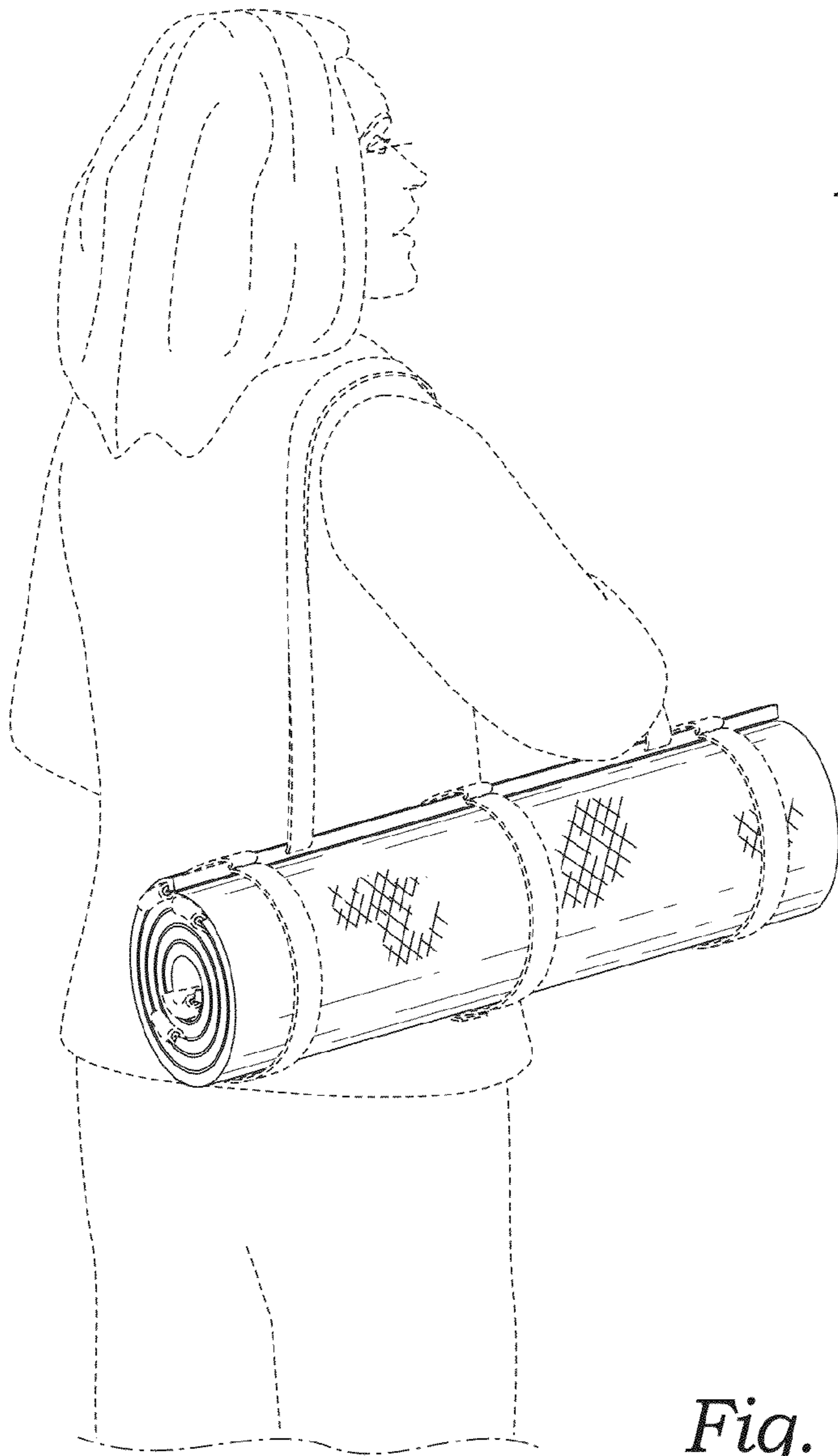

Fig. 12