



US00D740722S

(12) **United States Design Patent**
Bennett et al.

(10) **Patent No.:** **US D740,722 S**
(45) **Date of Patent:** **** Oct. 13, 2015**

- (54) **STROLLER HOOK**
- (71) Applicants: **Eric Bennett**, Foster City, CA (US);
Patrick Nolan, Royersford, PA (US);
Mike Dotsey, Pottstown, PA (US)
- (72) Inventors: **Eric Bennett**, Foster City, CA (US);
Patrick Nolan, Royersford, PA (US);
Mike Dotsey, Pottstown, PA (US)
- (73) Assignee: **HELEN OF TROY LIMITED**, St.
Michael (BB)
- (**) Term: **14 Years**
- (21) Appl. No.: **29/459,725**
- (22) Filed: **Jul. 2, 2013**
- (51) **LOC (10) Cl.** **12-12**
- (52) **U.S. Cl.**
USPC **D12/133**
- (58) **Field of Classification Search**
USPC D12/128-133; D8/307, 315, 356;
248/214; 16/422, 436; 294/142, 143
See application file for complete search history.

D259,238	S *	5/1981	Schenck, III	D8/307
6,711,784	B2 *	3/2004	Walker	16/436
6,901,635	B1 *	6/2005	Scola	16/422
D598,732	S *	8/2009	Bizzell	D8/356
RE42,568	E *	7/2011	Artemi	248/214
8,002,225	B1 *	8/2011	Malone	248/214
D669,763	S *	10/2012	Abels	D8/356
8,695,179	B2 *	4/2014	Dunn et al.	24/599.1
2012/0042486	A1 *	2/2012	Dunn et al.	24/599.1

* cited by examiner

Primary Examiner — Susan Bennett Hattan
Assistant Examiner — Charles Hanson

(57) **CLAIM**

The ornamental design for a stroller hook, as shown, and described.

DESCRIPTION

FIG. 1 is a front view of the stroller hook;
FIG. 2 is a rear view of the stroller hook;
FIG. 3 is a left side view of the stroller hook;
FIG. 4 is a right side view of the stroller hook;
FIG. 5 is a bottom view of the stroller hook;
FIG. 6 is a top view of the stroller hook;
FIG. 7 is a perspective view of the stroller hook; and,
FIG. 8 is a perspective view of the stroller hook affixed to a stroller.
The broken lines are for illustrative purposes only and form no part of the claimed design.

1 Claim, 8 Drawing Sheets

- (56) **References Cited**
U.S. PATENT DOCUMENTS
3,633,801 A * 1/1972 Bonasso 294/142
4,153,189 A * 5/1979 Hughes 294/143
D256,405 S * 8/1980 Wheeler D3/315

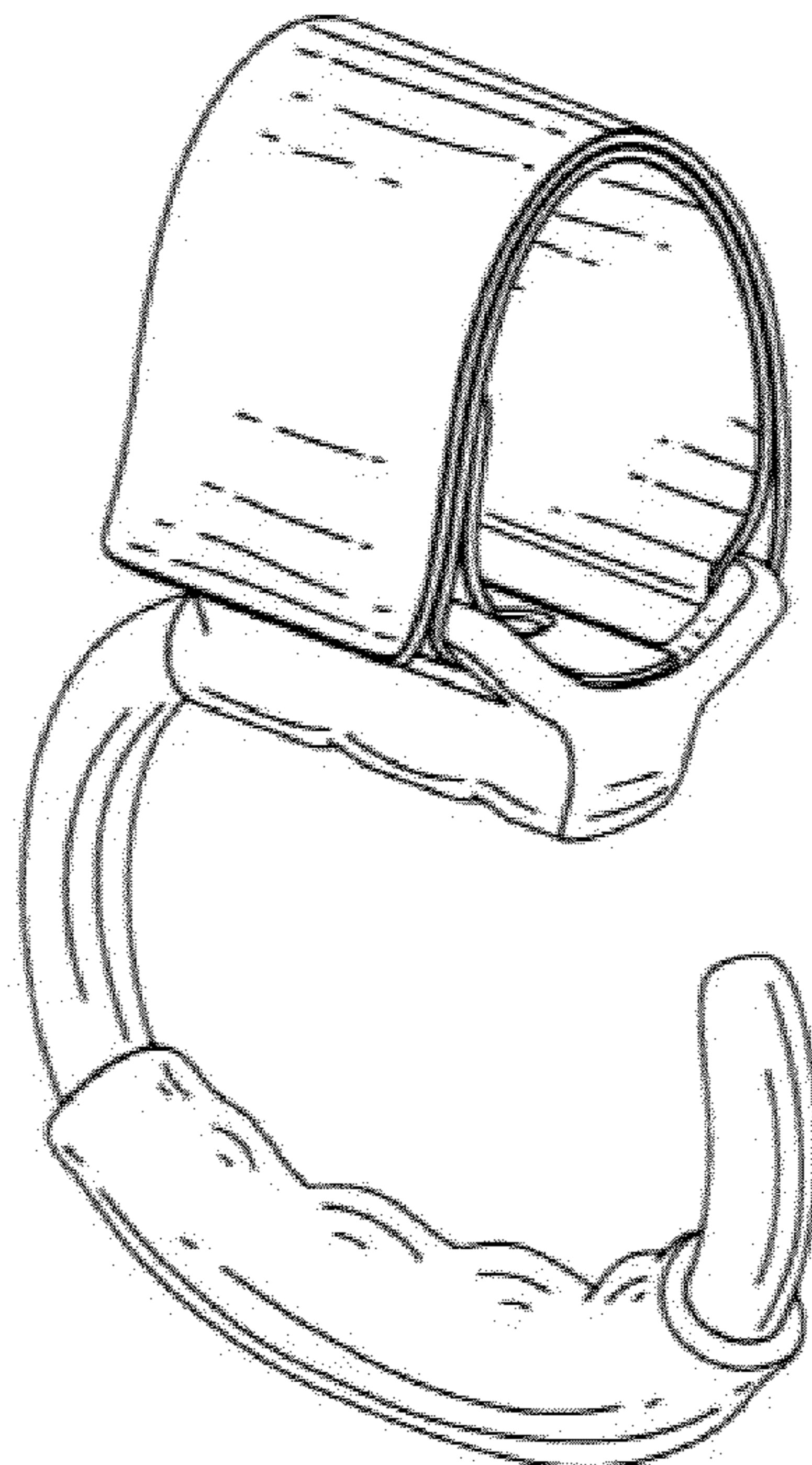

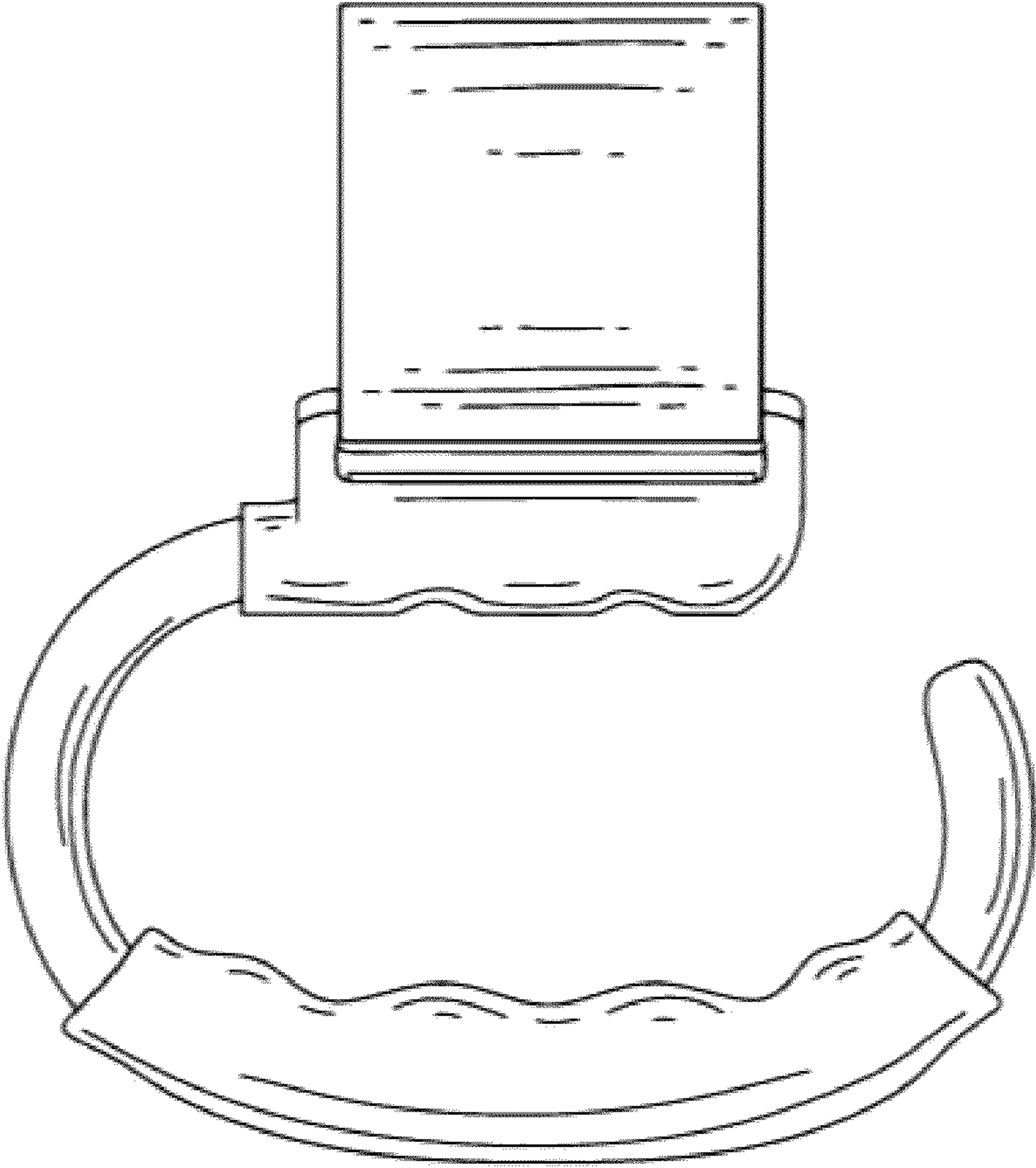

Figure 1

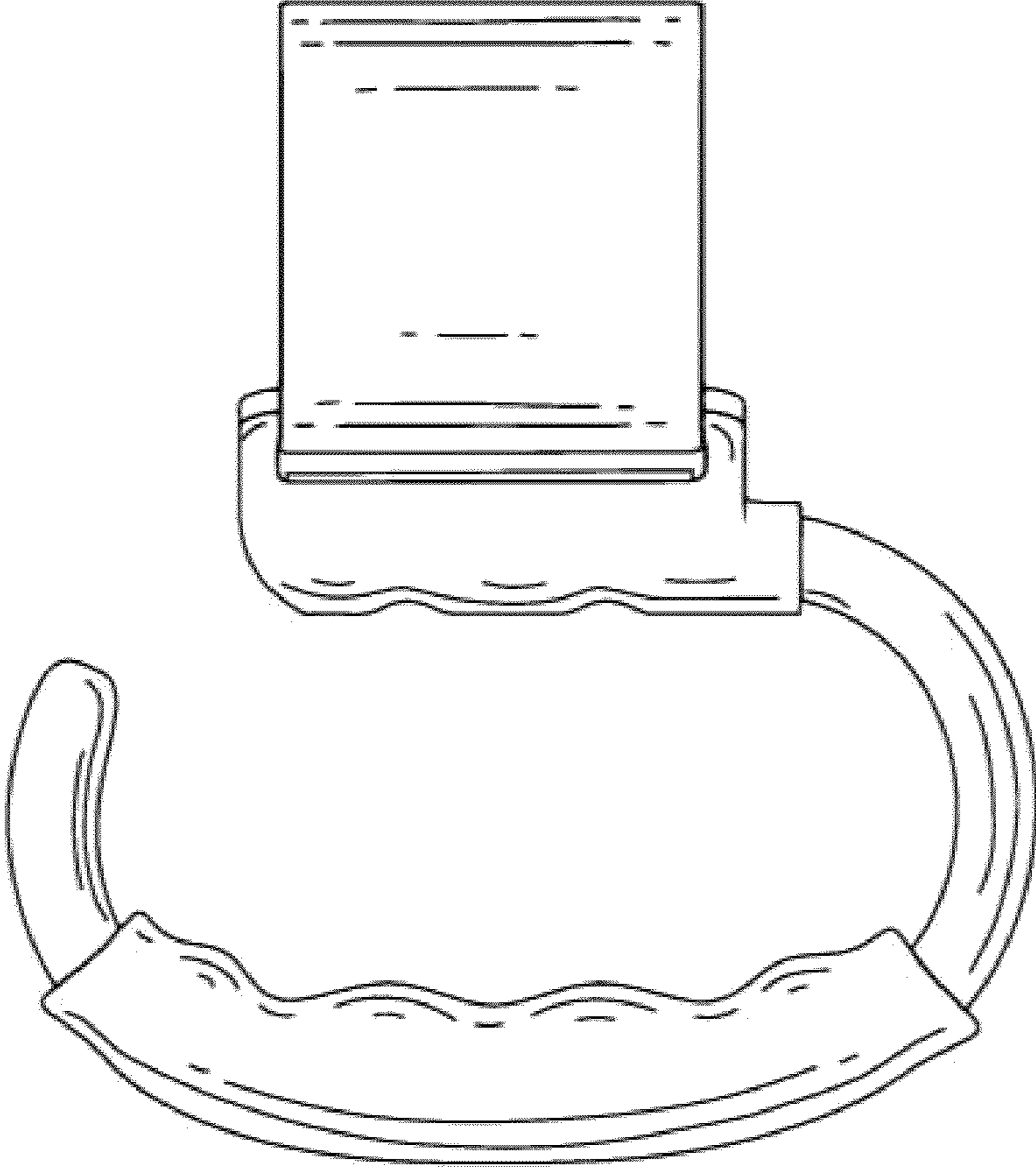

Figure 2

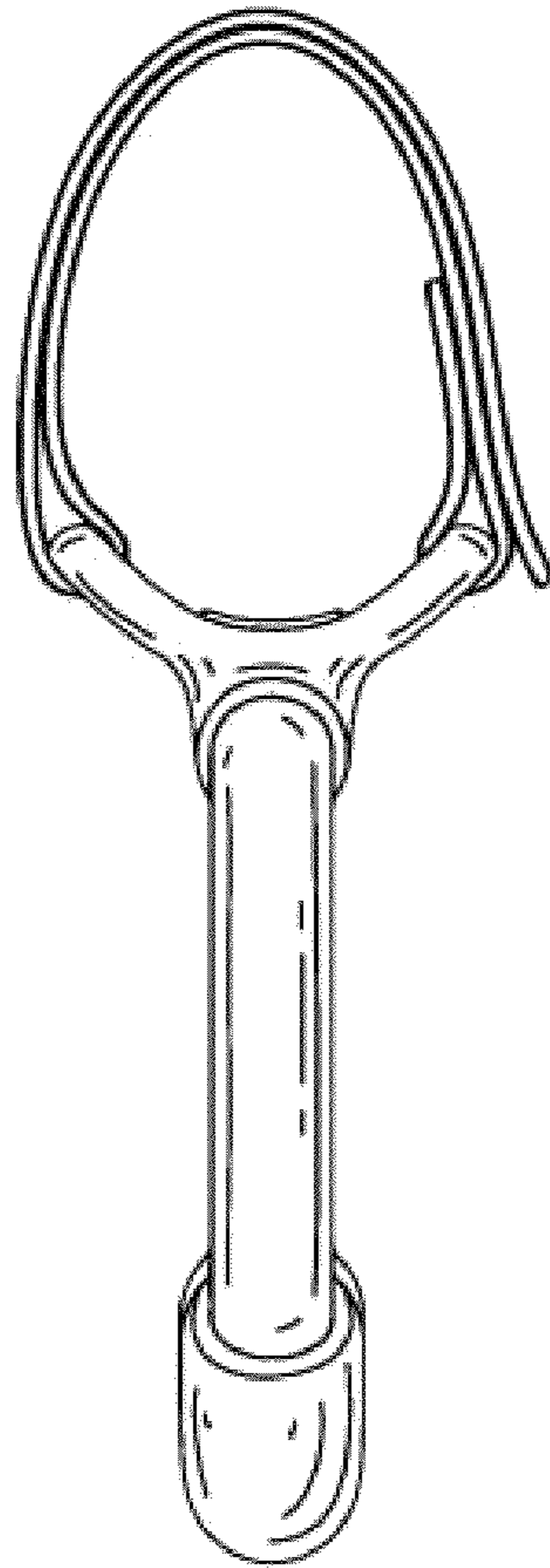

Figure 3

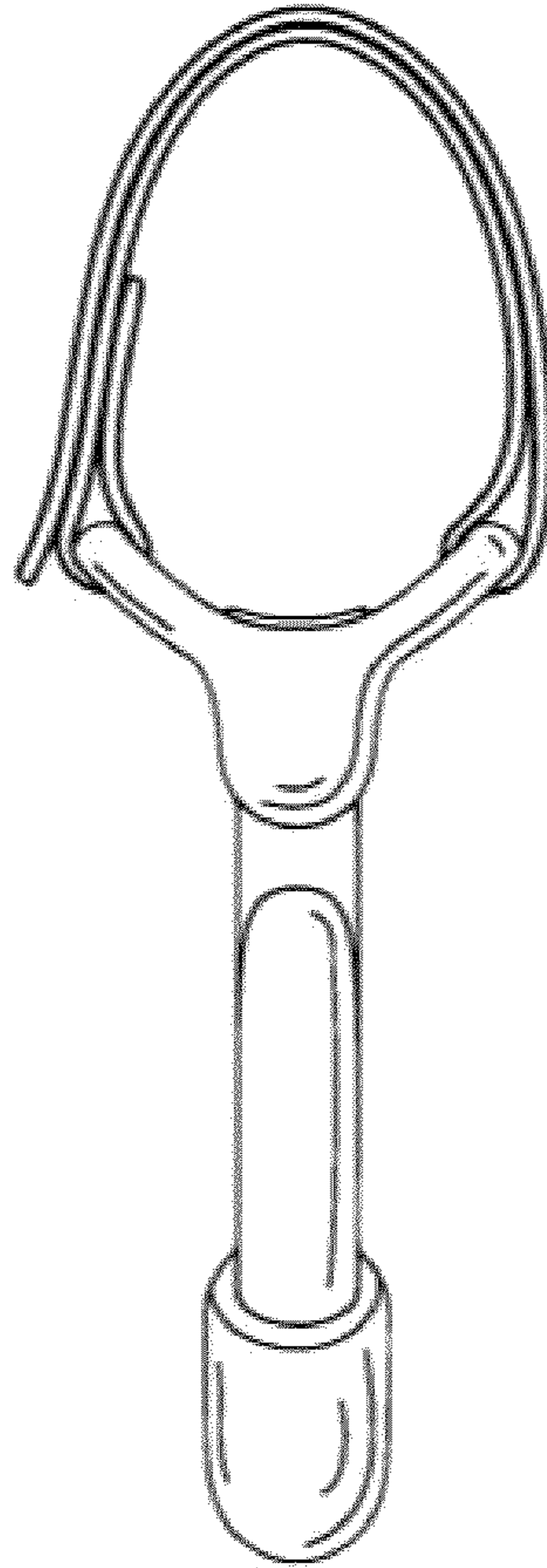

Figure 4

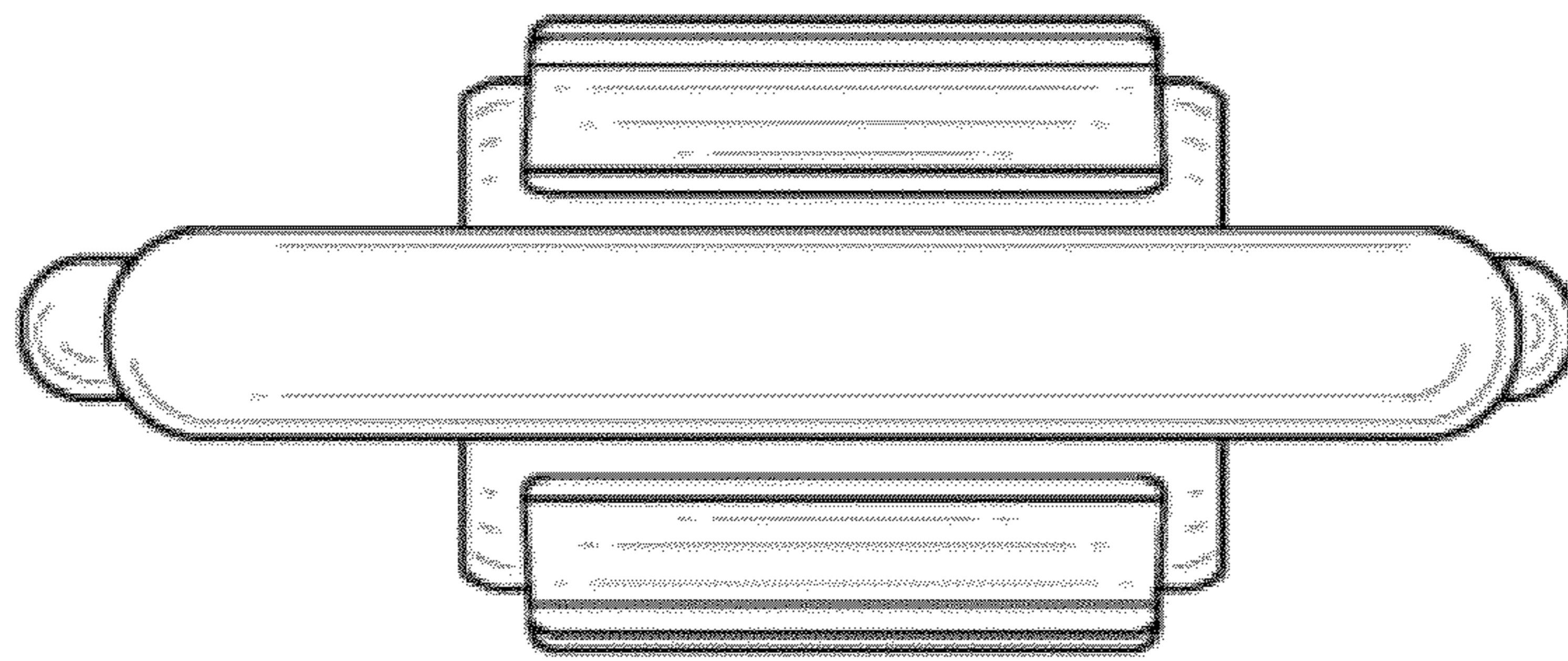

Figure 5

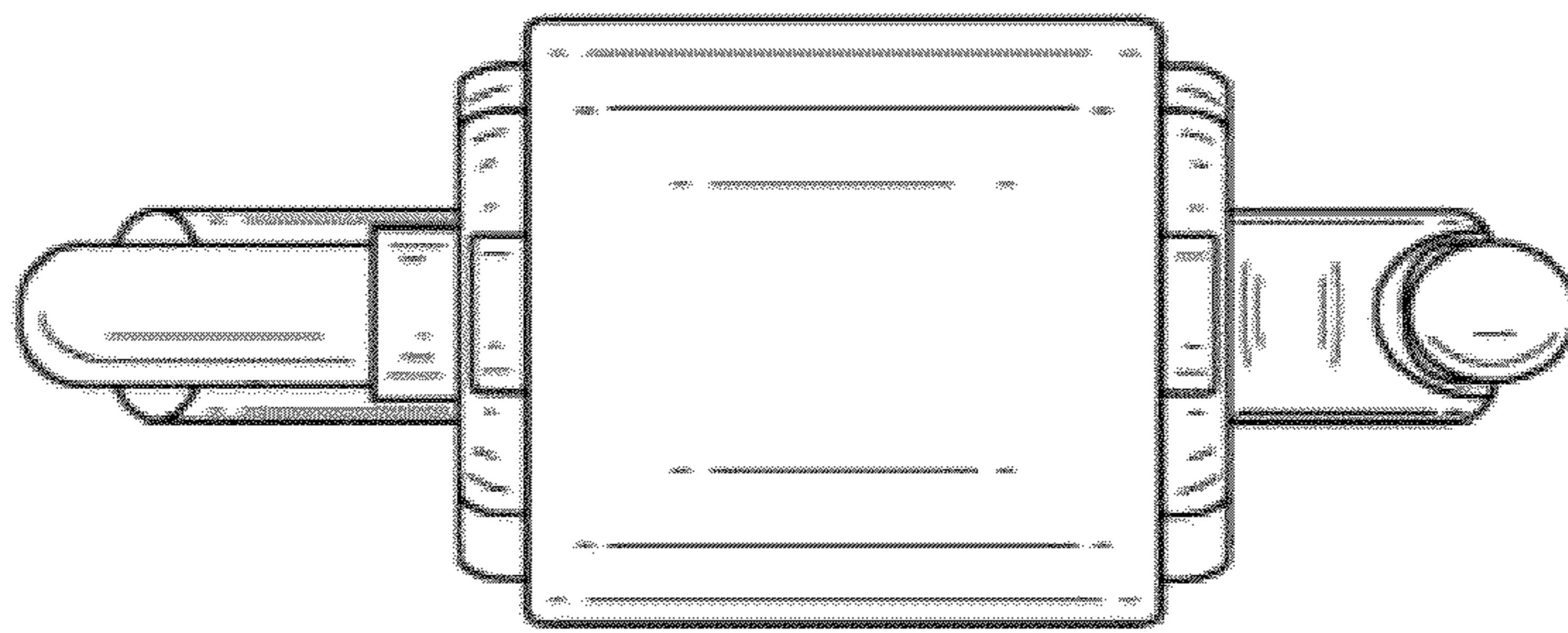

Figure 6

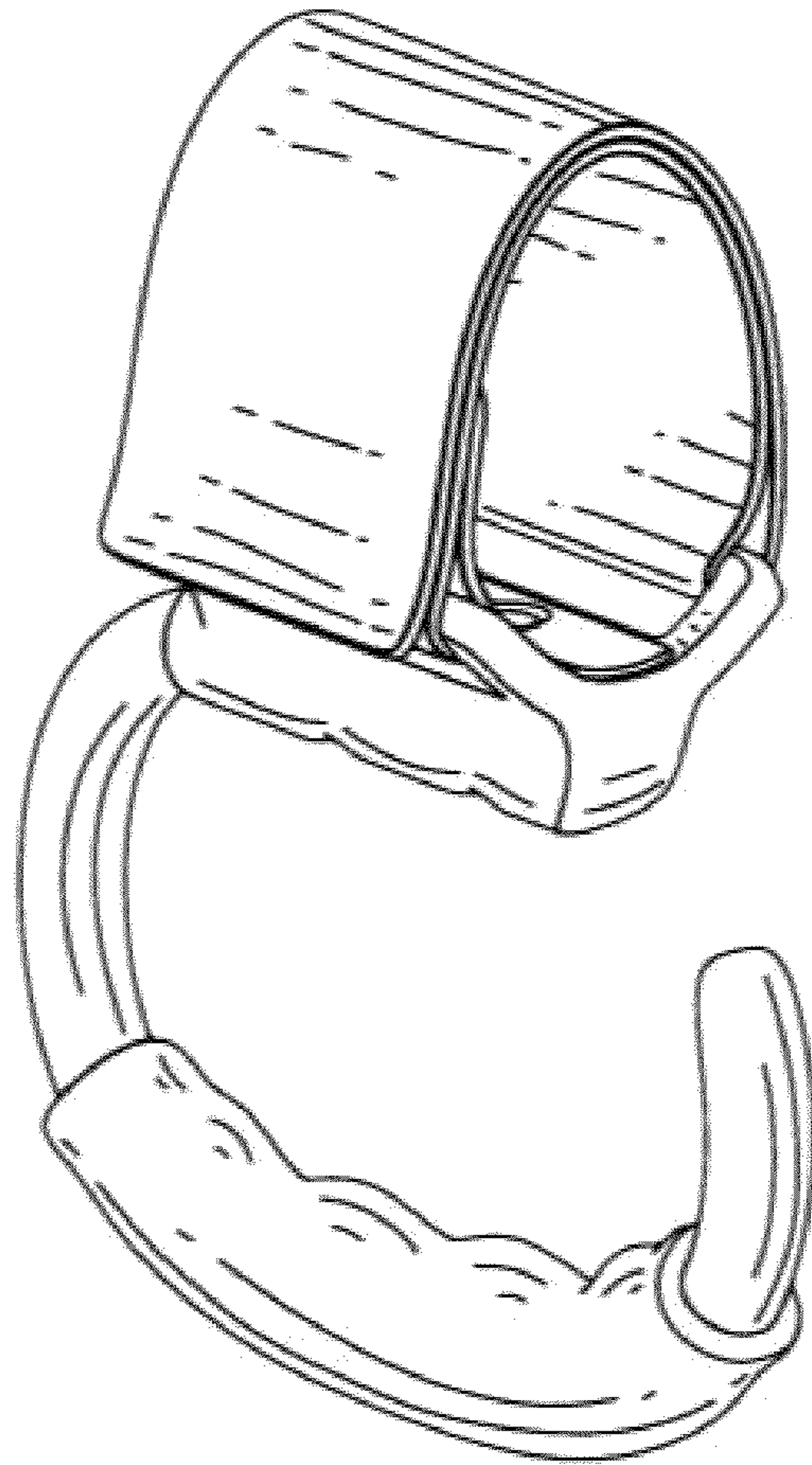

Figure 7

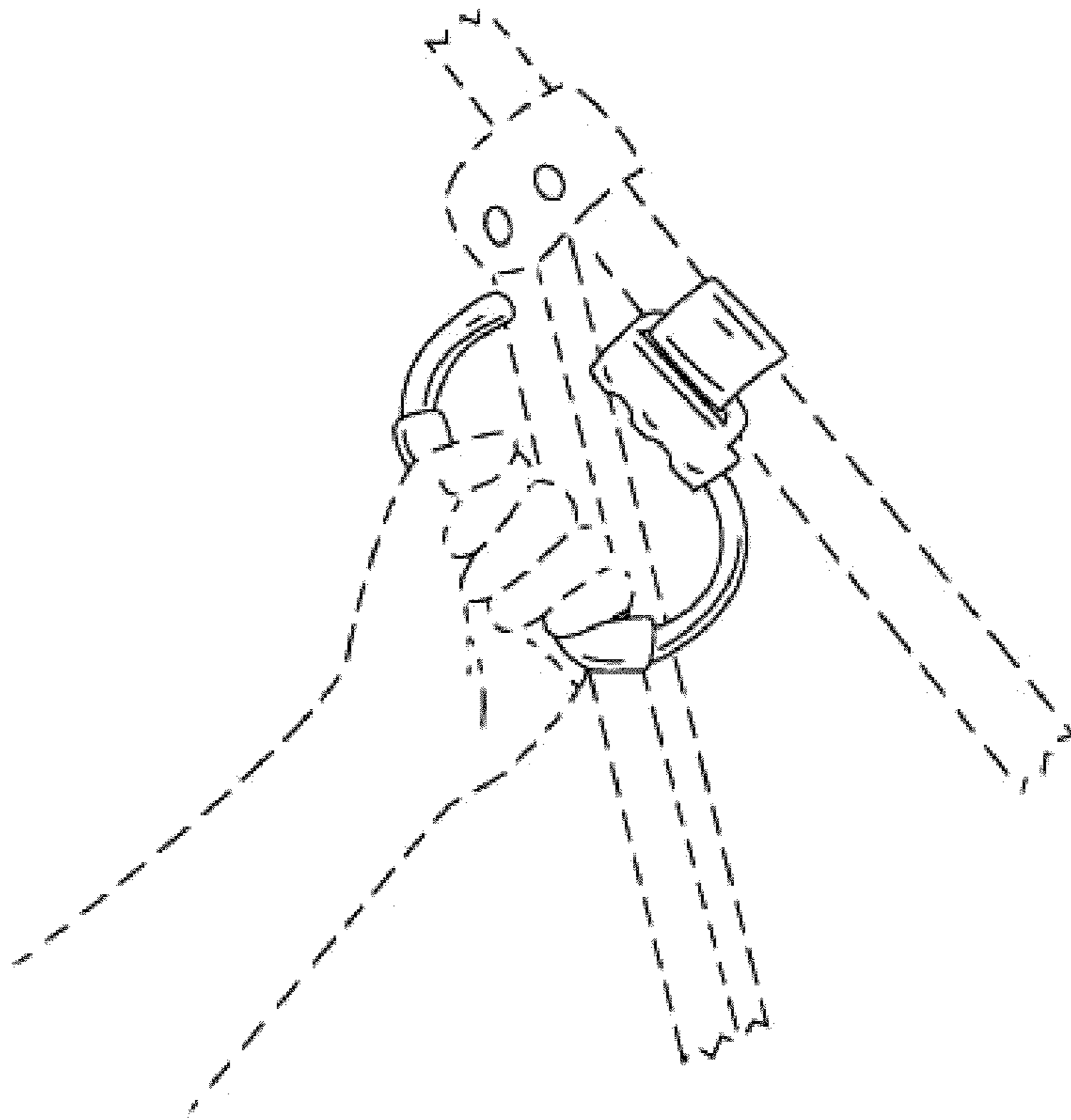

Figure 8