



US00D740640S

(12) **United States Design Patent**
Lai

(10) **Patent No.:** **US D740,640 S**

(45) **Date of Patent:** **** Oct. 13, 2015**

(54) **SCREWDRIVER HANDLE**

(71) Applicant: **Jin-Tsai Lai**, Taichung (TW)

(72) Inventor: **Jin-Tsai Lai**, Taichung (TW)

(**) Term: **14 Years**

(21) Appl. No.: **29/478,571**

(22) Filed: **Jan. 7, 2014**

(51) **LOC (10) Cl.** **08-04**

(52) **U.S. Cl.**
USPC **D8/83**

(58) **Field of Classification Search**
USPC D8/21, 24-26, 29, 61, 82-87, 107;
81/52, 53.1, 58.3, 177.1-177.4, 177.7,
81/467, 480, 489-491
CPC A47J 43/26; B25B 13/463; B25B 13/468;
B25B 15/02; B25B 15/04; B25F 5/029;
B25G 1/005; B25G 1/085; B25H 3/003
See application file for complete search history.

(56) **References Cited**

U.S. PATENT DOCUMENTS

D325,502 S *	4/1992	Rahm et al.	D8/61
D481,922 S *	11/2003	Yu et al.	D8/107
D517,388 S *	3/2006	Hsieh	D8/83
D517,394 S *	3/2006	Chen	D8/107
D550,531 S *	9/2007	Yeh	D8/83
D570,664 S *	6/2008	Tang	D8/83

D600,991 S *	9/2009	Lai	D8/83
D620,338 S *	7/2010	Huang	D8/83
RE42,278 E *	4/2011	Kienzler	D8/82
D636,654 S *	4/2011	Robinson et al.	D8/83
8,443,973 B1 *	5/2013	Hsu	206/374
D686,899 S *	7/2013	Lin	D8/83
D707,527 S *	6/2014	Hsieh	D8/107
D714,121 S *	9/2014	Suter	D8/85
D716,629 S *	11/2014	Suter	D8/82
D720,590 S *	1/2015	Carl	D8/85
D720,591 S *	1/2015	Carl	D8/85

* cited by examiner

Primary Examiner — Phillip S Hyder
Assistant Examiner — Roselynn Cody
(74) *Attorney, Agent, or Firm* — Che-Yang Chen; Law Office of Michael Chen

(57) **CLAIM**
The ornamental design for a screwdriver handle, as shown and described.

DESCRIPTION

FIG. 1 is a perspective view of a screwdriver handle showing my design;
FIG. 2 is a front elevational view thereof;
FIG. 3 is a rear elevational view thereof;
FIG. 4 is a left side elevational view thereof;
FIG. 5 is a right side elevational view thereof;
FIG. 6 is a top plan view thereof; and,
FIG. 7 is a bottom plan view thereof.

1 Claim, 4 Drawing Sheets

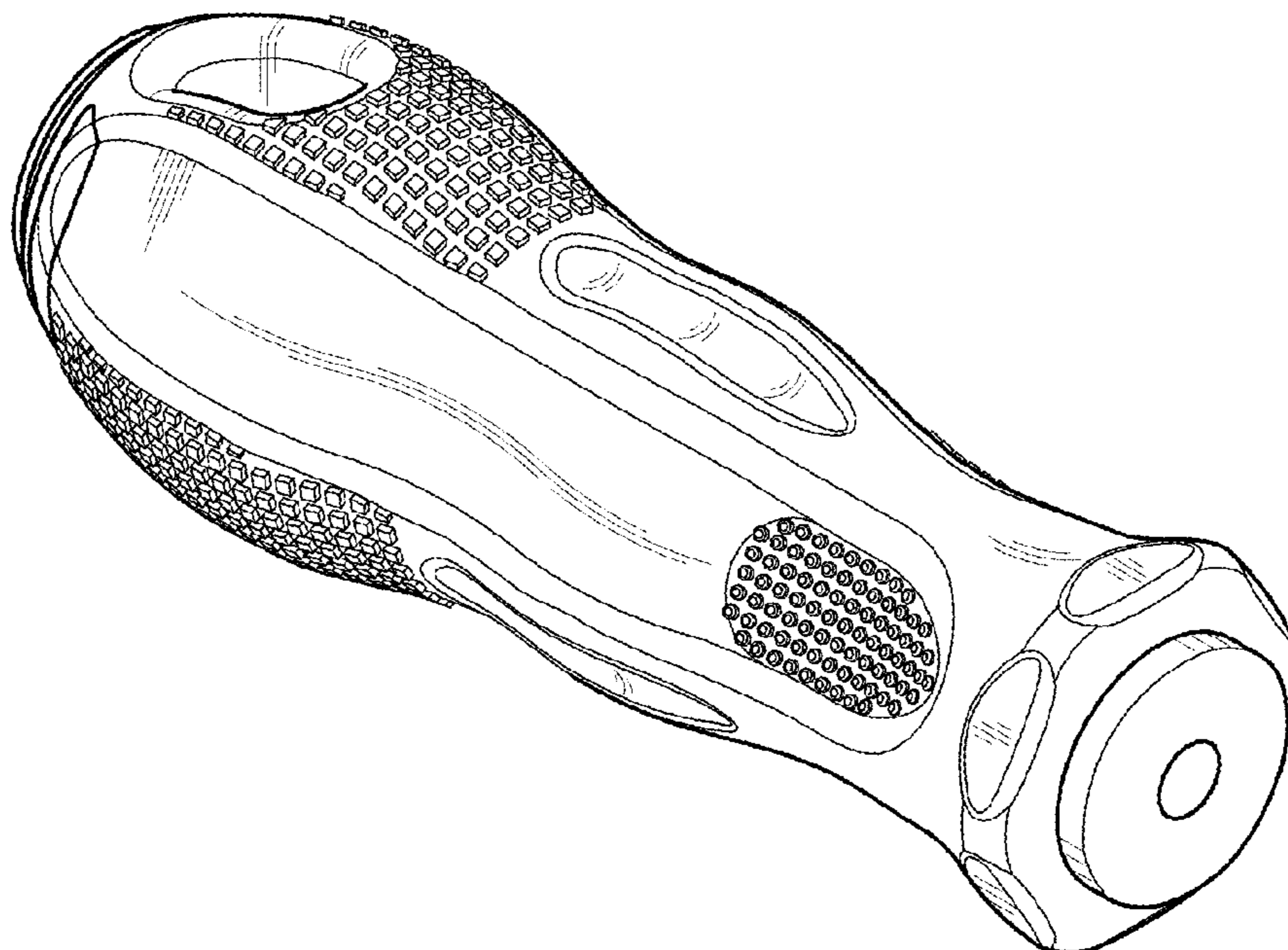

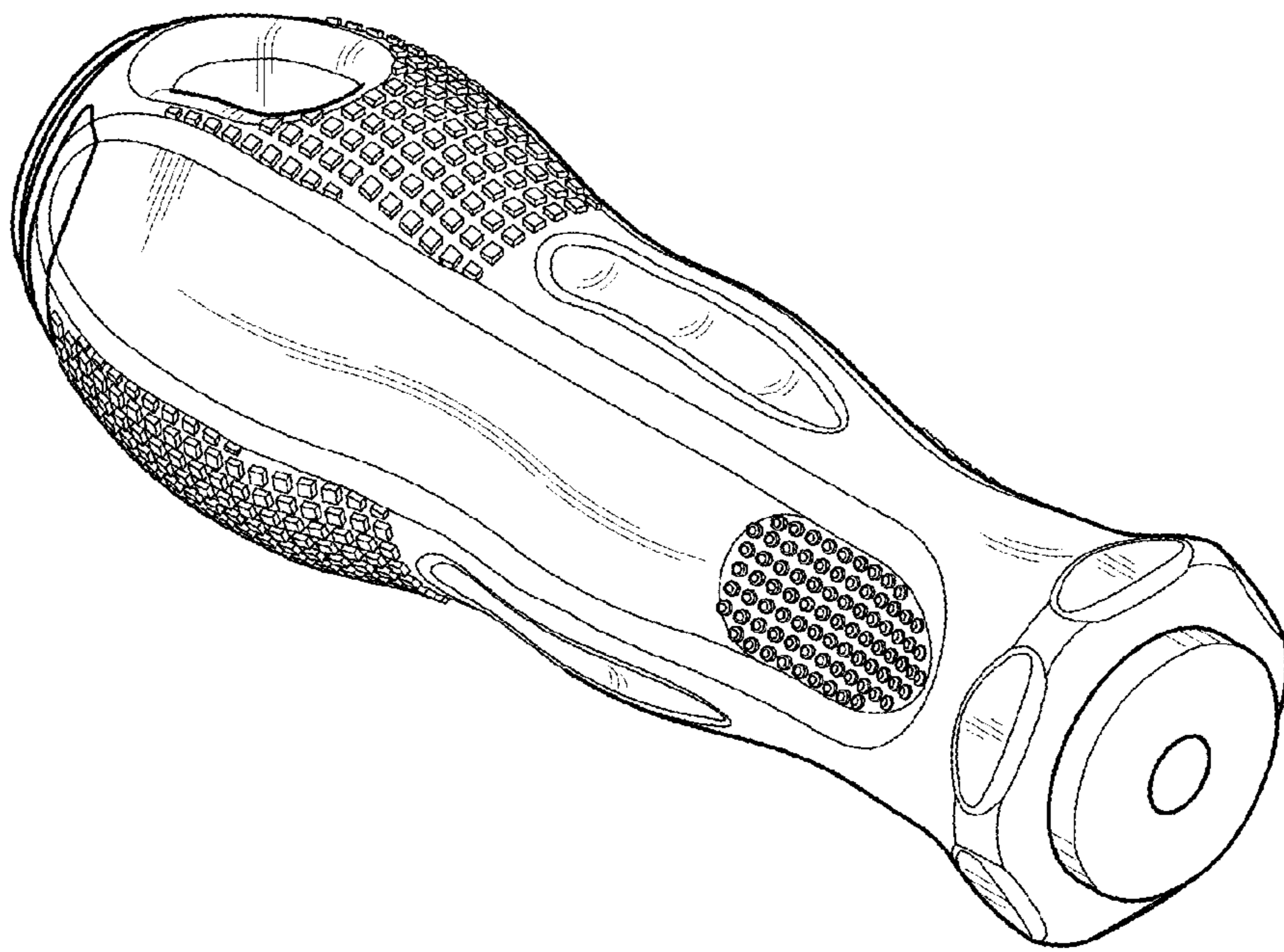

FIG.1

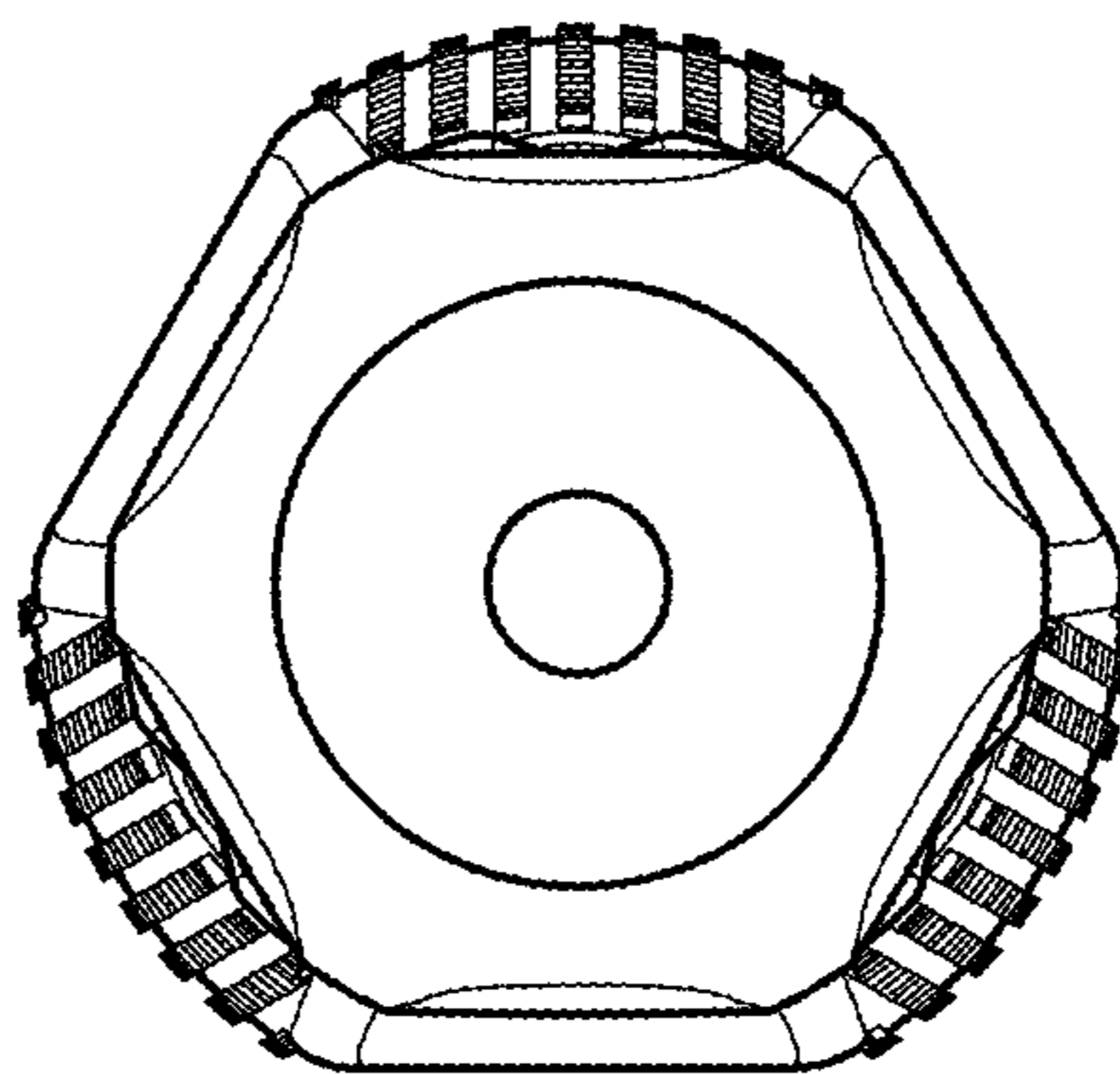

FIG. 2

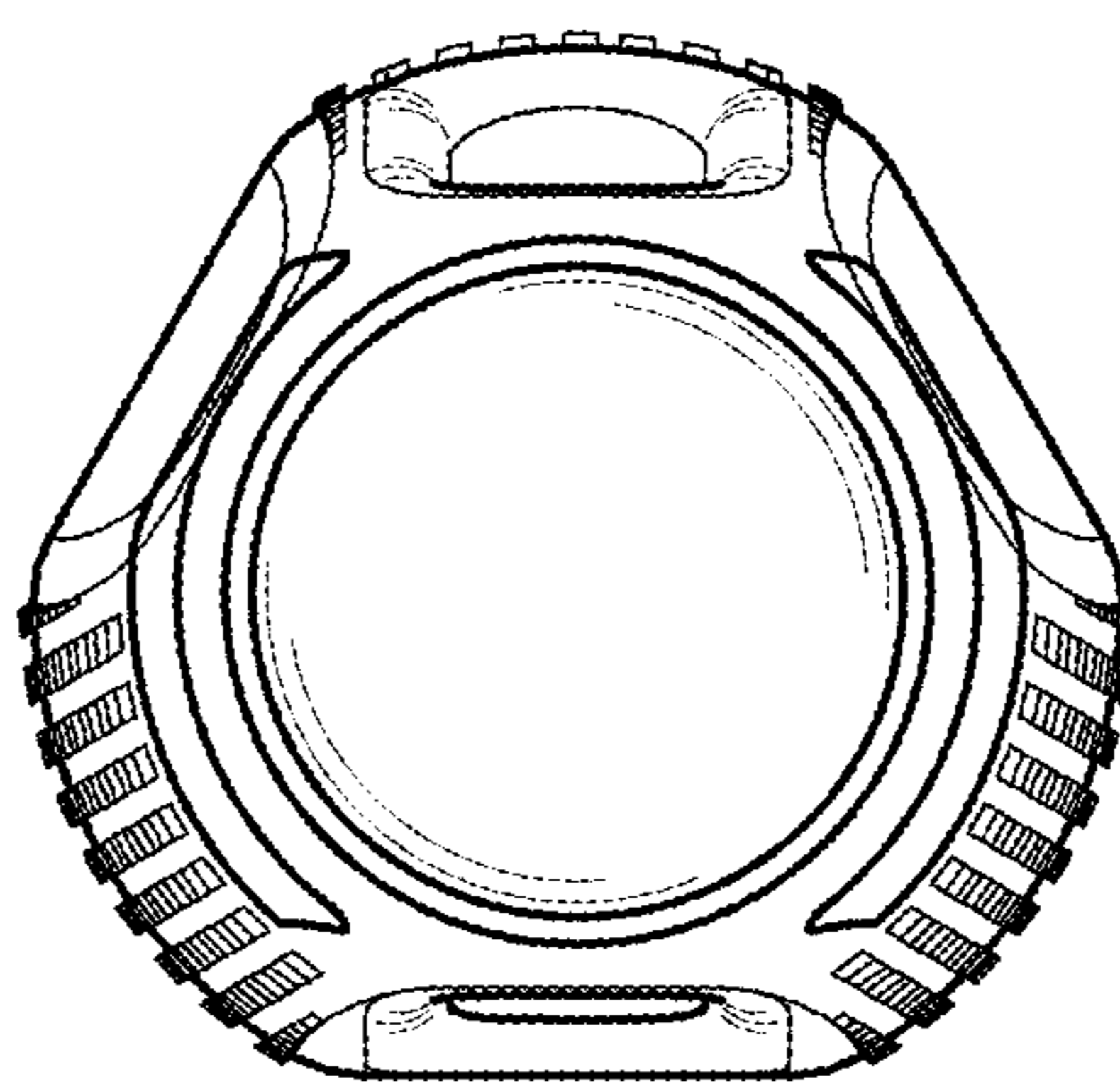

FIG. 3

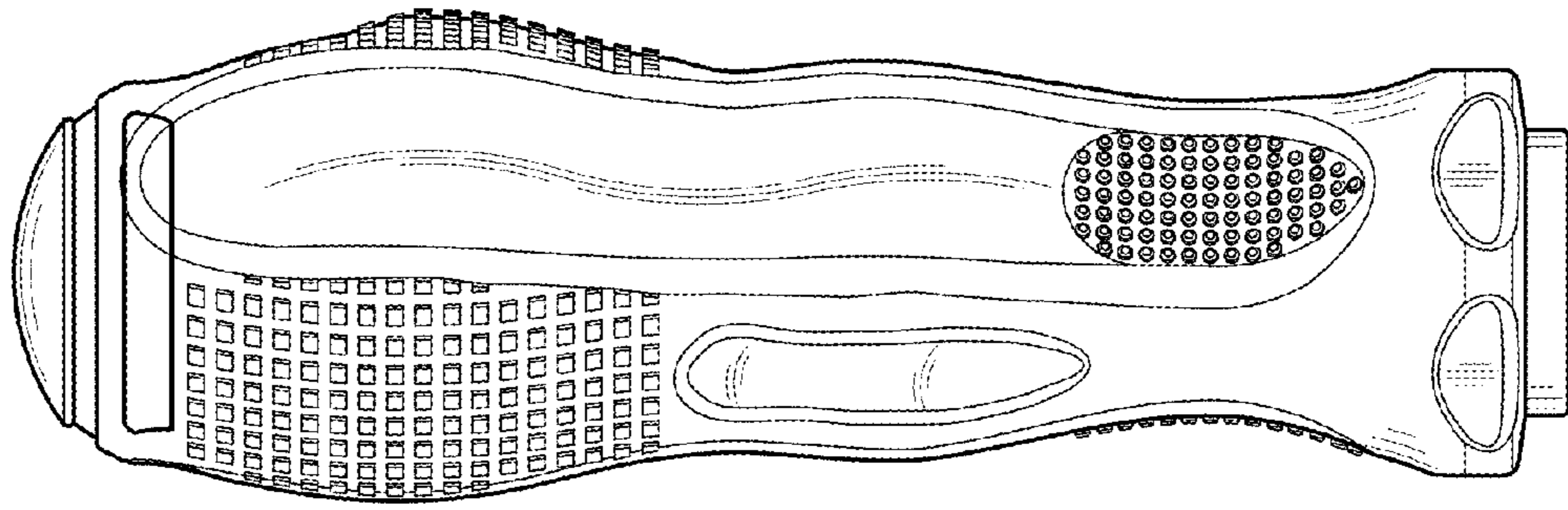

FIG. 4

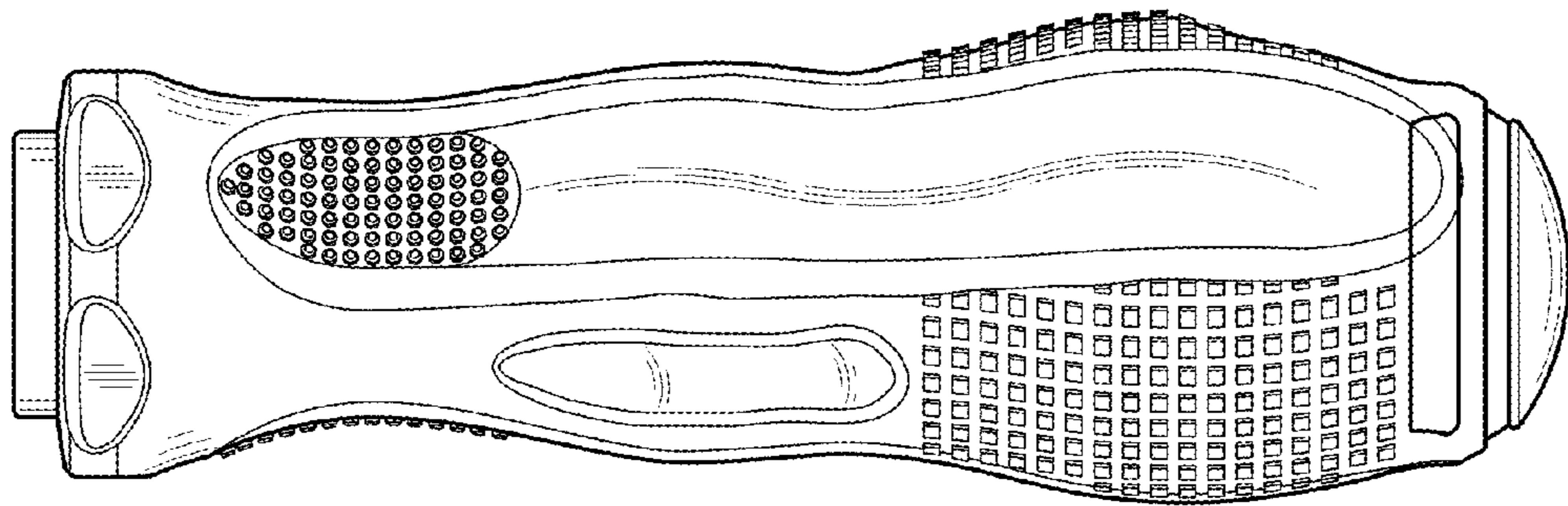

FIG. 5

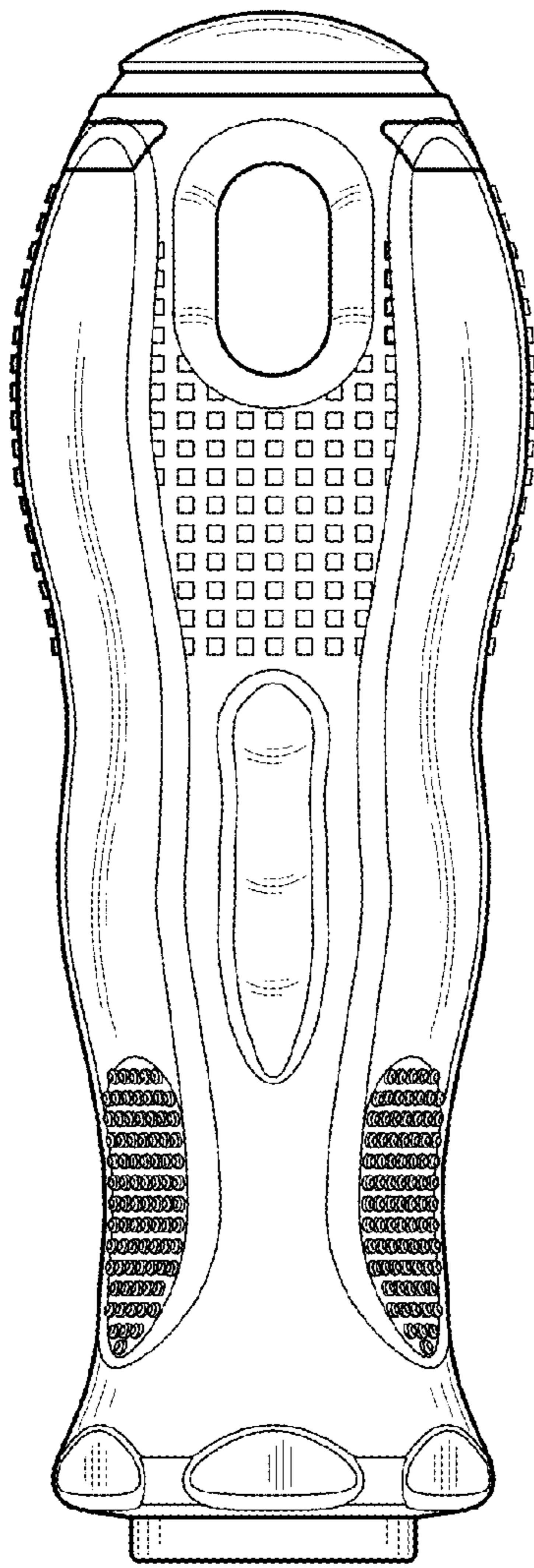

FIG. 6

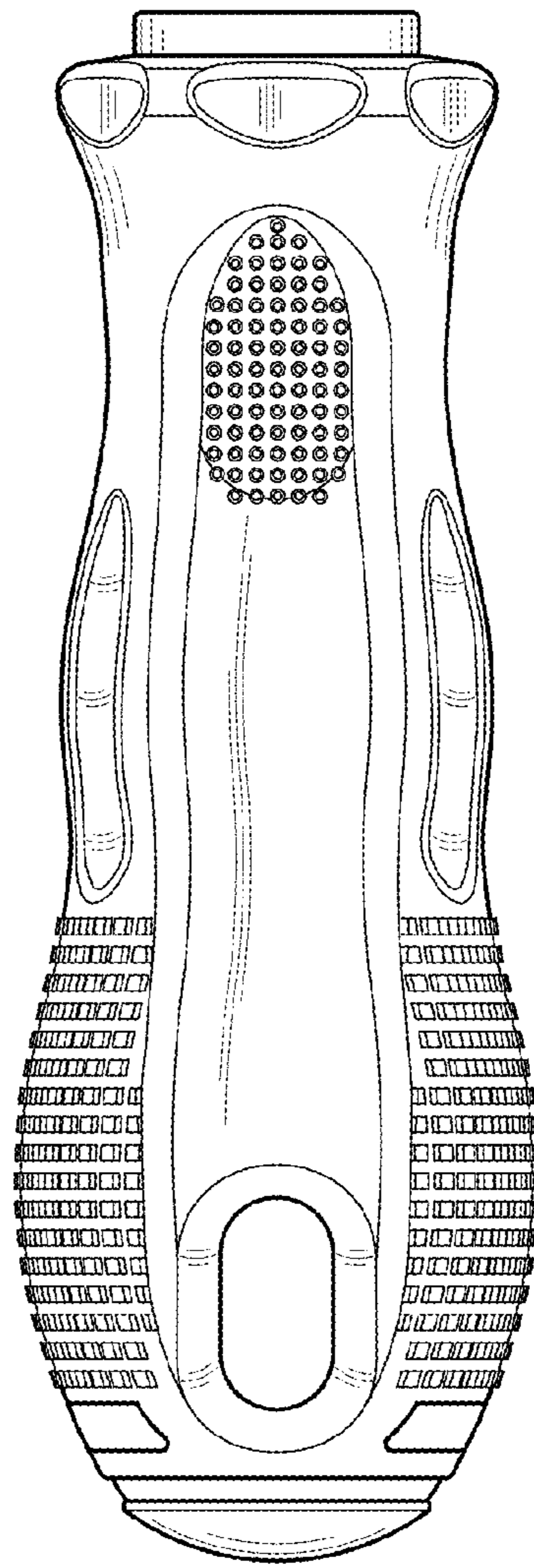

FIG. 7