



US00D740560S

(12) **United States Design Patent**
Pupecki et al.

(10) **Patent No.:** **US D740,560 S**
(45) **Date of Patent:** **** Oct. 13, 2015**

(54) **AUDIO SYSTEM ACCESSORY**

(71) Applicant: **Bose Corporation**, Framingham, MA (US)

(72) Inventors: **Jay Pupecki**, Worcester, MA (US);
Karson Isaiah Shadley, Oakland, CA (US); **Robert Edward Mangum**, San Mateo, CA (US); **Sean Missal**, San Fernando, CA (US)

(73) Assignee: **Bose Corporation**, Framingham, MA (US)

(**) Term: **14 Years**

(21) Appl. No.: **29/484,567**

(22) Filed: **Mar. 11, 2014**

(51) **LOC (10) Cl.** **03-01**

(52) **U.S. Cl.**
USPC **D3/283**

(58) **Field of Classification Search**
USPC D3/216–217, 218, 230, 273, 267, 276,
D3/283, 289, 290, 315; D14/214, 217,
D14/496; 224/615; 381/120, 333–334,
381/387–388

See application file for complete search history.

(56) **References Cited**

U.S. PATENT DOCUMENTS

D261,077 S *	10/1981	Loomis	D3/230
D402,462 S *	12/1998	Sanderson	D3/276
D409,378 S *	5/1999	Lidsky	D3/218
D463,114 S *	9/2002	Carter	D3/218
D469,952 S *	2/2003	Daglow et al.	D3/216
D520,745 S *	5/2006	Hussaini et al.	D3/283
D563,431 S *	3/2008	Entner	D14/496
D566,130 S *	4/2008	Entner	D14/496

* cited by examiner

Primary Examiner — Catheri Oliver-Garcia

(57) **CLAIM**

The ornamental design for an audio system accessory, substantially as shown and described.

DESCRIPTION

FIG. 1 is a perspective view of an audio system accessory as seen from the front, top and side;
FIG. 2 is a front view thereof;
FIG. 3 is a rear view thereof;
FIG. 4 is a side view thereof;
FIG. 5 is an opposite side view thereof;
FIG. 6 is a top view thereof; and,
FIG. 7 is a bottom view thereof.

1 Claim, 4 Drawing Sheets

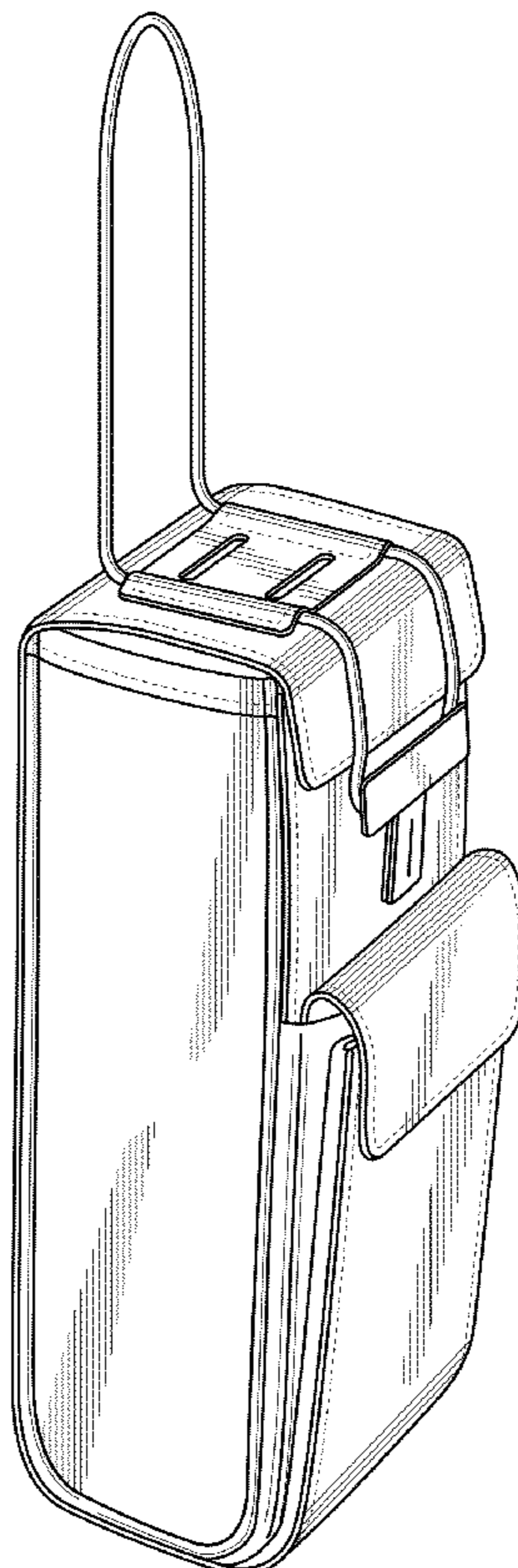

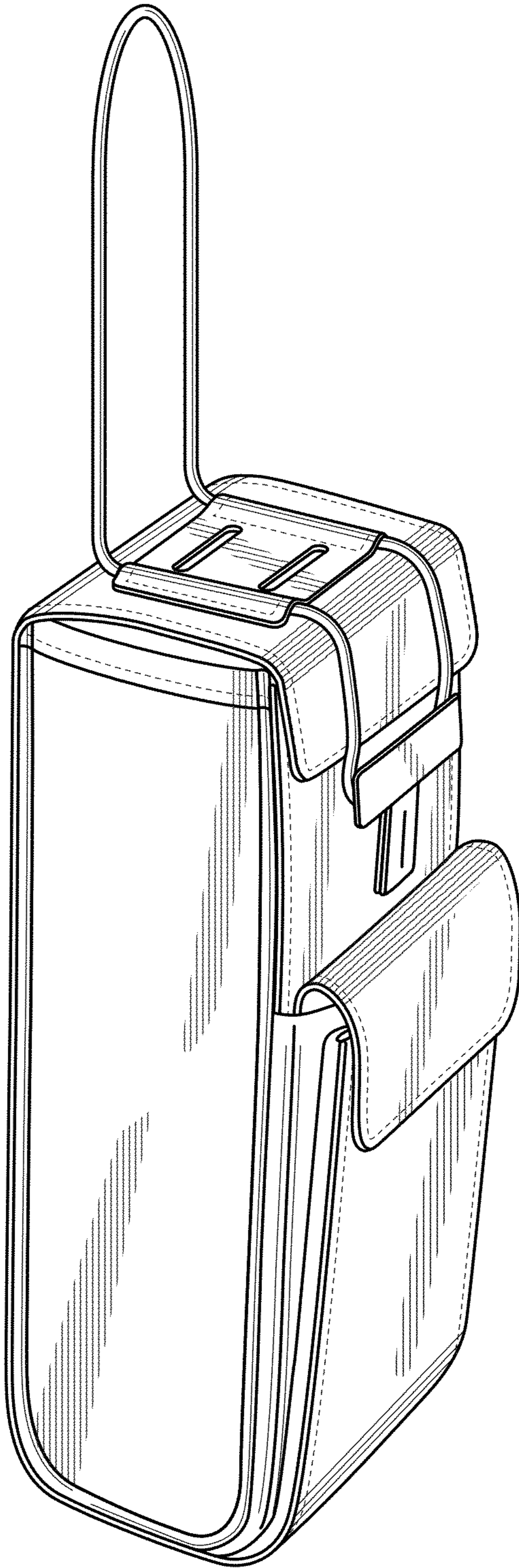

FIG. 1

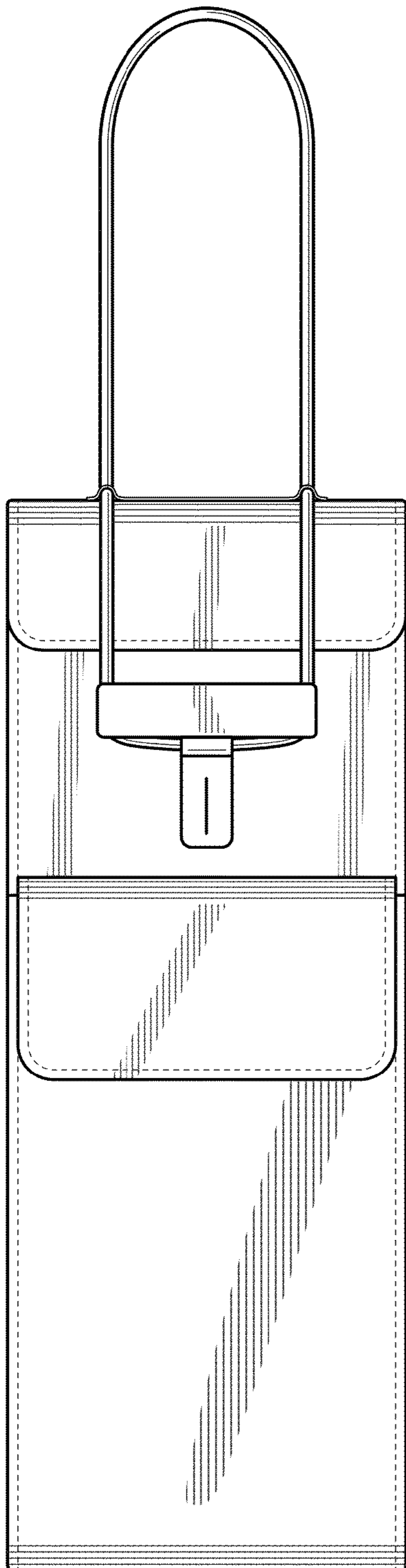

FIG. 2

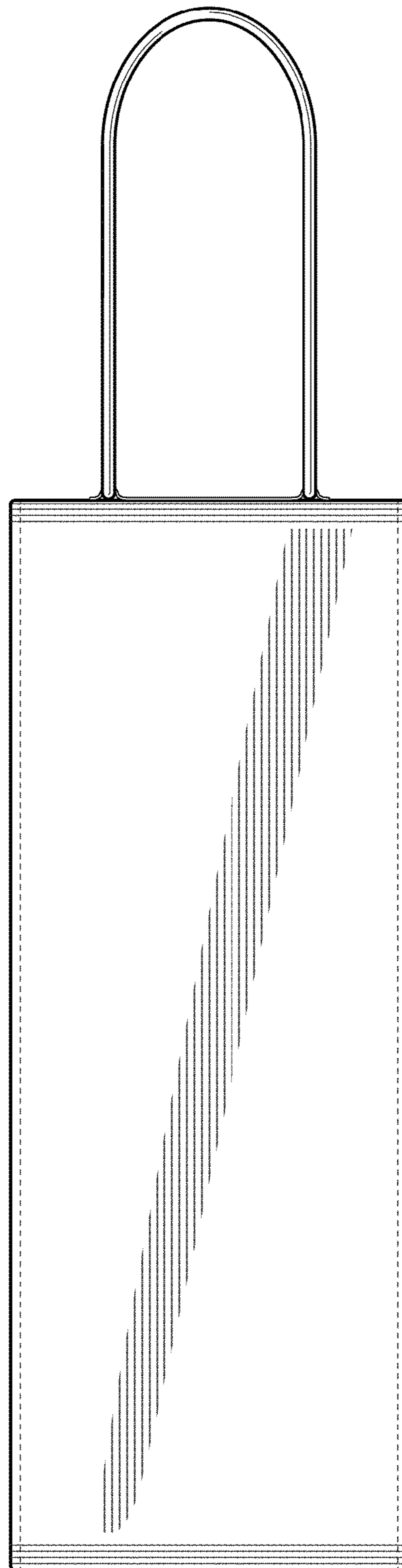

FIG. 3

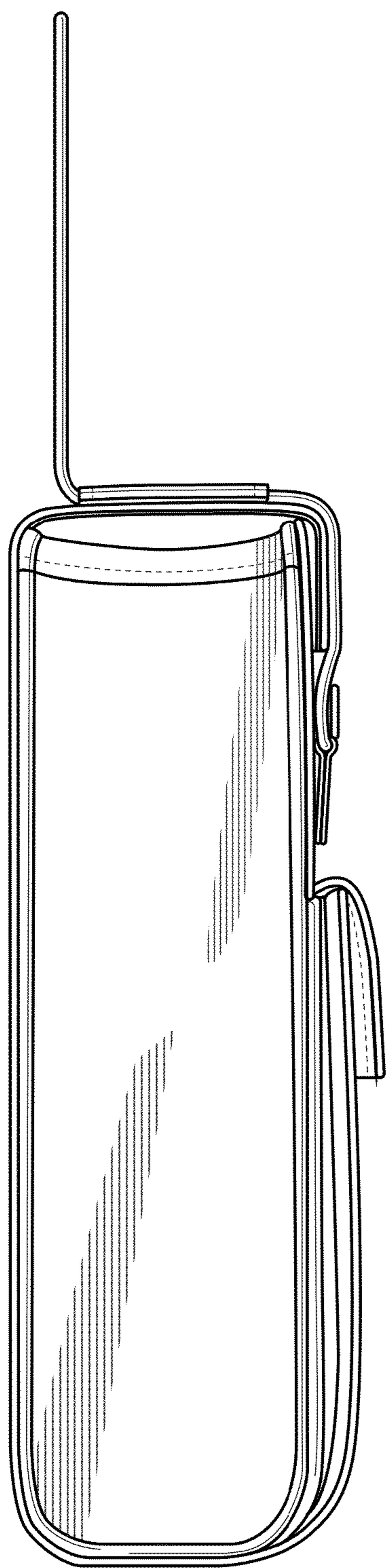

FIG. 4

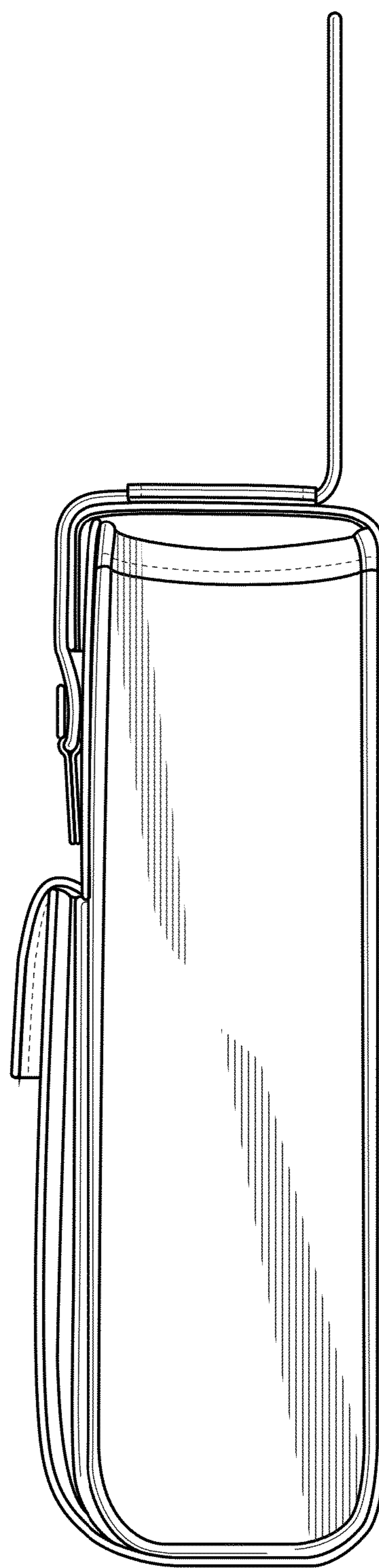

FIG. 5

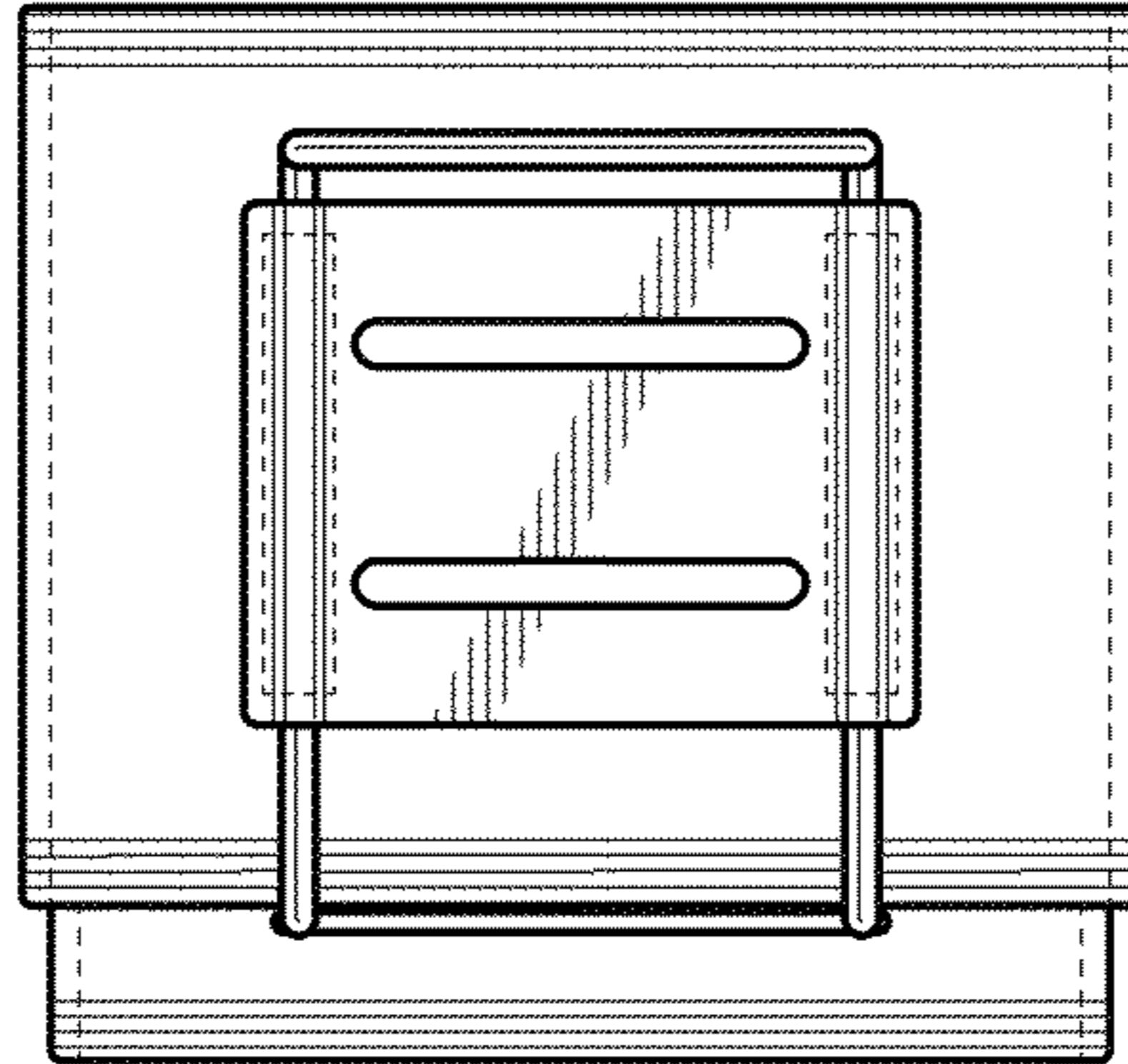

FIG. 6

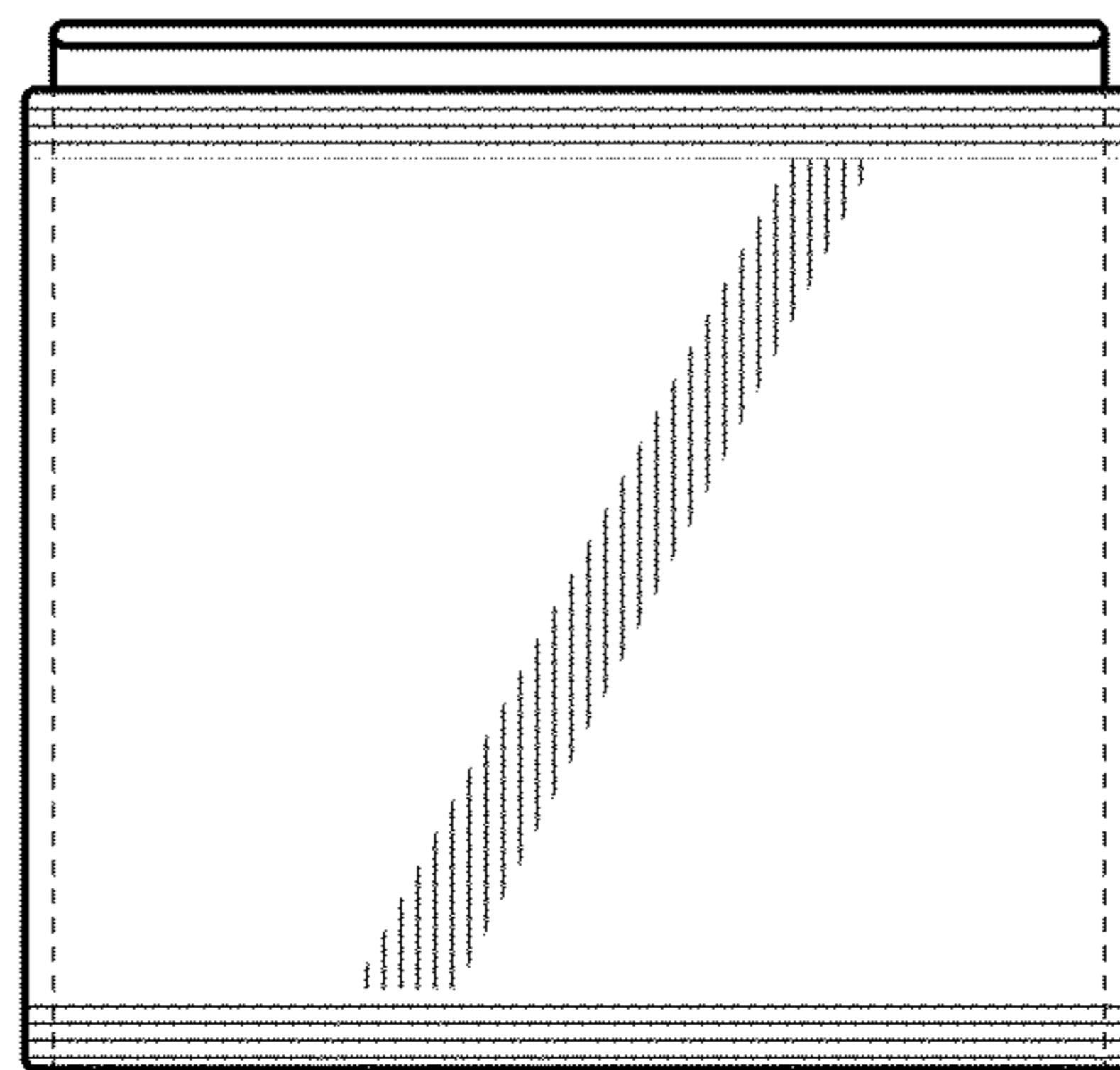

FIG. 7