



US00D740556S

(12) **United States Design Patent**  
**Huber**

(10) **Patent No.:** **US D740,556 S**

(45) **Date of Patent:** **\*\* Oct. 13, 2015**

(54) **CONTAINER**

(71) Applicant: **TELAIR INTERNATIONAL GMBH**,  
Miesbach (DE)

(72) Inventor: **Thomas Huber**, Schliersee (DE)

(73) Assignee: **Telair International GmbH** (DE)

(\*\*) Term: **14 Years**

(21) Appl. No.: **29/503,867**

(22) Filed: **Sep. 30, 2014**

**Related U.S. Application Data**

(62) Division of application No. 29/438,756, filed on Dec. 3, 2012.

(30) **Foreign Application Priority Data**

Jun. 6, 2012 (EM) ..... 002053090-0001  
Jun. 6, 2012 (EM) ..... 002053090-0002  
Jun. 6, 2012 (EM) ..... 002053090-0003  
Jun. 6, 2012 (EM) ..... 002053090-0004

(51) **LOC (10) Cl.** ..... **03-01**

(52) **U.S. Cl.**  
USPC ..... **D3/272; D9/414**

(58) **Field of Classification Search**

USPC ..... D9/702-714, 720-721, 414, 420,  
D9/424-425, 431-432, 435; 119/496-499,  
119/491, 482, 453, 474; 206/434, 427, 467,  
206/386; 220/495.03, 1.5, 3.3, 545, 607;  
229/122, 200, 87.01, 87.19, 116.1,  
229/103.2; D30/108-109, 118; D3/201,  
D3/273, 232, 287, 276, 272, 215, 282, 217,  
D3/225, 218, 226; 383/6, 17-22, 66,  
383/121.1, 108, 33; 222/92-95; 312/297;  
217/7, 5  
CPC .. B65D 77/06; B65D 77/0406; B65D 77/003;  
B65D 88/14; B65D 88/129; B65D 88/12;  
B65D 88/121

See application file for complete search history.

(56) **References Cited**

U.S. PATENT DOCUMENTS

1,412,694	A *	4/1922	Loughran	.....	220/6
3,208,619	A *	9/1965	Kridle et al.	.....	220/4.31
D209,336	S *	11/1967	Dykes et al.	.....	D9/414
3,645,596	A *	2/1972	Russell-French	.....	312/258
3,692,203	A *	9/1972	Byrd et al.	.....	220/1.5
D228,744	S *	10/1973	Farkas	.....	D9/714
3,915,327	A *	10/1975	Lovich et al.	.....	220/1.5
D245,319	S *	8/1977	Wodell	.....	D3/272
4,212,406	A *	7/1980	Mittelmann	.....	220/1.5
D275,836	S *	10/1984	Forbes, Jr.	.....	D9/418
D276,137	S *	10/1984	Vere et al.	.....	D9/702
D307,718	S *	5/1990	Tabler	.....	D9/432
D319,179	S *	8/1991	Holder	.....	D9/711
D337,270	S *	7/1993	Brockman	.....	D9/430
5,398,831	A *	3/1995	Avramides et al.	.....	220/1.5
5,890,612	A *	4/1999	Coppi	.....	220/7
6,161,714	A *	12/2000	Matsuura et al.	.....	220/1.5

(Continued)

*Primary Examiner* — Caron D Veynar

*Assistant Examiner* — Abraham Bahta

(74) *Attorney, Agent, or Firm* — Barnes & Thornburg LLP

(57) **CLAIM**

The ornamental design for a container, as shown and described.

**DESCRIPTION**

FIG. 1 is a perspective view of the container showing the rear, right side and top of the container;  
FIG. 2 is a bottom view of the container;  
FIG. 3 is a right side view of the container;  
FIG. 4 is a left side view of the container;  
FIG. 5 is a top view of the container; and,  
FIG. 6 is a front view of the container.  
The front of the container is open and is devoid of surface ornamentation.

**1 Claim, 6 Drawing Sheets**

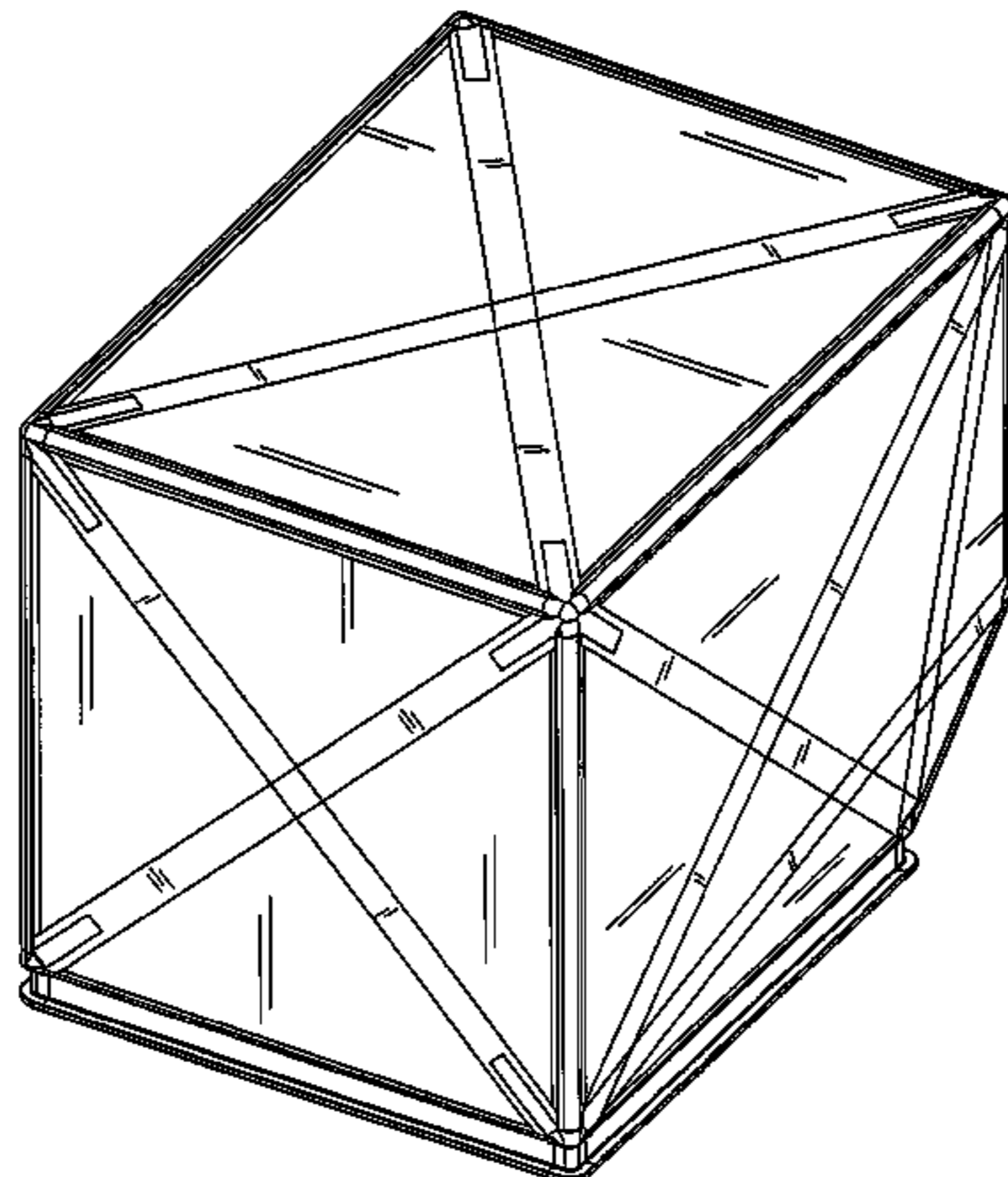

(56)

**References Cited**

U.S. PATENT DOCUMENTS

D451,794 S \* 12/2001 Ichikawa ..... D9/709  
6,824,338 B2 \* 11/2004 Looker ..... 410/67  
7,063,227 B2 \* 6/2006 Looker ..... 220/345.1  
D544,369 S \* 6/2007 Liu ..... D9/704

D555,008 S \* 11/2007 Gattino ..... D9/702  
D590,244 S \* 4/2009 Demalsche et al. .... D9/414  
8,800,797 B2 \* 8/2014 Fingerhut et al. .... 220/88.1  
D721,890 S \* 2/2015 Heil et al. .... D3/272  
D734,029 S \* 7/2015 Lee, II ..... D3/272

\* cited by examiner

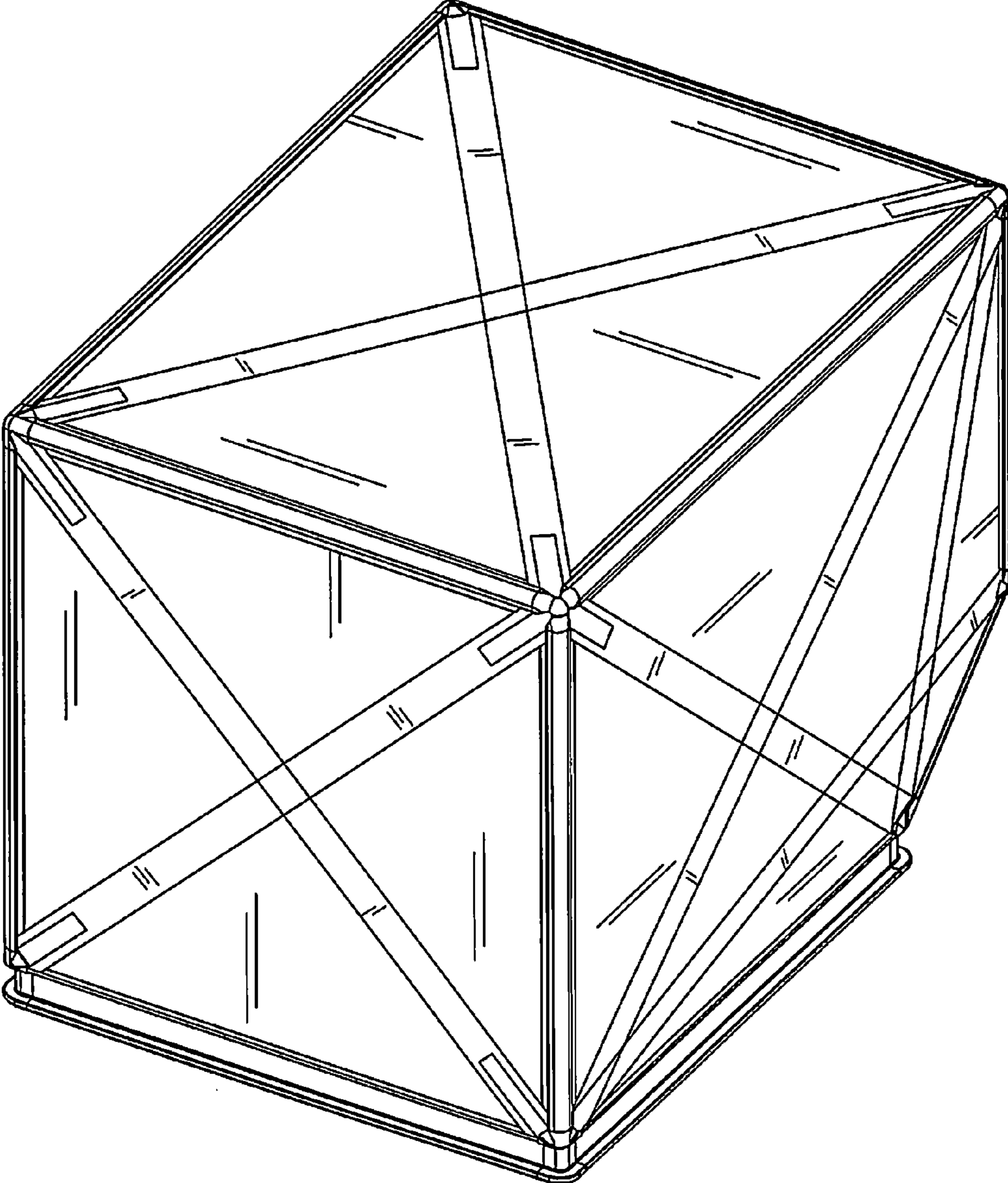

FIG. 1

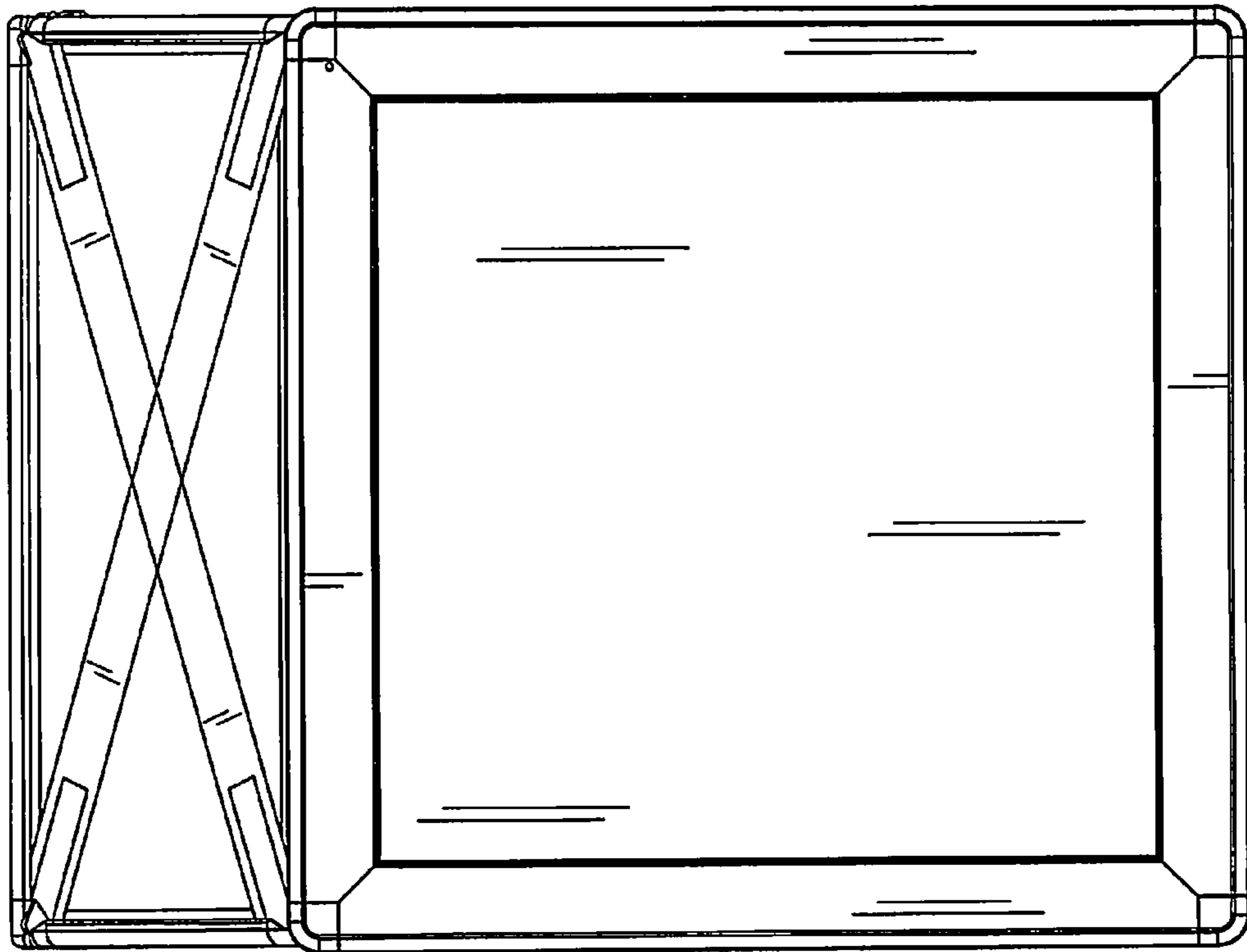

FIG. 2

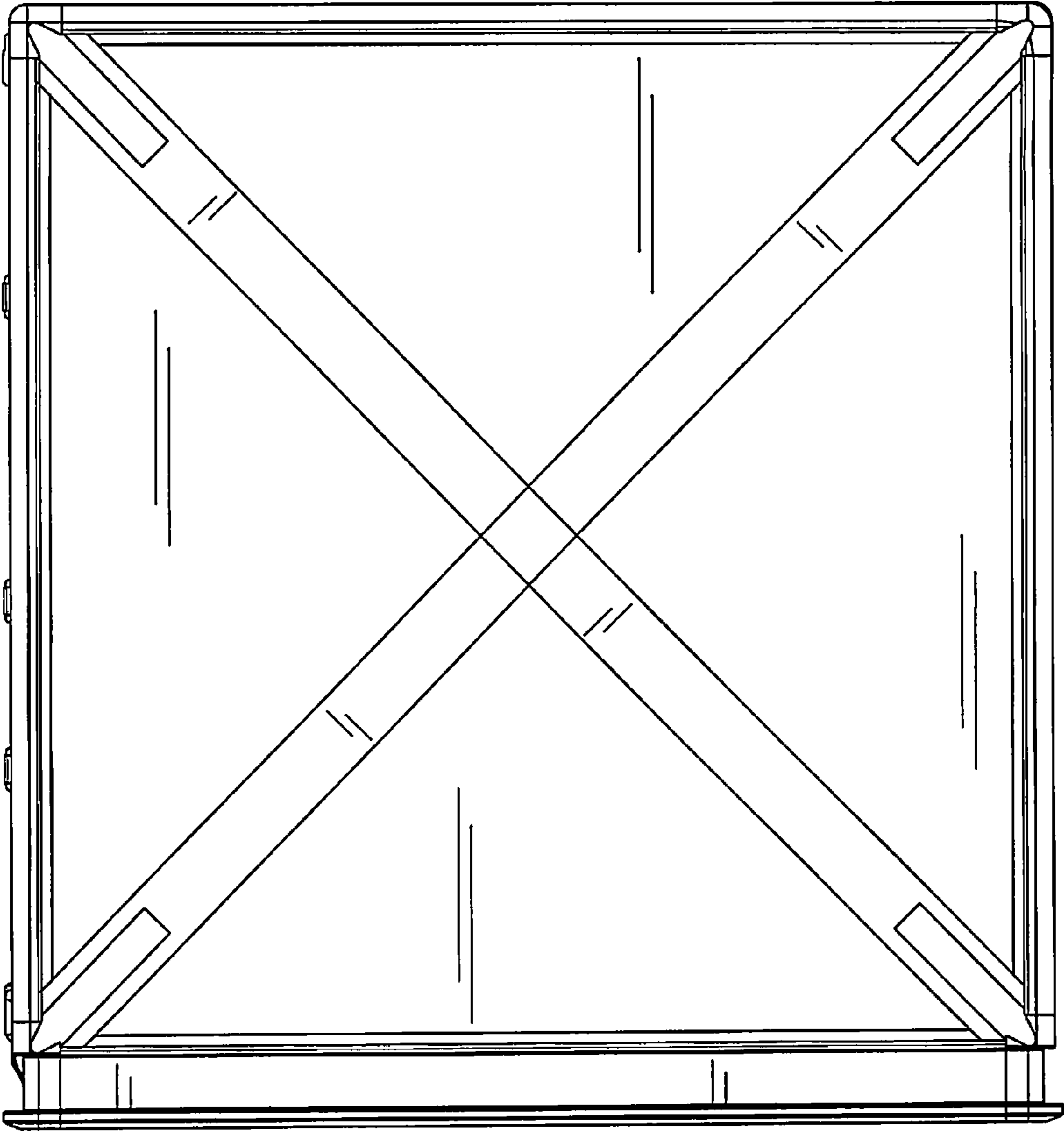

FIG. 3



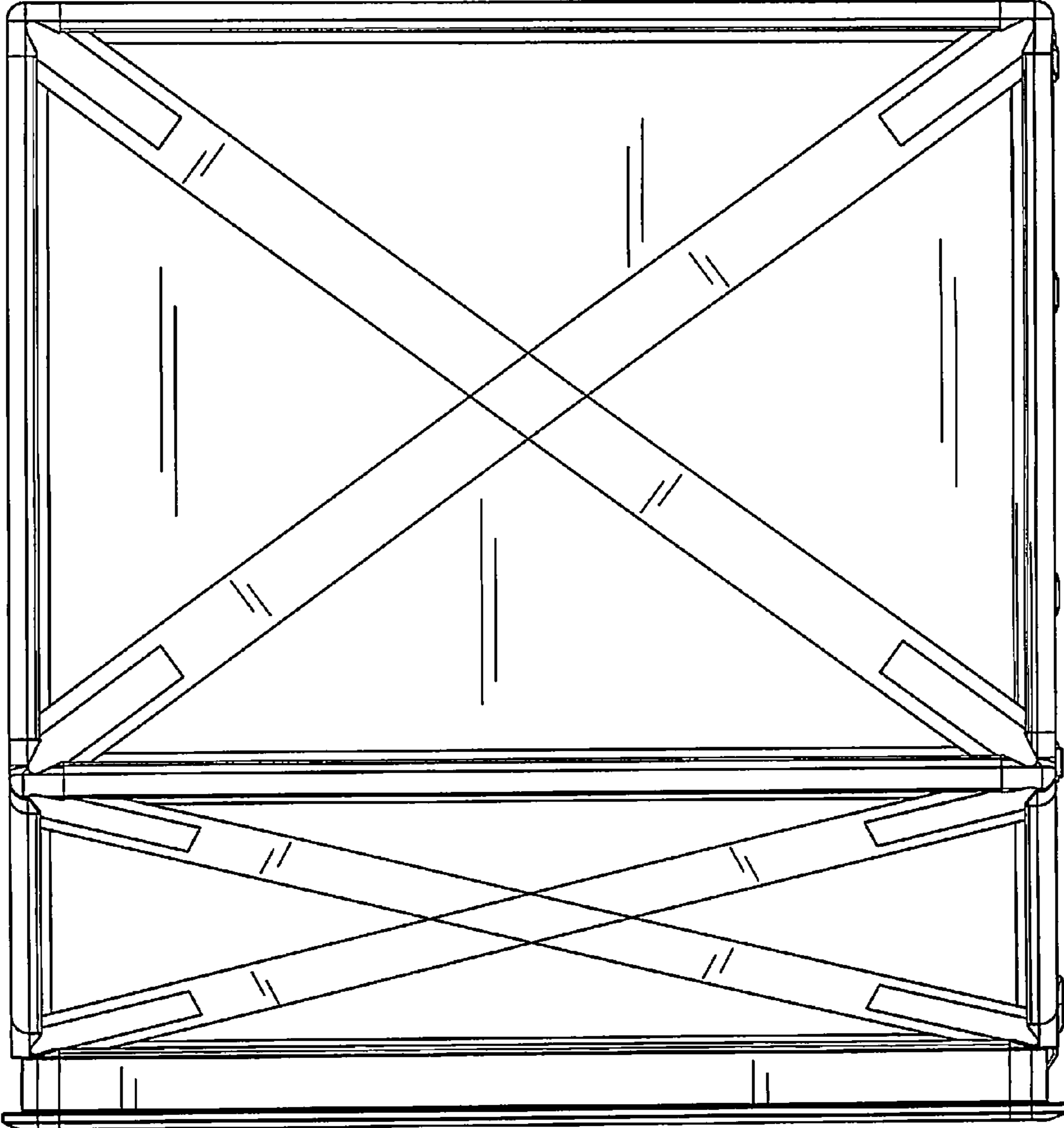

FIG. 4

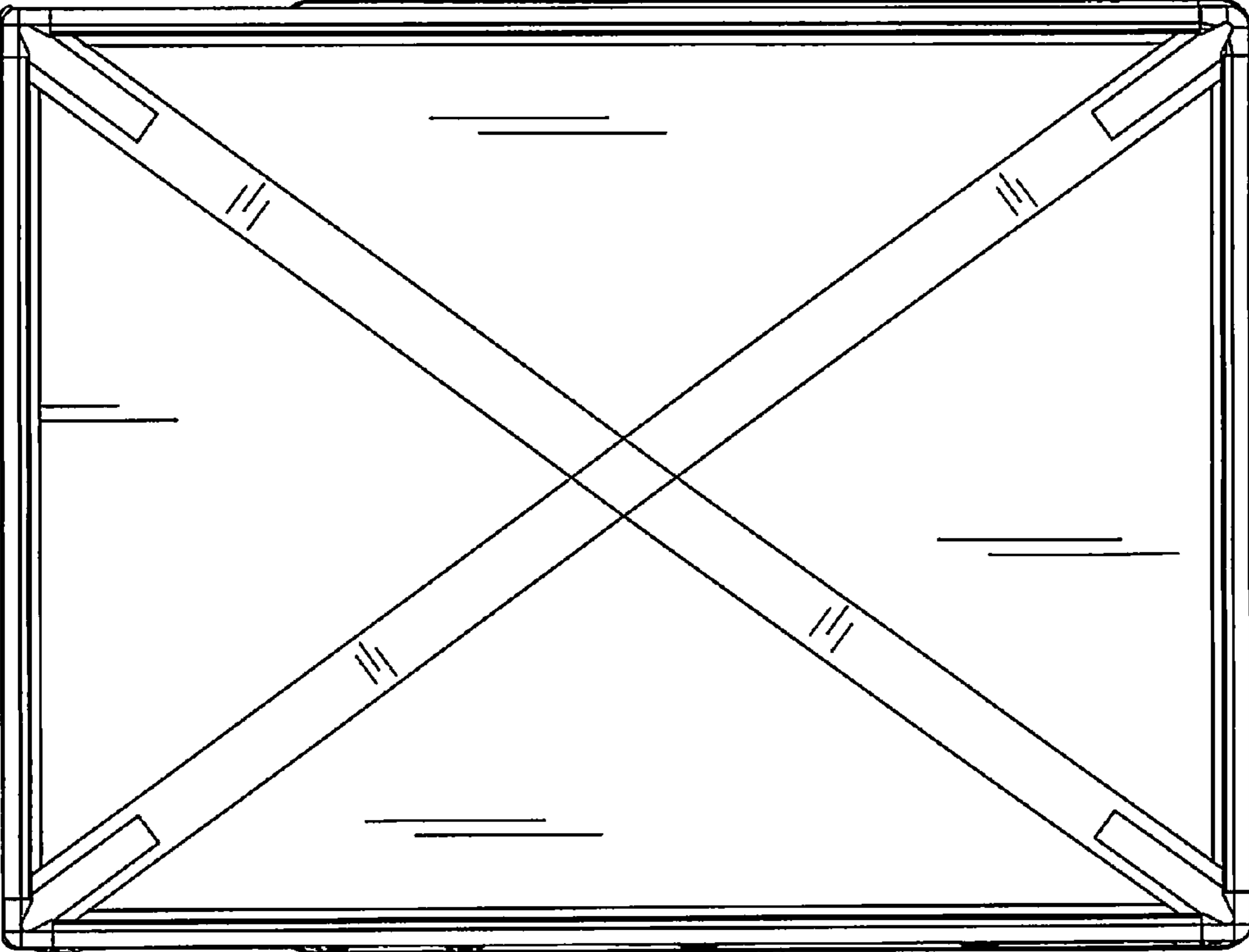

FIG. 5

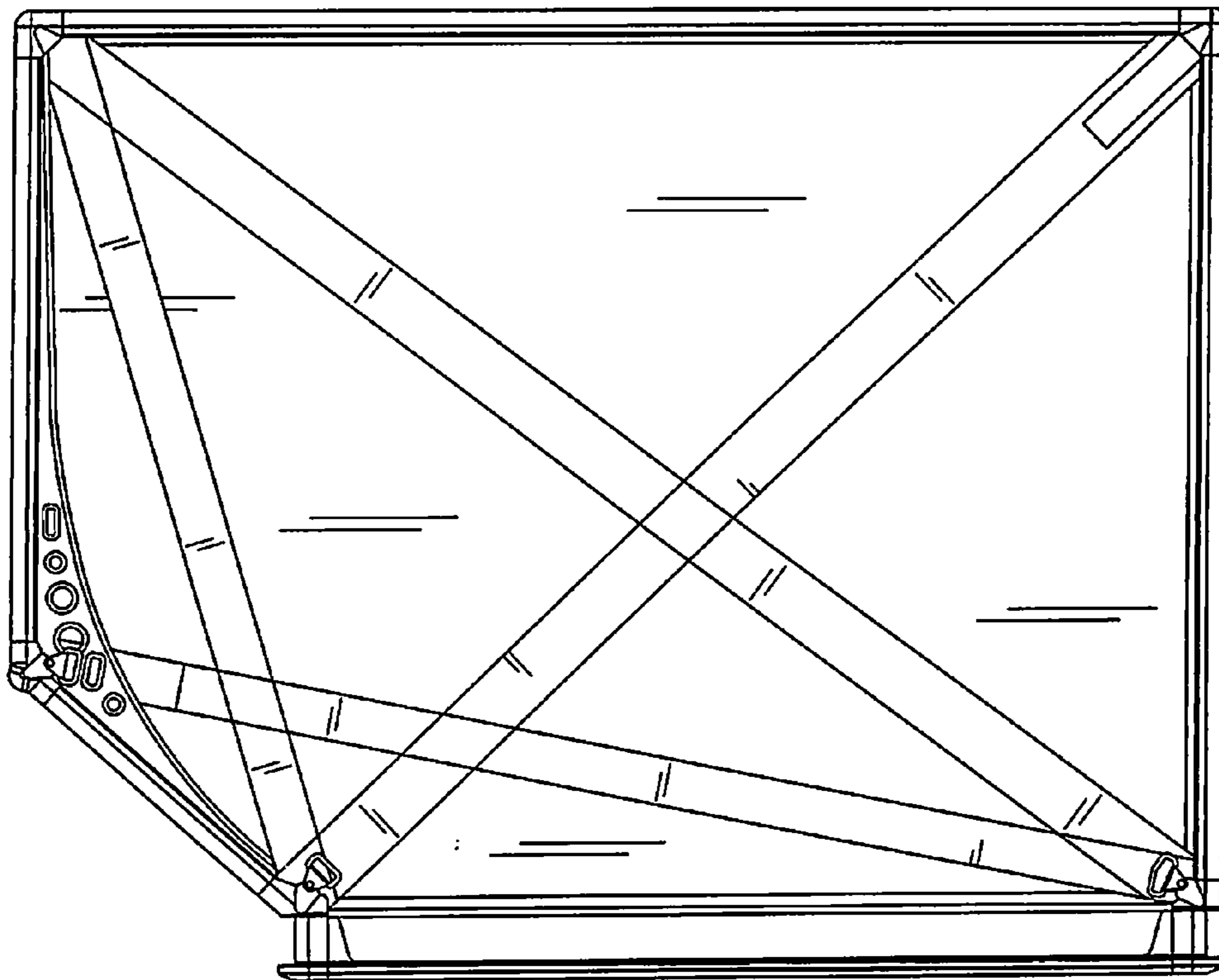

FIG. 6