



US00D740497S

(12) **United States Design Patent**
Richardson et al.

(10) **Patent No.:** **US D740,497 S**

(45) **Date of Patent:** **** Oct. 6, 2015**

- (54) **PET BED**
- (71) Applicant: **Kruger Co., LLC**, Marietta, GA (US)
- (72) Inventors: **Lyle Richardson**, Marietta, GA (US);
Mark J. Popkin, Marietta, GA (US);
Matthew W. McIsaac, Atlanta, GA (US);
Phillip B. Jones, Marietta, GA (US);
Kevin Michael Kruger, Norman, OK (US)
- (73) Assignee: **Kruger Co., LLC**, Marietta, GA (US)
- (**) Term: **14 Years**
- (21) Appl. No.: **29/497,259**
- (22) Filed: **Jul. 22, 2014**

3,814,426 A 6/1974 Moe
 D263,543 S 3/1982 Daugherty
 4,961,930 A 10/1990 Perdelwitz, Jr. et al.
 5,357,901 A 10/1994 Batts

(Continued)

OTHER PUBLICATIONS

United States Patent and Trademark Office, Ex Parte Quayle Action for U.S. Appl. No. 29/443,036, May 16, 2013, 9 pages, USA.

(Continued)

Primary Examiner — Cathy Anne MacCormac

(74) *Attorney, Agent, or Firm* — Alston & Bird LLP

(57) **CLAIM**

We claim the ornamental design for a pet bed, as shown and described.

DESCRIPTION

FIG. 1 is a top right perspective view of an embodiment of a pet bed showing our new design;
 FIG. 2 is a front elevation view thereof;
 FIG. 3 is a rear elevation view thereof;
 FIG. 4 is a left side elevation view thereof;
 FIG. 5 is a right side elevation view thereof;
 FIG. 6 is a top plan view thereof;
 FIG. 7 is a cross section elevational view of an interior portion of FIG. 1 taken along line 7-7 shown in FIG. 6;
 FIG. 8 is a cross section elevational view of an interior portion of FIG. 1 taken along line 8-8 shown in FIG. 6;
 FIG. 9 is a cross section elevational view of an interior portion of FIG. 1 taken along line 9-9 shown in FIG. 6; and,
 FIG. 10 is a cross section elevational view of an interior portion of FIG. 1 taken along line 10-10 shown in FIG. 6.
 The broken lines shown herein depict environmental subject matter and form no part of the claimed design. The bottom of the pet bed is flat and devoid of ornamentation.

Related U.S. Application Data

- (63) Continuation-in-part of application No. 29/443,044, filed on Jan. 11, 2013, now abandoned.
- (51) **LOC (10) Cl.** **30-06**
- (52) **U.S. Cl.**
USPC **D30/118; D6/597; D6/707.13**
- (58) **Field of Classification Search**
USPC D30/118; D6/349, 595-597, 601, D6/707.13; 119/28.5; D21/339; 273/247
CPC A01K 1/035; A01K 29/00; A47G 9/00; A47G 9/02; A47G 9/10; A47G 9/007; A47G 9/1009; A47G 2009/1018
See application file for complete search history.

(56) **References Cited**

U.S. PATENT DOCUMENTS

2,032,248 A 2/1936 Bins
 2,460,541 A 2/1949 Siler
 D230,539 S 3/1974 Aires

1 Claim, 7 Drawing Sheets

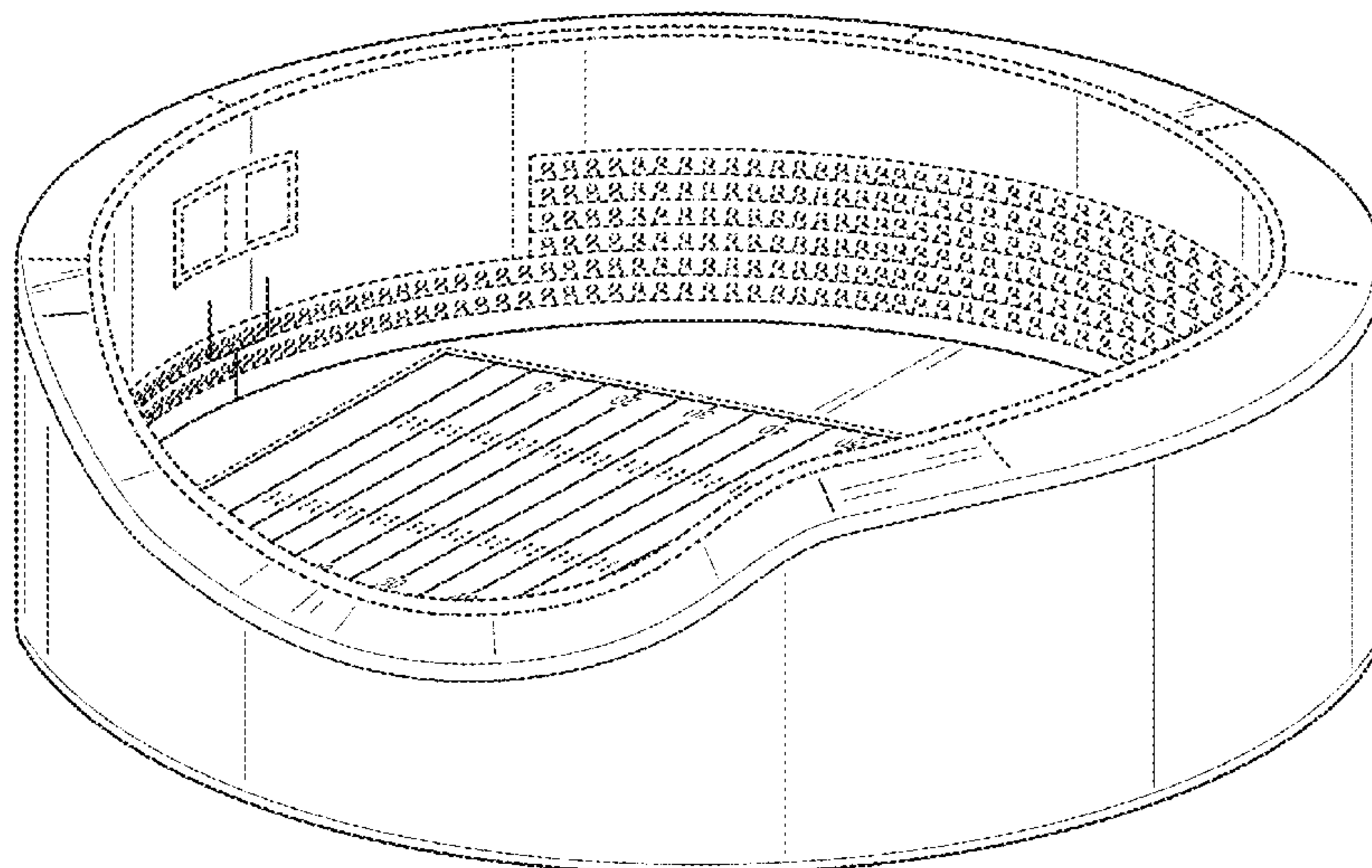

(56)

References Cited

U.S. PATENT DOCUMENTS

5,588,393 A 12/1996 Heilborn
 5,749,314 A 5/1998 Pelham et al.
 D420,400 S 2/2000 Dunagin, III
 D423,729 S 4/2000 Morgan
 D429,912 S 8/2000 Peterson
 D441,146 S 4/2001 Passmore
 D488,335 S * 4/2004 Kerr D6/707.13
 6,851,385 B1 2/2005 Poss et al.
 D550,406 S 9/2007 West
 D561,401 S 2/2008 Martin et al.
 D563,058 S 2/2008 Lamstein et al.
 D565,804 S 4/2008 Song
 D572,936 S 7/2008 Lester, Sr. et al.
 D577,158 S 9/2008 Song
 D580,601 S 11/2008 Song
 D587,920 S 3/2009 Lester, Sr. et al.
 D588,391 S 3/2009 Smith, Jr.
 D589,655 S 3/2009 West
 D600,044 S * 9/2009 Lester et al. D6/388
 7,765,952 B1 8/2010 Archibald

8,360,433 B2 * 1/2013 Poulos 273/247
 D677,014 S 2/2013 Duvigneau
 8,397,672 B2 3/2013 Zine
 D703,877 S * 4/2014 Popkin et al. D30/118
 D728,168 S * 4/2015 Richardson D30/118
 2005/0224000 A1 10/2005 Holte
 2008/0235869 A1 * 10/2008 Steffes 5/282.1
 2011/0239946 A1 * 10/2011 Ogle 119/28.5

OTHER PUBLICATIONS

United States Patent and Trademark Office, Notice of Allowance for U.S. Appl. No. 29/443,036, Jul. 19, 2013, 3 pages, USA.
 United States Patent and Trademark Office, Office Action for U.S. Appl. No. 29/443,050, Aug. 28, 2013, 15 pages, USA.
 United States Patent and Trademark Office, Office Action for U.S. Appl. No. 29/443,046, Jun. 20, 2013, 14 pages, USA.
 United States Patent and Trademark Office, Office Action for U.S. Appl. No. 29/443,044, Aug. 28, 2013, 15 pages, USA.
 United States Patent and Trademark Office, Office Action for U.S. Appl. No. 29/443,044, Jan. 22, 2014, 15 pages, USA.

* cited by examiner

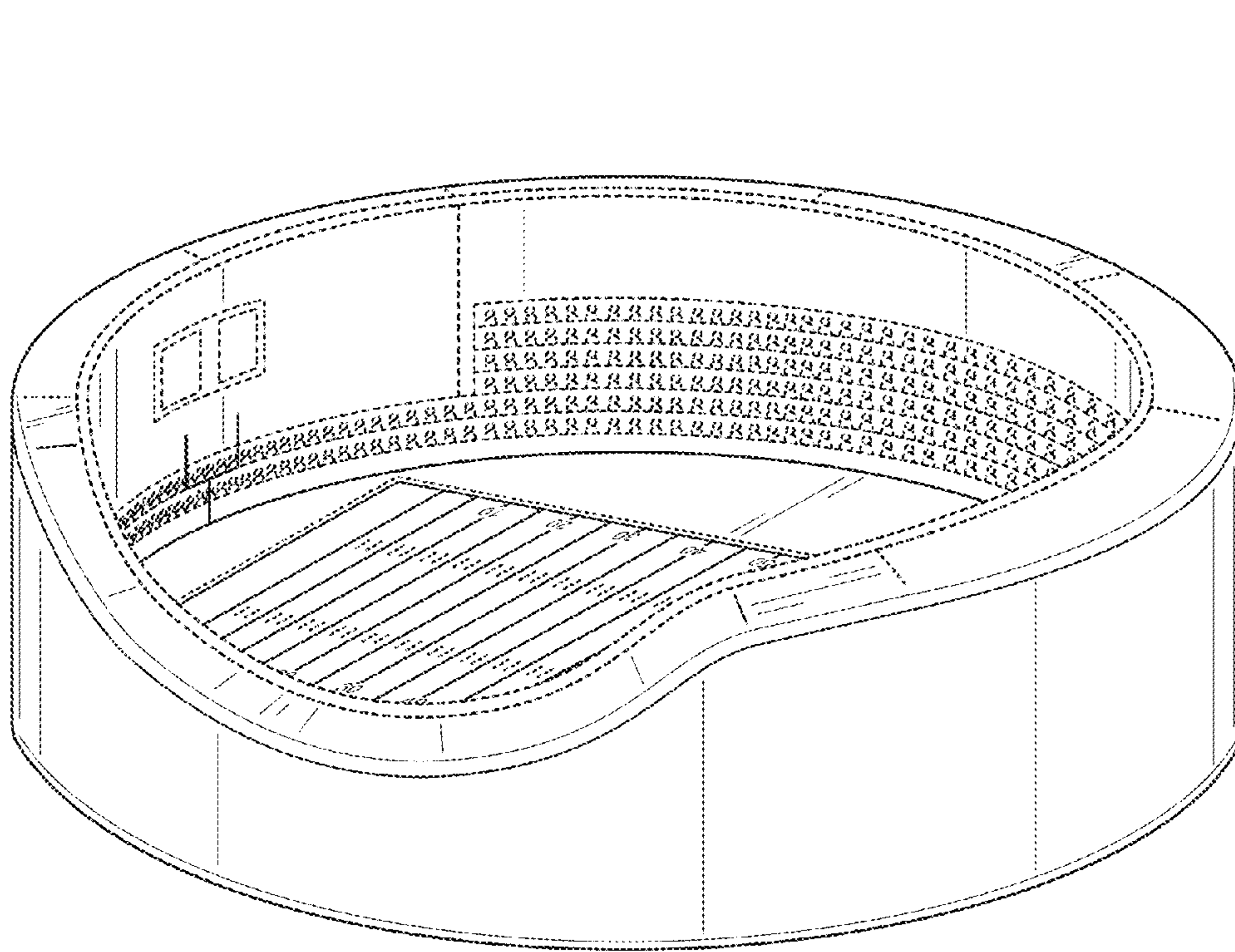

FIG. 1

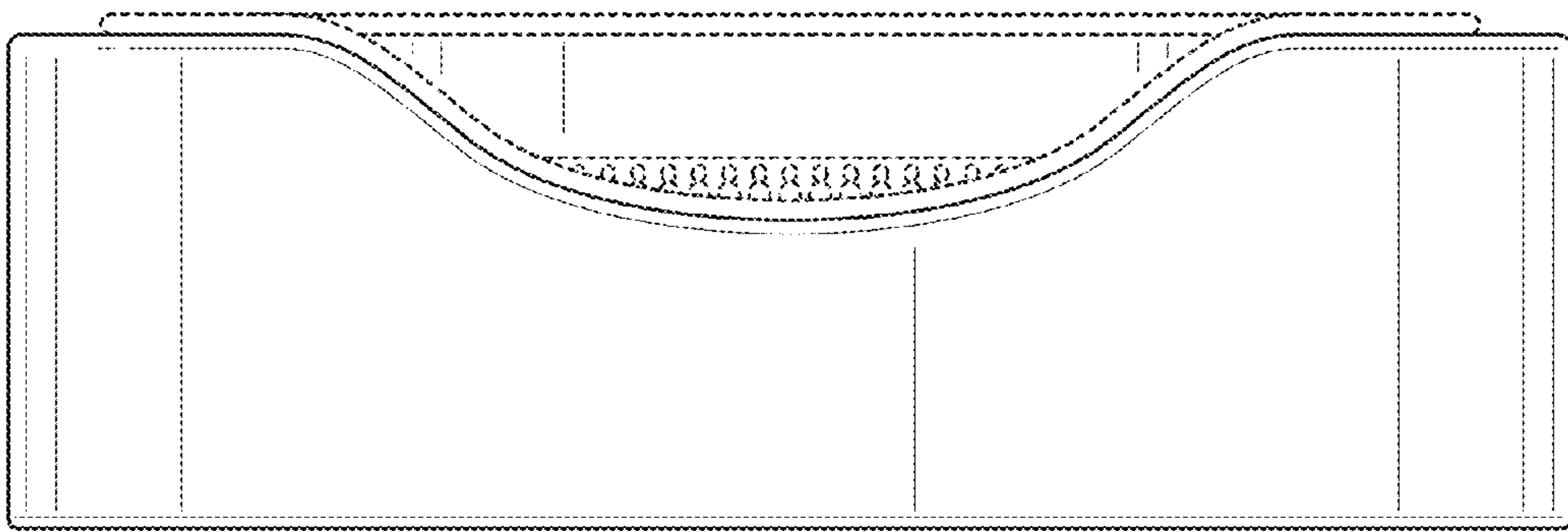

FIG. 2

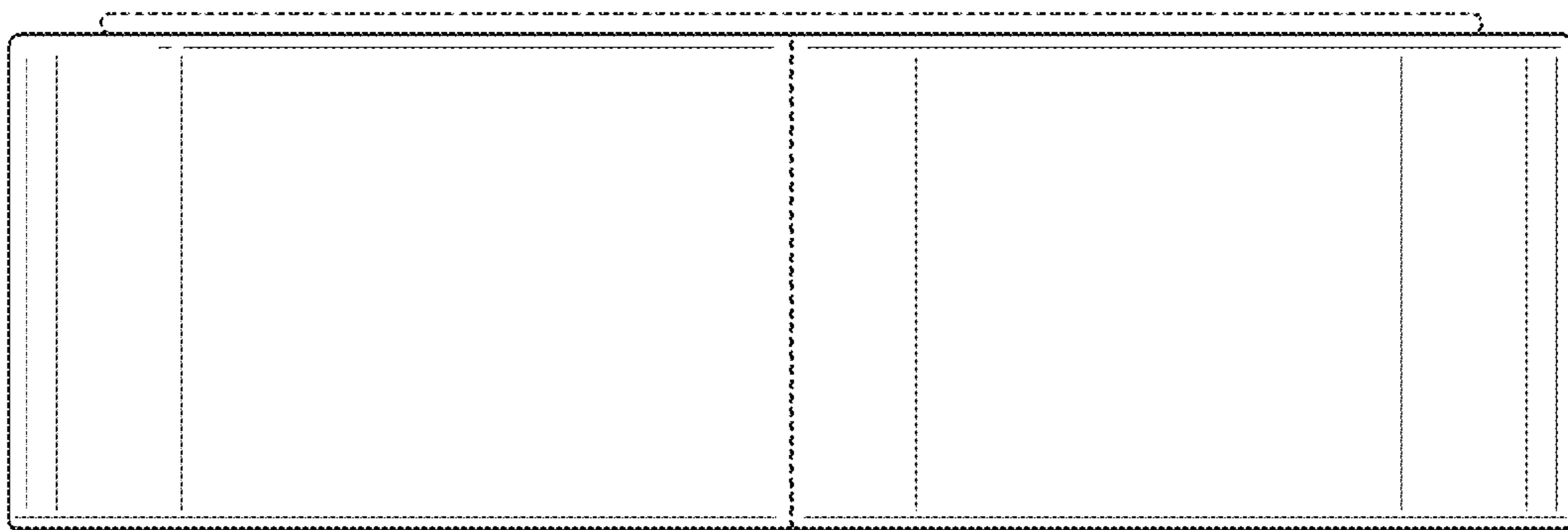

FIG. 3

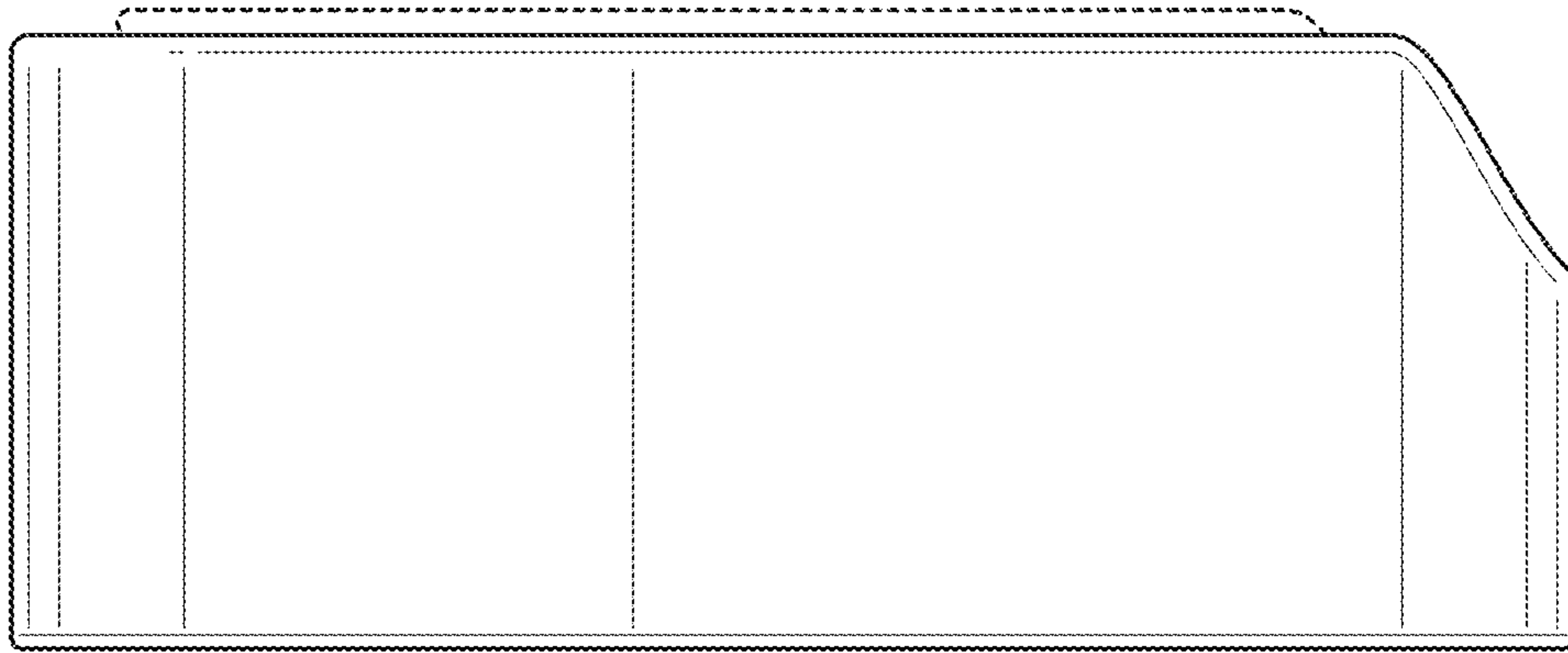

FIG. 4

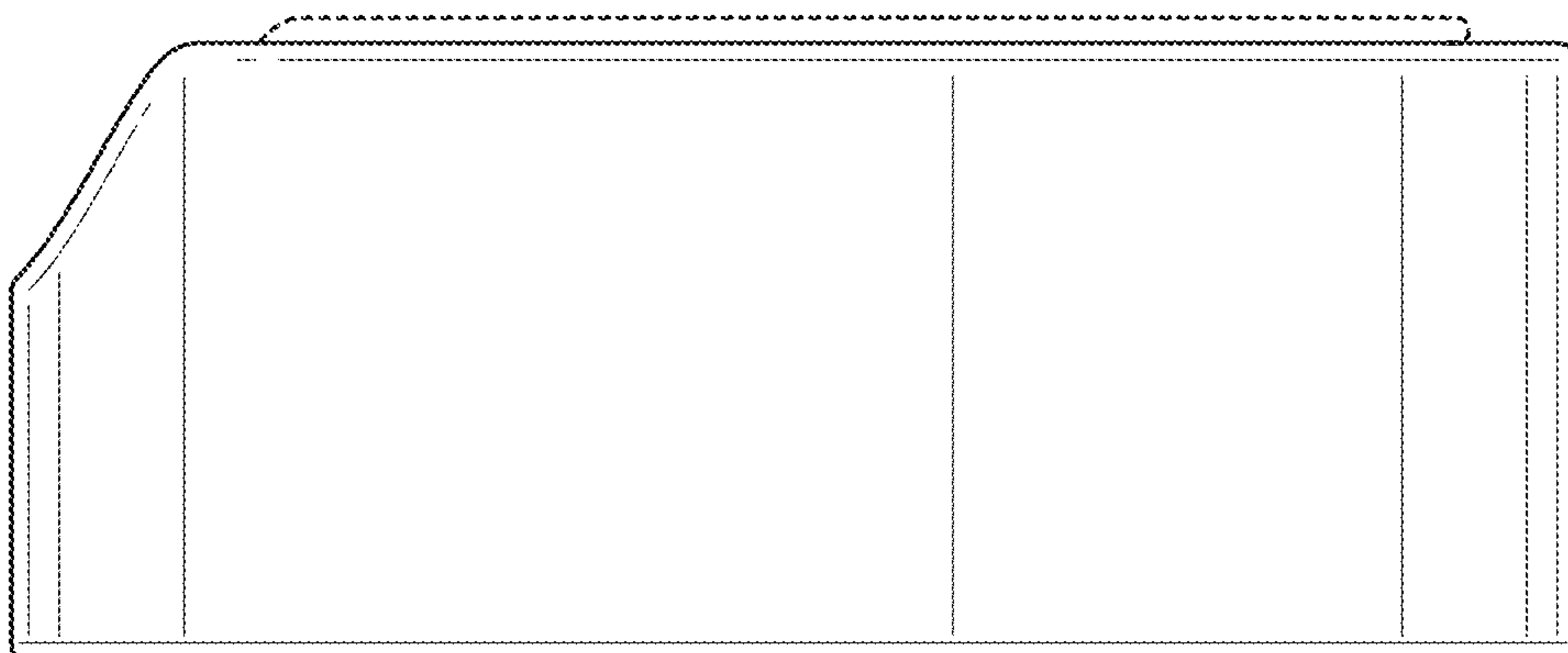

FIG. 5

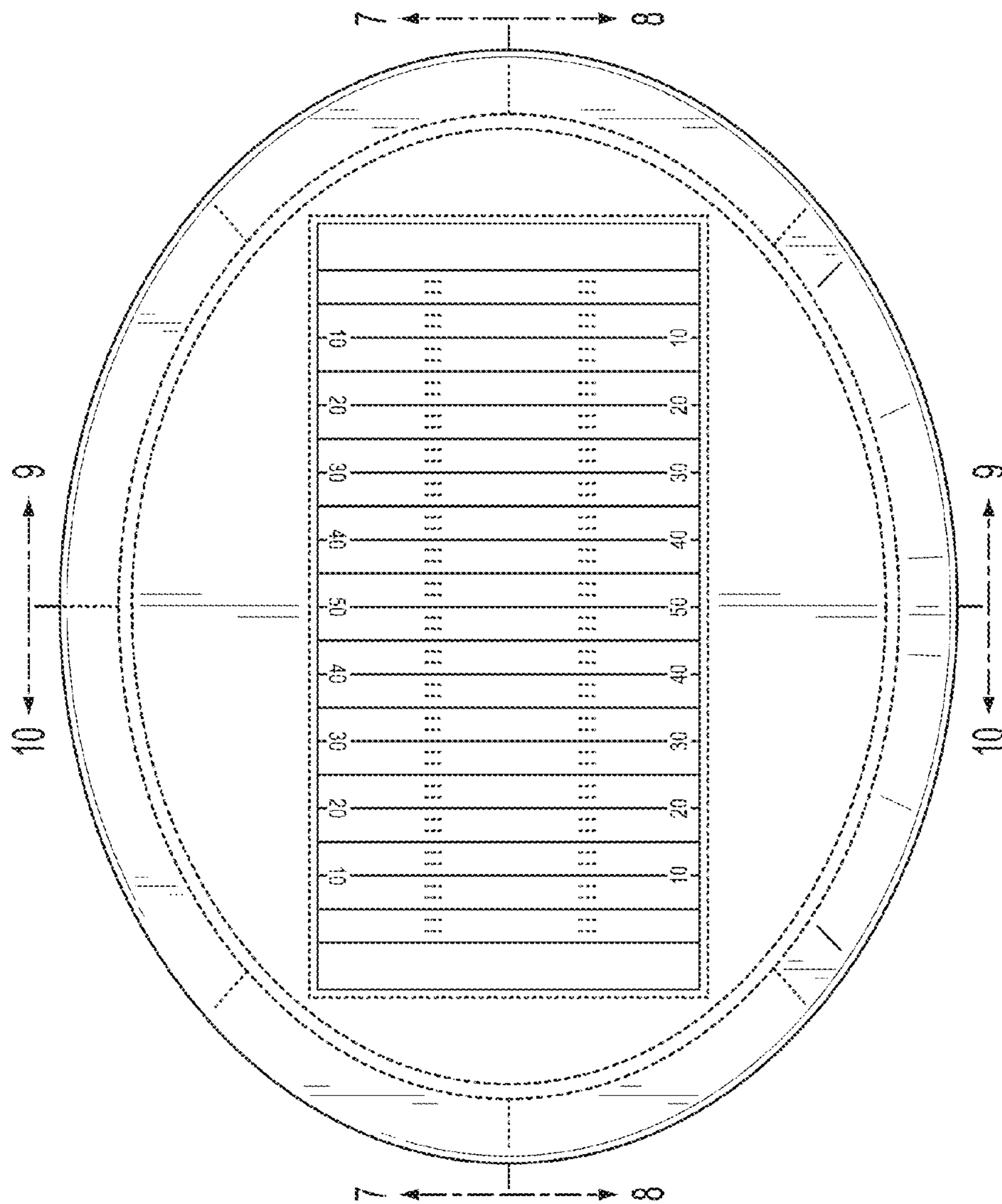

FIG. 6

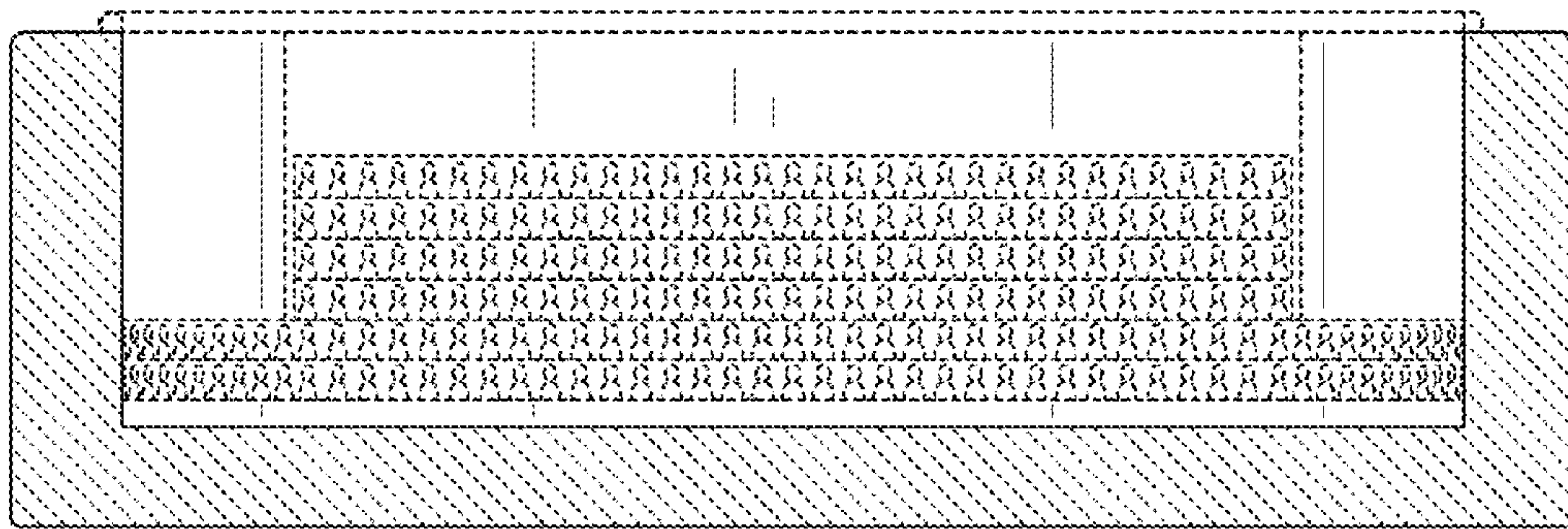

FIG. 7

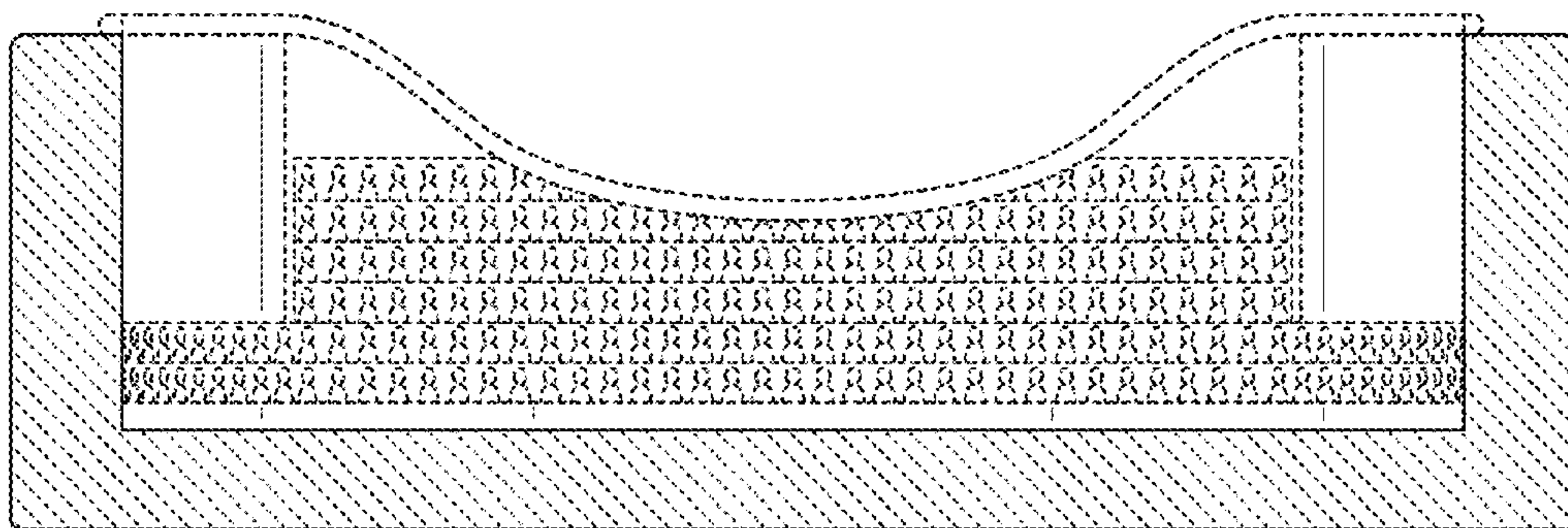

FIG. 8

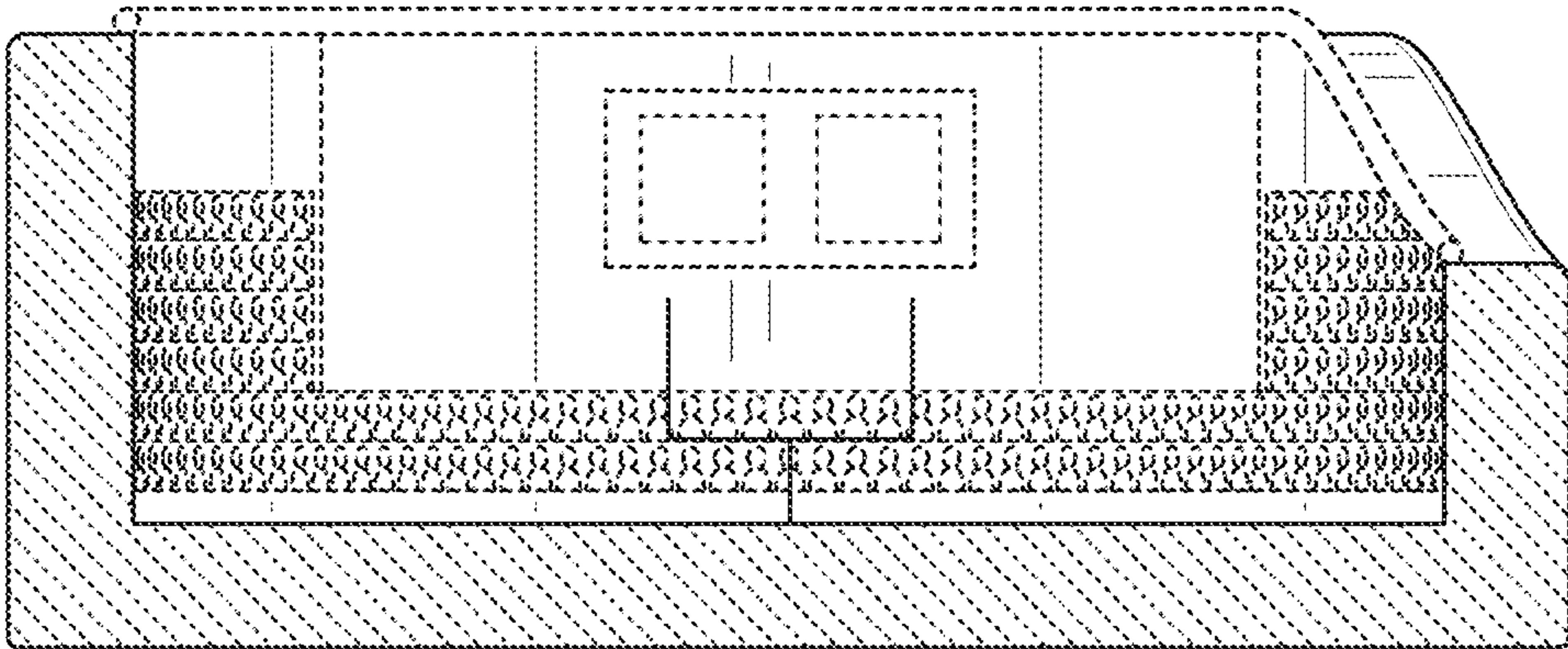

FIG. 9

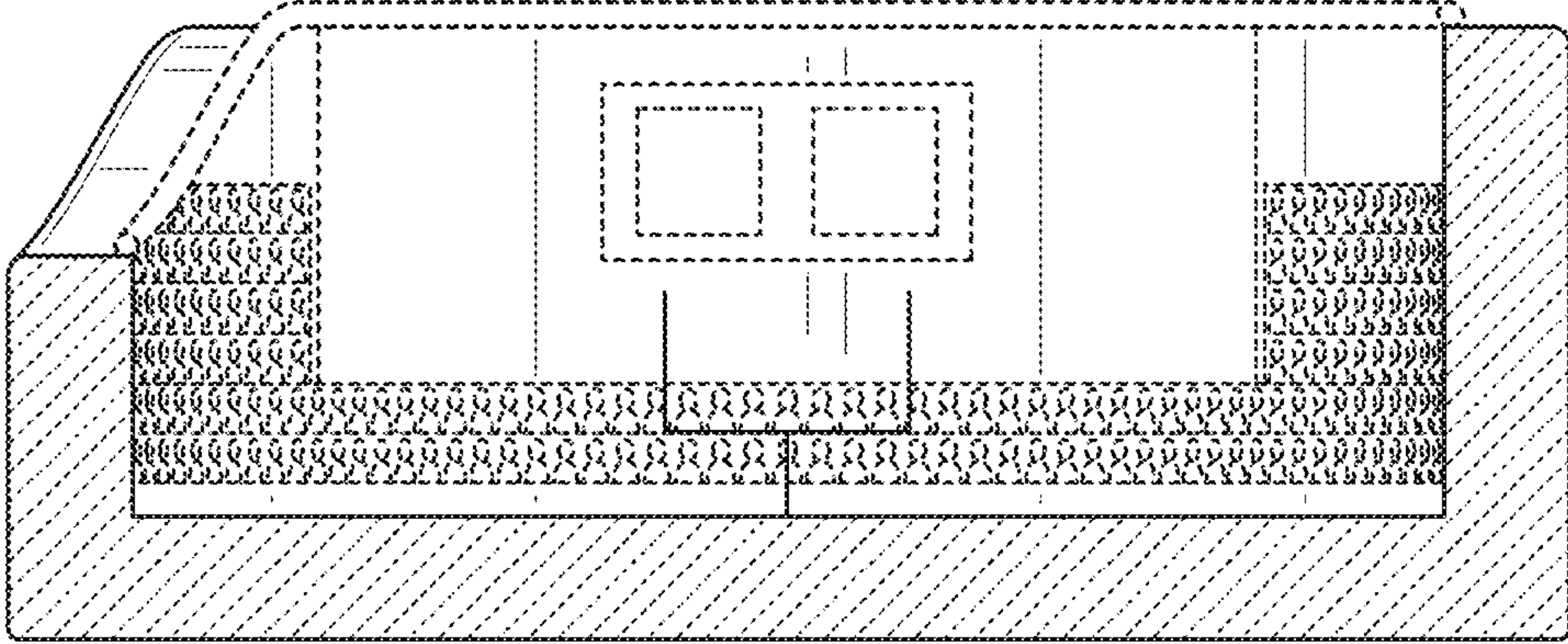

FIG. 10