



US00D740461S

(12) **United States Design Patent**
Decker

(10) **Patent No.:** **US D740,461 S**
(45) **Date of Patent:** **** Oct. 6, 2015**

(54) **CANDLE OR OIL LAMP HAVING A PLANAR OR BENT PLANAR WICK**

(71) Applicant: **LUMETIQUE, INC.**, Fountain Valley, CA (US)

(72) Inventor: **DayNa M. Decker**, Fountain Valley, CA (US)

(73) Assignee: **LUMETIQUE, INC.**, Fountain Valley, CA (US)

(**) Term: **14 Years**

(21) Appl. No.: **29/485,808**

(22) Filed: **Mar. 24, 2014**

Related U.S. Application Data

(60) Division of application No. 29/414,605, filed on Mar. 1, 2012, now Pat. No. Des. 705,459, which is a continuation-in-part of application No. 29/393,405, filed on Jun. 3, 2011, now Pat. No. Des. 678,558, which is a continuation of application No. 10/759,508, filed on Jan. 15, 2004, now Pat. No. 8,348,662, which is a continuation-in-part of application No. 10/300,695, filed on Nov. 19, 2002, now abandoned.

(51) **LOC (10) Cl.** **26-04**

(52) **U.S. Cl.**
USPC **D26/6**

(58) **Field of Classification Search**
USPC D26/4-10; 431/288-292
See application file for complete search history.

(56) **References Cited**

U.S. PATENT DOCUMENTS

59,839 A	11/1866	Hoard
123,917 A	2/1872	Ladd
170,158 A	11/1875	Cushing
197,902 A	12/1877	Scott
252,590 A	1/1882	Loper
275,293 A	4/1883	Tisdale
323,058 A	7/1885	Mitchell
383,822 A	5/1888	Munger

415,231 A	11/1889	Walters
431,033 A	7/1890	Chapin
436,509 A	9/1890	Walters
827,066 A	7/1906	Hafner
1,267,968 A	5/1918	Bulle
1,320,109 A	10/1919	Wooster
1,389,490 A	8/1921	Cook et al.
1,475,134 A	11/1923	Oakes
1,576,205 A	3/1926	Mertens
1,636,709 A	7/1927	Schmidt
1,657,391 A	1/1928	Haney
1,660,760 A	2/1928	Murphy
1,756,885 A	4/1930	Schafer
1,831,902 A	11/1931	Brown
1,841,690 A	1/1932	Weindel, Jr.
1,961,920 A	6/1934	Arpin
2,015,383 A	9/1935	Konig et al.
2,107,054 A	2/1938	Haymond
D111,775 S	* 10/1938	Seaver D26/6
2,168,698 A	8/1939	Bunt et al.
2,241,167 A	5/1941	Storck
2,324,753 A	7/1943	Alexiade
2,373,512 A	4/1945	Starner
2,464,361 A	3/1949	Wilson
D178,200 S	7/1956	McKenzie et al.
2,758,460 A	8/1956	Ciano
2,809,512 A	10/1957	Hartnett
3,039,283 A	6/1962	Buscemi
3,086,658 A	4/1963	Palmer
3,175,876 A	3/1965	Fredericks
3,269,807 A	8/1966	Hobart, Jr.
3,286,492 A	11/1966	Frazier, Jr.
3,367,758 A	2/1968	Ambrose et al.
3,380,797 A	4/1968	Summers
3,428,409 A	2/1969	Summers
3,462,235 A	8/1969	Summers
3,466,135 A	9/1969	Summers
3,495,924 A	2/1970	Leonard et al.
3,560,122 A	2/1971	Cassar
3,637,335 A	1/1972	Uhl
3,652,197 A	3/1972	Tokarz
3,706,523 A	12/1972	Kumm
3,759,478 A	9/1973	Schmitt et al.
3,761,702 A	9/1973	Andeweg
3,883,143 A	5/1975	Kelley et al.
3,998,922 A	12/1976	Weiss
4,304,547 A	12/1981	Buzil
4,381,914 A	5/1983	Ferguson
4,477,249 A	10/1984	Ruzek et al.
4,557,687 A	12/1985	Schirneker
4,568,269 A	2/1986	Lin
4,568,270 A	2/1986	Marcus et al.
4,682,947 A	7/1987	Luken, Jr.

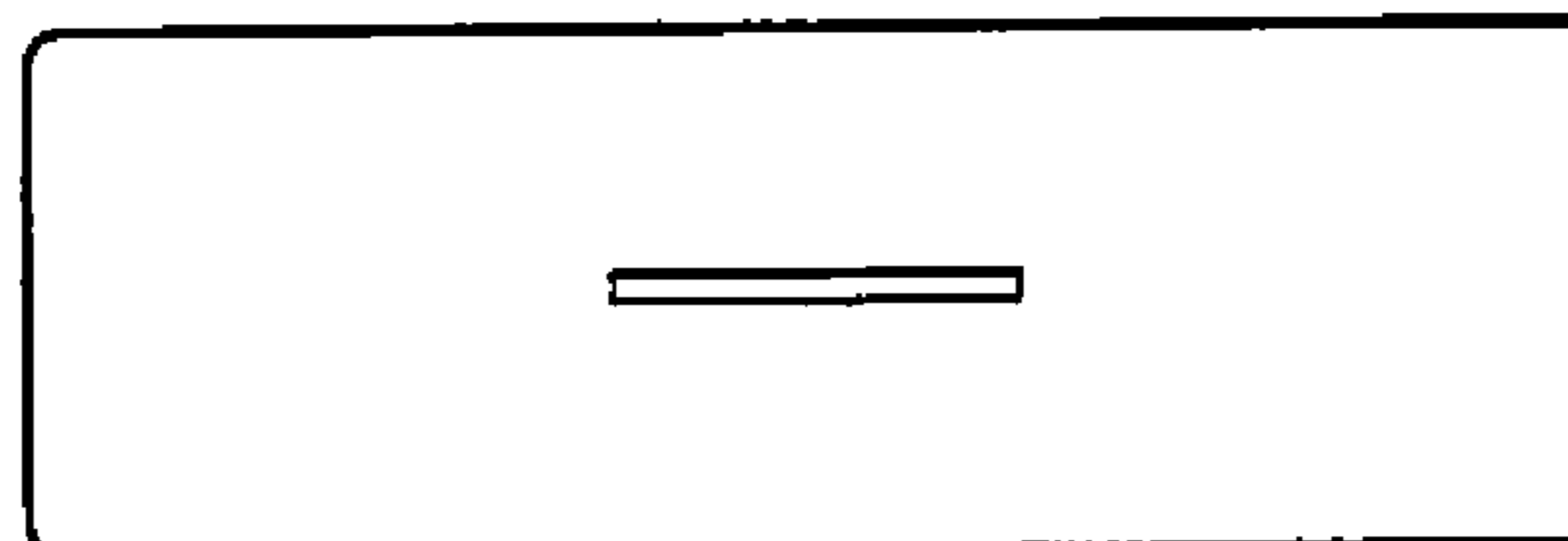
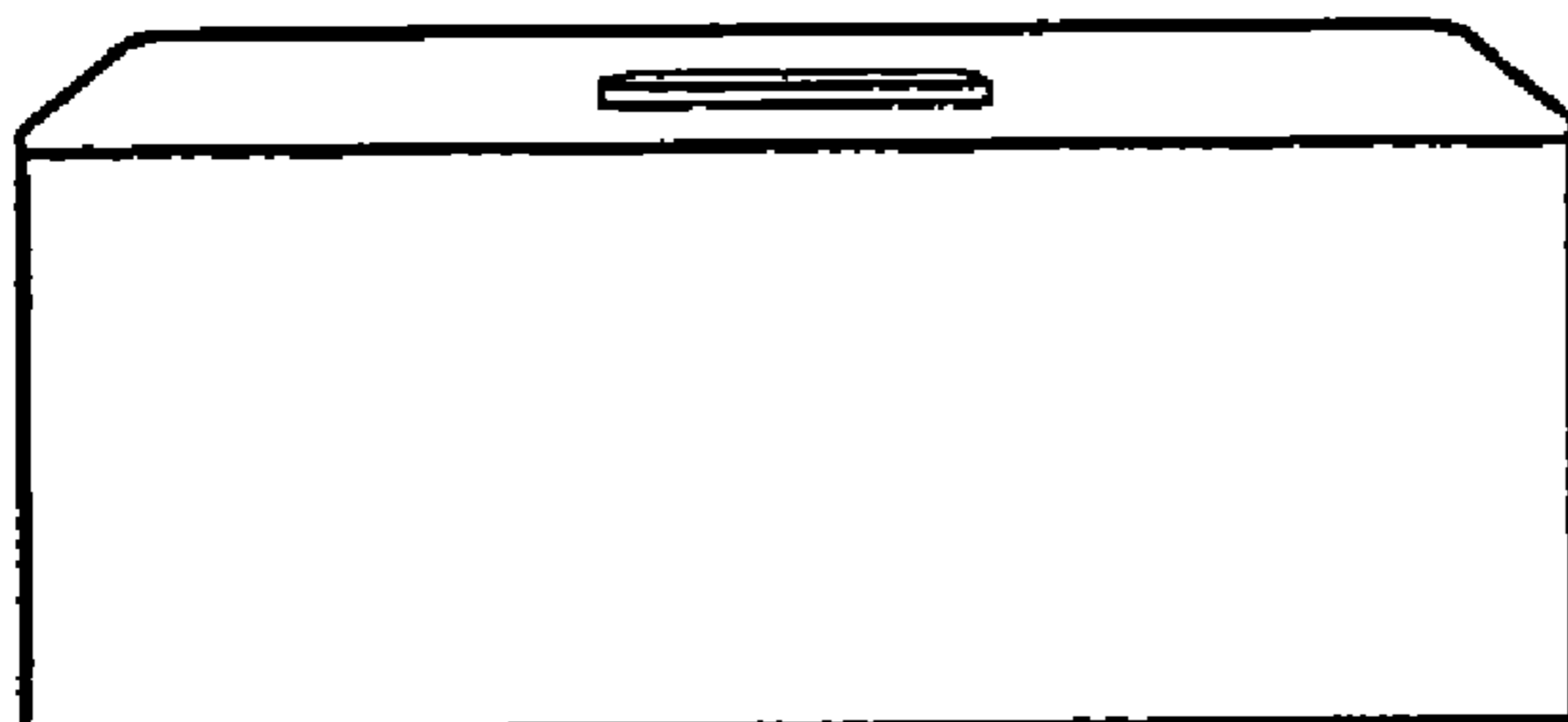

4,696,640	A	9/1987	Pitchford	
4,725,286	A	2/1988	Brame	
4,804,323	A	2/1989	Kim	
4,839,144	A	6/1989	Martin	
4,855,098	A	8/1989	Taylor	
4,917,597	A	4/1990	Henze	
5,015,175	A	5/1991	Lee	
5,069,617	A	12/1991	Lin	
D350,566	S	9/1994	Pearson	
5,363,590	A	11/1994	Lee	
5,487,658	A	1/1996	Lee	
5,597,300	A	1/1997	Wohl et al.	
5,683,239	A	11/1997	Cardosi	
5,683,762	A	11/1997	Banschick	
5,690,484	A	11/1997	Leonard et al.	
5,772,424	A	6/1998	Nokelainen	
D397,459	S	8/1998	Hsu	
5,807,096	A	9/1998	Shin et al.	
5,830,245	A	11/1998	Raddon	
5,846,070	A	12/1998	Kim et al.	
5,879,153	A	3/1999	Slejertin	
5,967,769	A	10/1999	Thompson	
6,017,373	A	1/2000	Frisch	
6,033,210	A	3/2000	Freeman	
6,063,144	A	5/2000	Calzada et al.	
6,068,472	A	5/2000	Freeman et al.	
6,074,199	A	6/2000	Song	
6,076,515	A	6/2000	Smith	
6,129,771	A	10/2000	Ficke	
6,214,295	B1	4/2001	Freeman	
6,241,512	B1	6/2001	Freeman et al.	
6,276,925	B1	8/2001	Varga	
D456,537	S	4/2002	Leeds	
D458,394	S	6/2002	Leeds	
D459,498	S	6/2002	Araujo	
6,409,501	B1	6/2002	Pappas	
6,419,713	B1	7/2002	Durand et al.	
6,440,184	B2	8/2002	Noda et al.	
6,454,561	B1	9/2002	Colthar et al.	
6,471,899	B2	10/2002	Daiber et al.	
D466,632	S	12/2002	Lablaine	
6,508,644	B1	1/2003	Pesu et al.	
6,554,448	B2	4/2003	Carpenter	
6,568,934	B1	5/2003	Butler	
D481,142	S	10/2003	Leeds	
6,783,356	B2	8/2004	Hermanson	
D496,474	S	9/2004	Murdick	
6,793,484	B2	9/2004	Pesu et al.	
6,793,697	B2	9/2004	Sprules et al.	
6,823,780	B2	11/2004	Vogt et al.	
6,863,525	B2	3/2005	Byrd	
D590,078	S	4/2009	Horezniak et al.	
7,568,913	B2	8/2009	Decker et al.	
D637,741	S	5/2011	Horezniak et al.	
D643,554	S	8/2011	Decker	
D644,359	S *	8/2011	Decker	D26/6
D644,360	S	8/2011	Decker	
2001/0029003	A1	10/2001	Zou	
2001/0043469	A1	11/2001	Carpenter et al.	
2002/0018976	A1	2/2002	Zou	
2002/0022205	A1	2/2002	Elliott et al.	
2003/0036028	A1	2/2003	Pesu et al.	
2004/0029061	A1	2/2004	Dibnah et al.	
2004/0033463	A1	2/2004	Pesu et al.	
2005/0037308	A1	2/2005	Decker	
2008/0153046	A1	6/2008	Delcotto et al.	
2011/0024945	A1	2/2011	Decker	
2011/0027735	A1	2/2011	Decker	
2011/0027736	A1	2/2011	Decker	
2011/0027737	A1	2/2011	Decker	
2012/0064467	A1	3/2012	Delcotto et al.	
2012/0129114	A1	5/2012	Barresi	
2012/0148966	A1	6/2012	Ramaker et al.	
2012/0202160	A1	8/2012	Ford	
2012/0225392	A1	9/2012	Decker	
2012/0264069	A1	10/2012	Ramirez	
2013/0095440	A1	4/2013	Cagle et al.	
2013/0112346	A1	5/2013	Cagle et al.	

FOREIGN PATENT DOCUMENTS

EP	1245663	10/2002
FR	2639356	5/1990
FR	2811676	1/2002

OTHER PUBLICATIONS

Firewood for Your Fireplace: Warren Donnelly; 10/194, pp. 18, 25, 34, 35, 37, 84, 85, 88-95.
 Swedish Patent No. 9903818; English language translation; Gunnar Ebelling; May 2, 2000; pp. 1a-7.
 www.CLARLUSPP.com/candles/index.php, "Waxes: Candles." Internet printout on Jul. 6, 2006, 1 page.
 www.WESTESTIT.com/wax.htm, "Wax." Internet printout on Jul. 6, 2006, 3 pages.
 Improvements Catalog, [online], (Retrieved on Jan. 11, 2005), Retried from the Internet: <http://www.improvementscatalog.com/Parent.asp?product=240717x&dept%5Fid=300&subdept%5Fid=304>.
 World Flame Catalog, [online], (Retrieved on Jan. 11, 2005), Retrieved from the Internet: <http://www.golighttheworld.com/Store/ProductJCategoryInfo.aspx?cid=7>.
 World Flame Catalog, [online], (Retrieved on Jan. 11, 2005), Retrieved from the Internet: <http://www.golighttheworld.com/Store/Product/CategoryInfo.aspx?cid=17>.
 Norma Coney, 2000, Lark Books, Deborah Morgenthal, pp. 16, 49-50 and 55-58.

* cited by examiner

Primary Examiner — Marcus Jackson
 (74) *Attorney, Agent, or Firm* — Oblon, McClelland, Maier & Neustadt, L.L.P.

(57) **CLAIM**

The ornamental designs for a candle or oil lamp having a planar or bent planar wick, as shown and described.

DESCRIPTION

FIG. 1 is a perspective view of a first embodiment of the candle or oil lamp having a planar or bent planar wick;
 FIG. 2 is a perspective view of a second embodiment of the candle or oil lamp having a planar or bent planar wick;
 FIG. 3 is top plan view thereof of the first and second embodiments of the candle or oil lamp having a planar or bent planar wick;
 FIG. 4 is a side perspective view of the first embodiment of the candle or oil lamp having a planar or bent planar wick;
 FIG. 5 is a side perspective view of the second embodiment of the candle or oil lamp having a planar or bent planar wick;
 FIG. 6 is a perspective view of a third embodiment of the candle or oil lamp having a planar or bent planar wick;
 FIG. 7 is a perspective view of a fourth embodiment of the candle or oil lamp having a planar or bent planar wick;
 FIG. 8 is top plan view thereof of the third and fourth embodiments of the candle or oil lamp having a planar or bent planar wick;
 FIG. 9 is a side perspective view of the third embodiment of the candle or oil lamp having a planar or bent planar wick;
 FIG. 10 is a side perspective view of the fourth embodiment of the candle or oil lamp having a planar or bent planar wick;
 FIG. 11 is a perspective view of a fifth embodiment of the candle or oil lamp having a planar or bent planar wick;
 FIG. 12 is a perspective view of a sixth embodiment of the candle or oil lamp having a planar or bent planar wick;

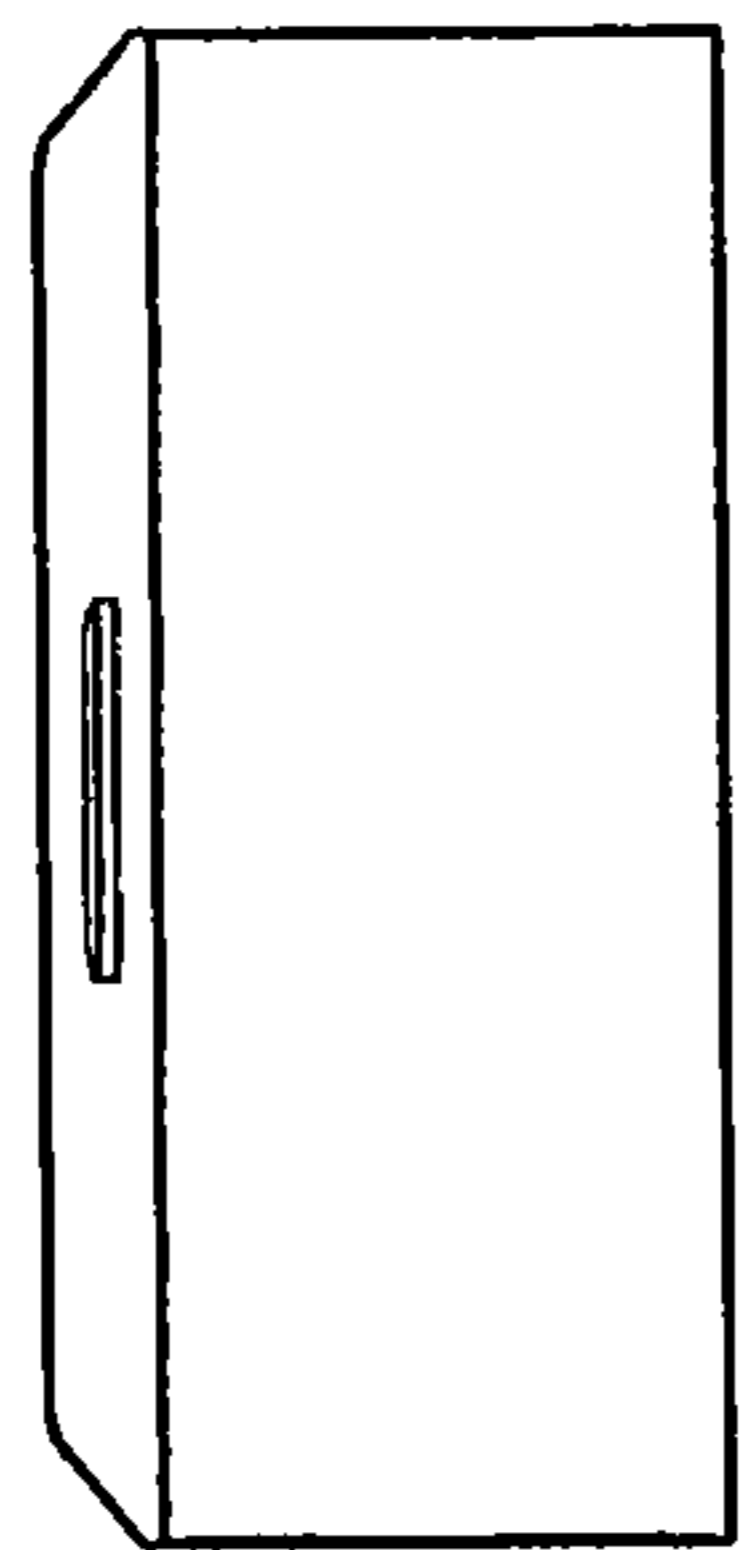

Fig. 1

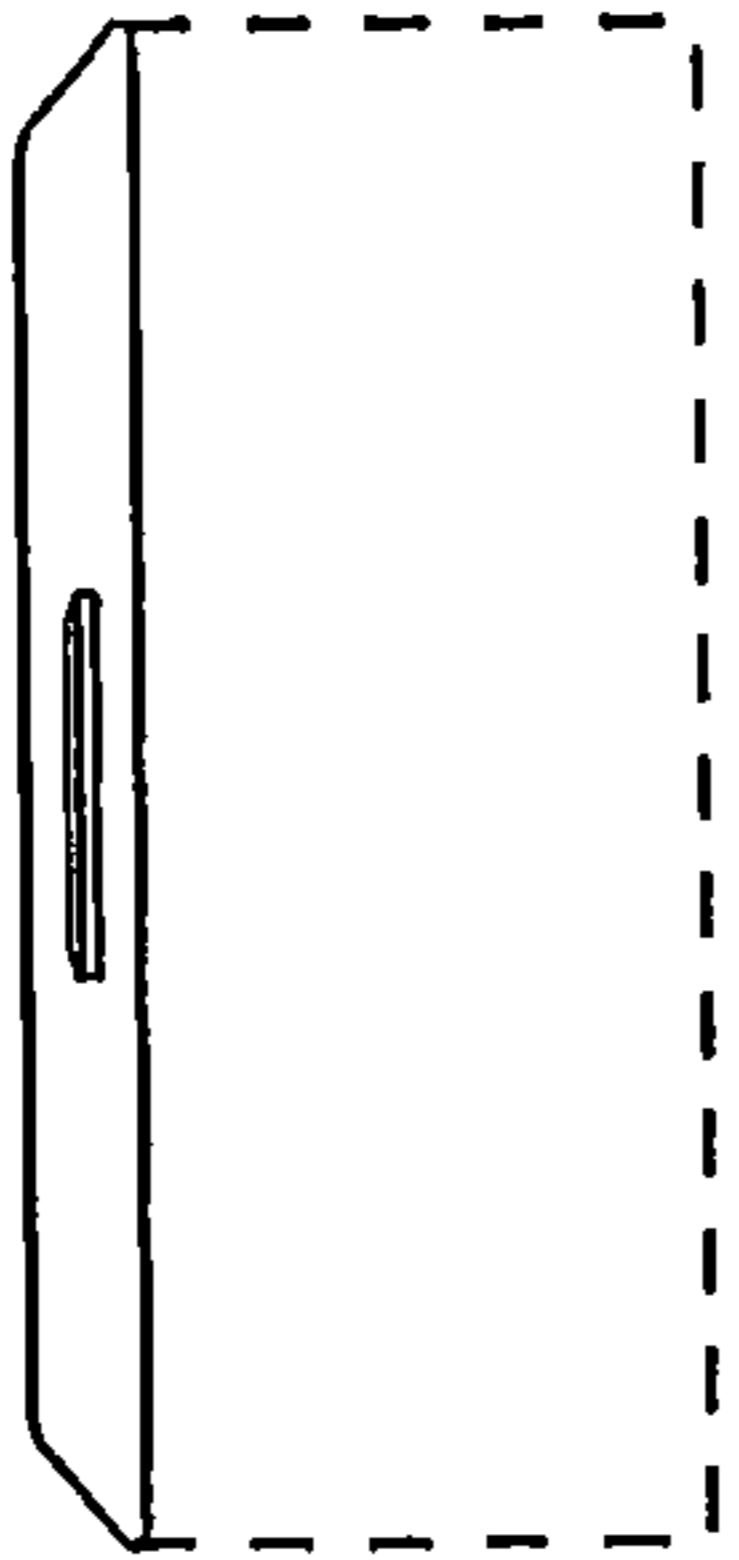

Fig. 2

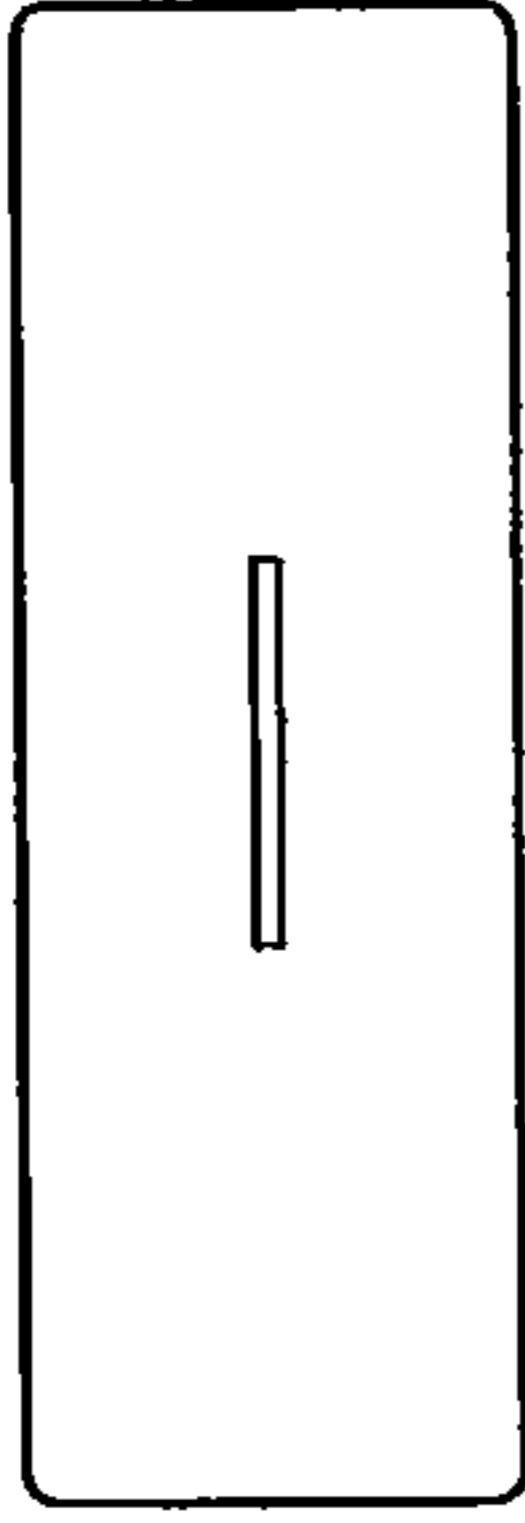

Fig. 3

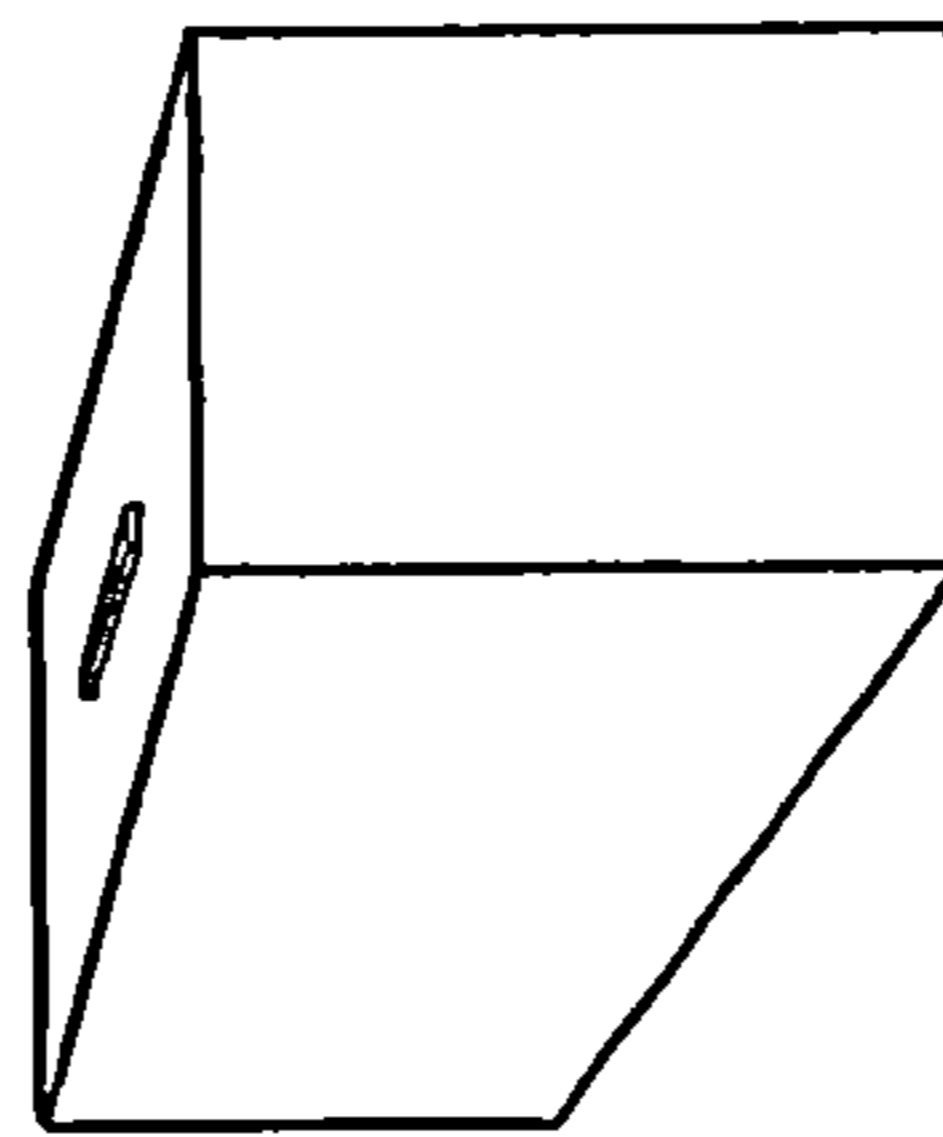

Fig. 4

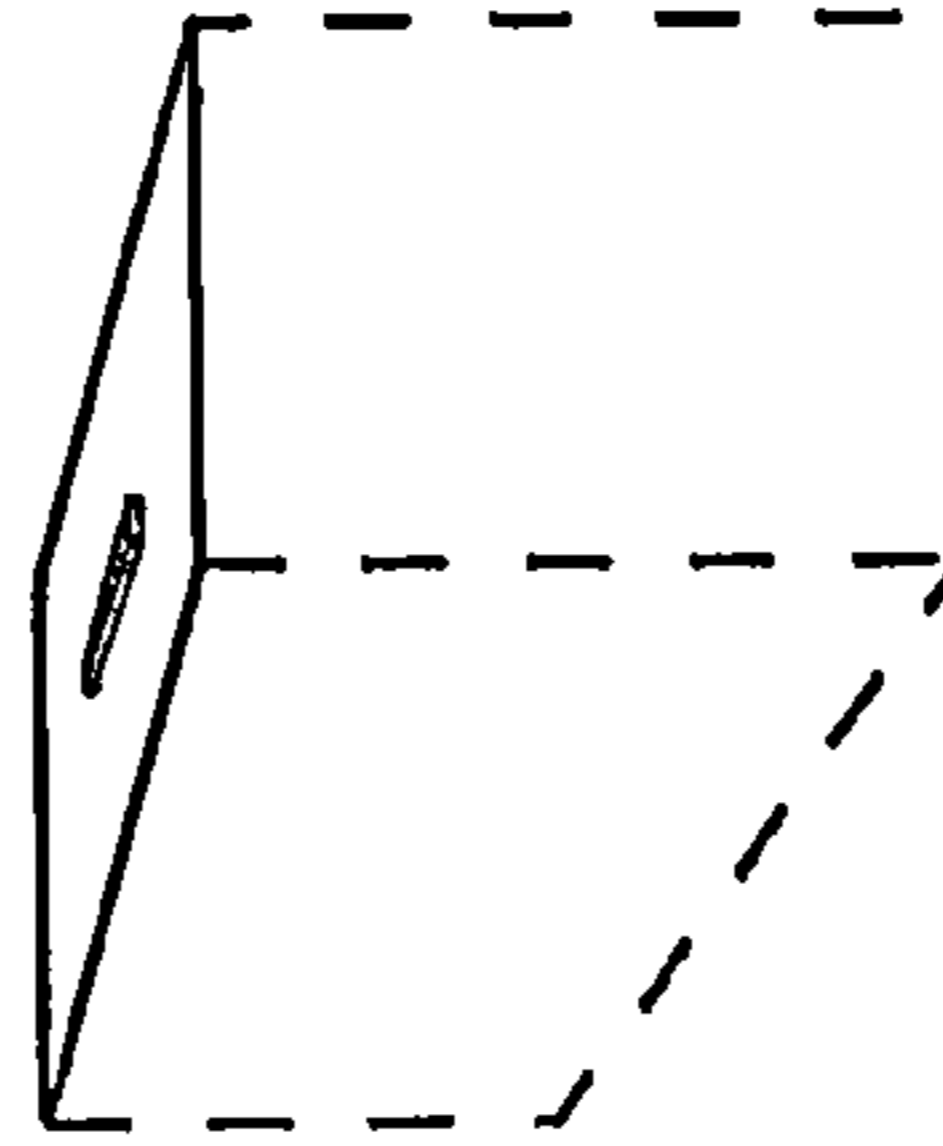

Fig. 5

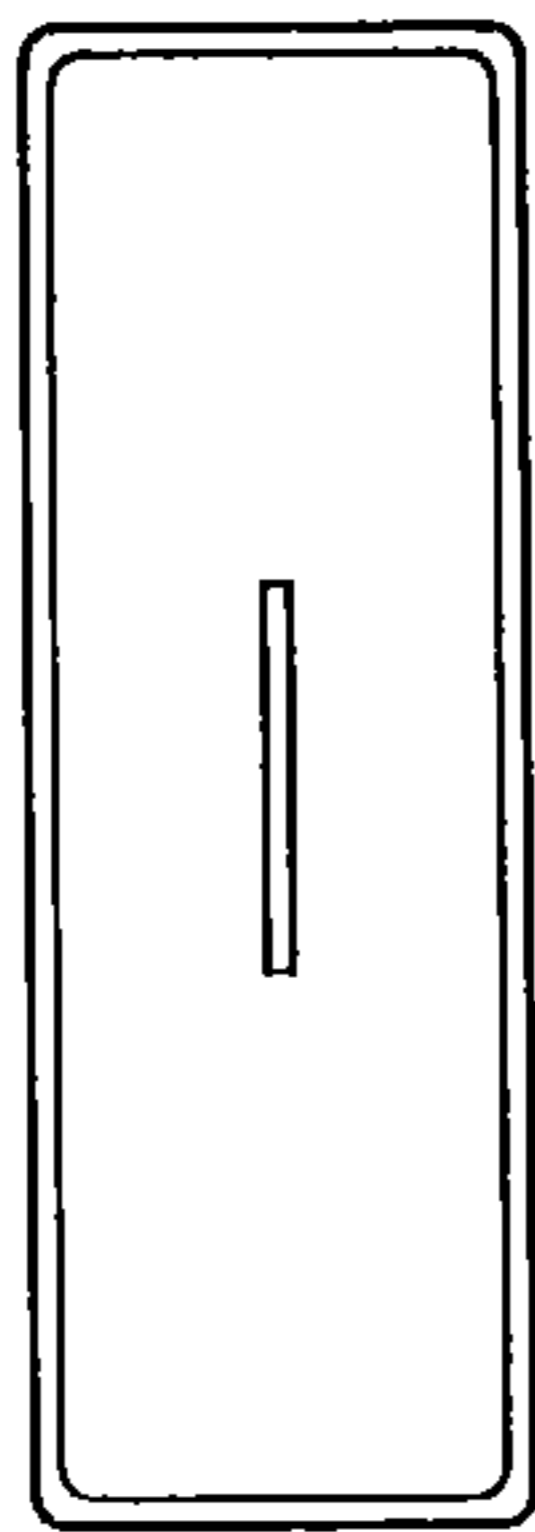

Fig. 8

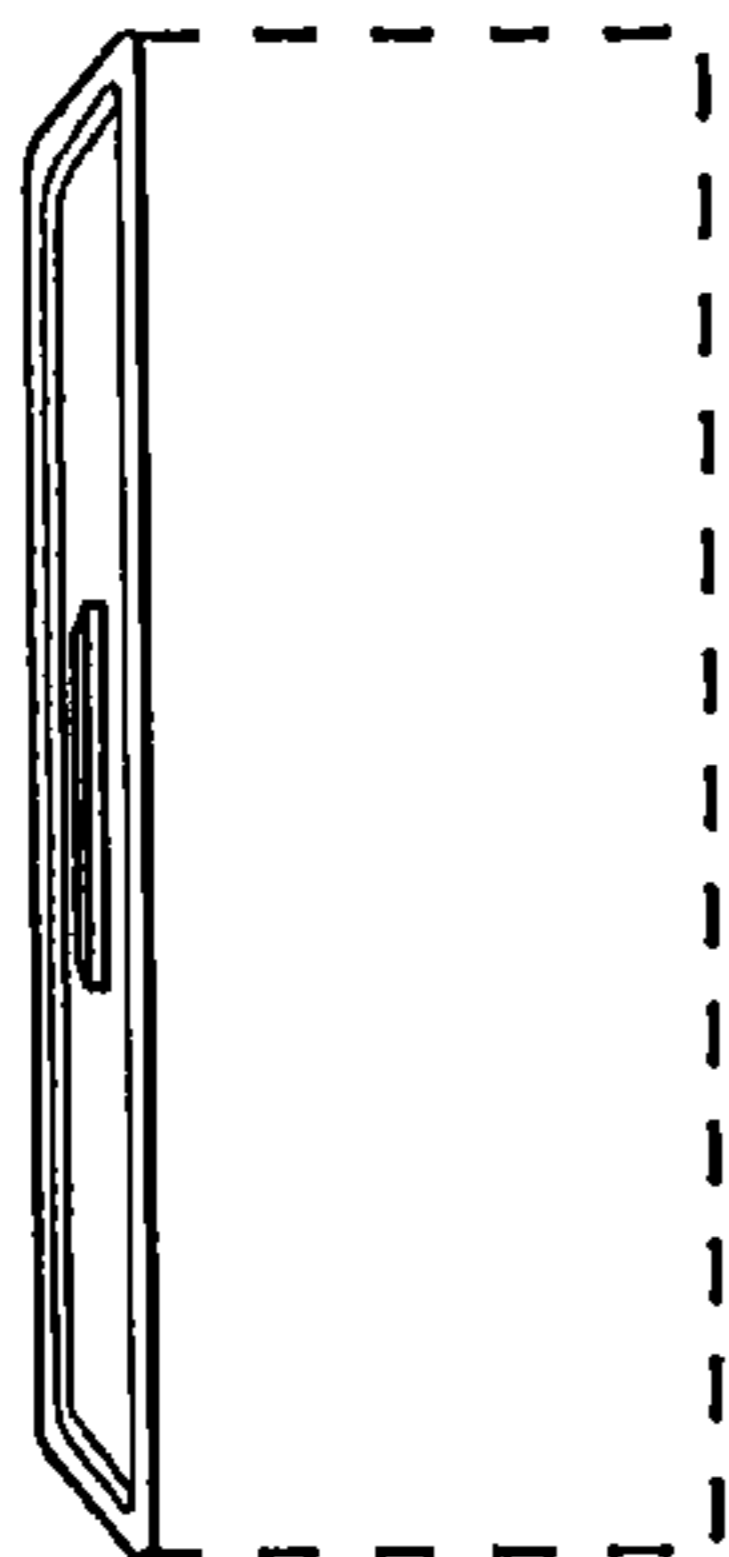

Fig. 7

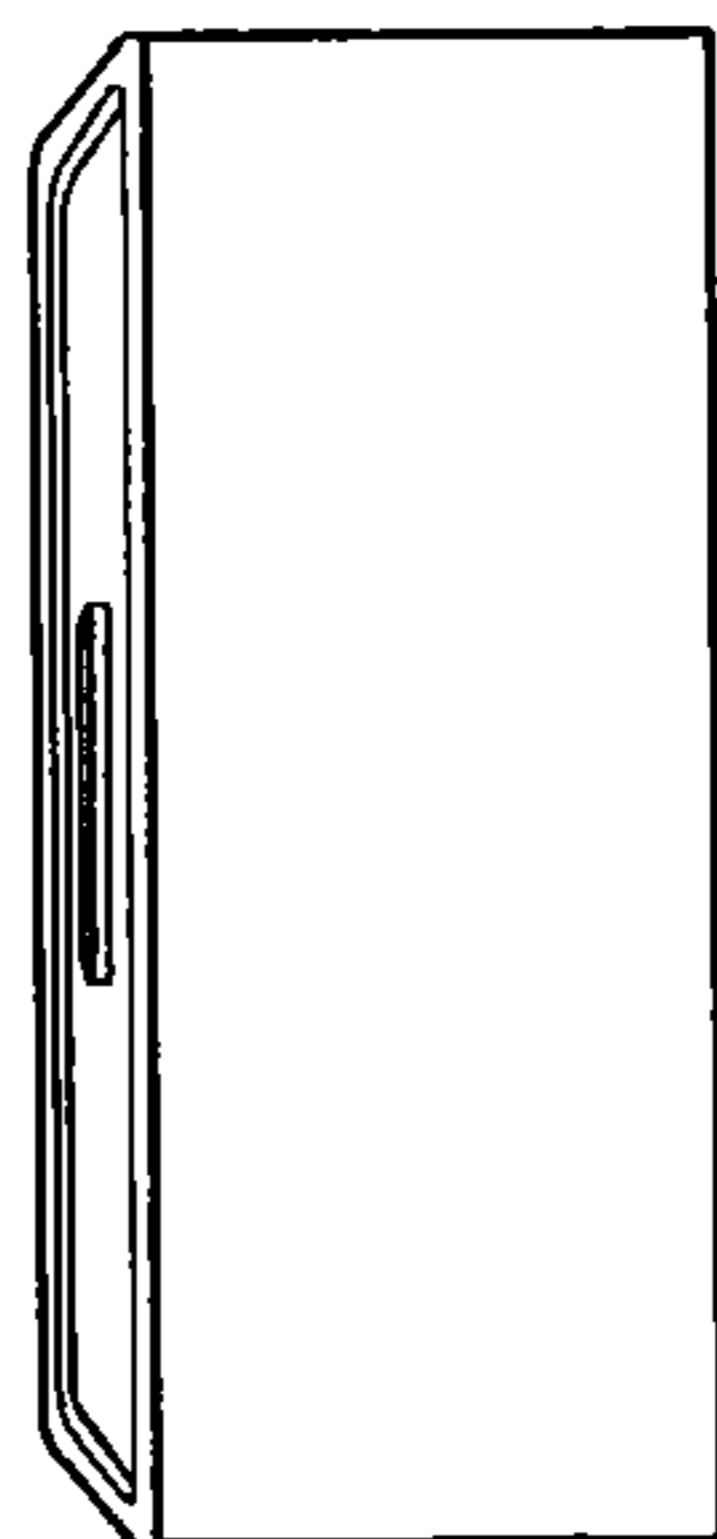

Fig. 6

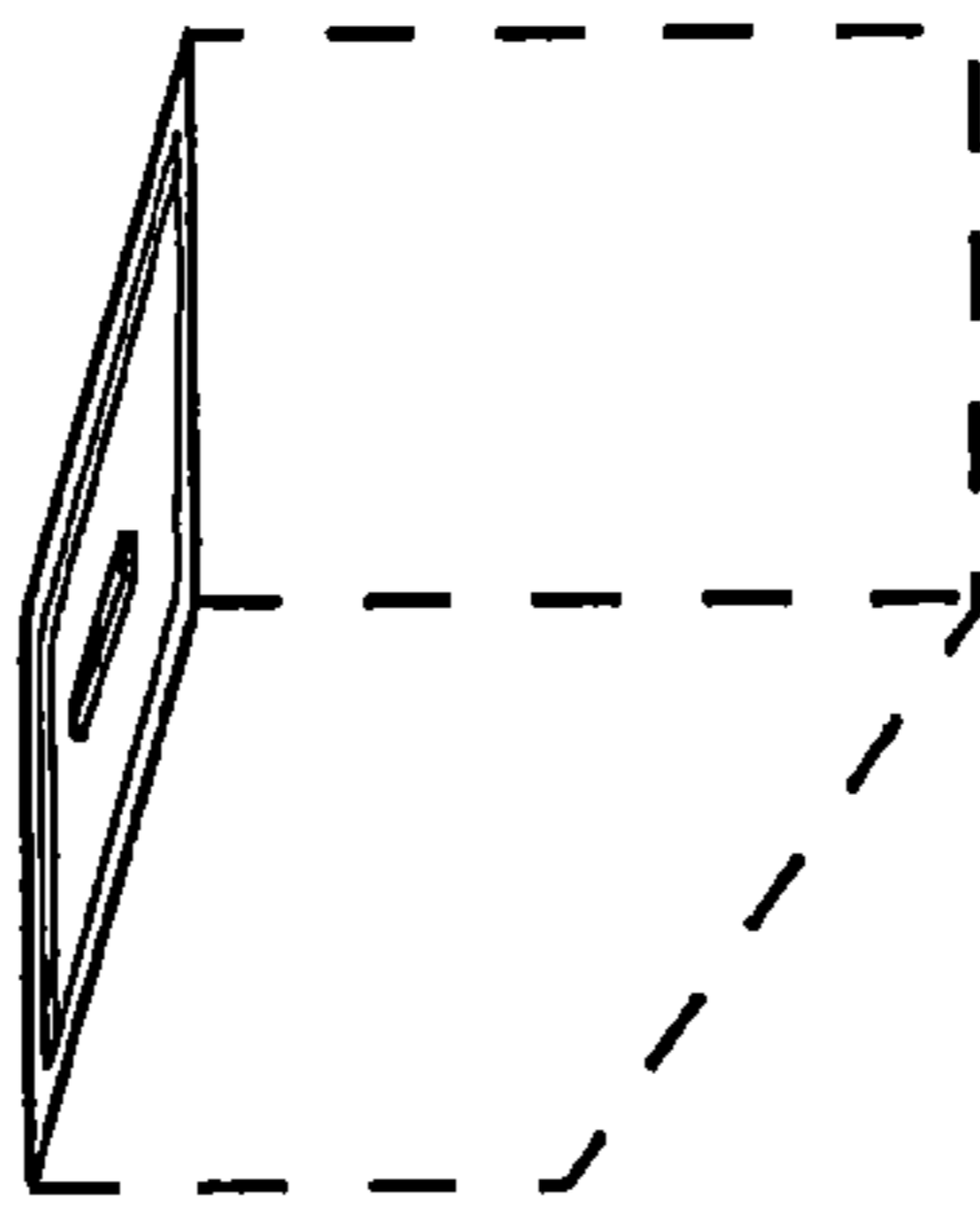

Fig. 10

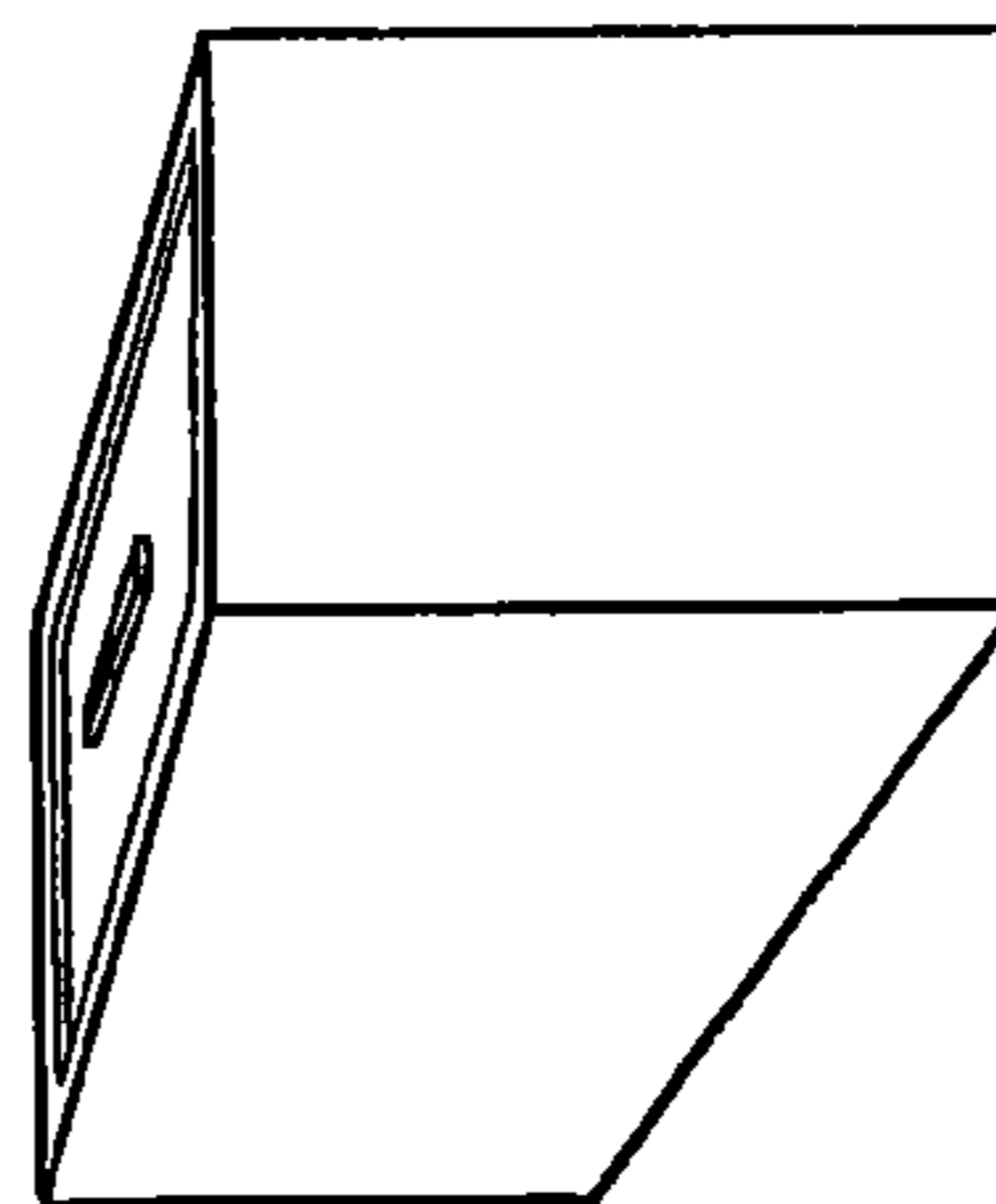

Fig. 9

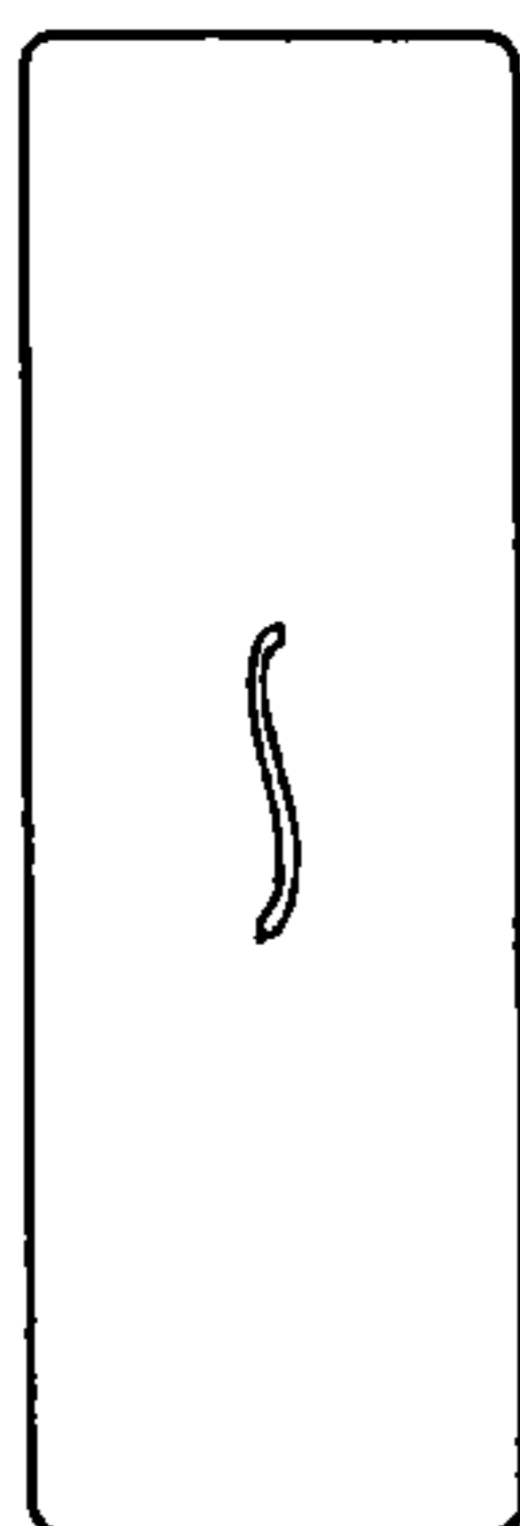

Fig. 13

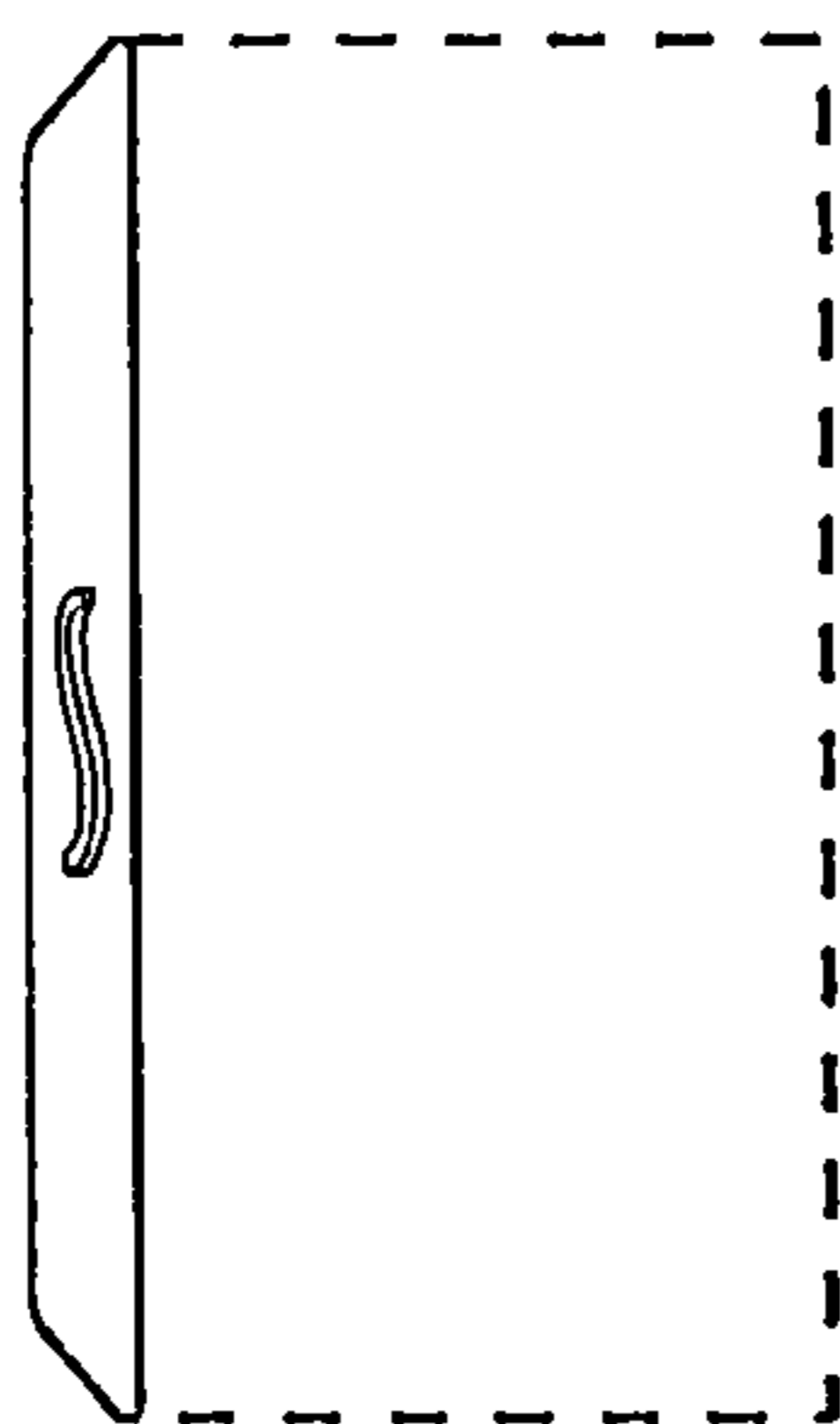

Fig. 12

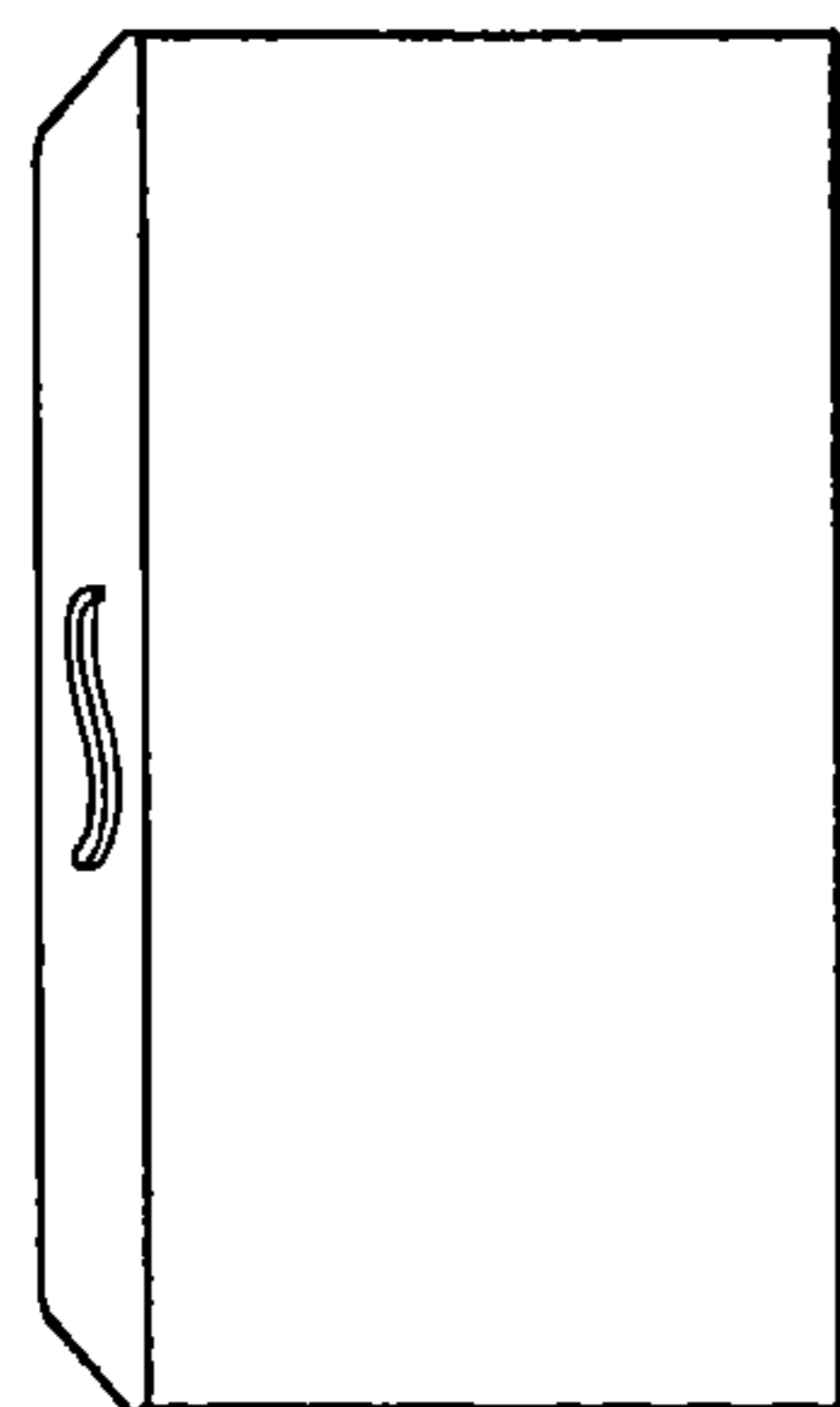

Fig. 11

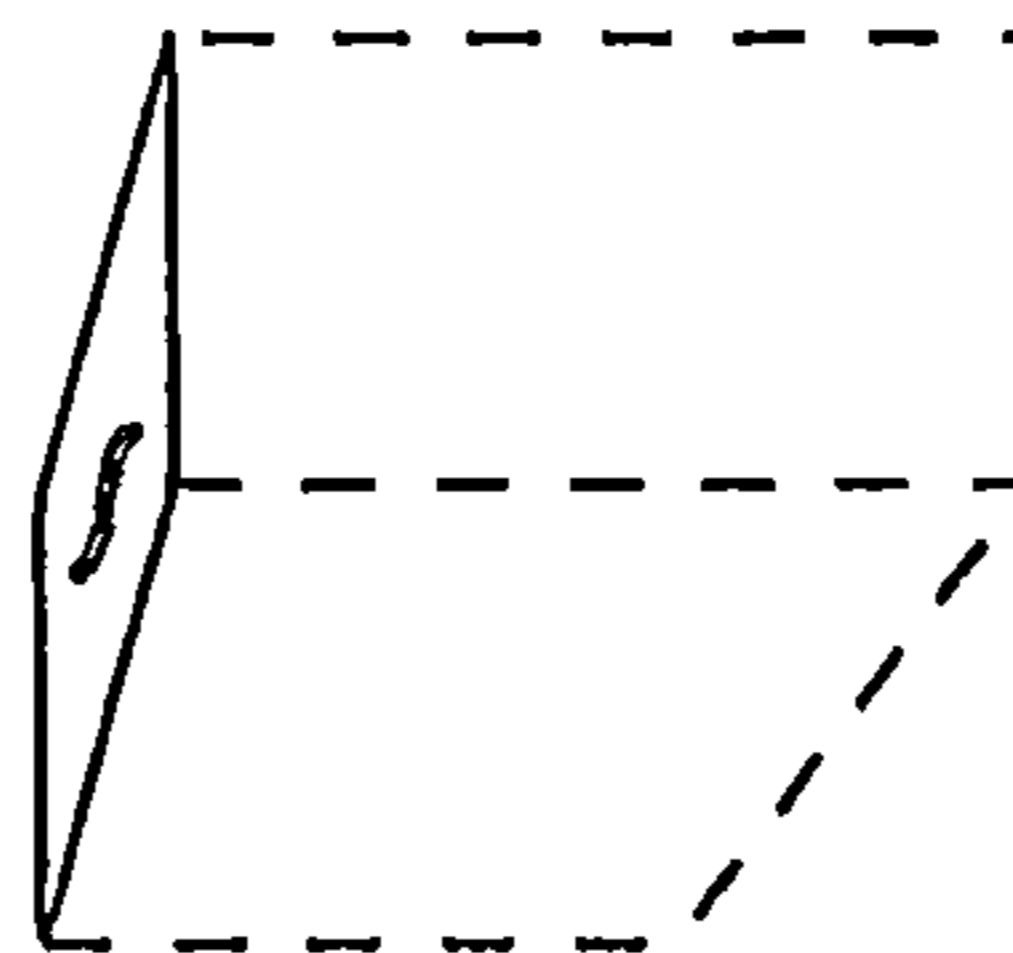

Fig. 15

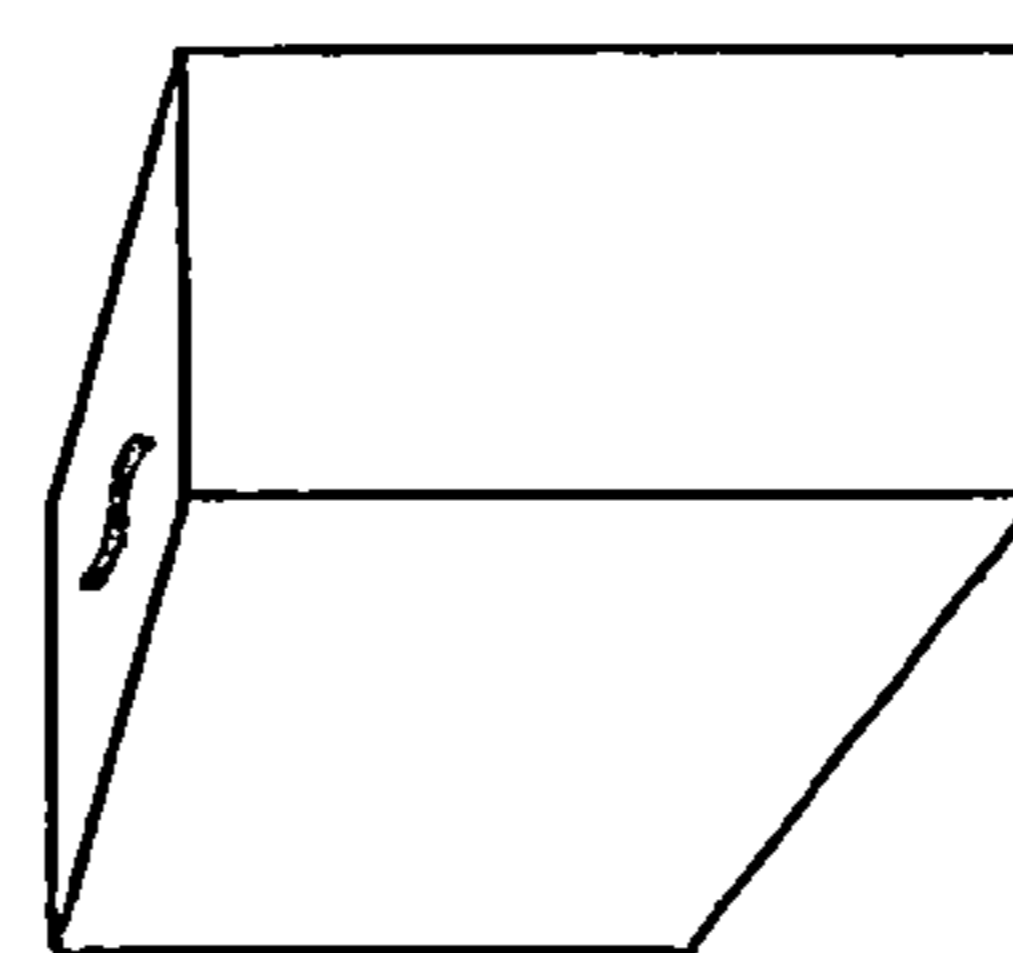

Fig. 14

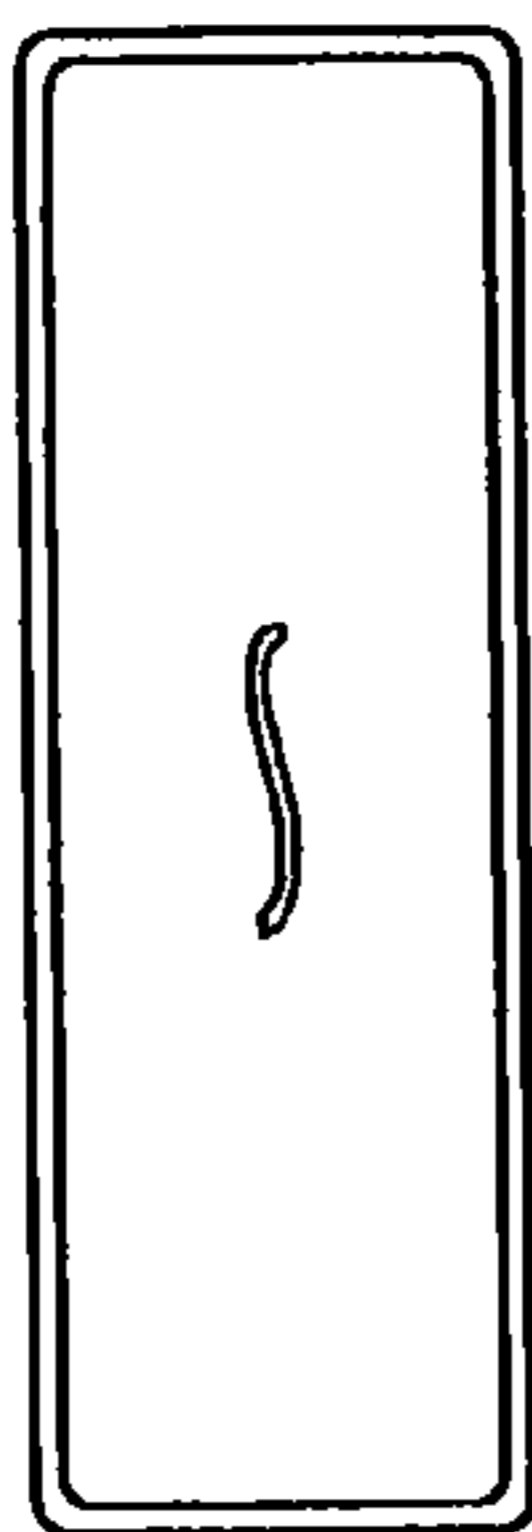

Fig. 18

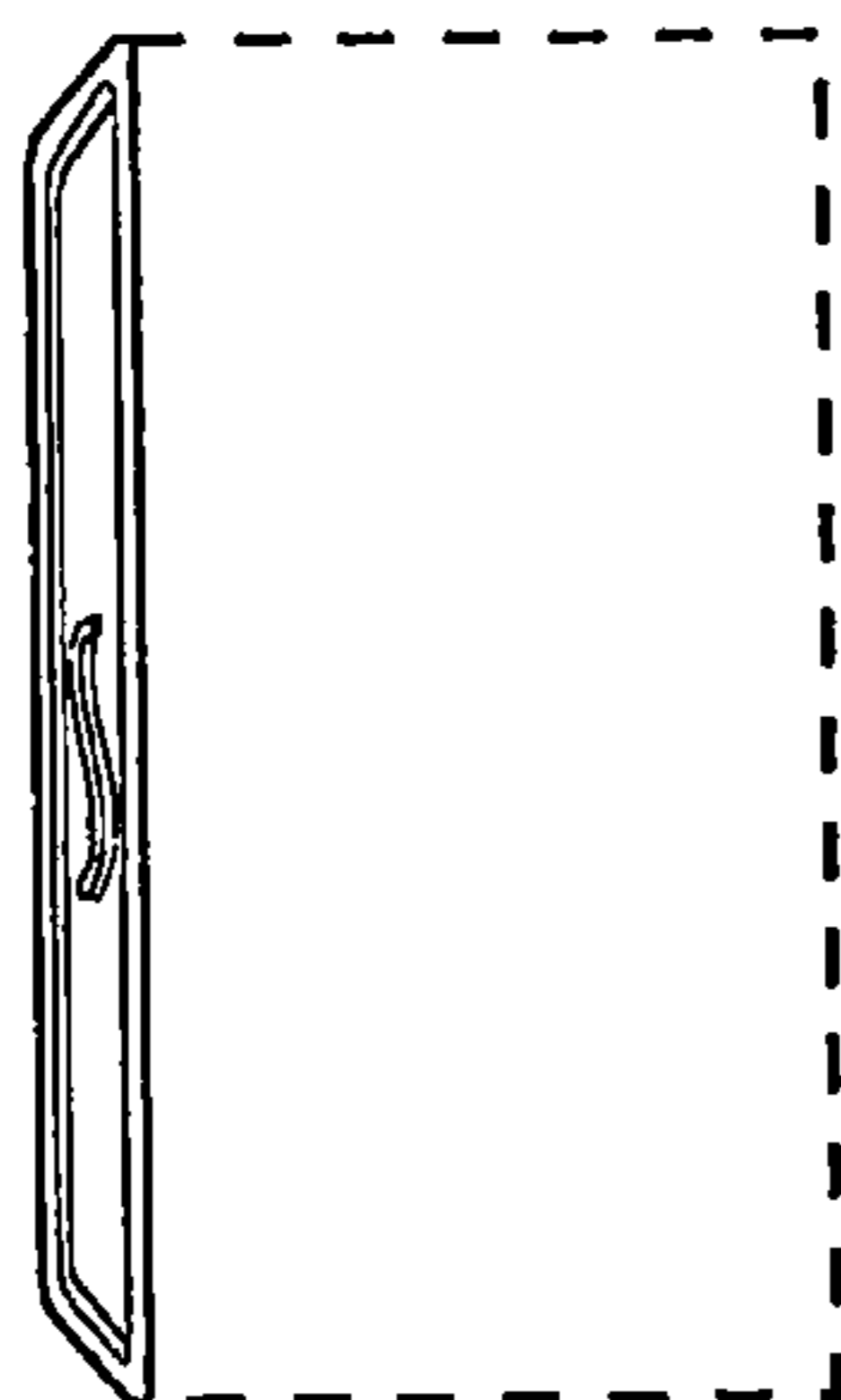

Fig. 17

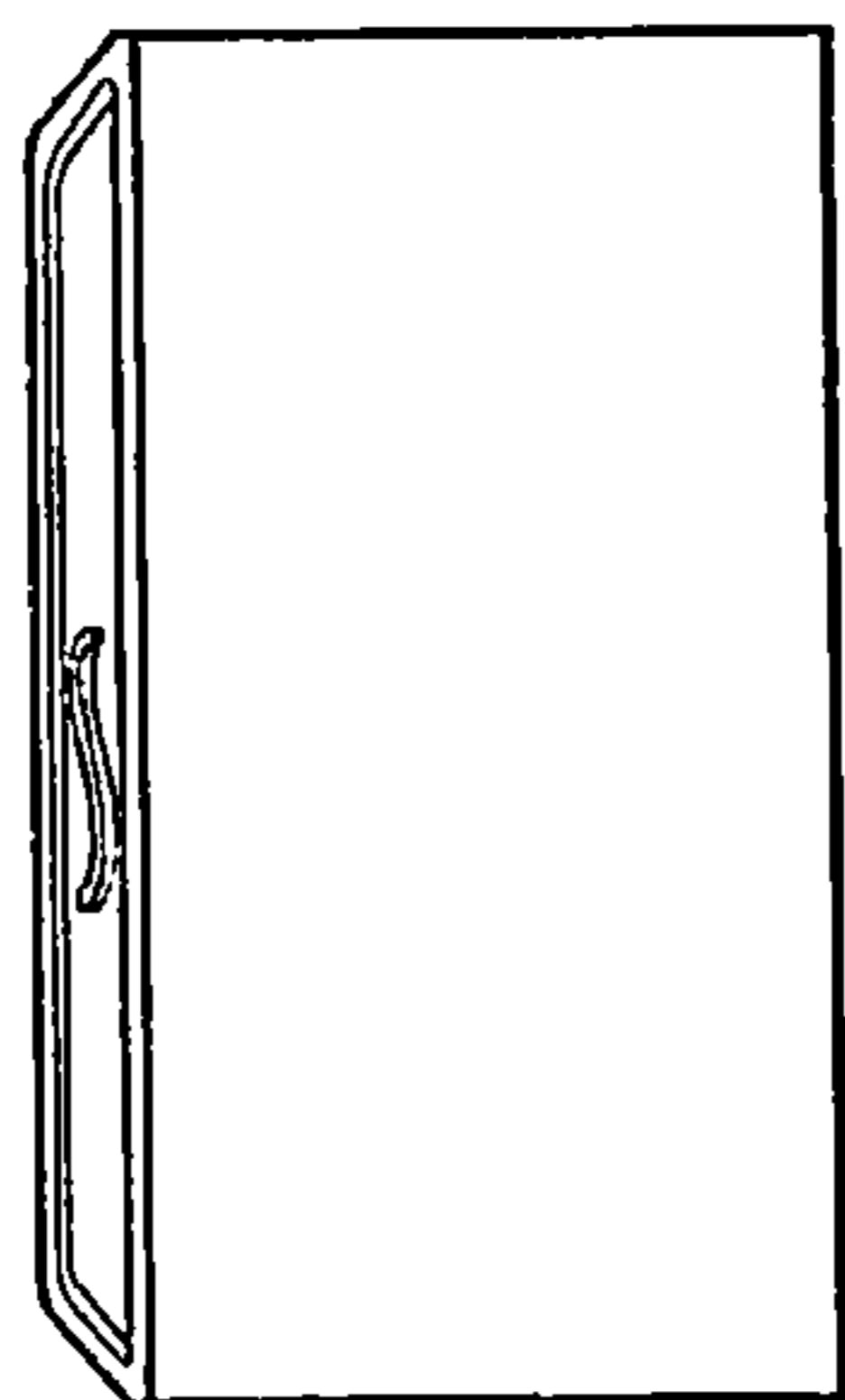

Fig. 16

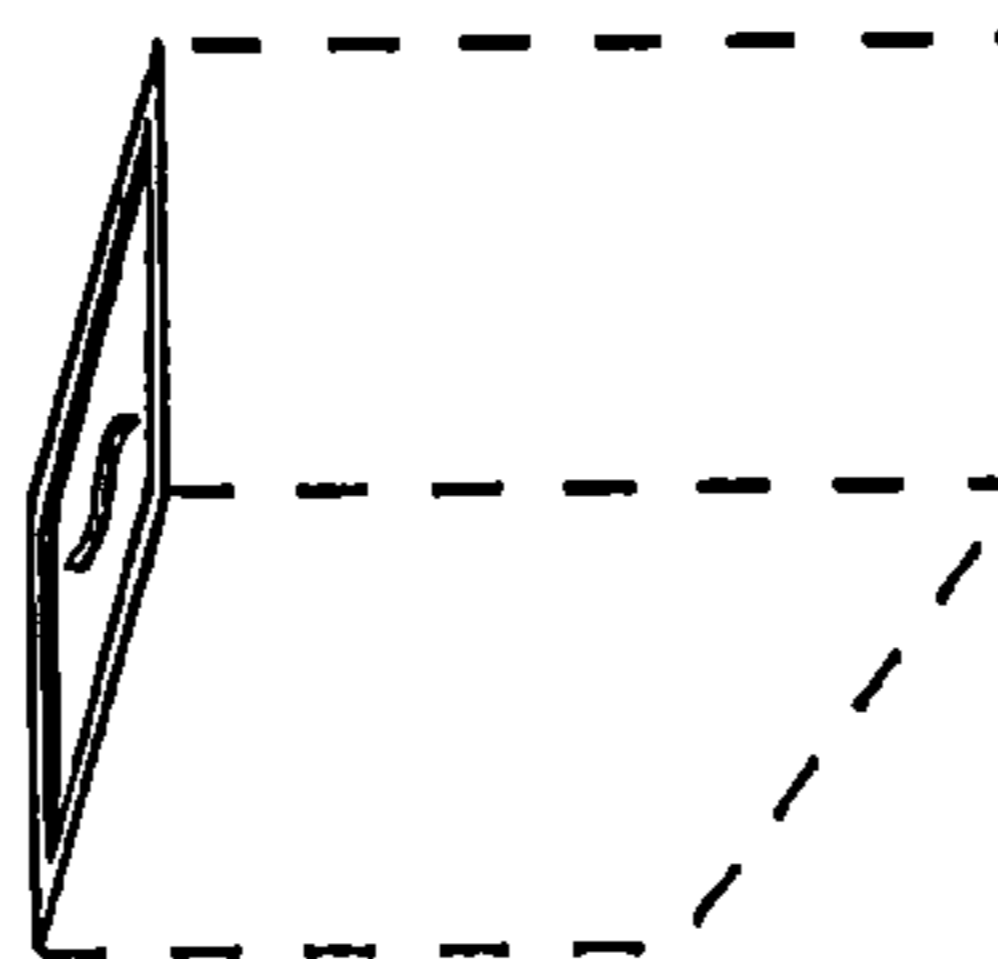

Fig. 20

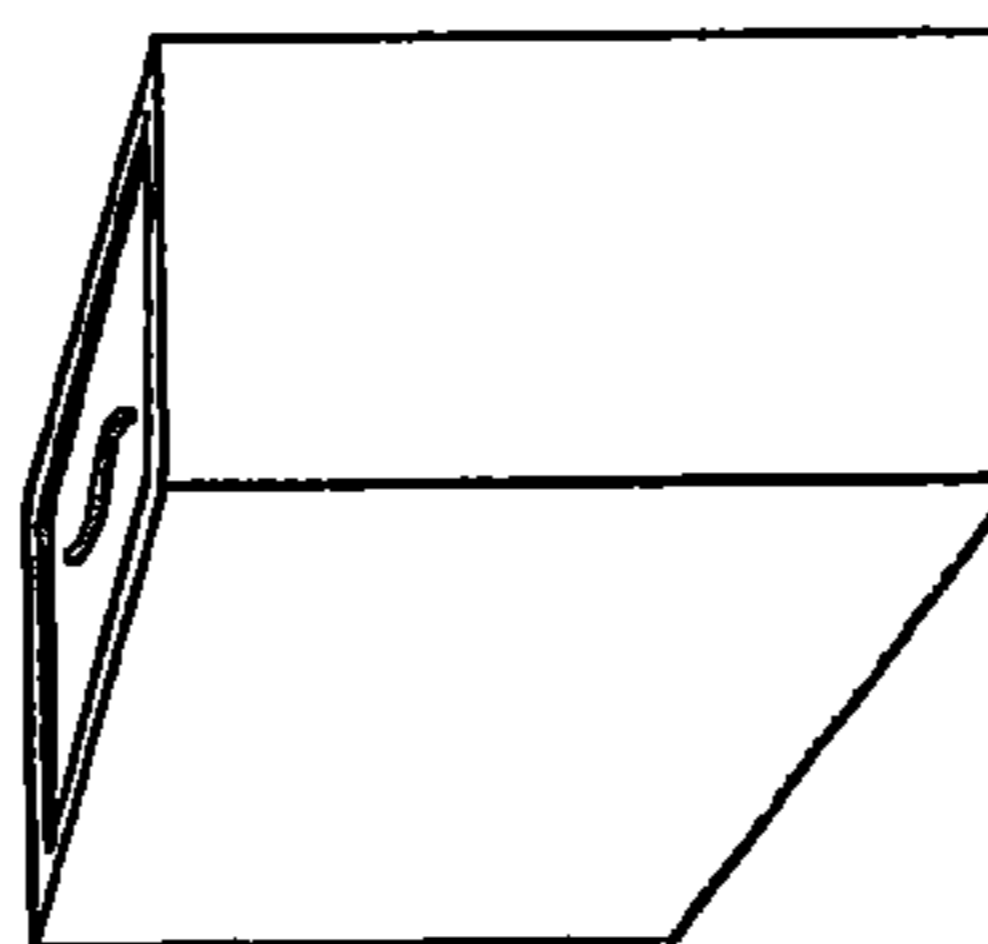

Fig. 19

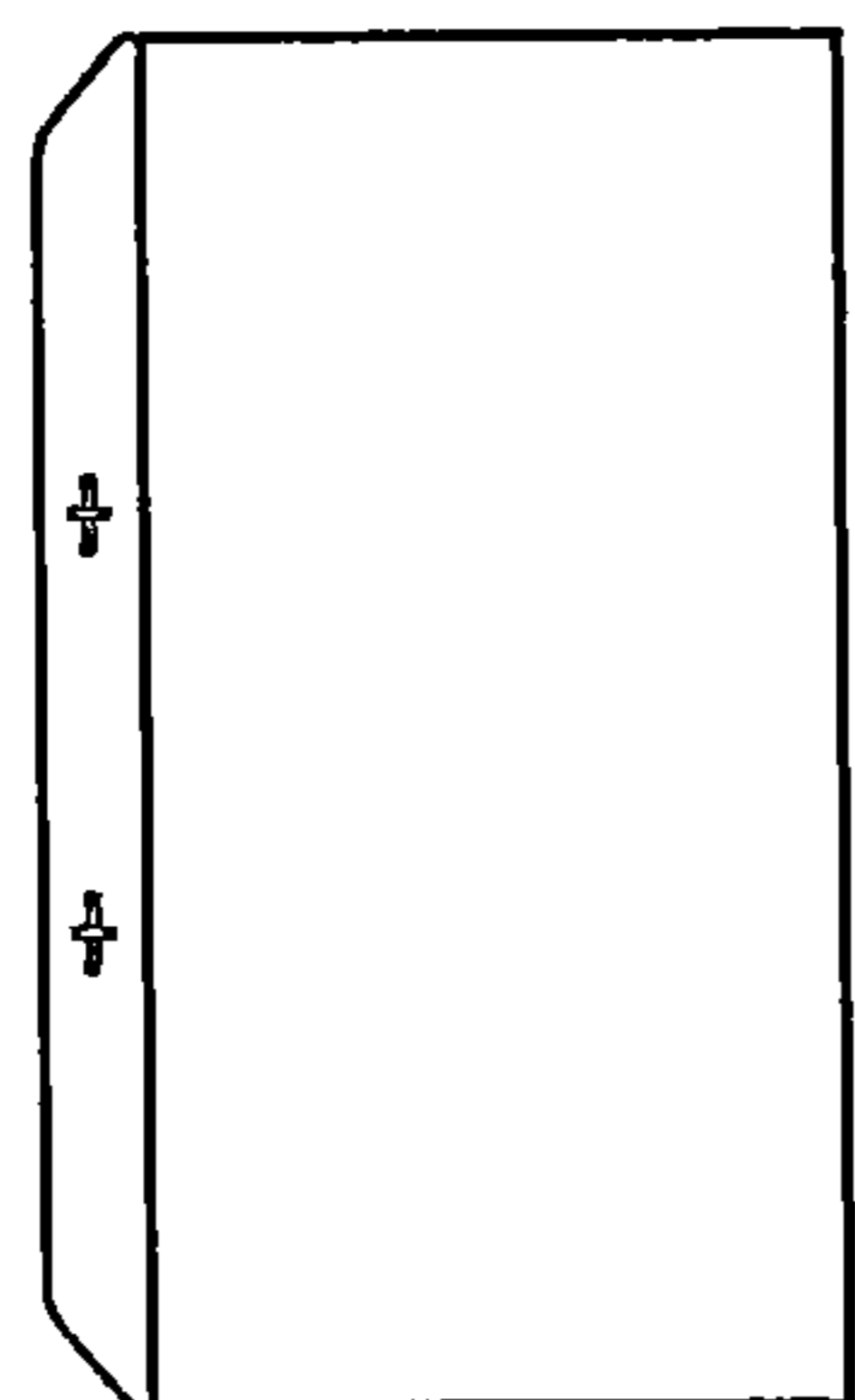

Fig. 21

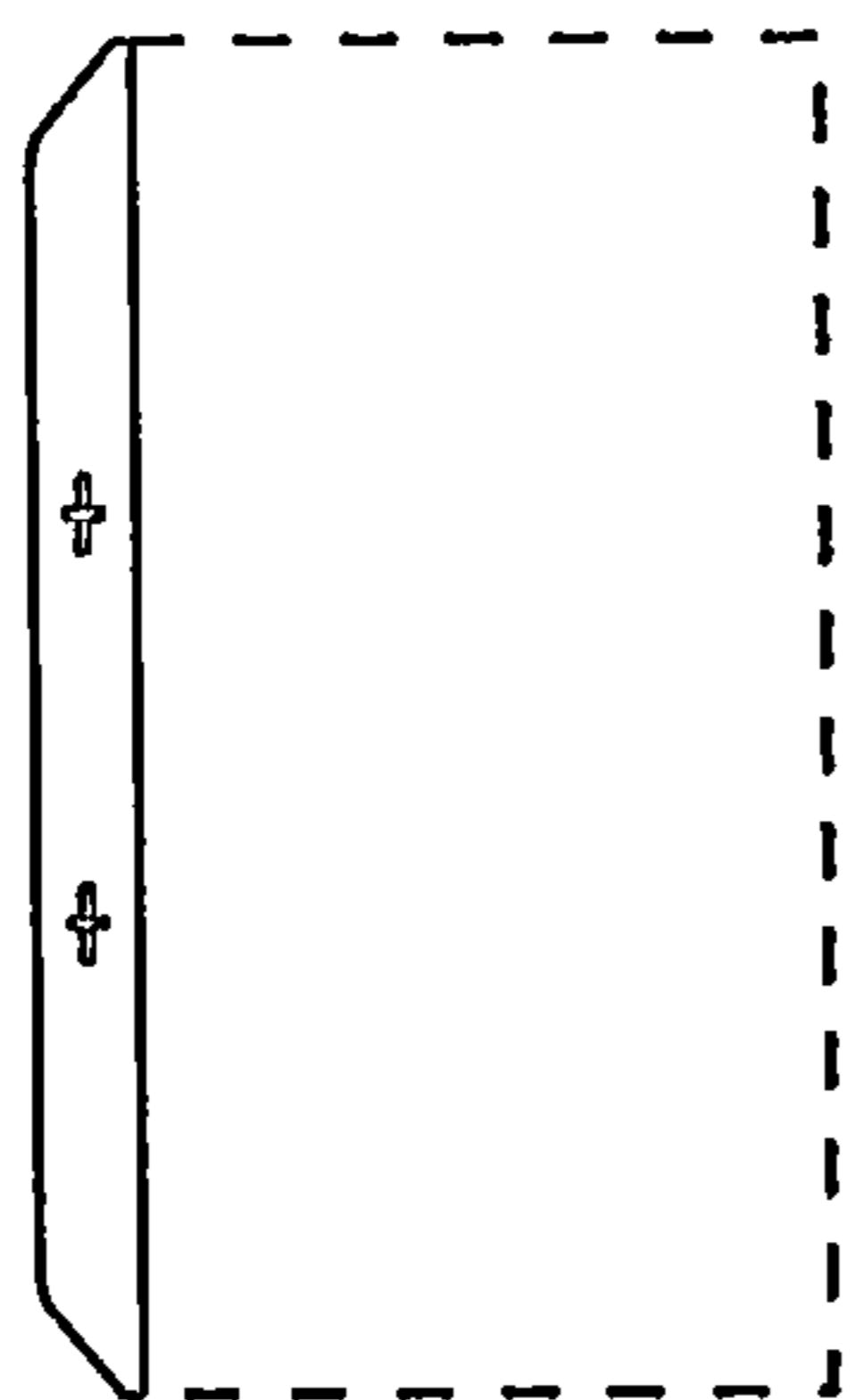

Fig. 22

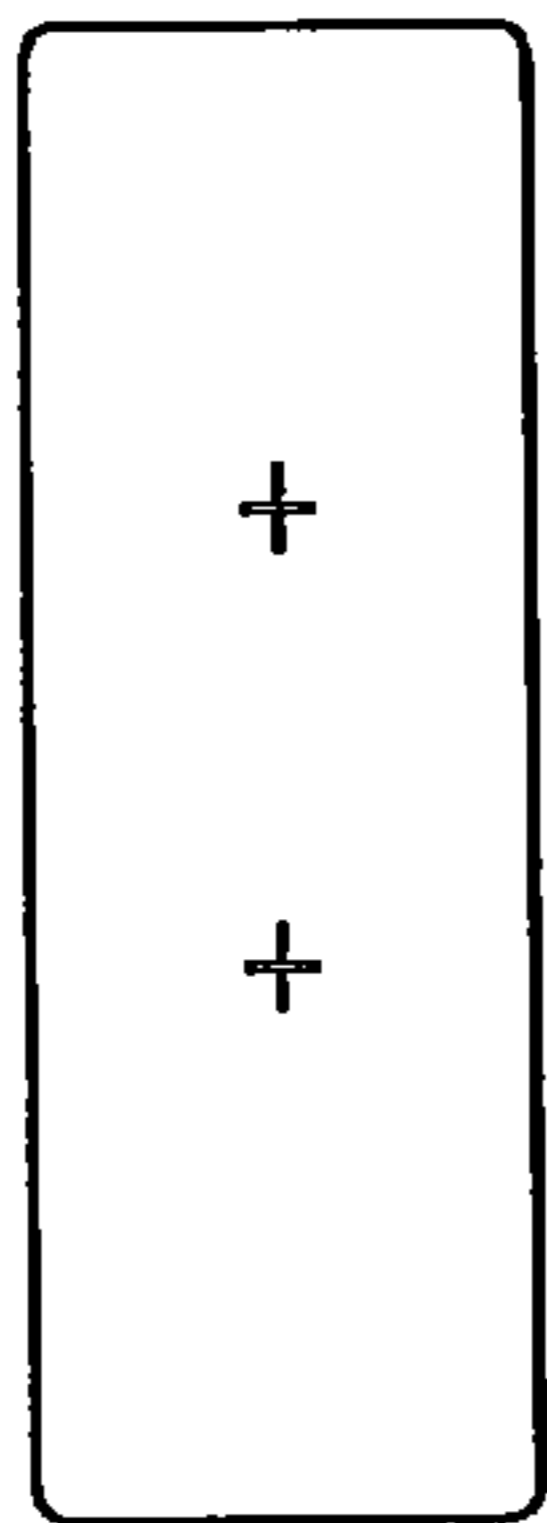

Fig. 23

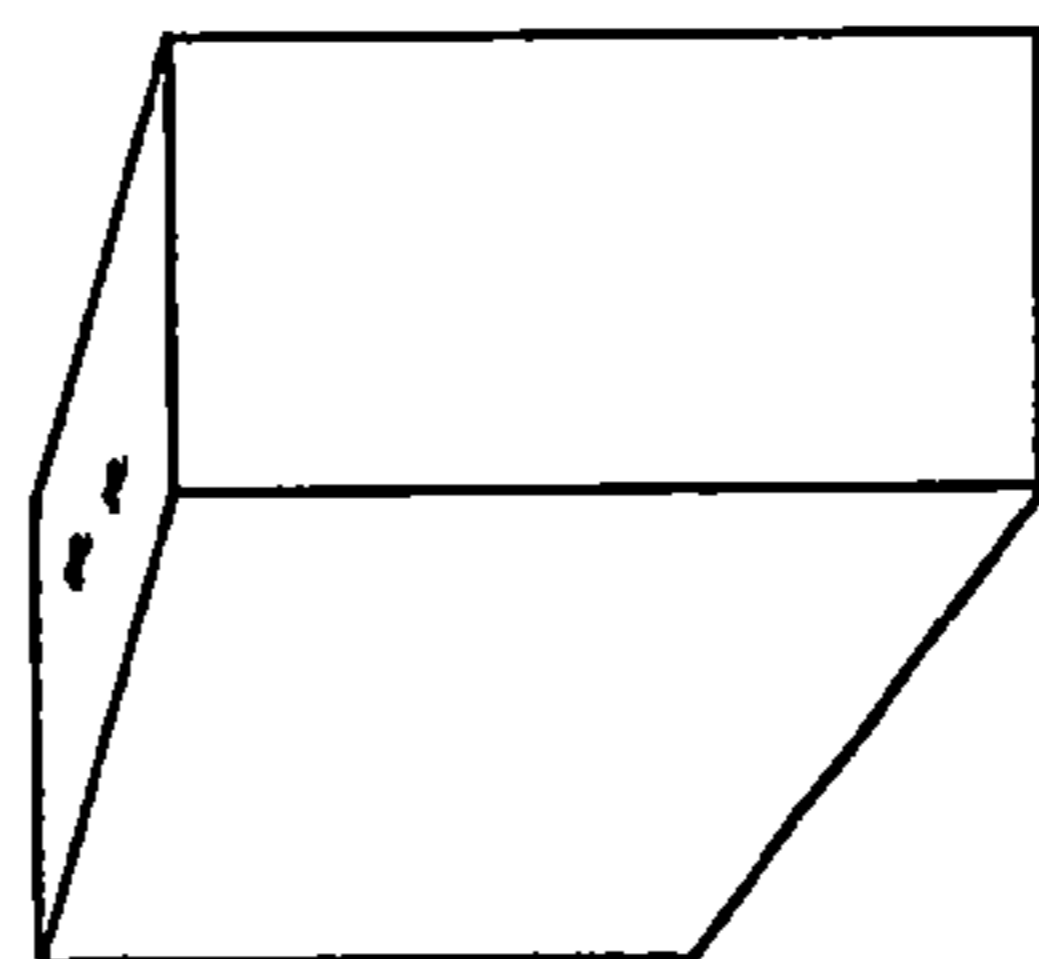

Fig. 24

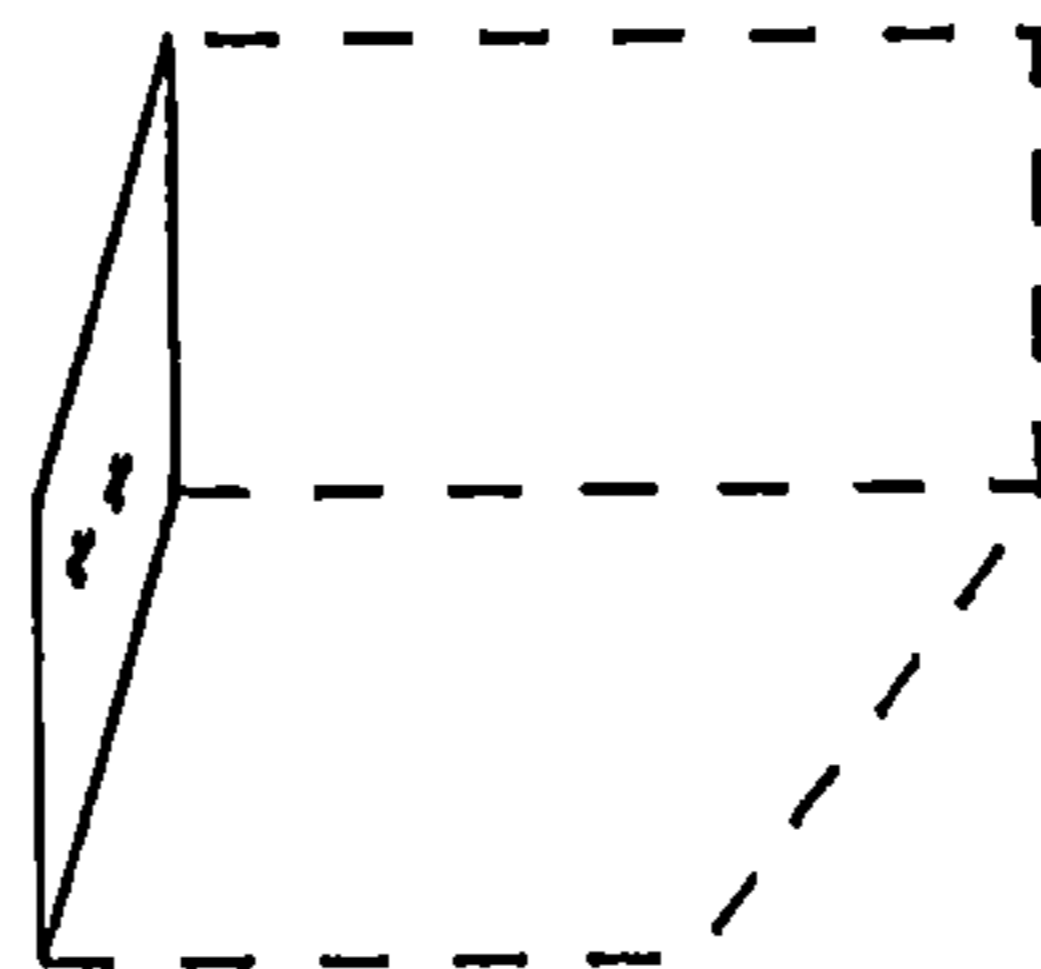

Fig. 25

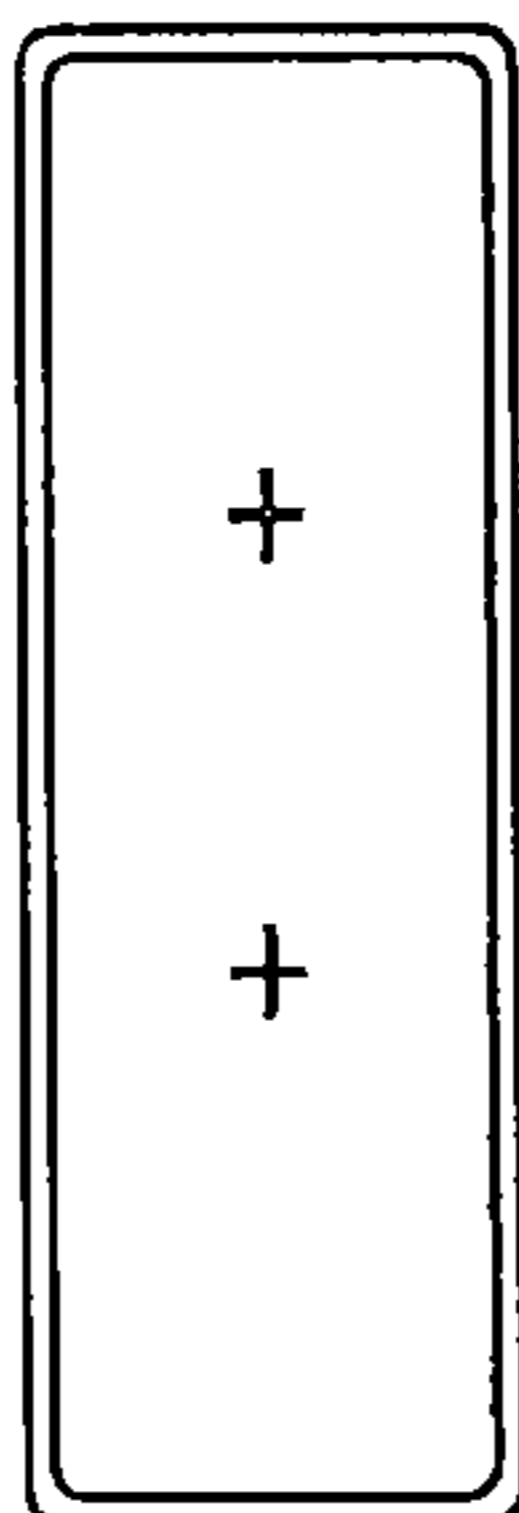

Fig. 28

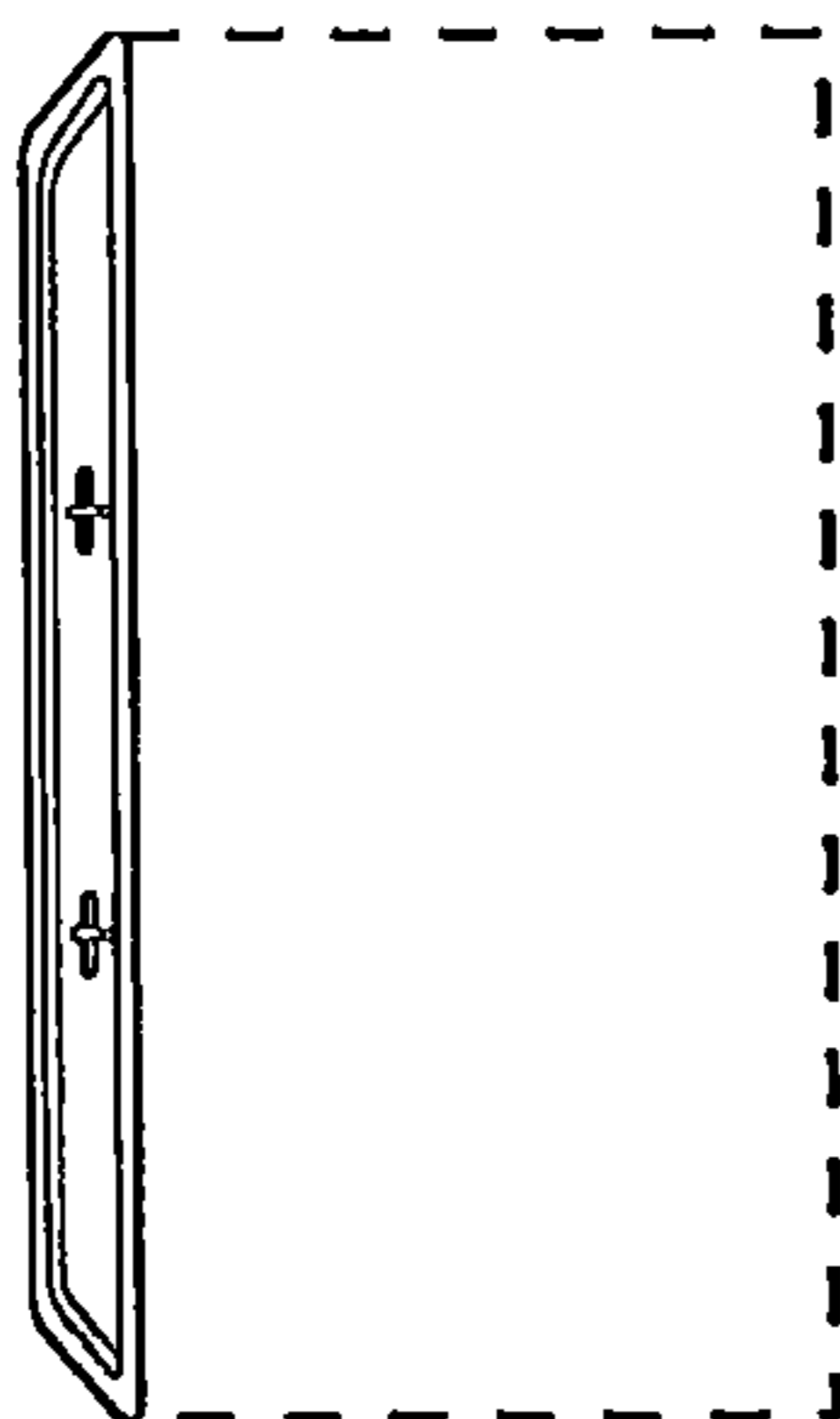

Fig. 27

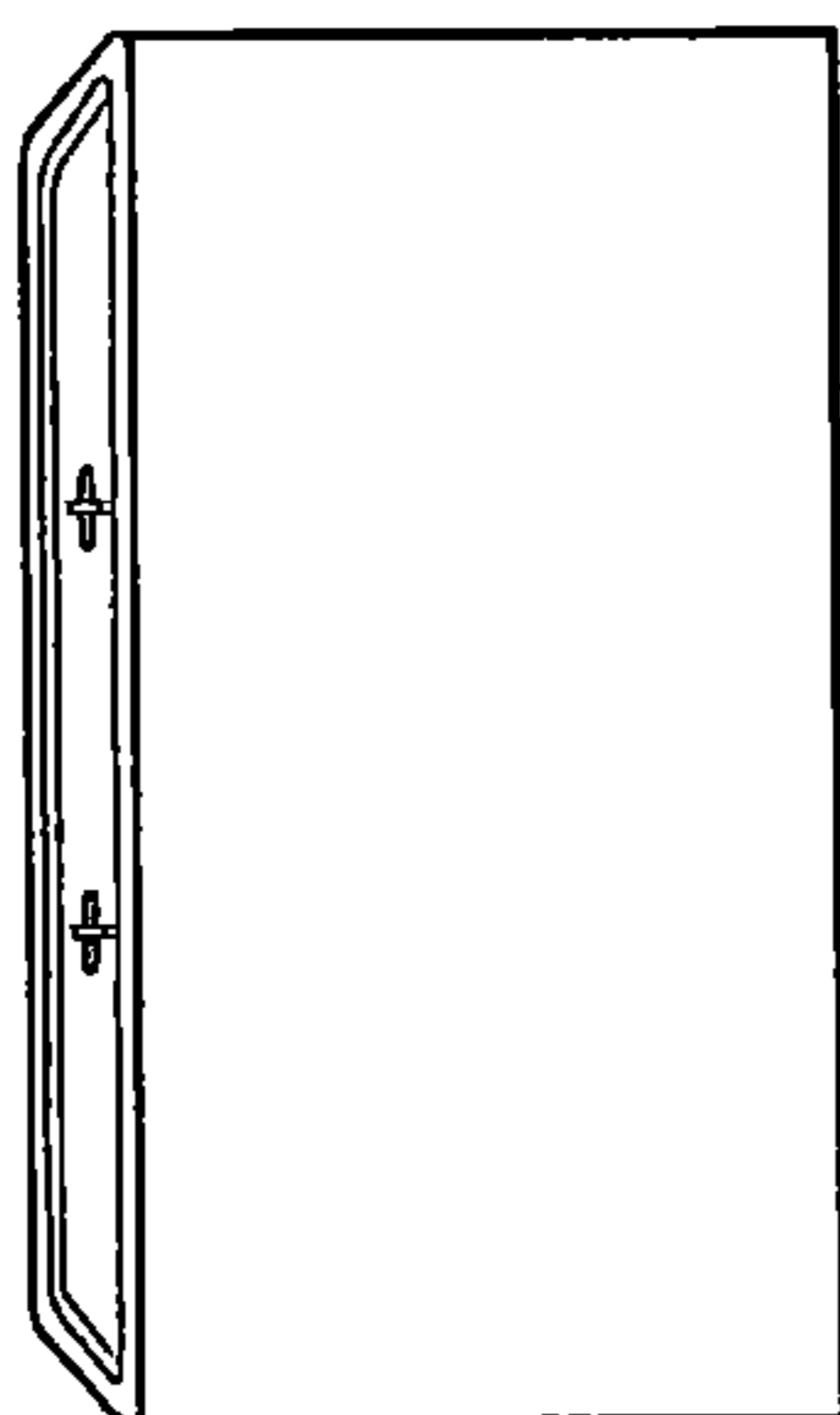

Fig. 26

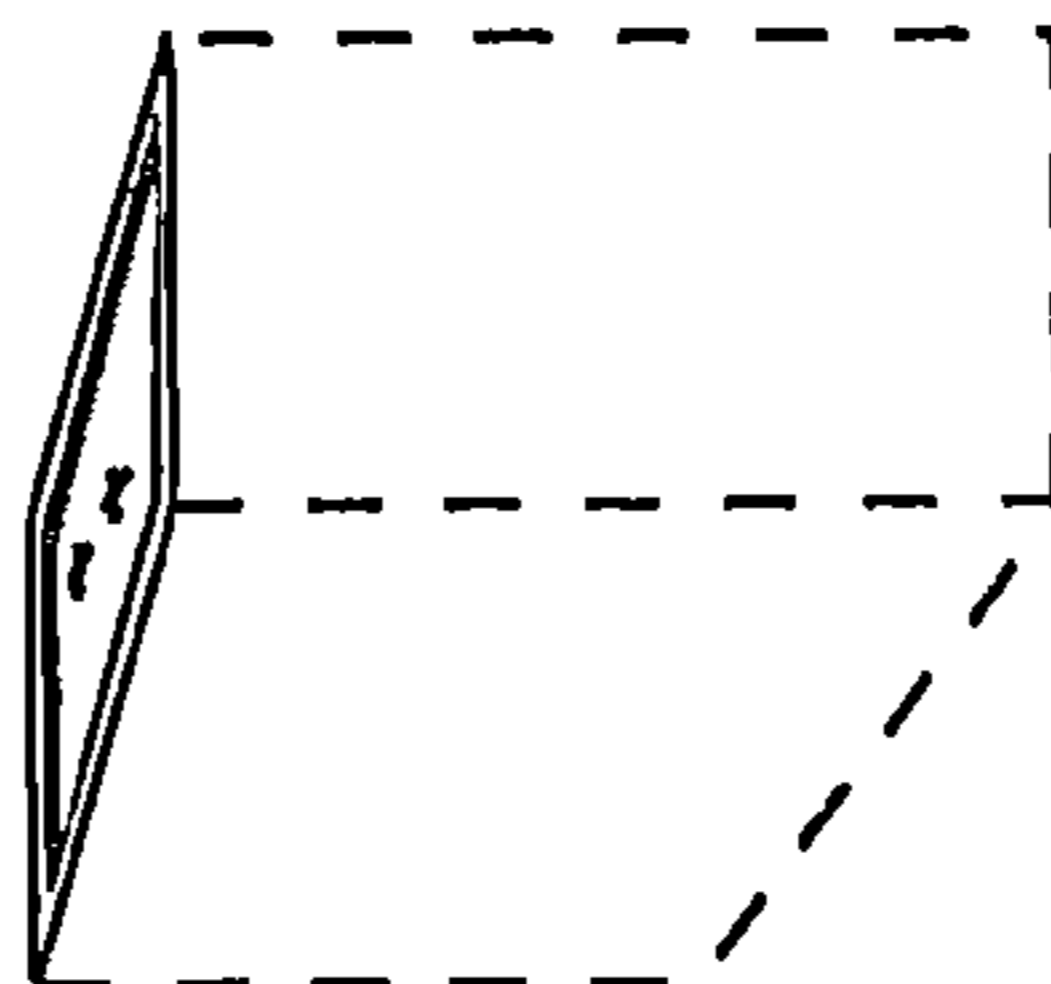

Fig. 30

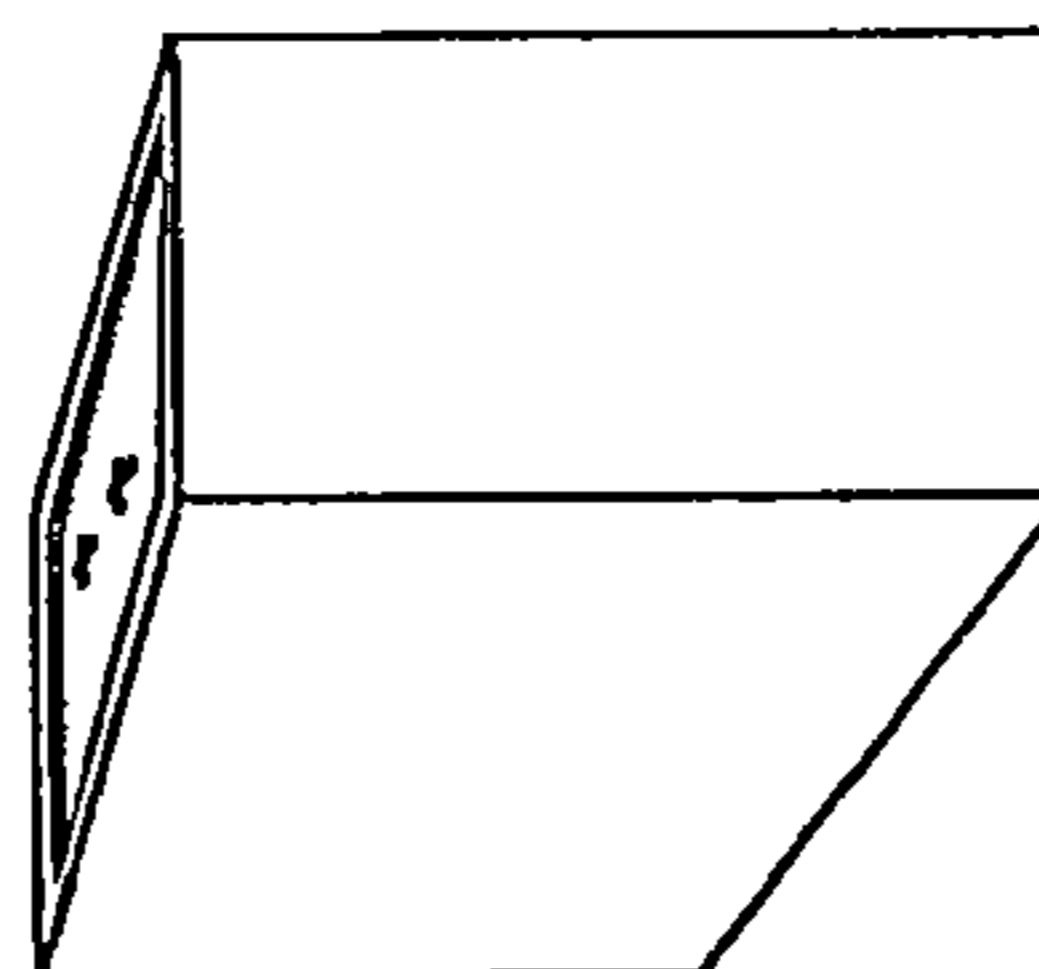

Fig. 29

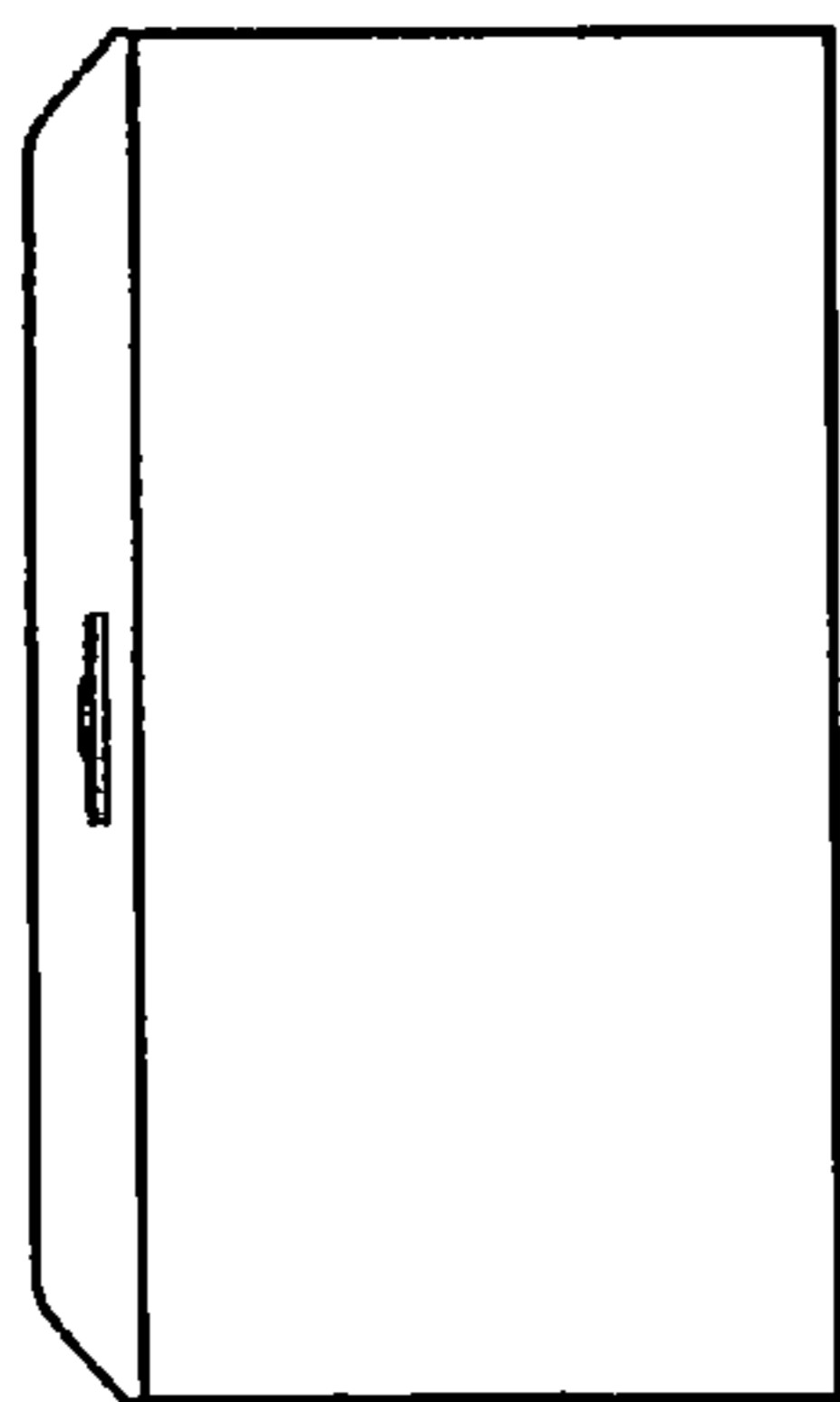

Fig. 31

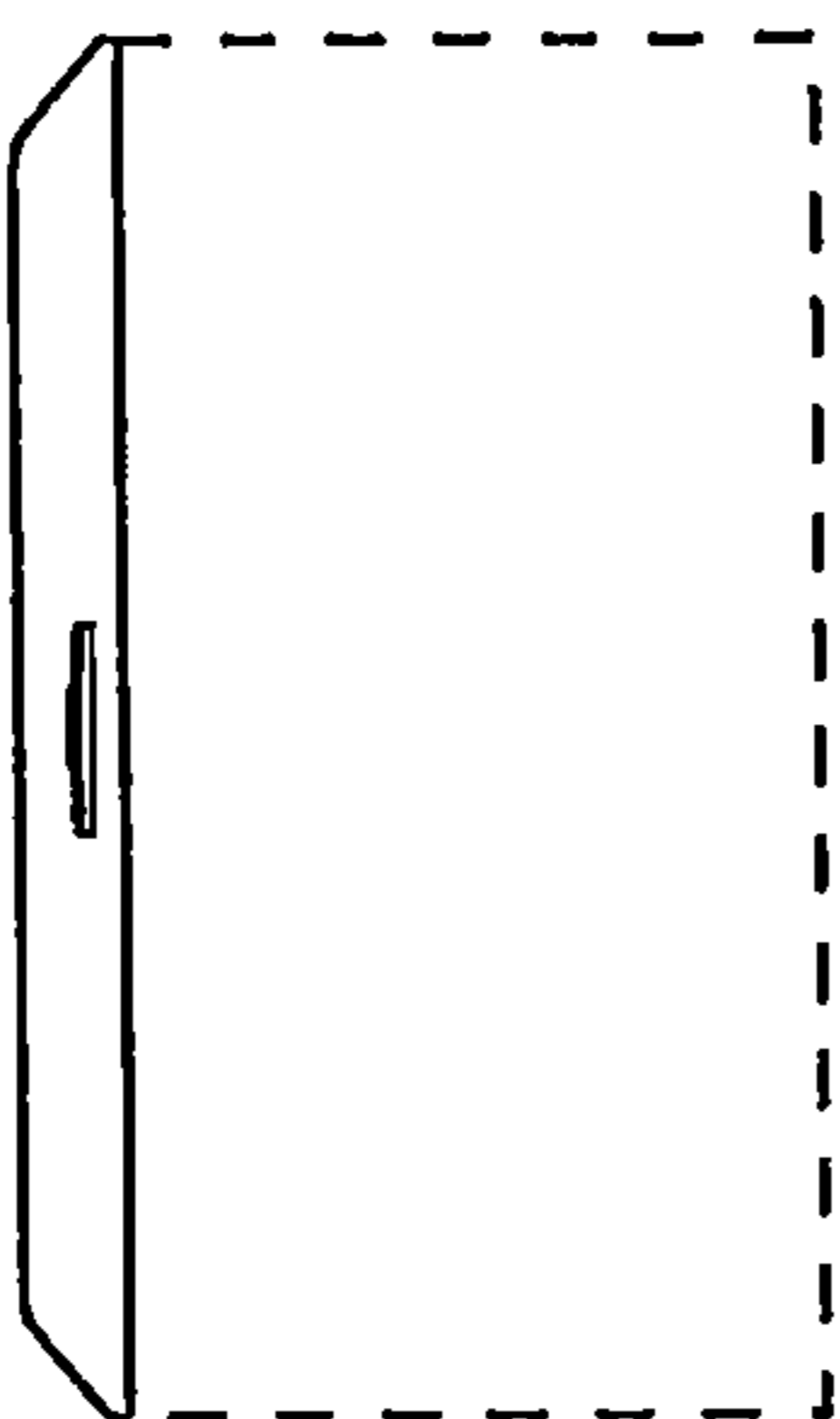

Fig. 32

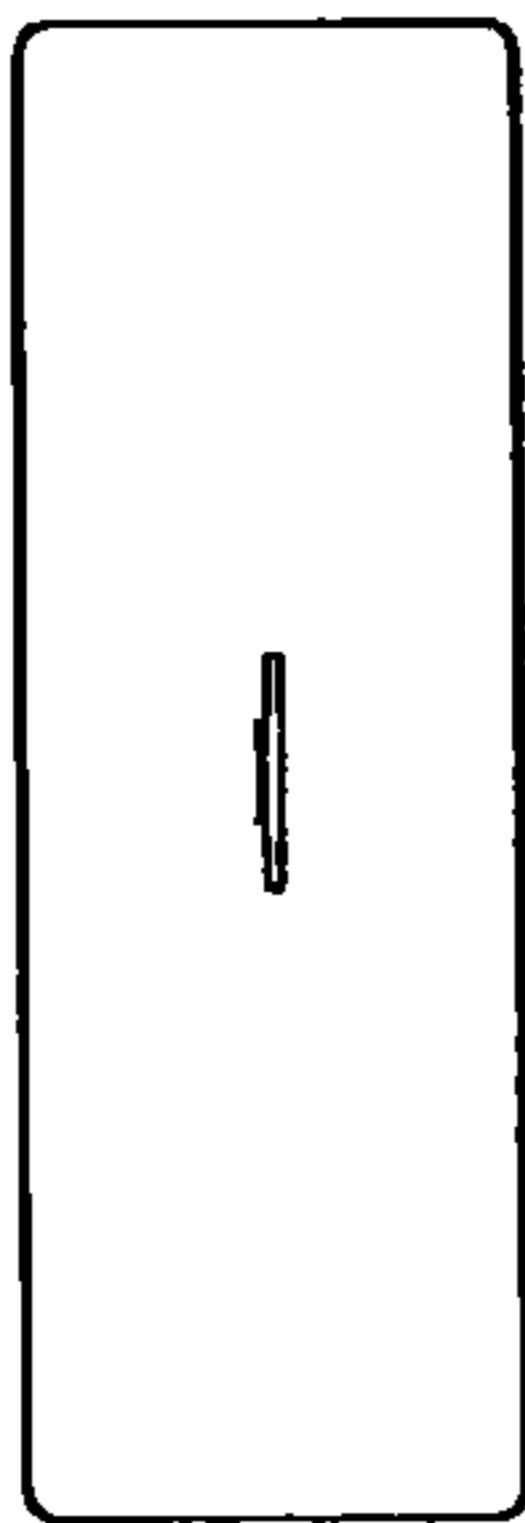

Fig. 33

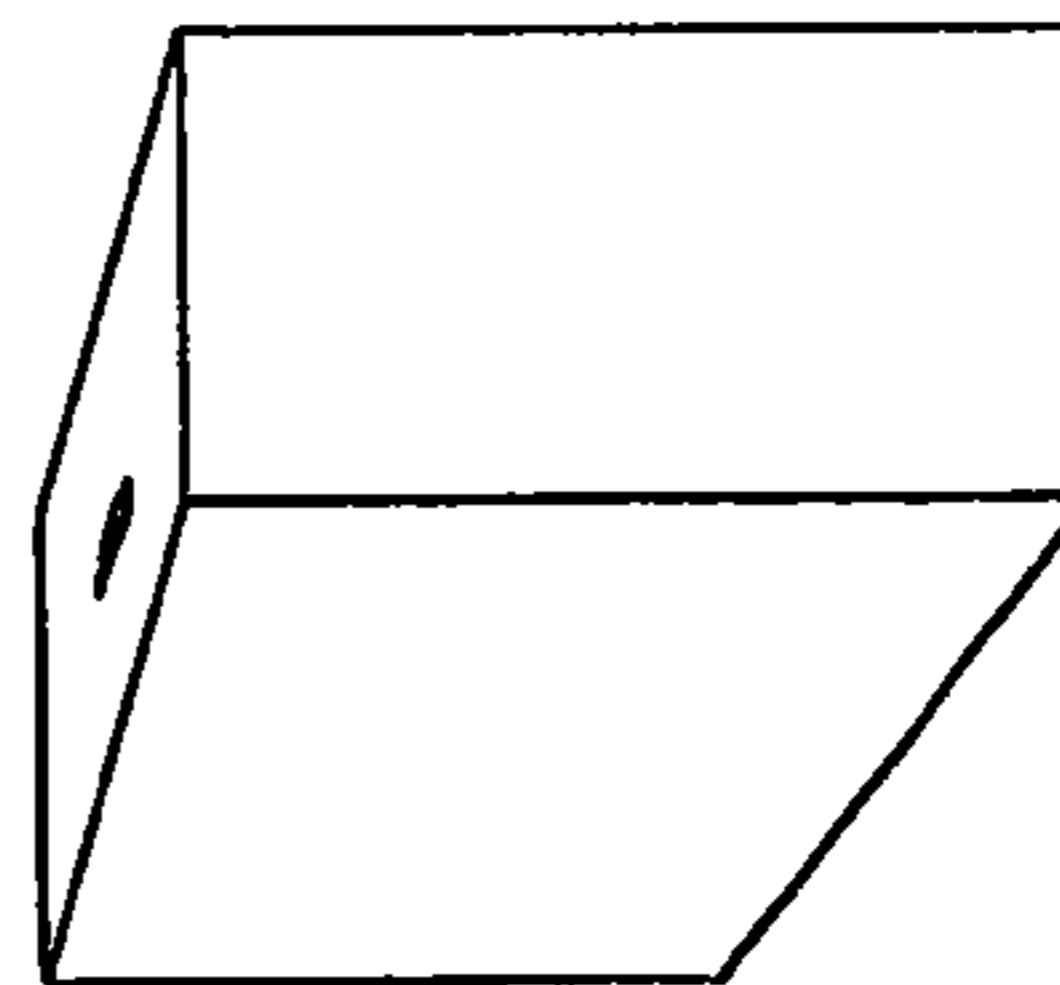

Fig. 34

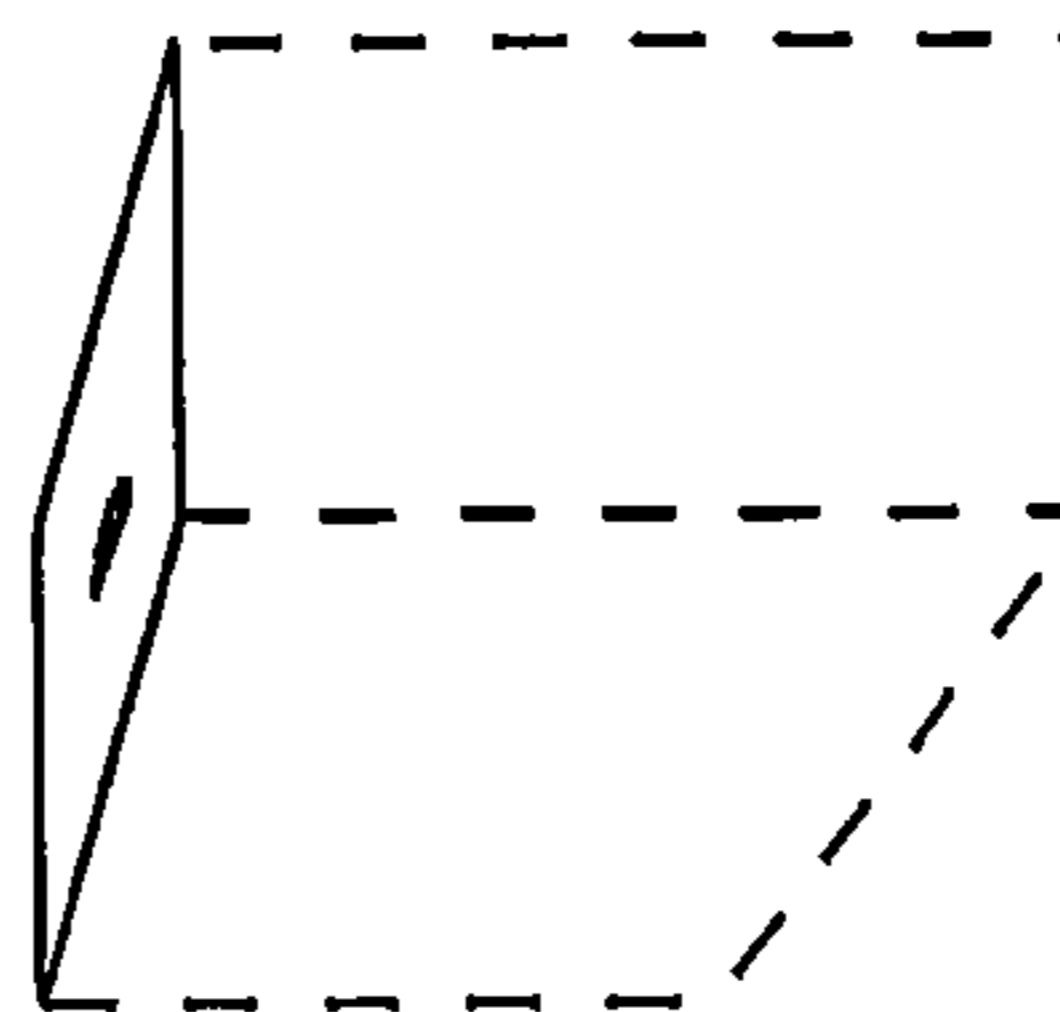

Fig. 35

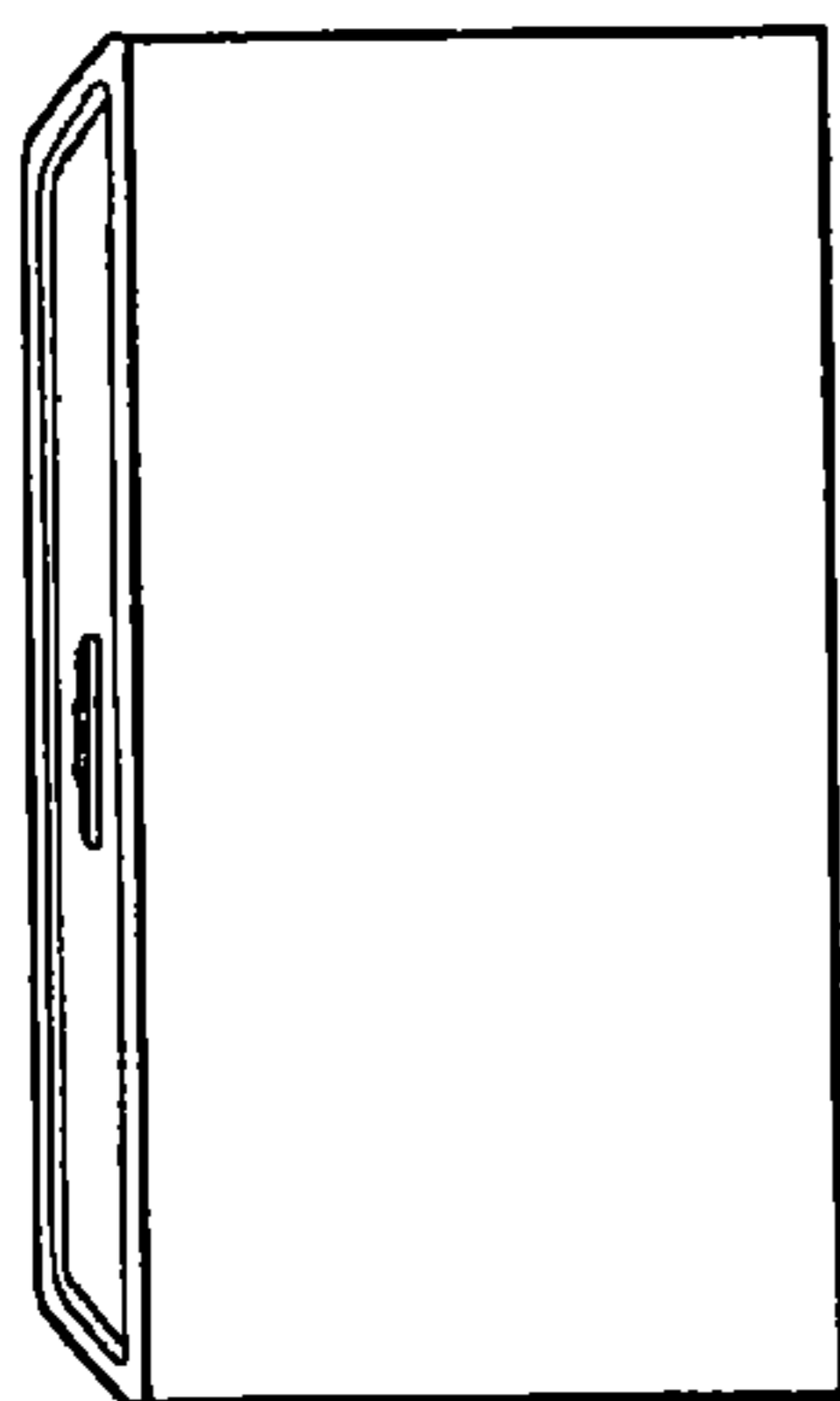

Fig. 36

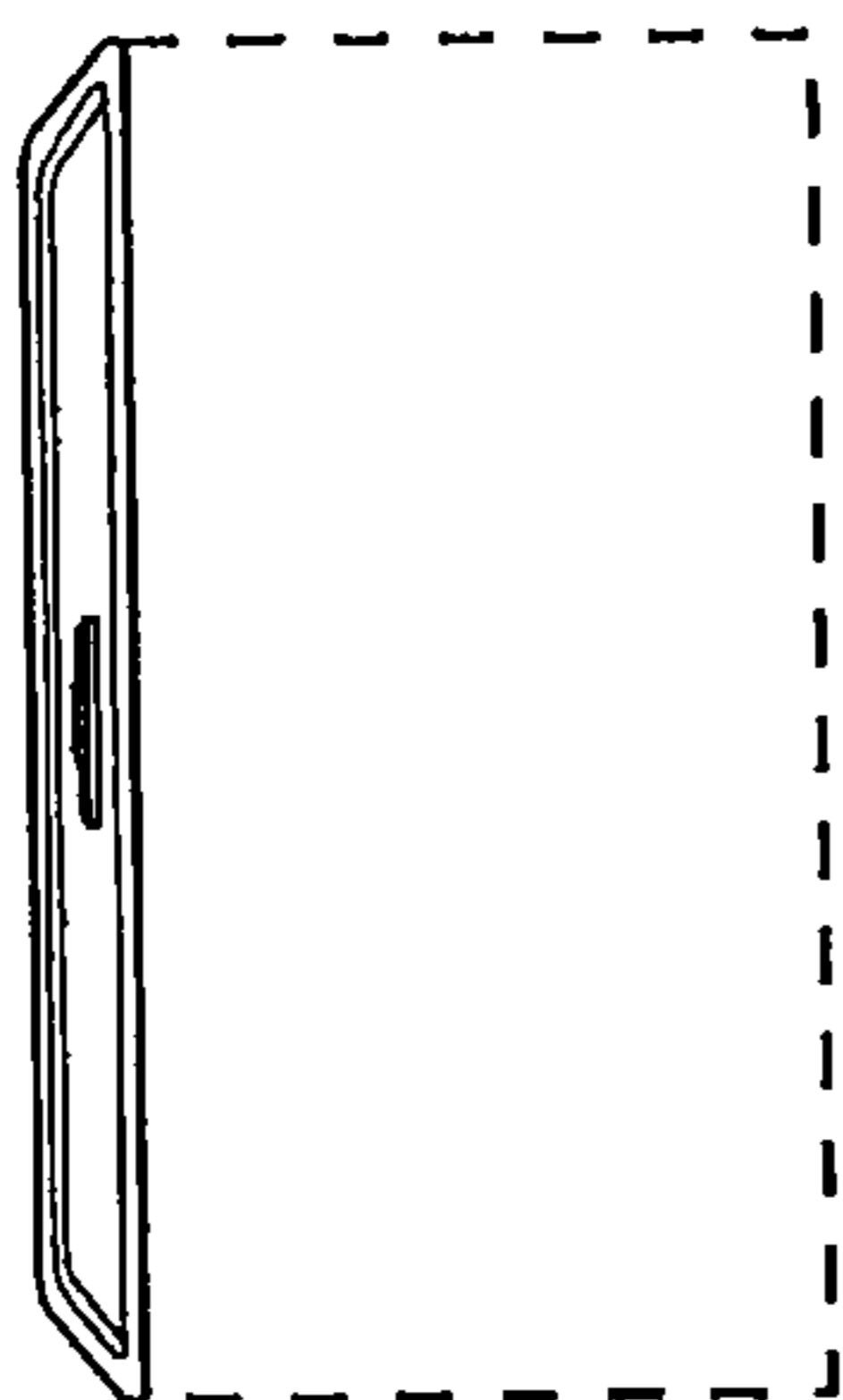

Fig. 37

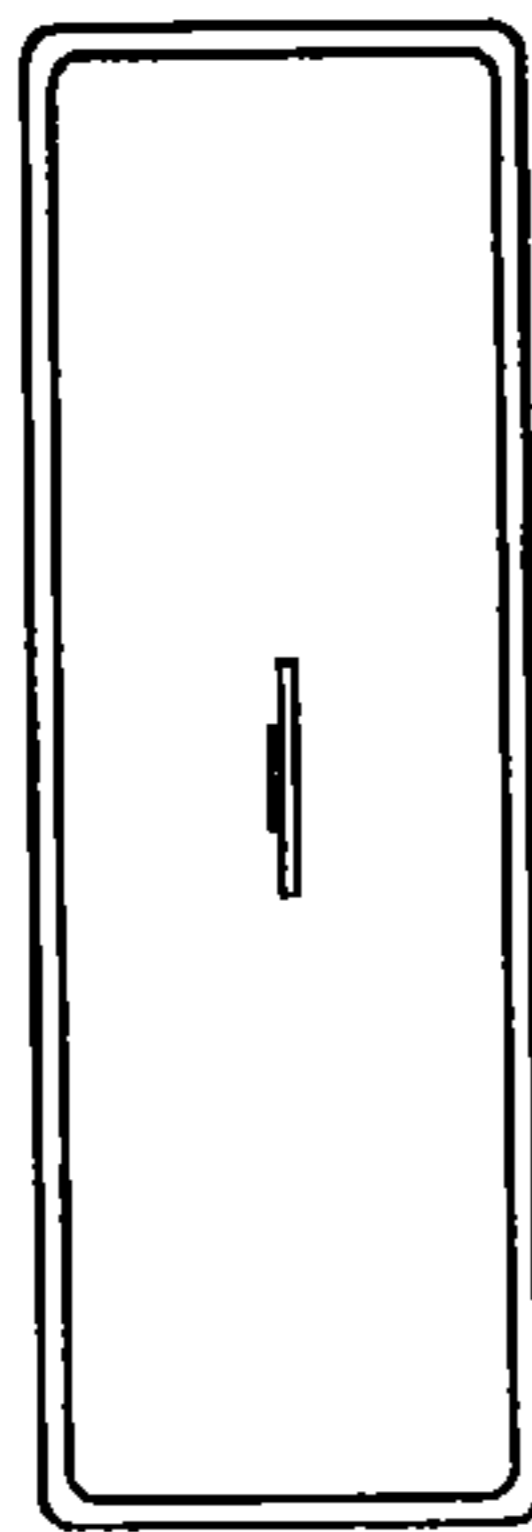

Fig. 38

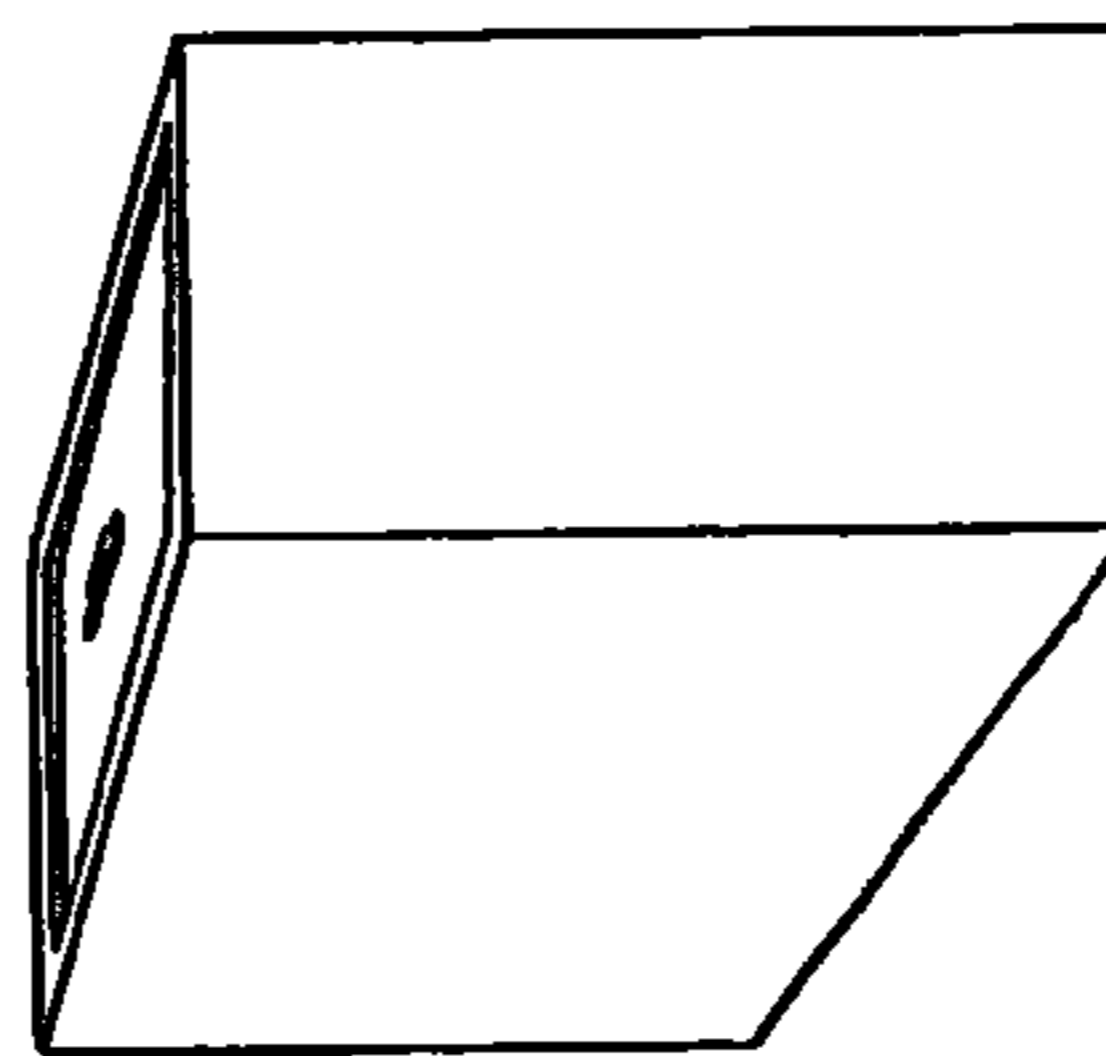

Fig. 39

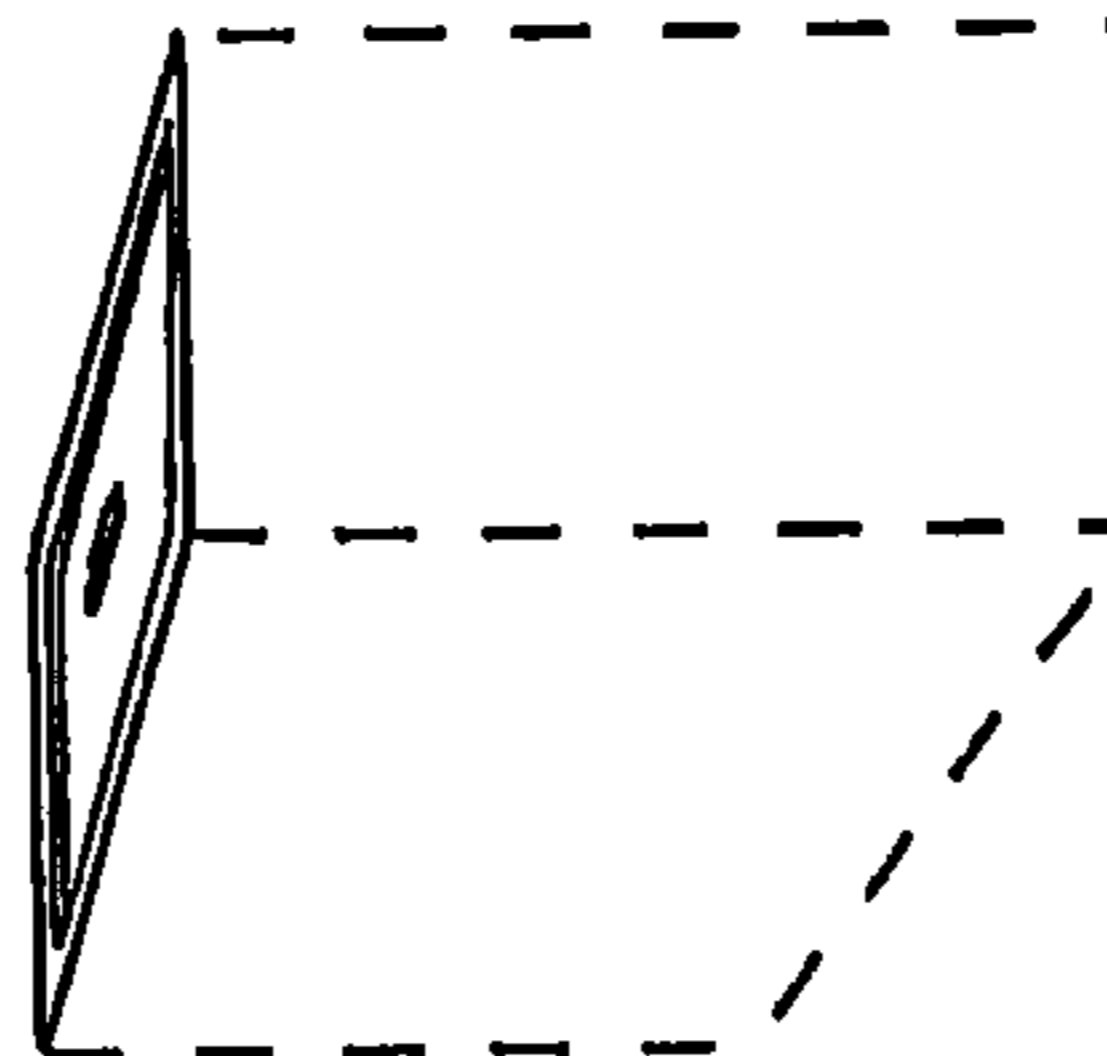

Fig. 40

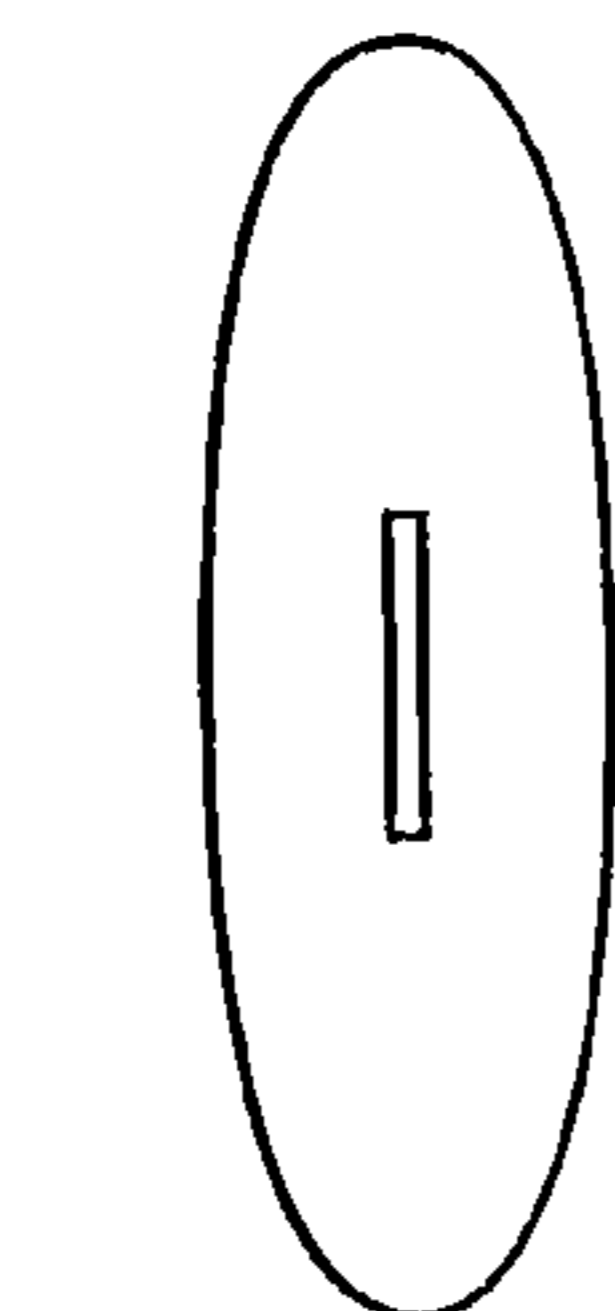

Fig. 43

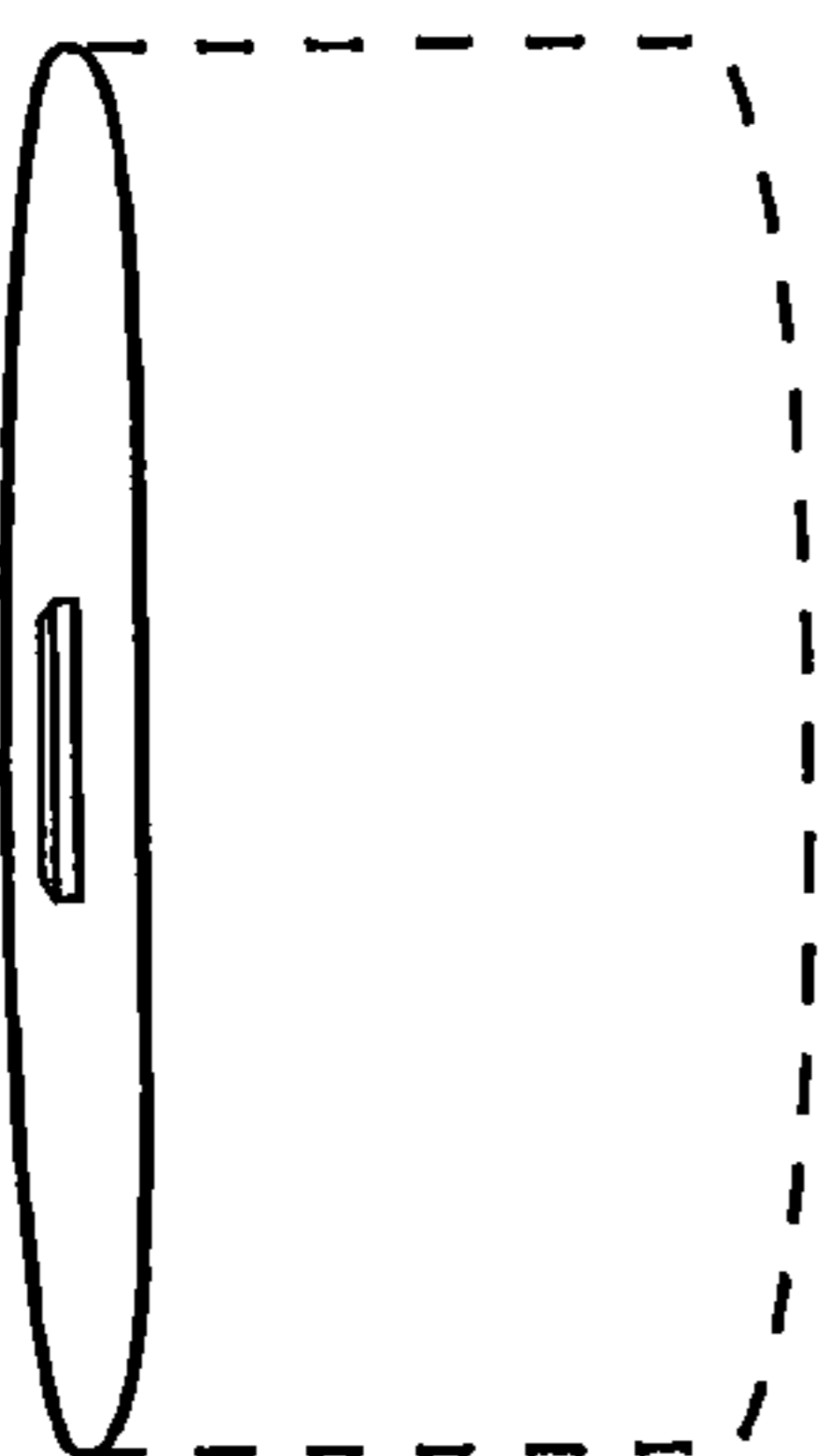

Fig. 42

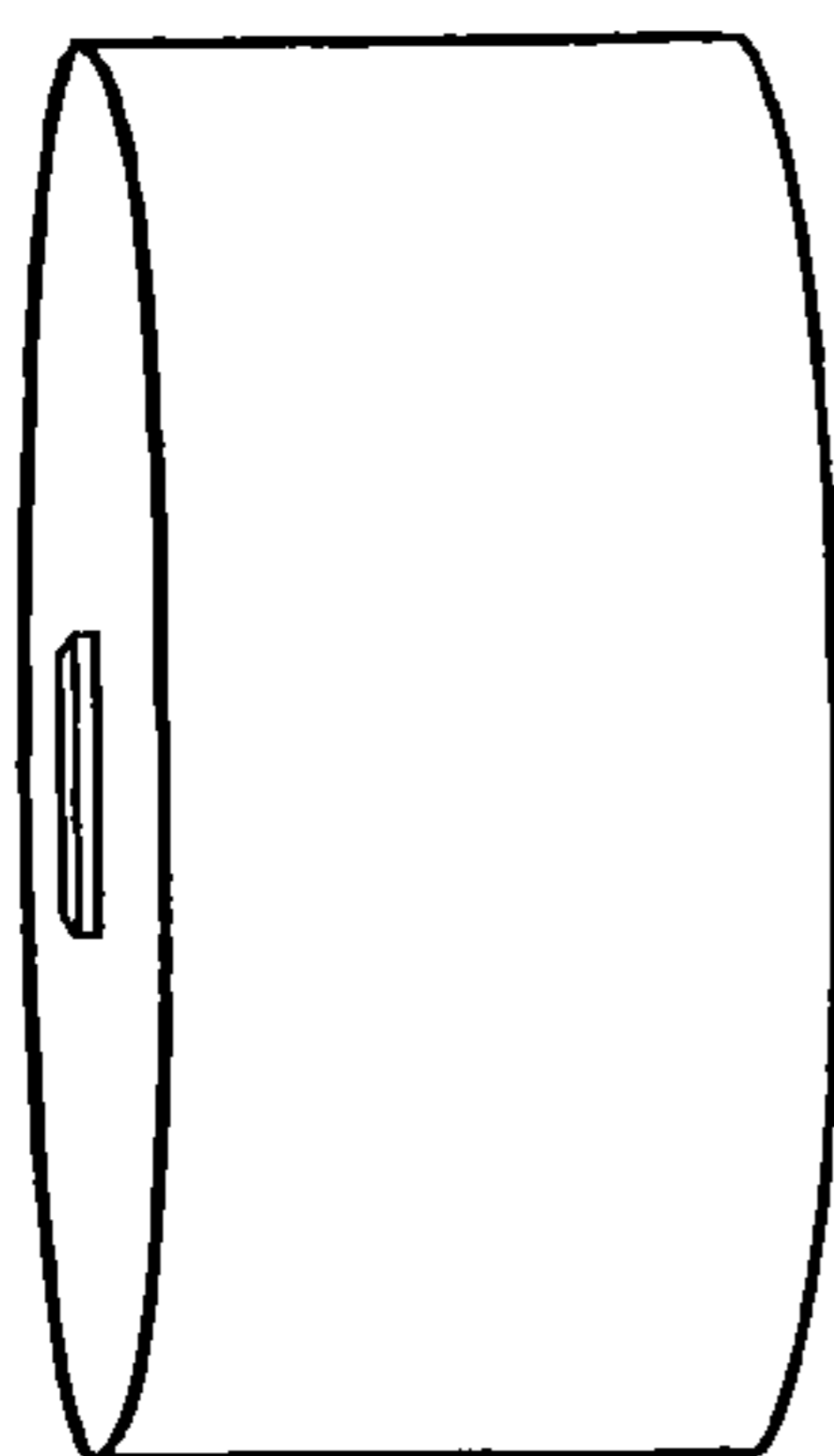

Fig. 41

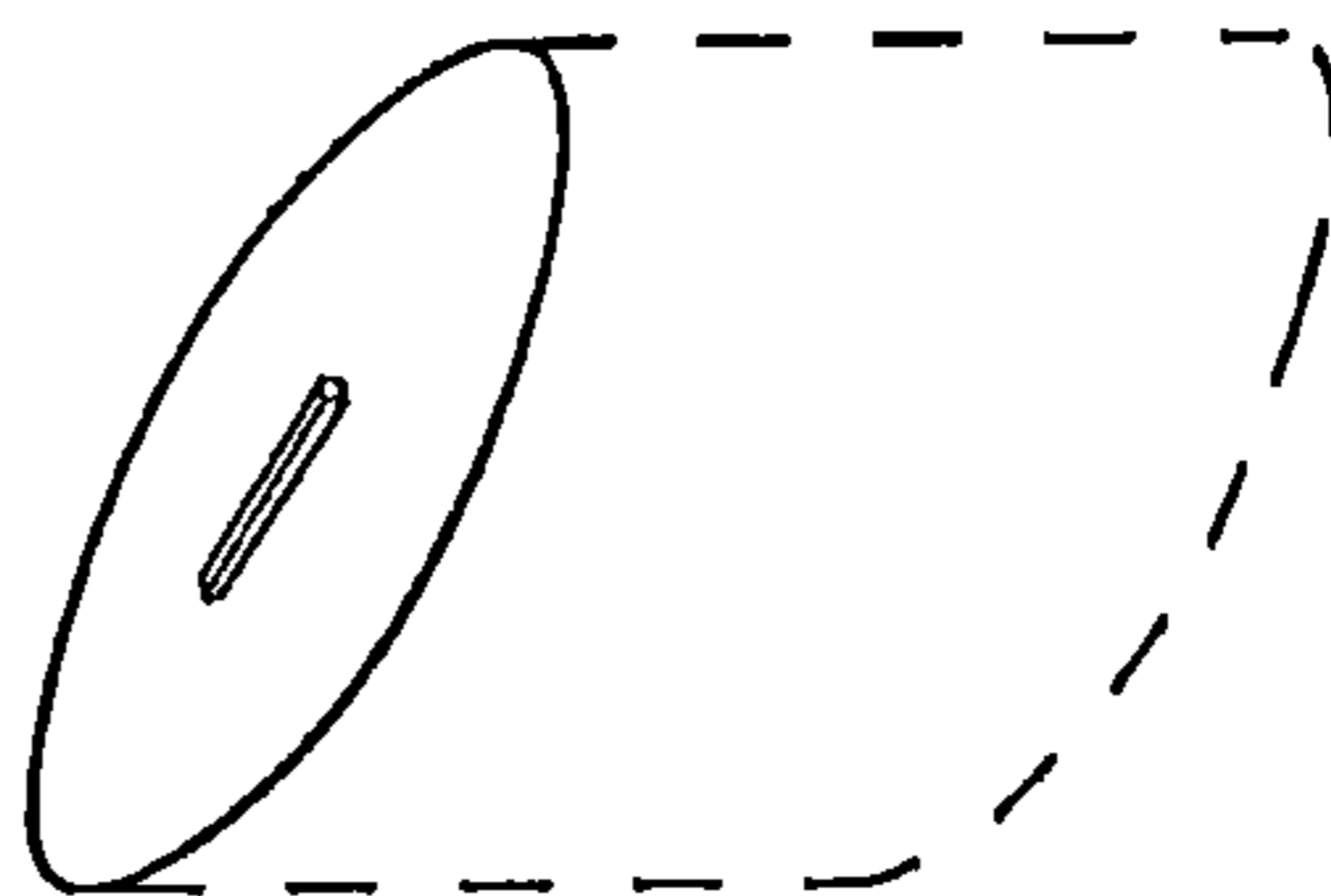

Fig. 45

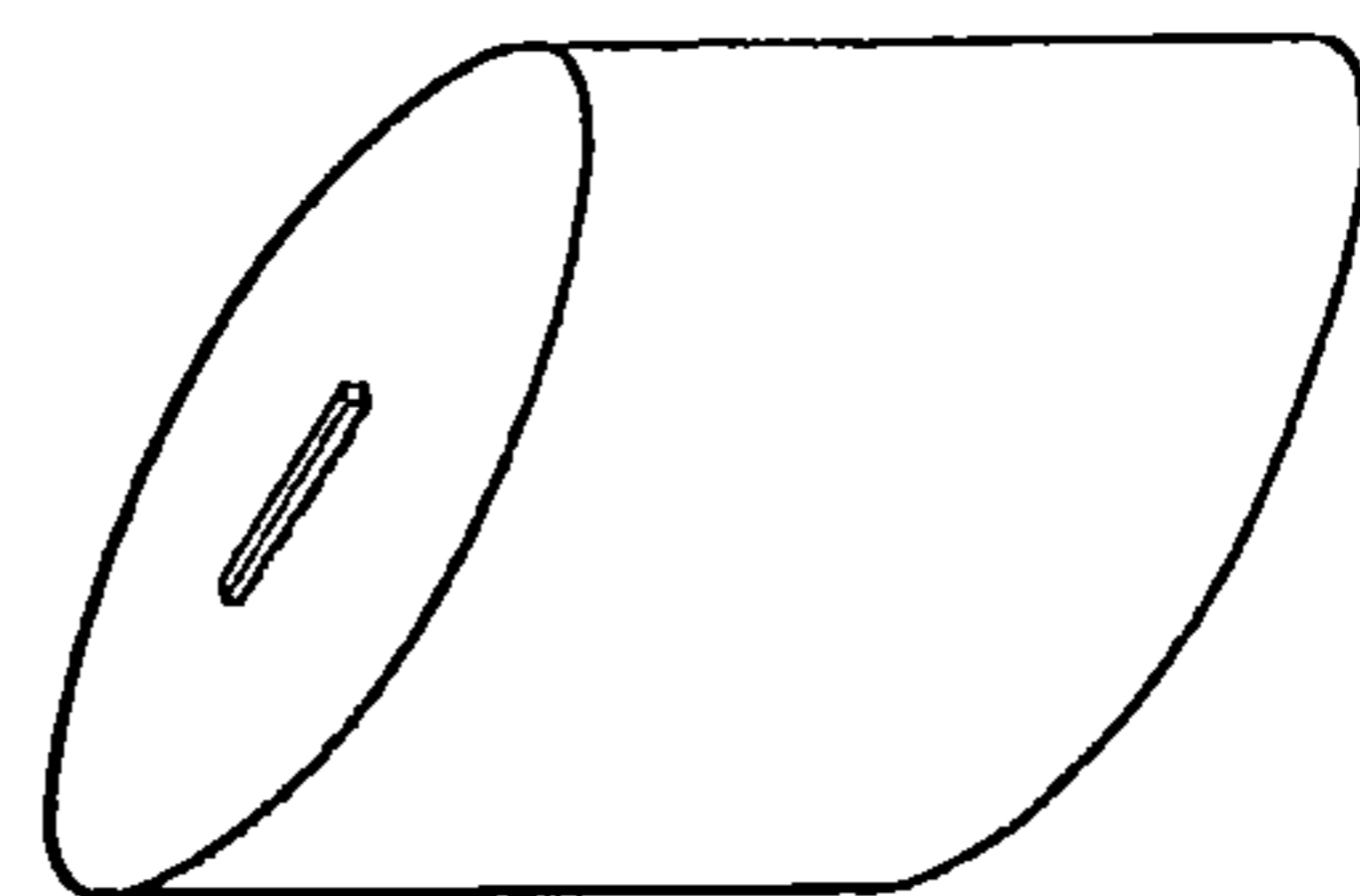

Fig. 44

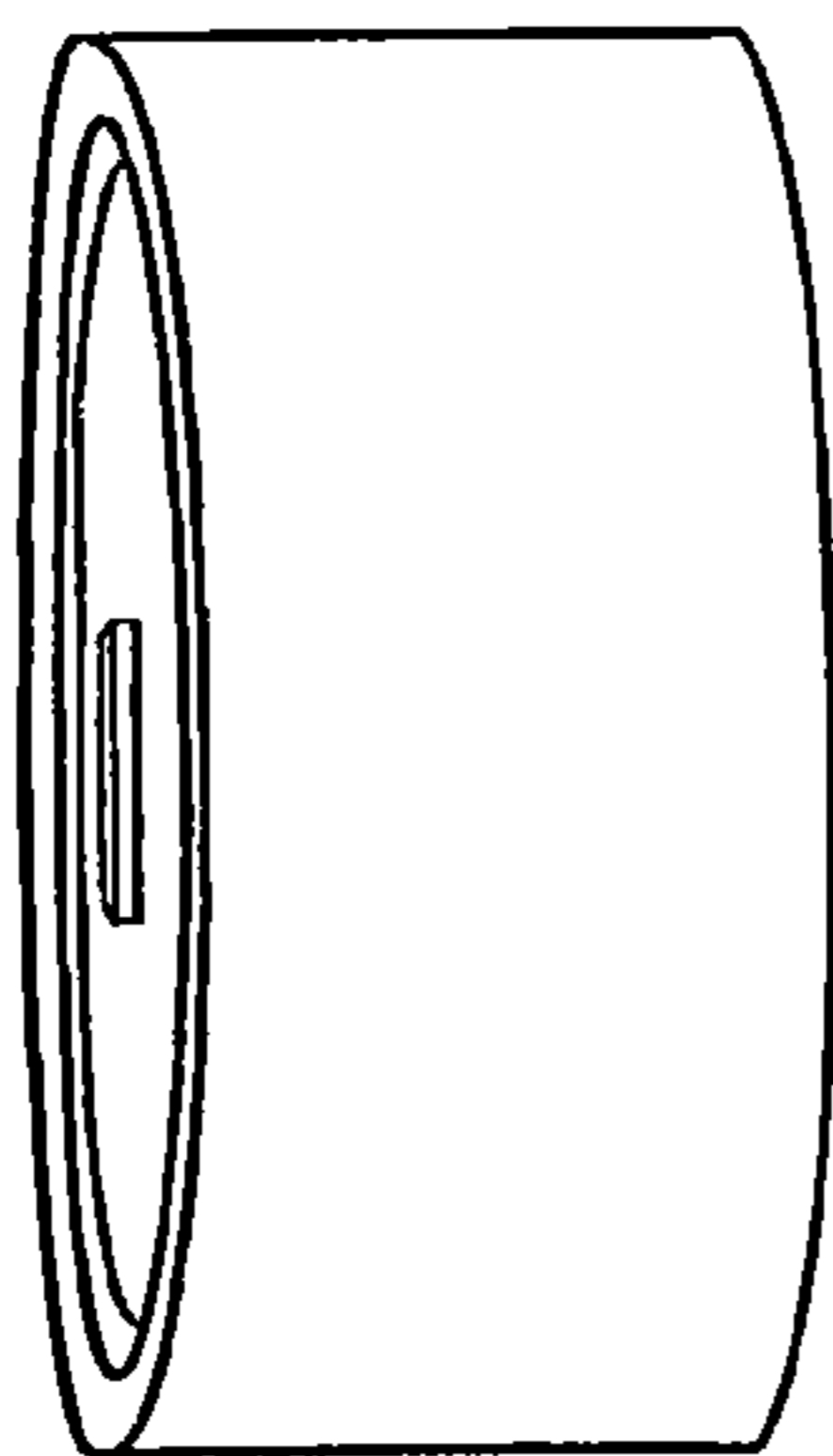

Fig. 46

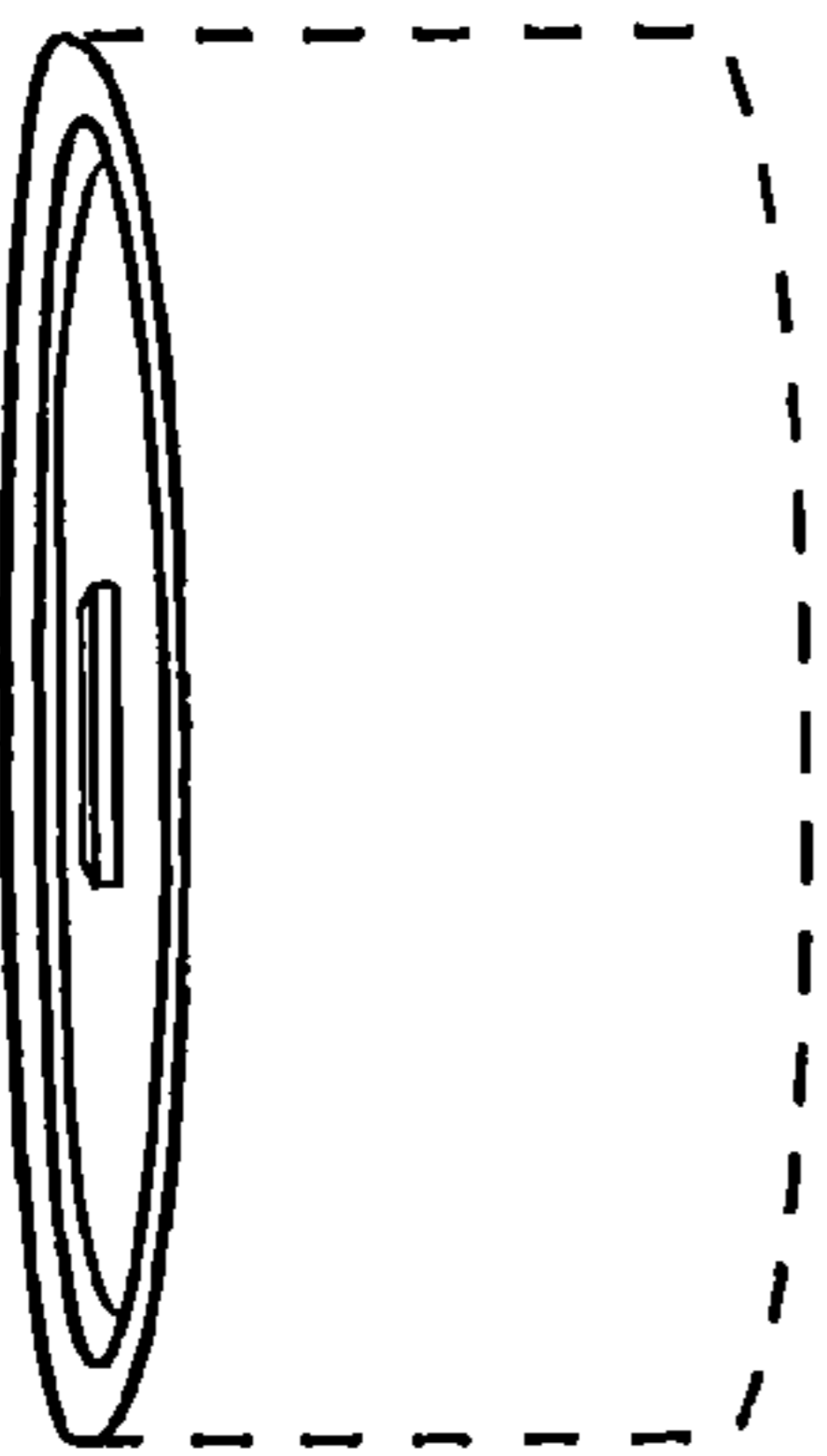

Fig. 47

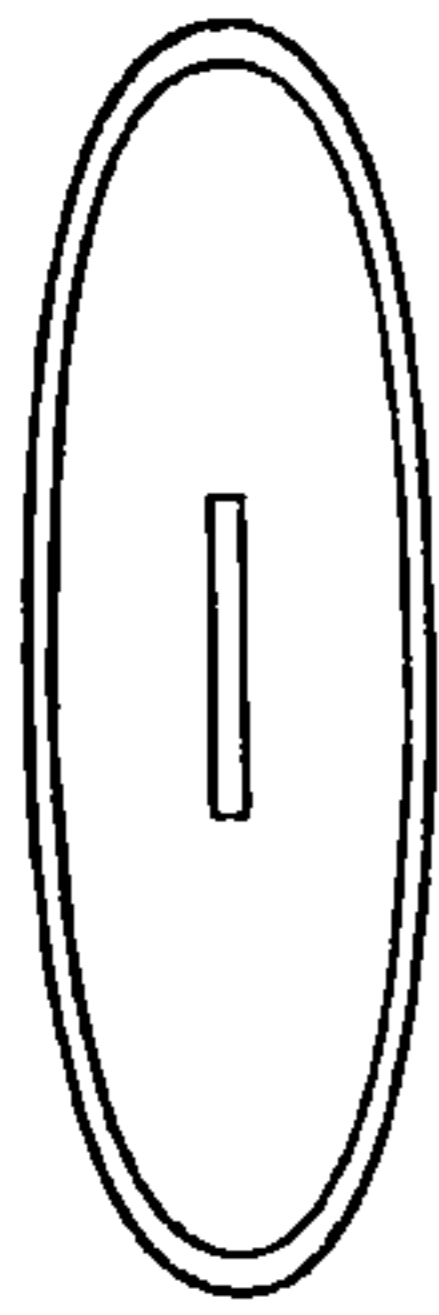

Fig. 48

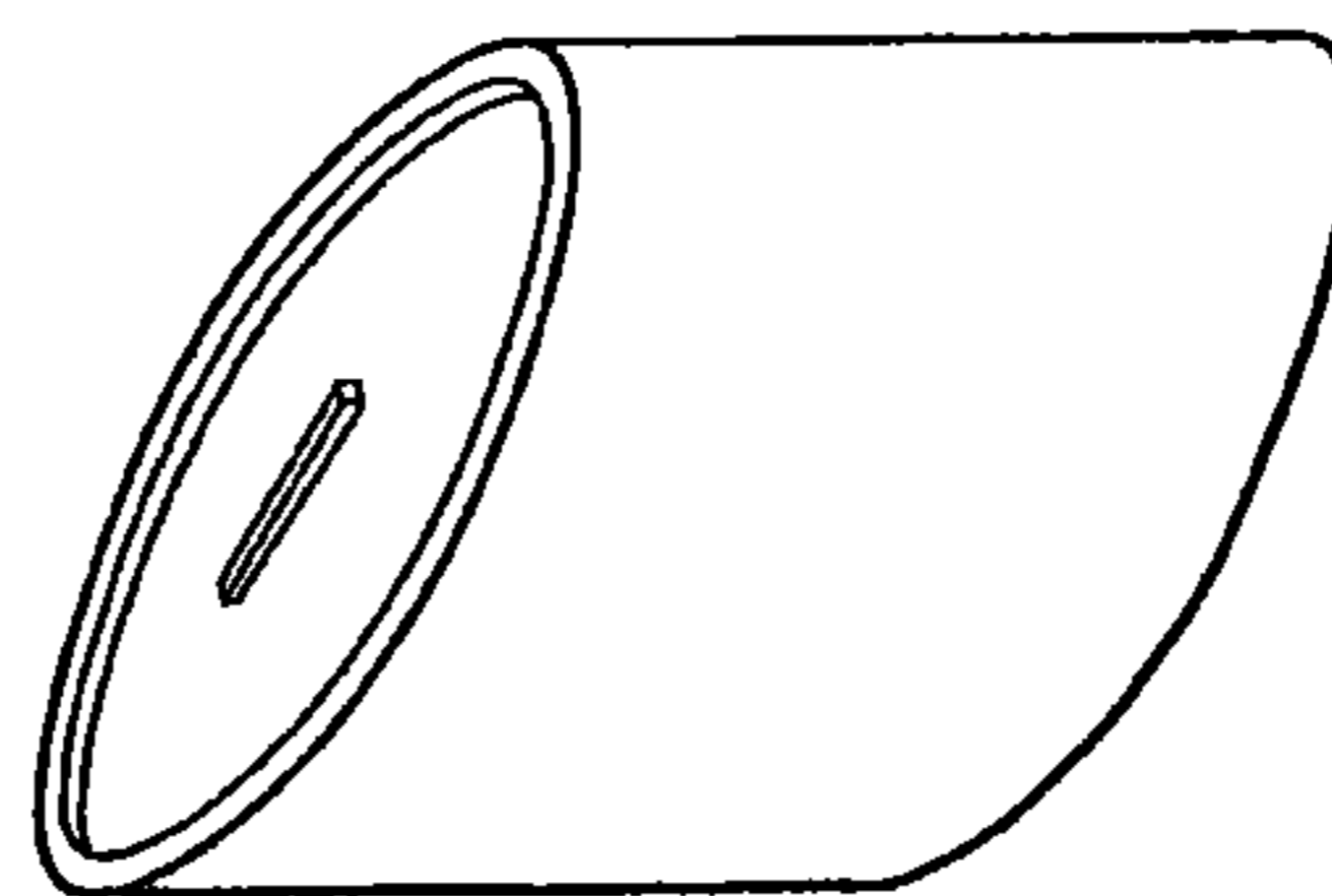

Fig. 49

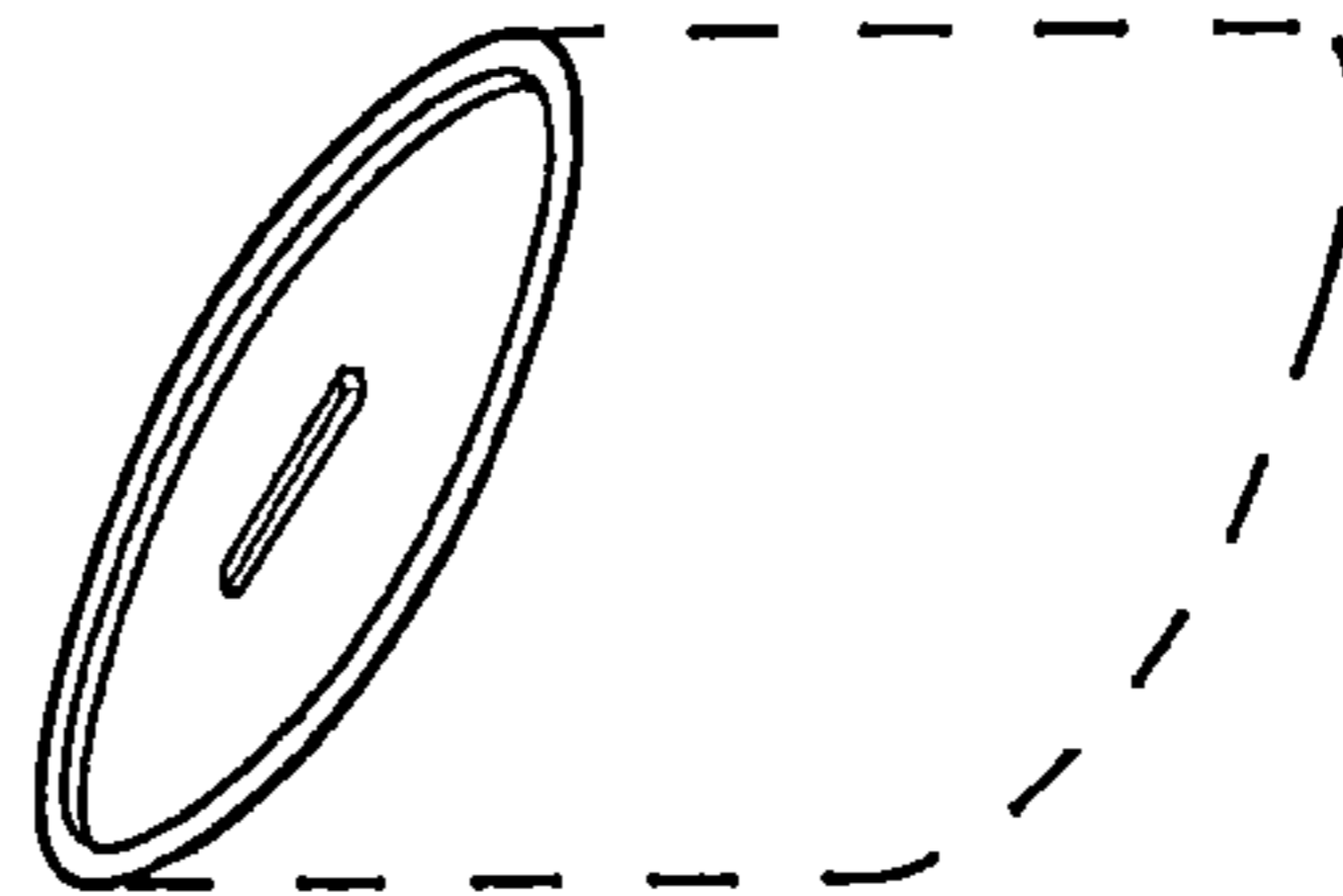

Fig. 50

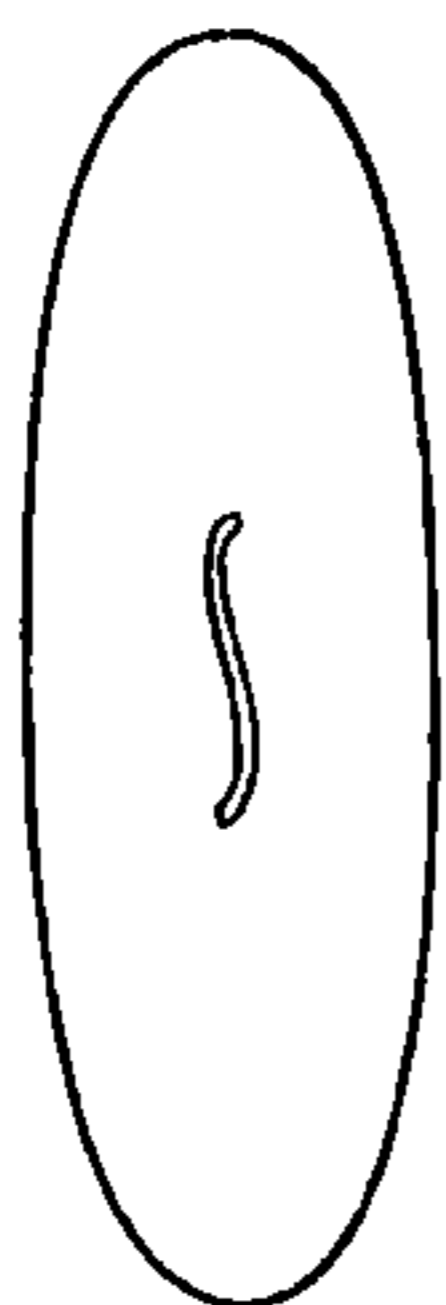

Fig. 53

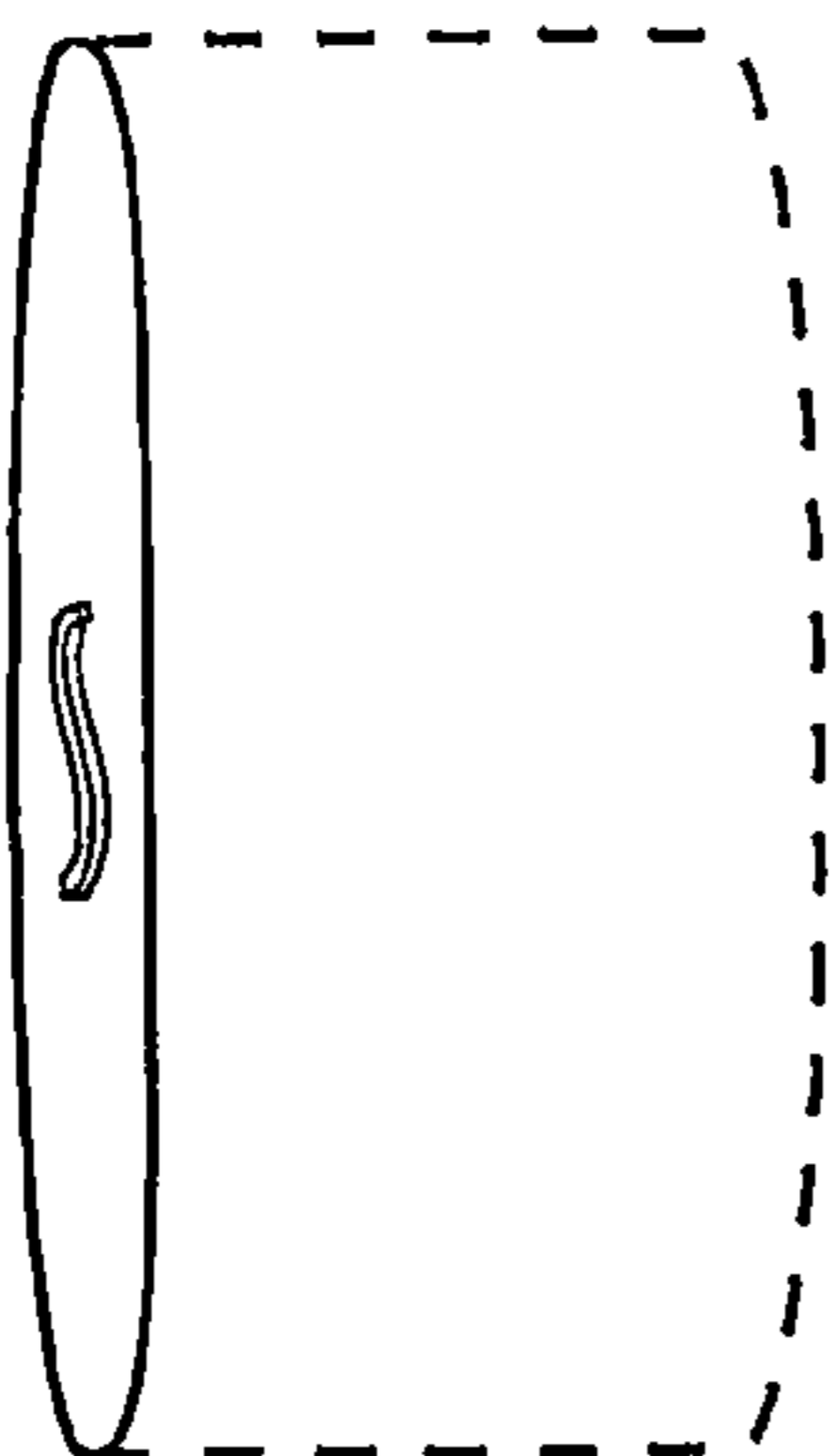

Fig. 52

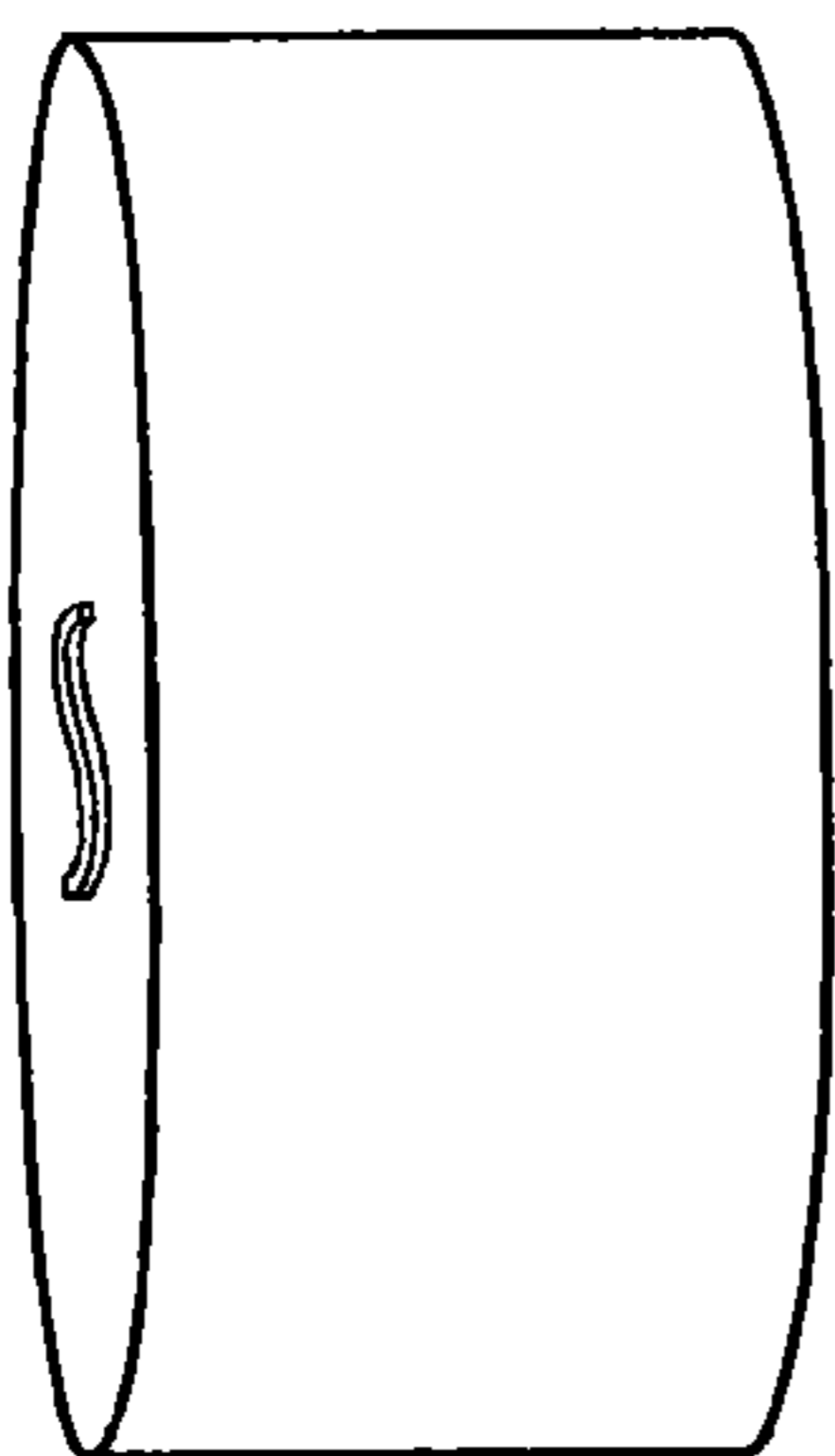

Fig. 51

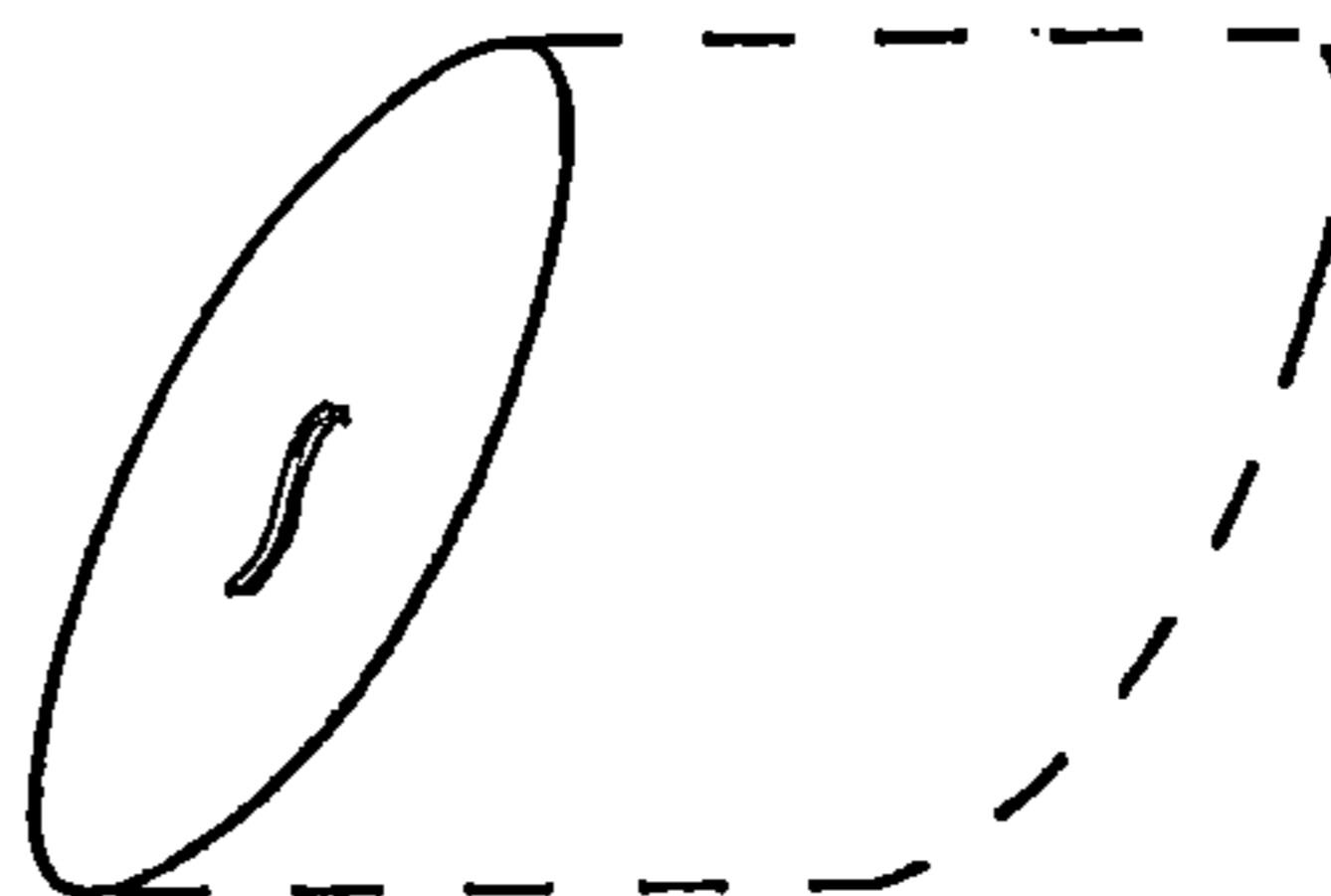

Fig. 55

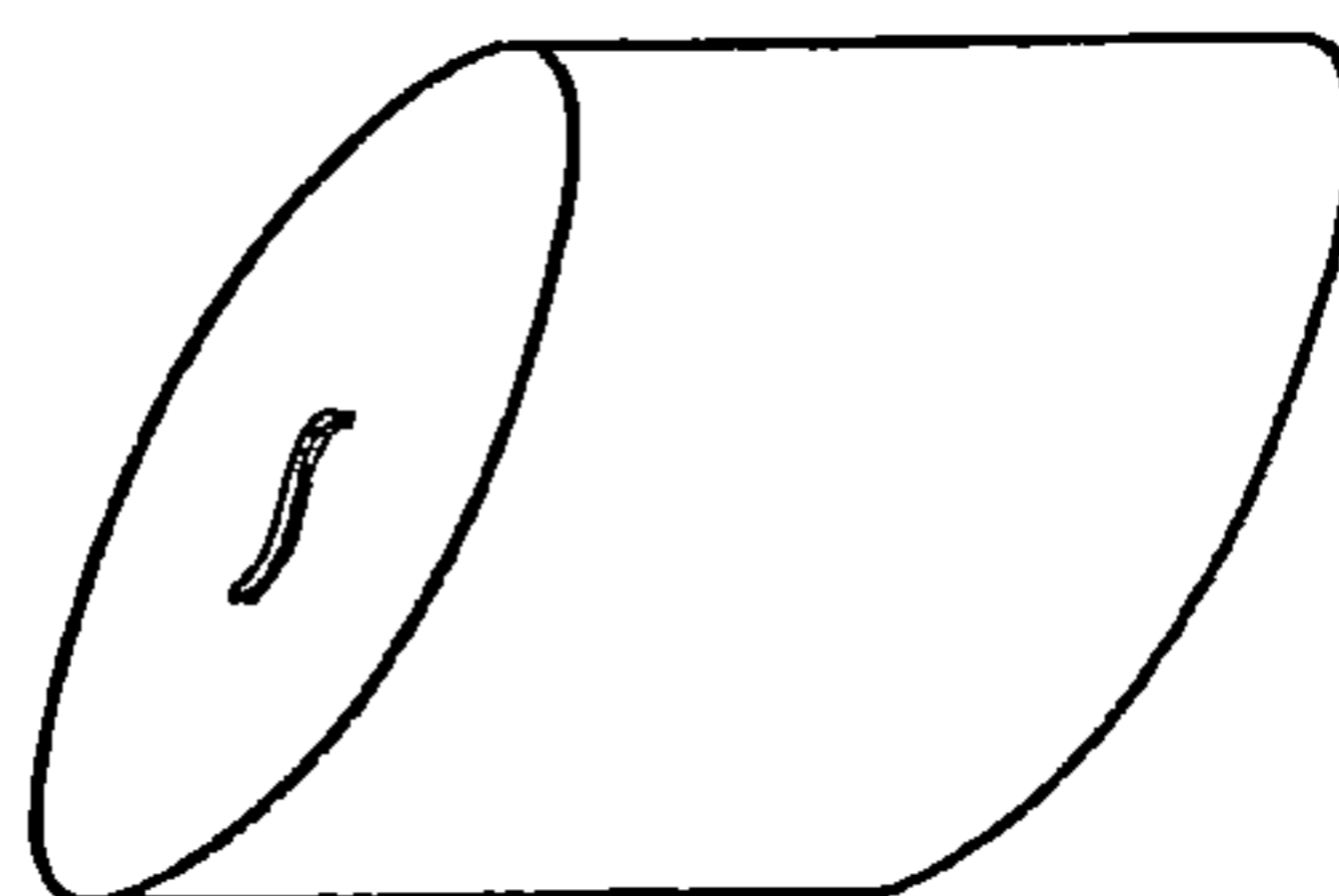

Fig. 54

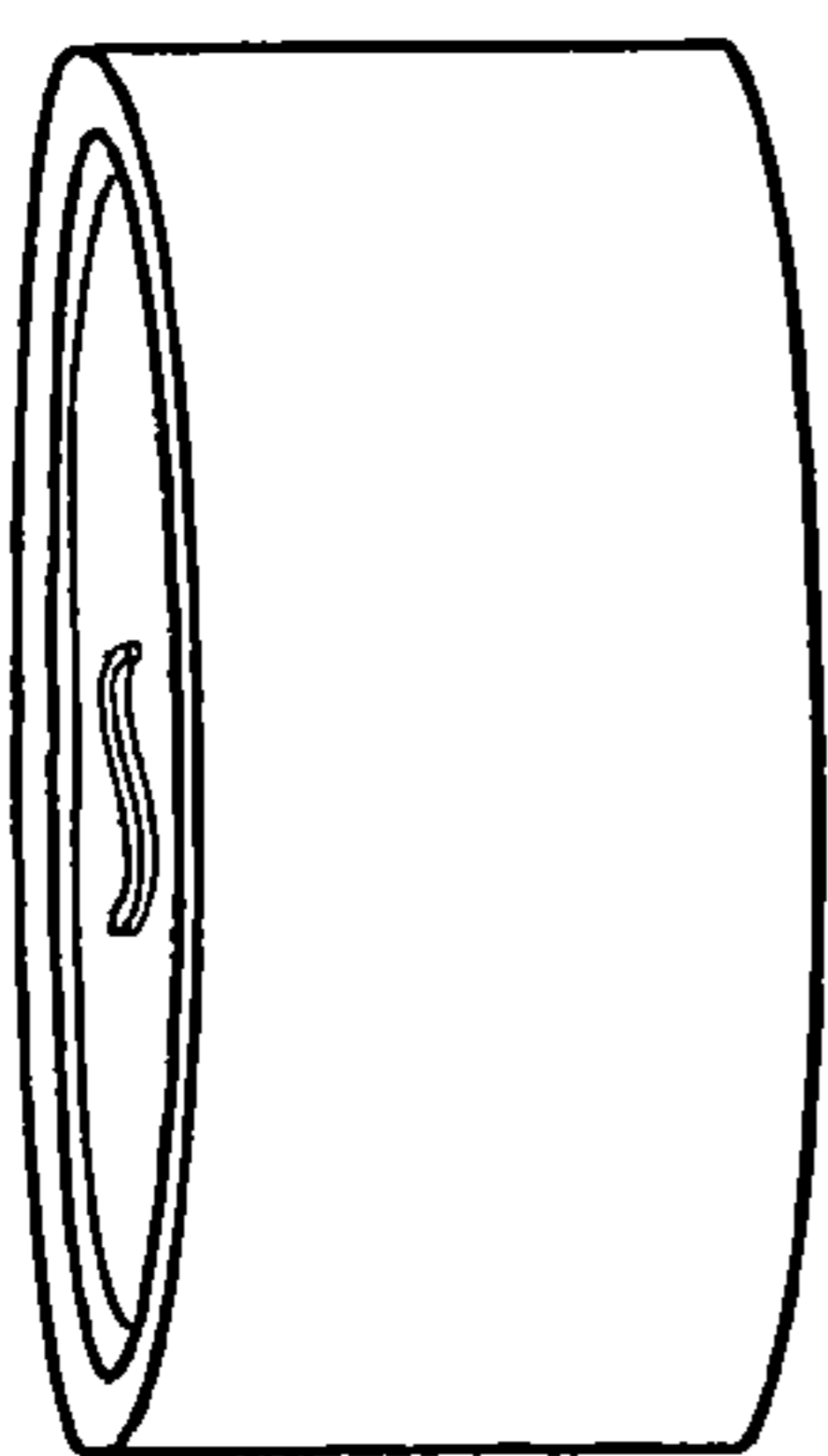

Fig. 56

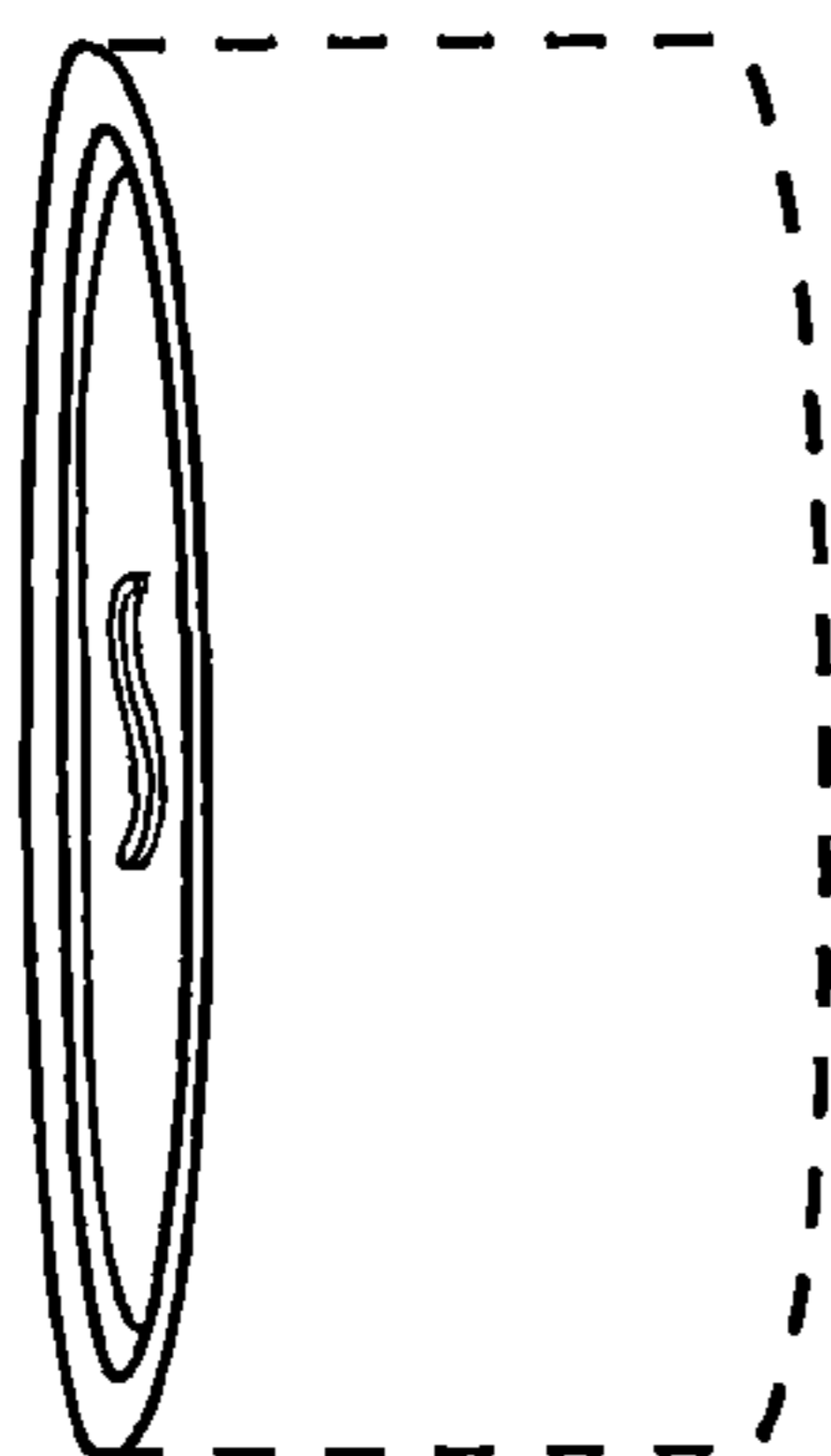

Fig. 57

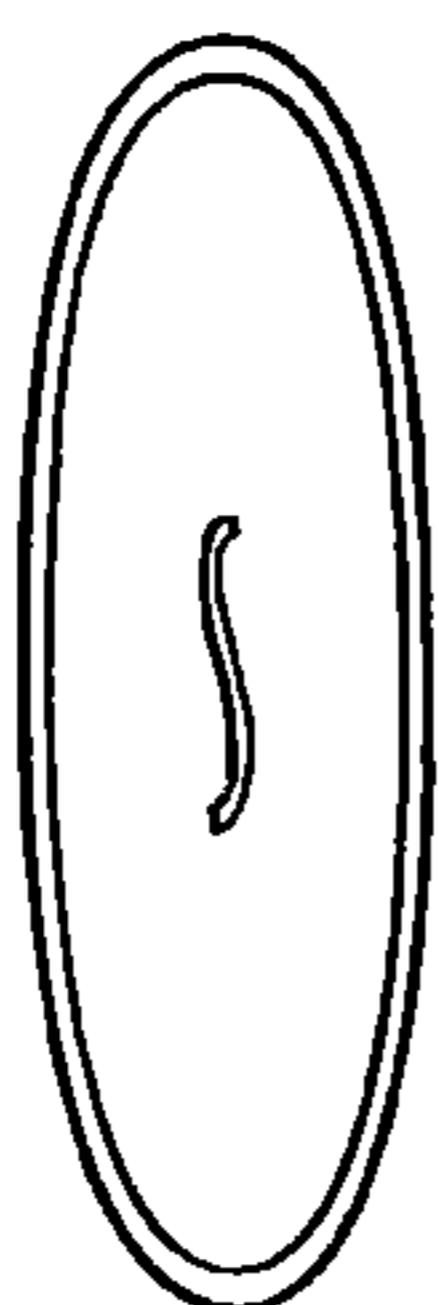

Fig. 58

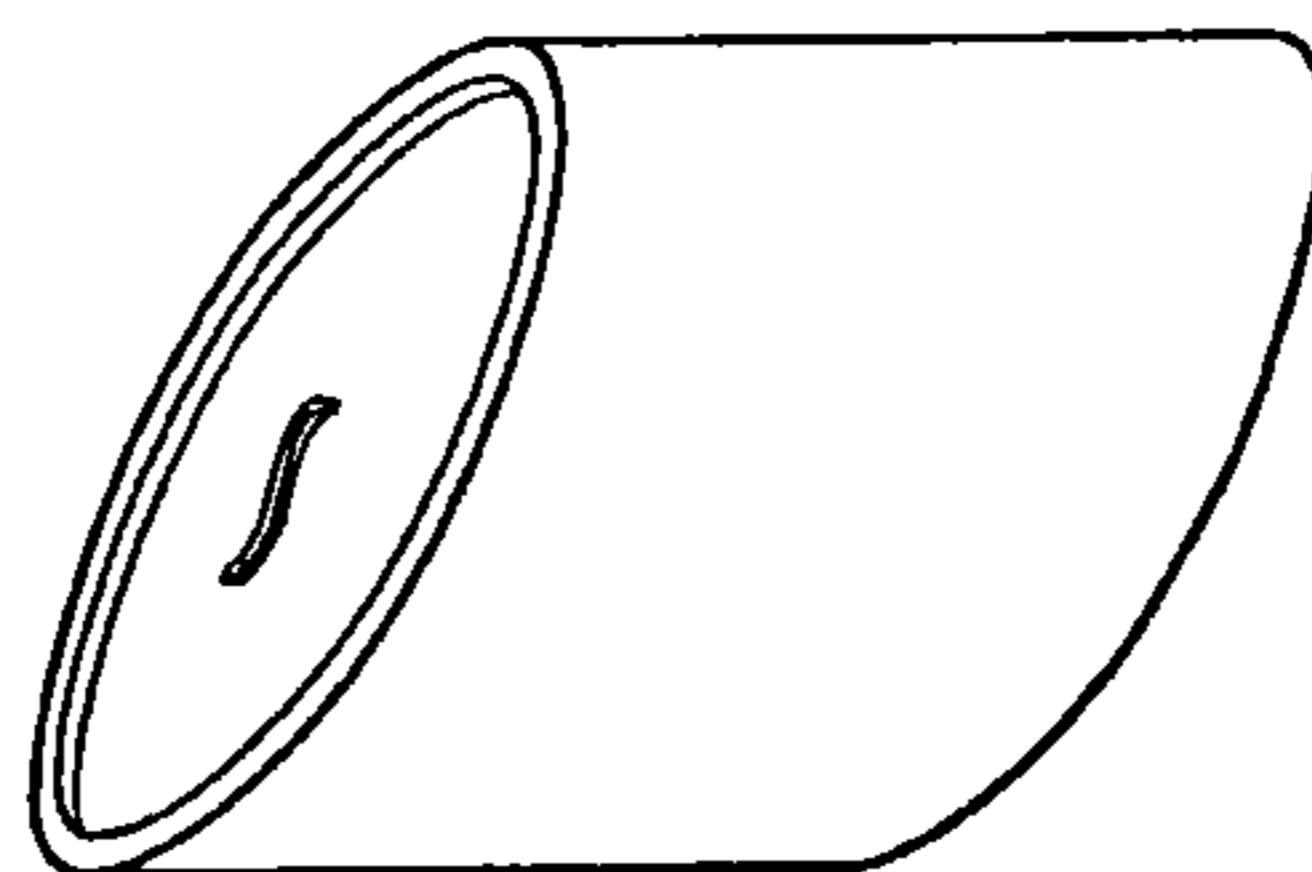

Fig. 59



Fig. 60

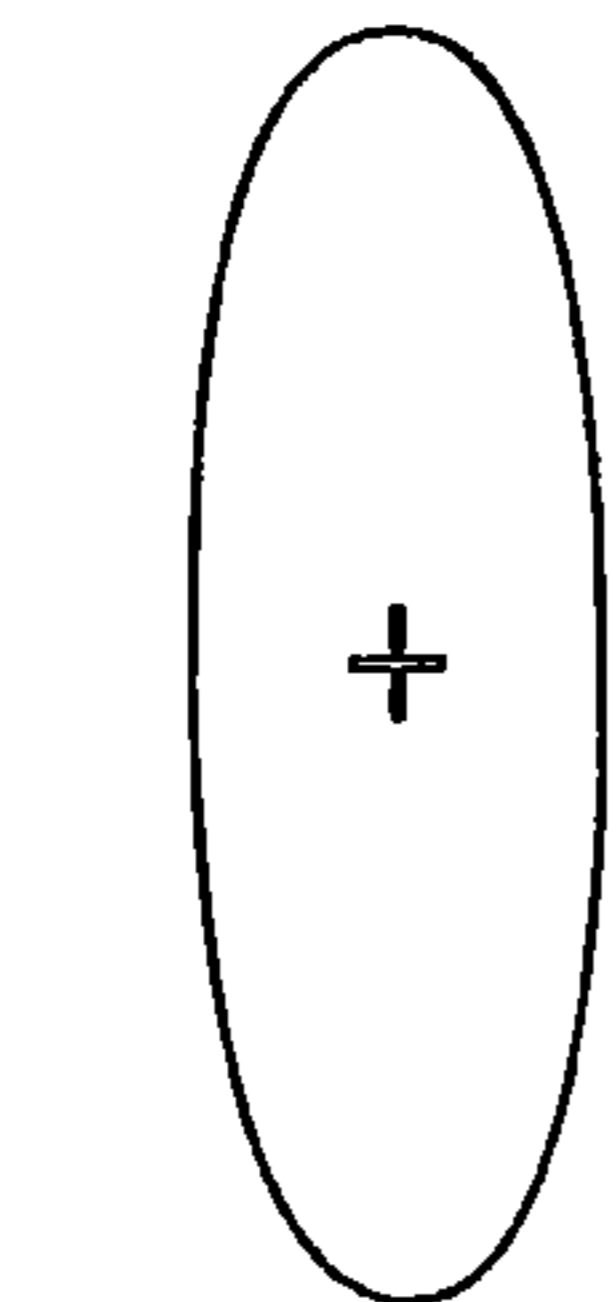

Fig. 63

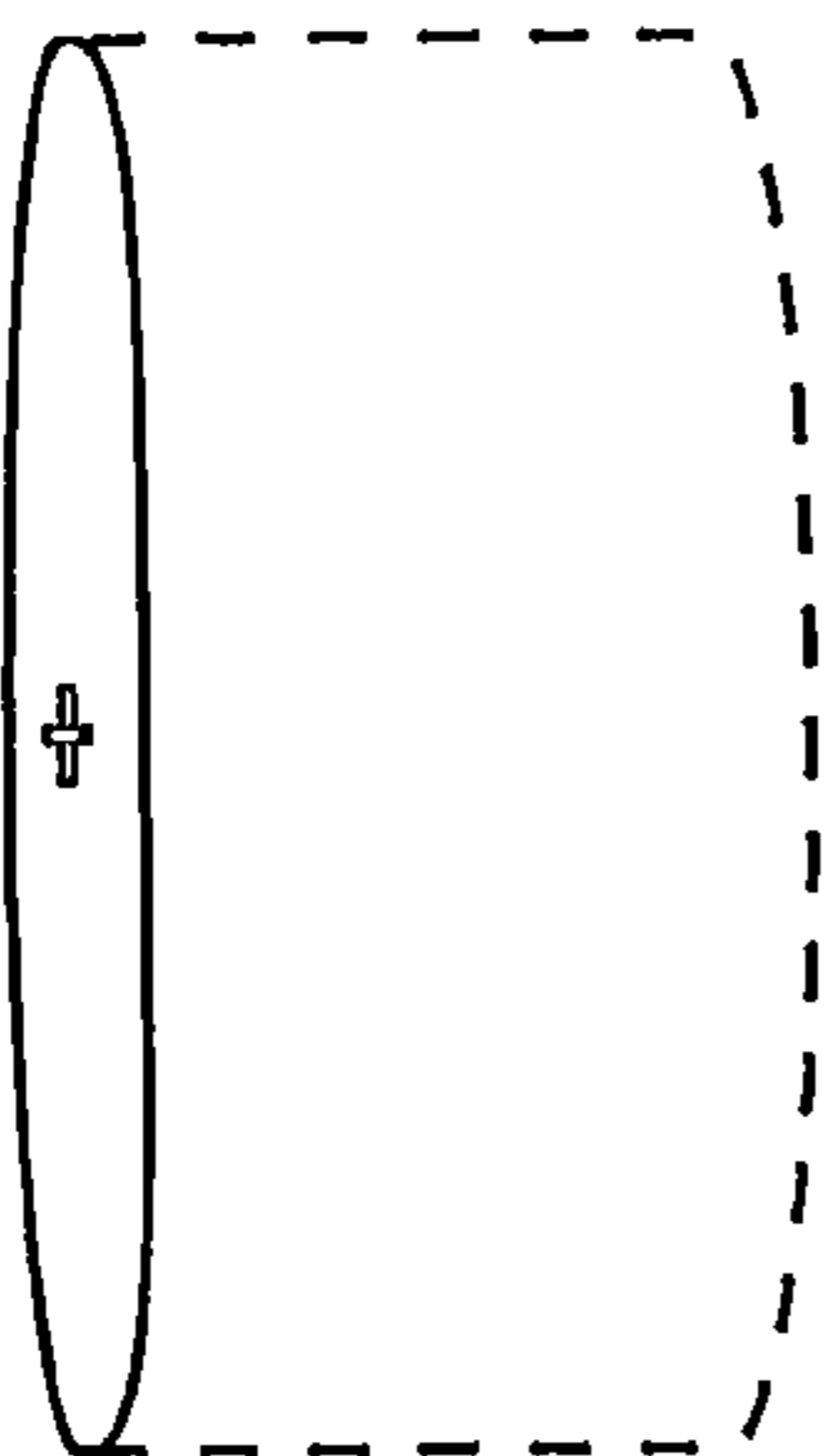

Fig. 62

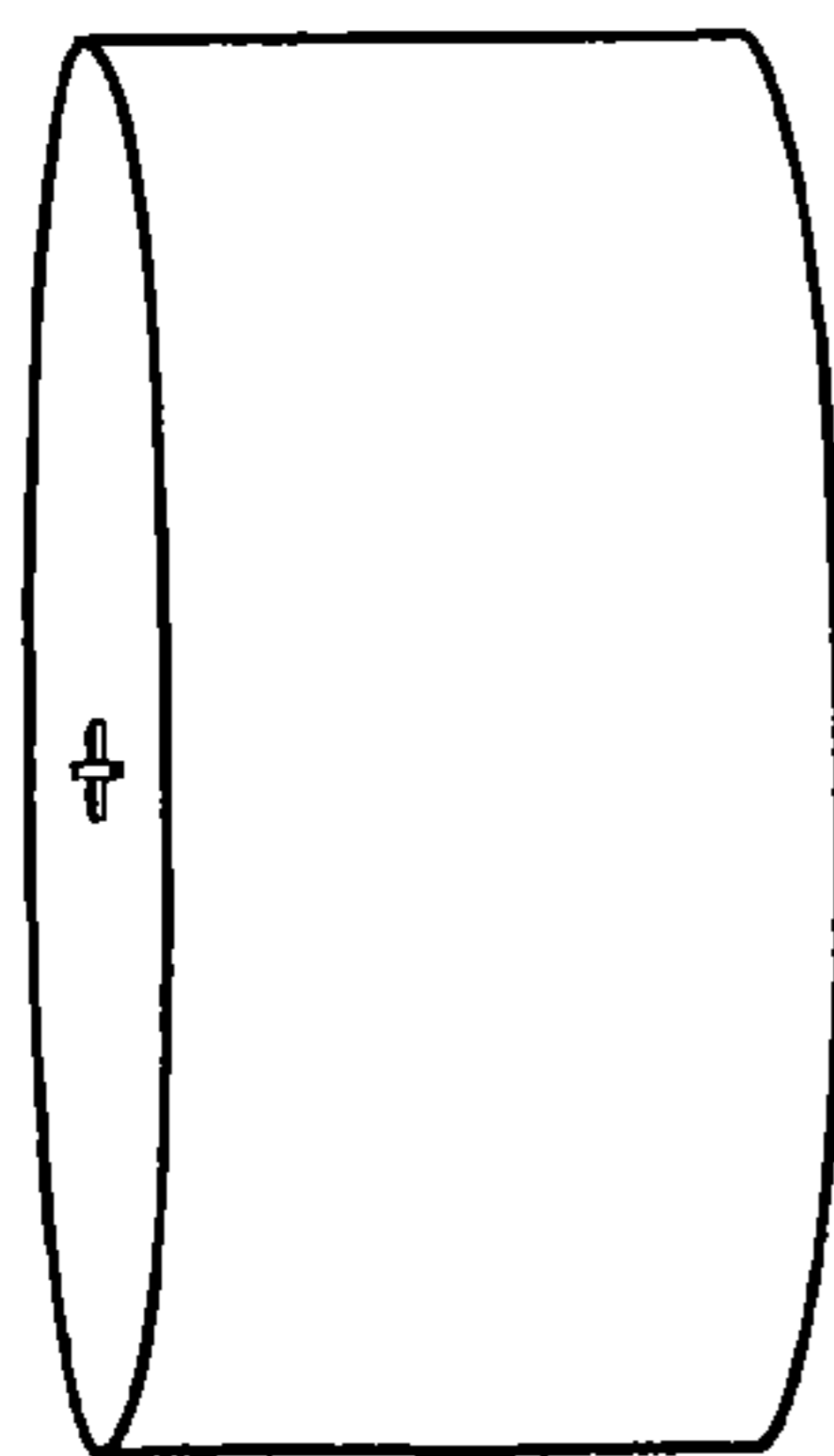

Fig. 61

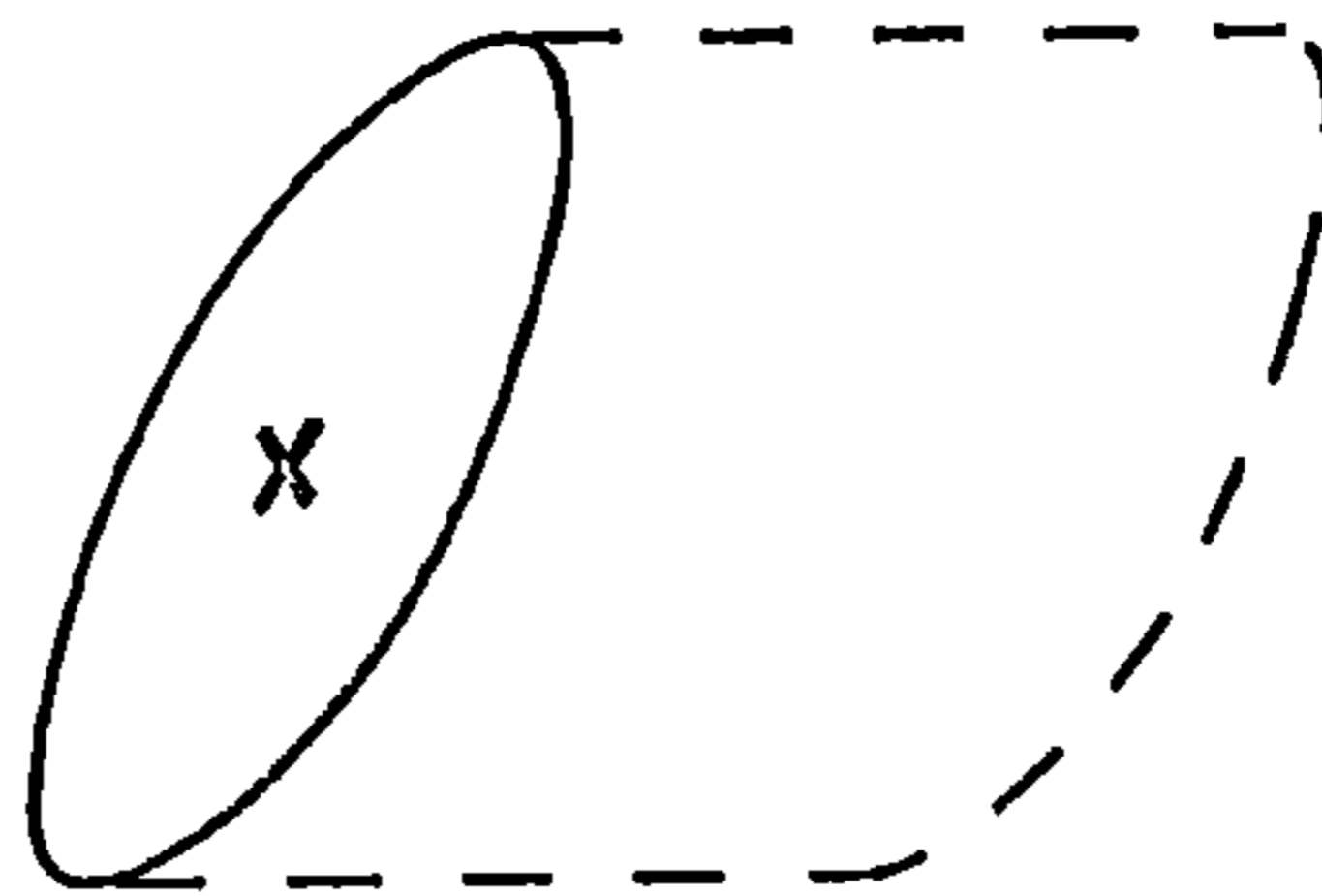

Fig. 65

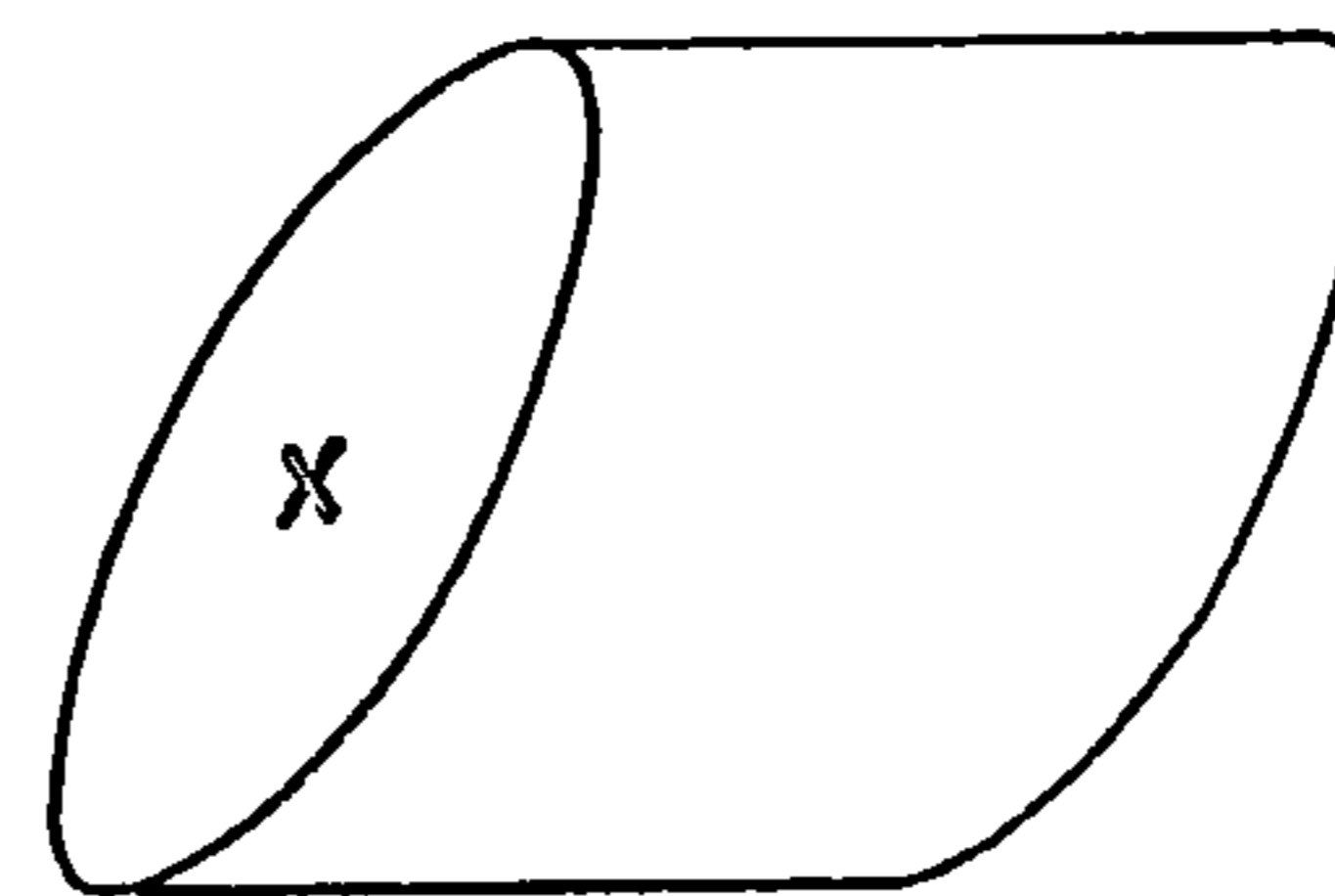

Fig. 64

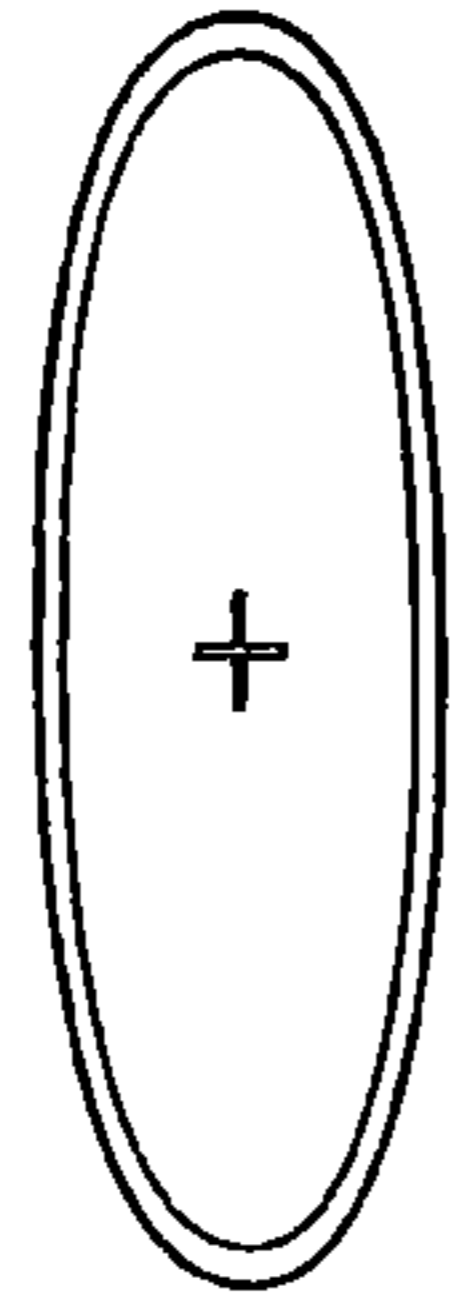

Fig. 68

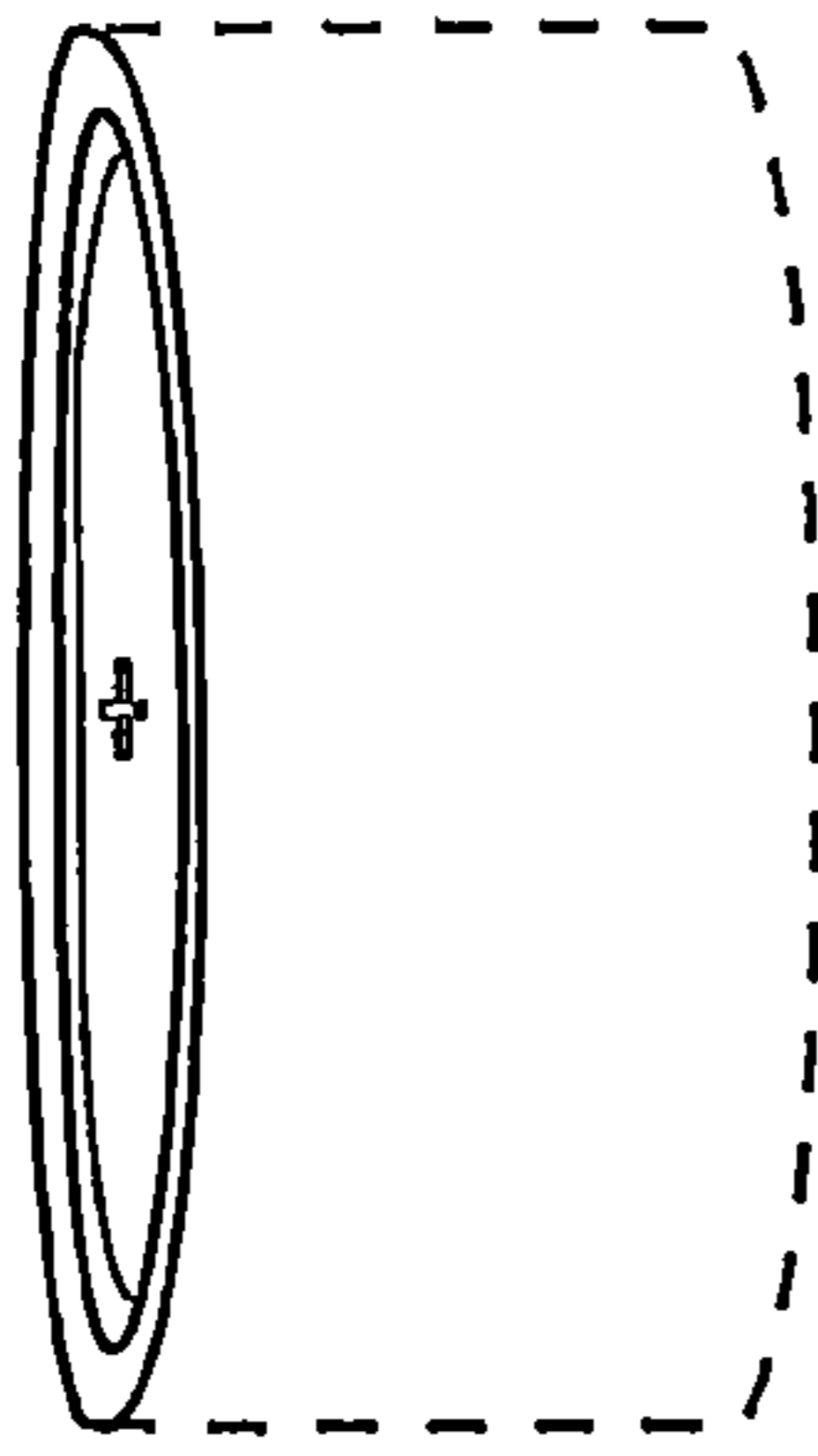

Fig. 67

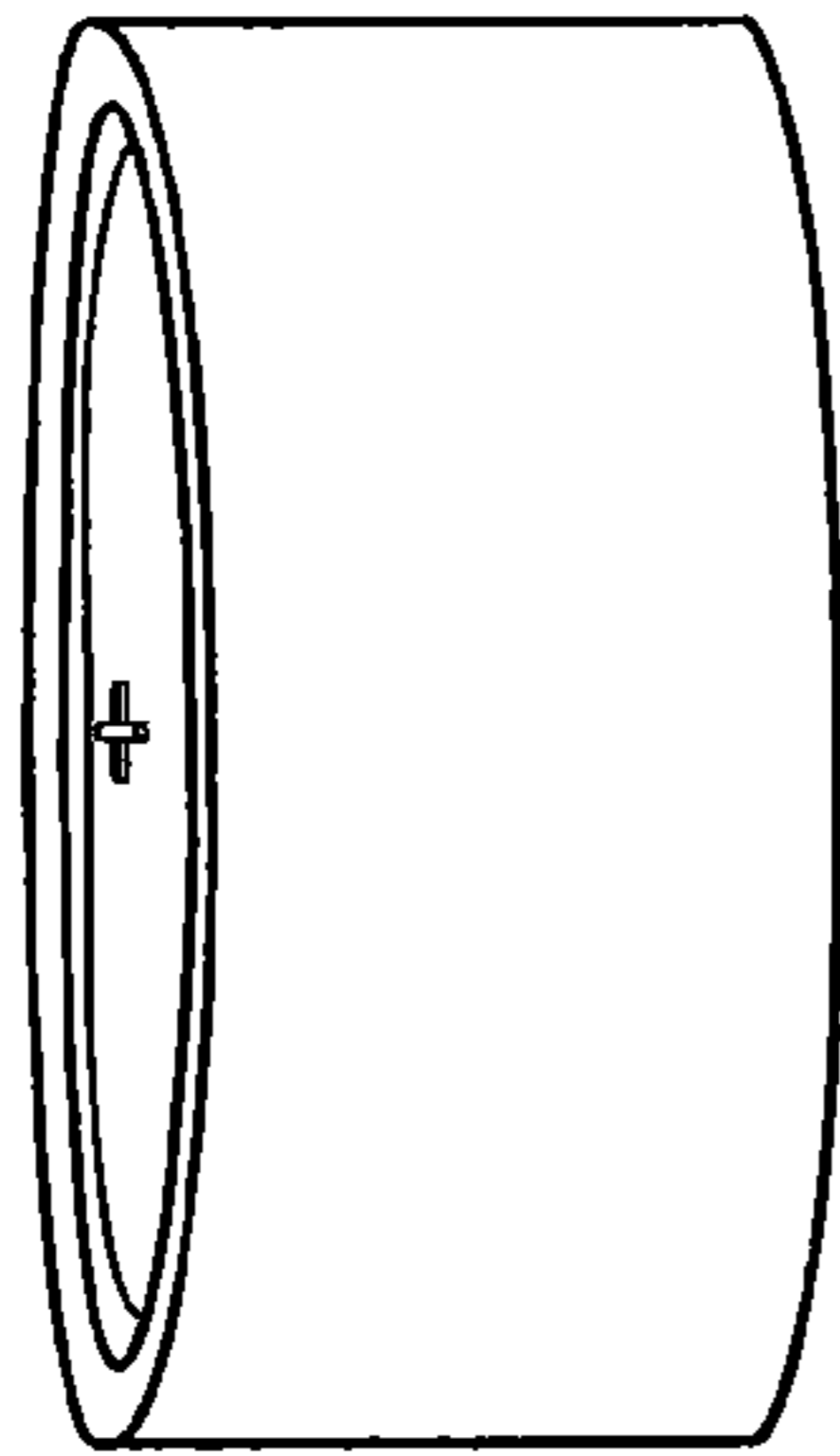

Fig. 66

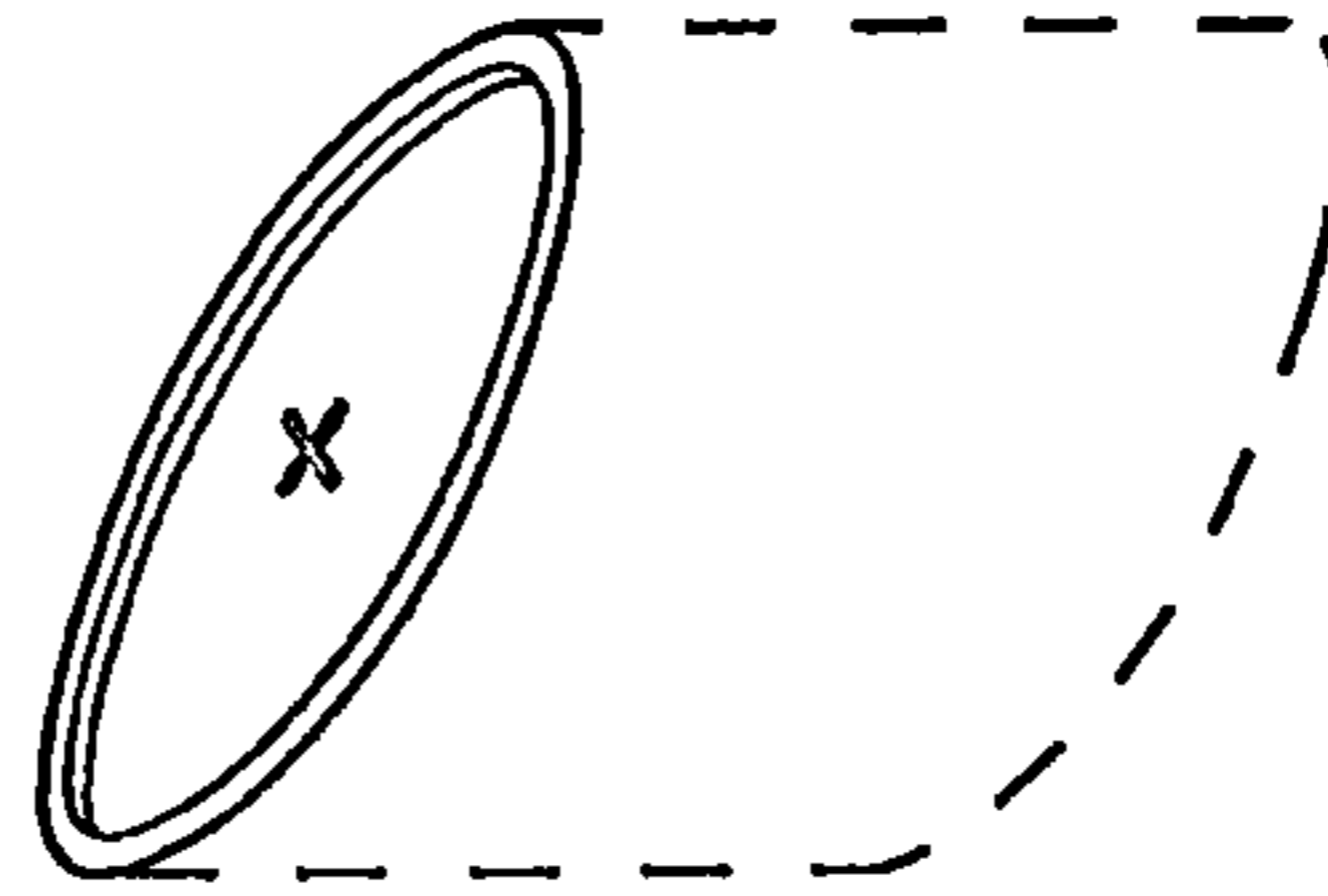

Fig. 70

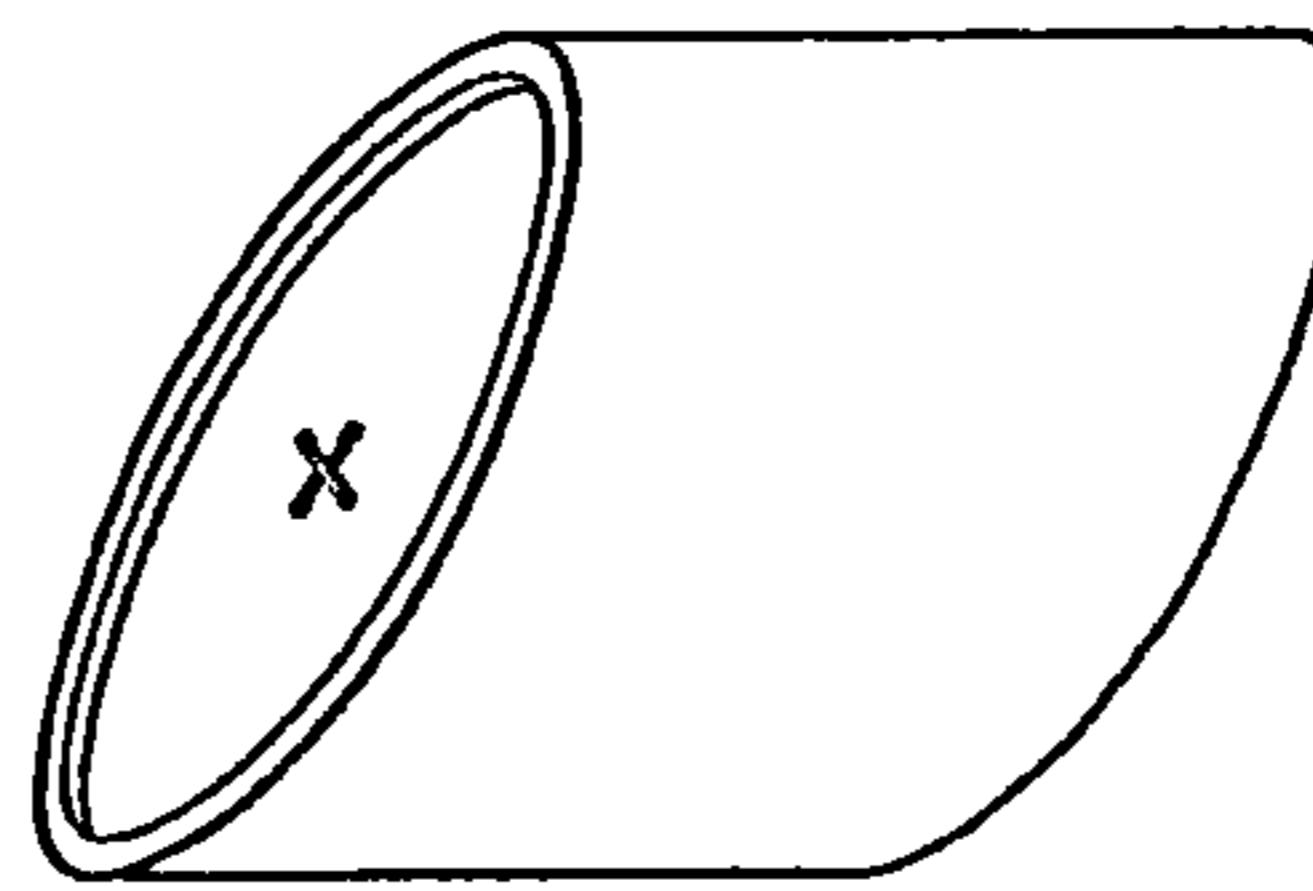

Fig. 69

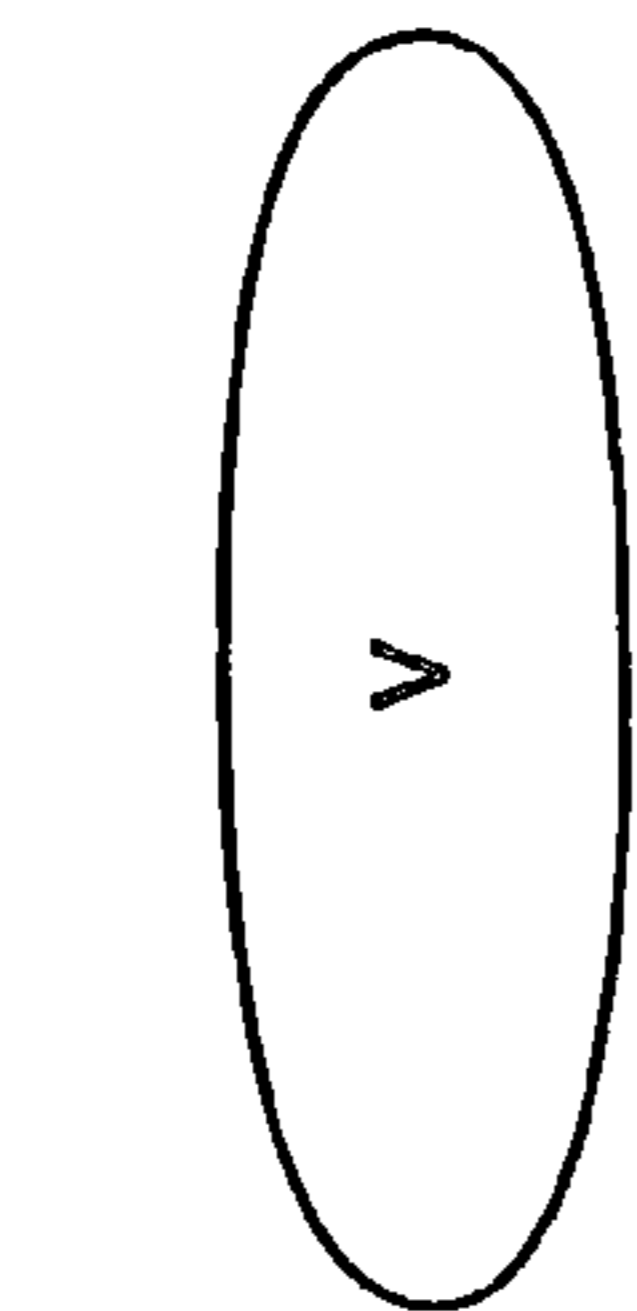

Fig. 73

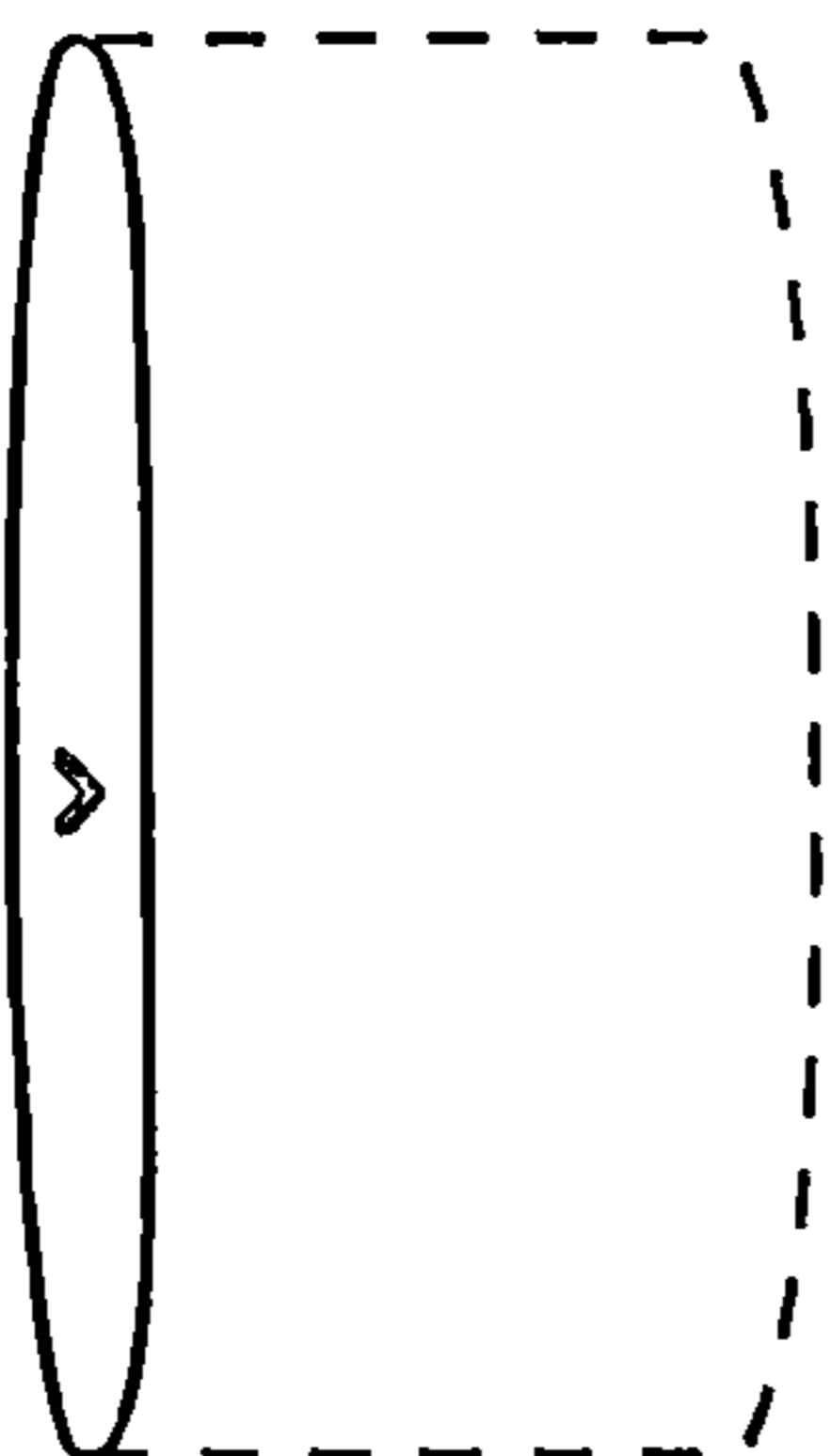

Fig. 72

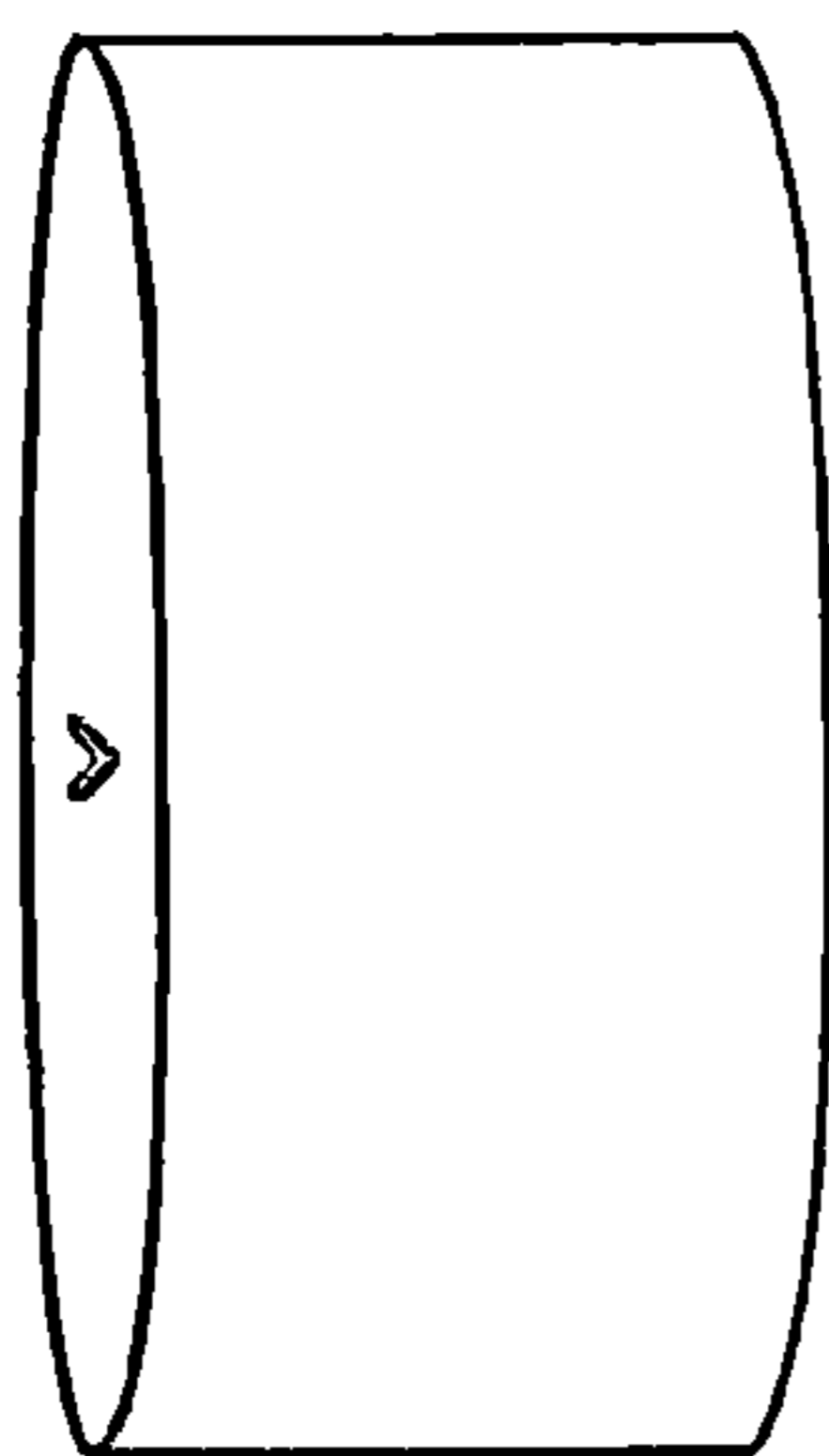

Fig. 71

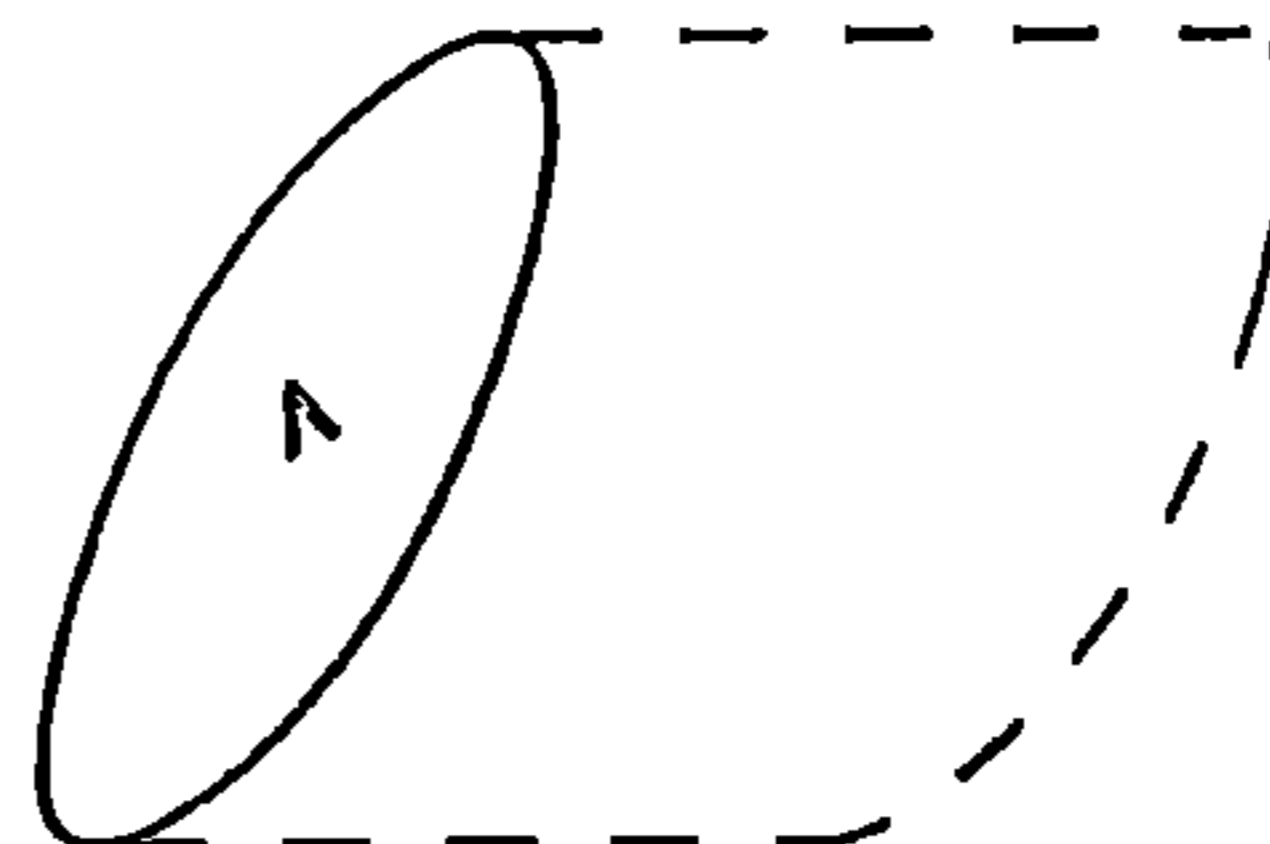

Fig. 75

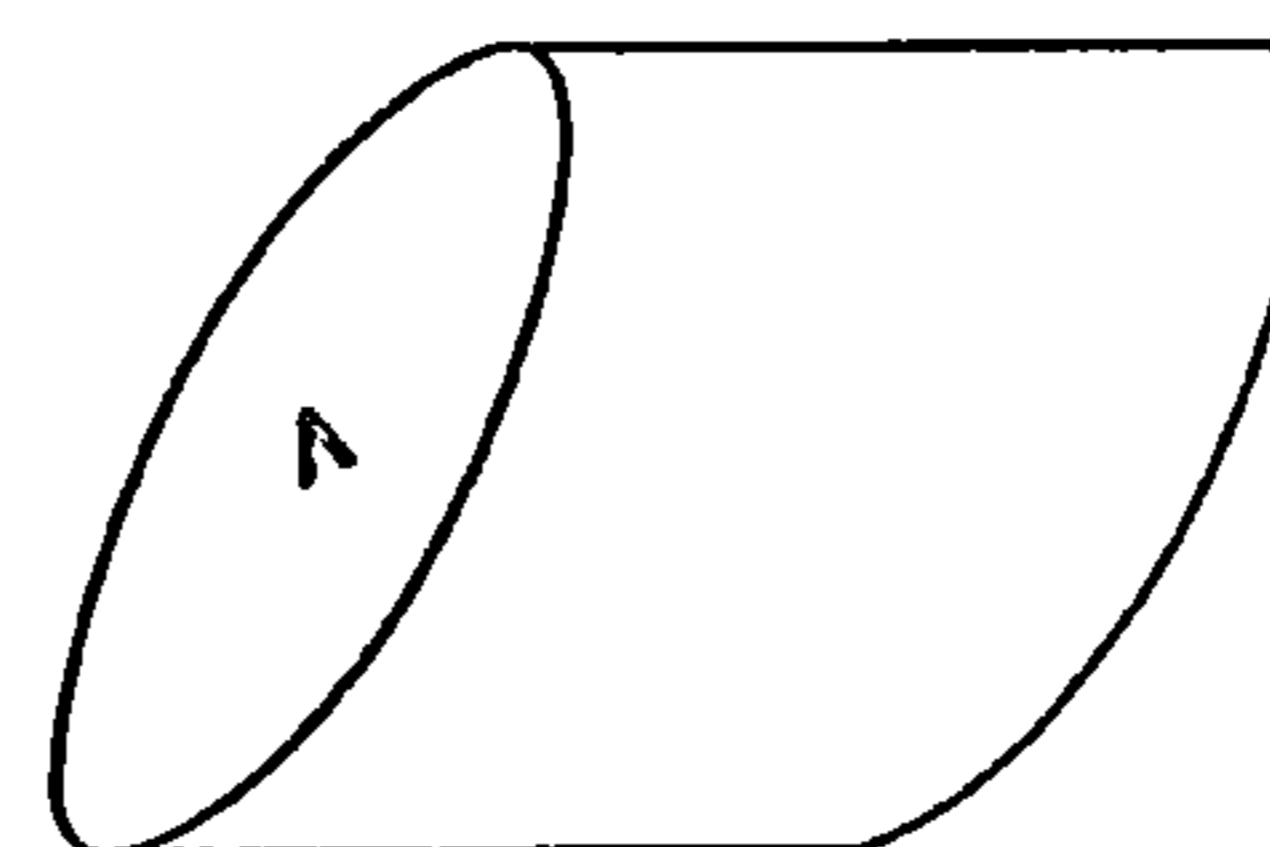

Fig. 74

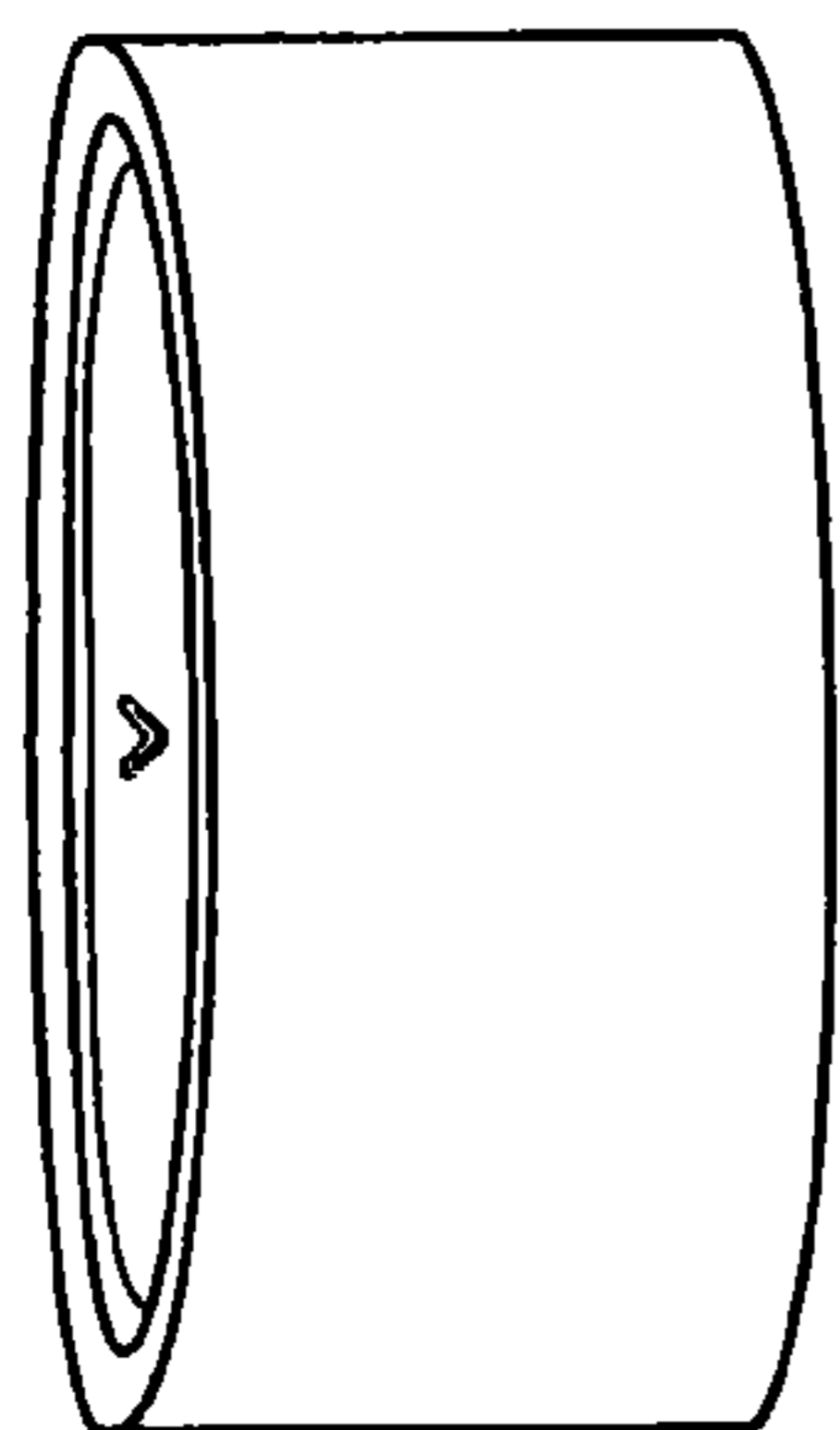

Fig. 76

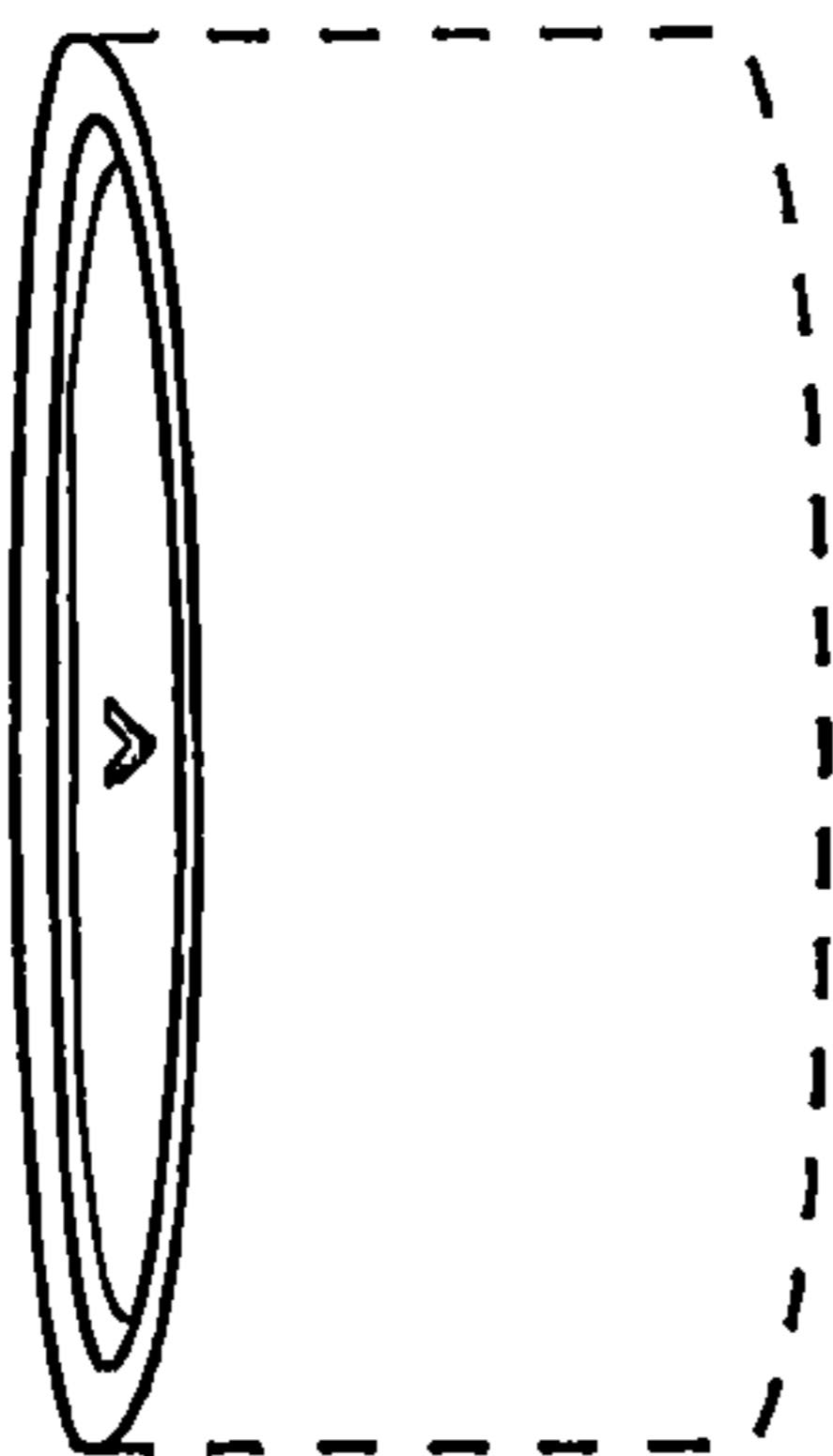

Fig. 77

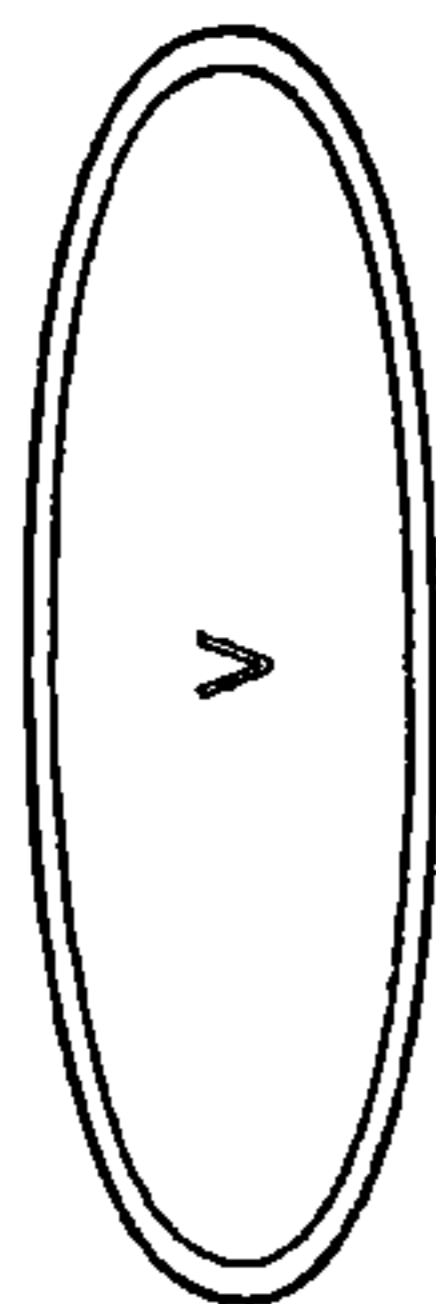

Fig. 78

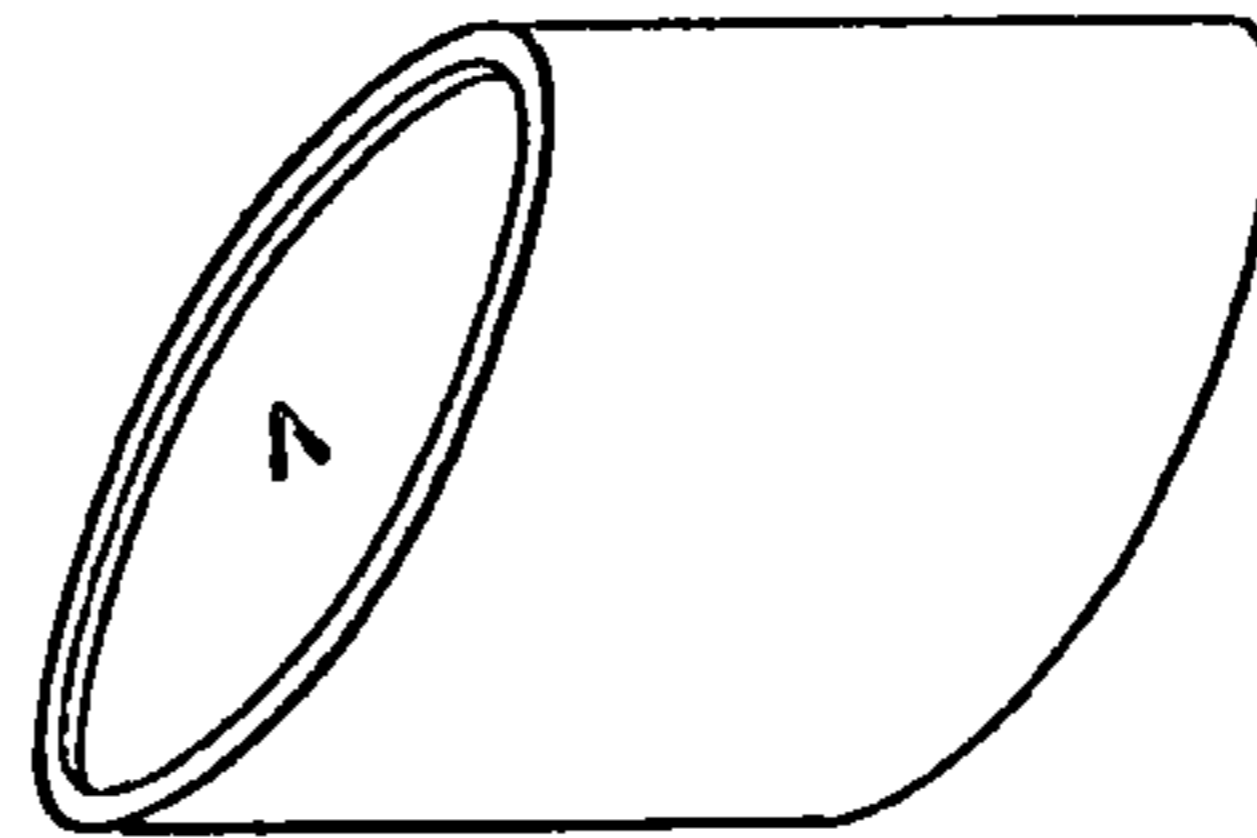

Fig. 79



Fig. 80

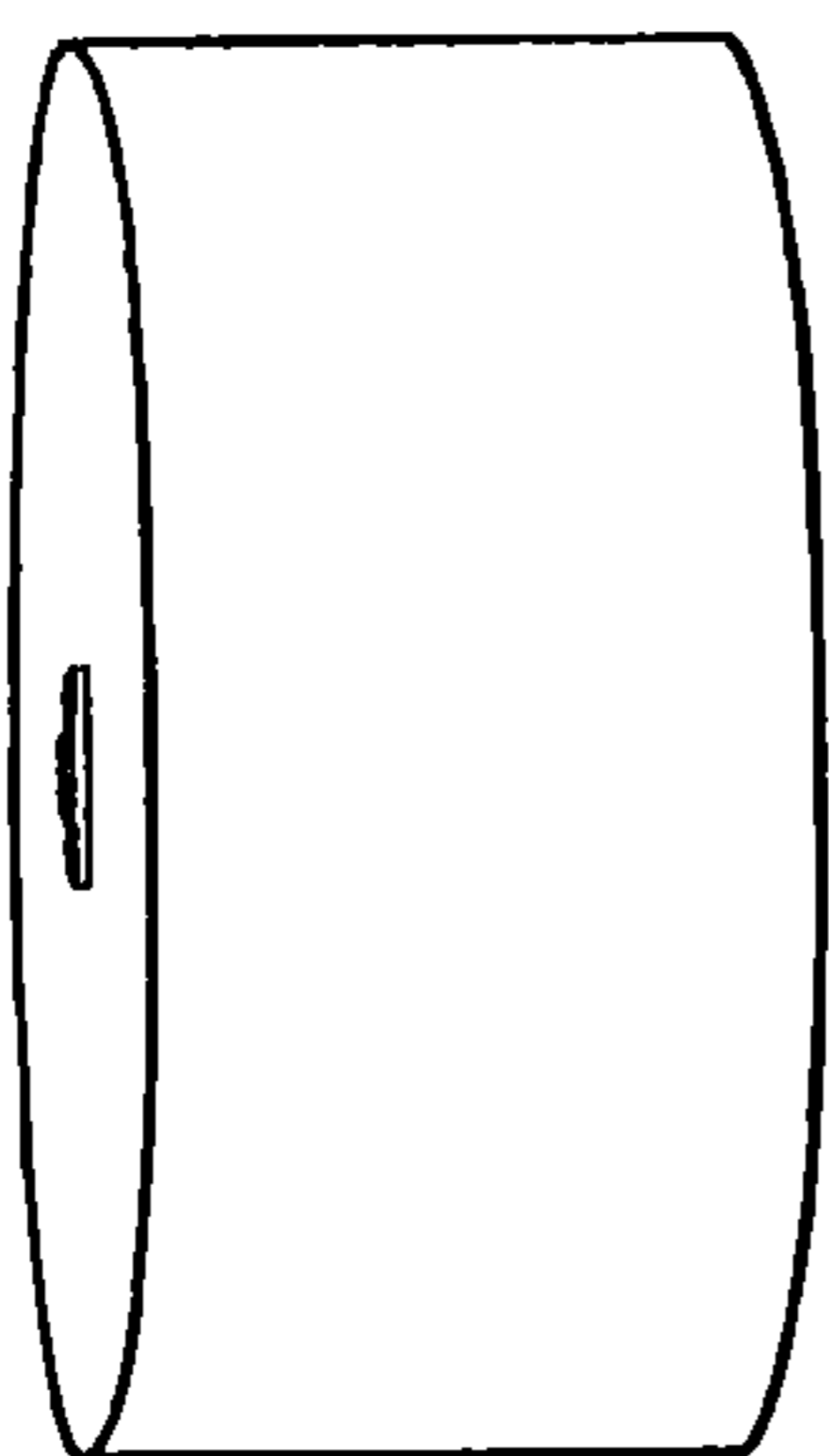

Fig. 81

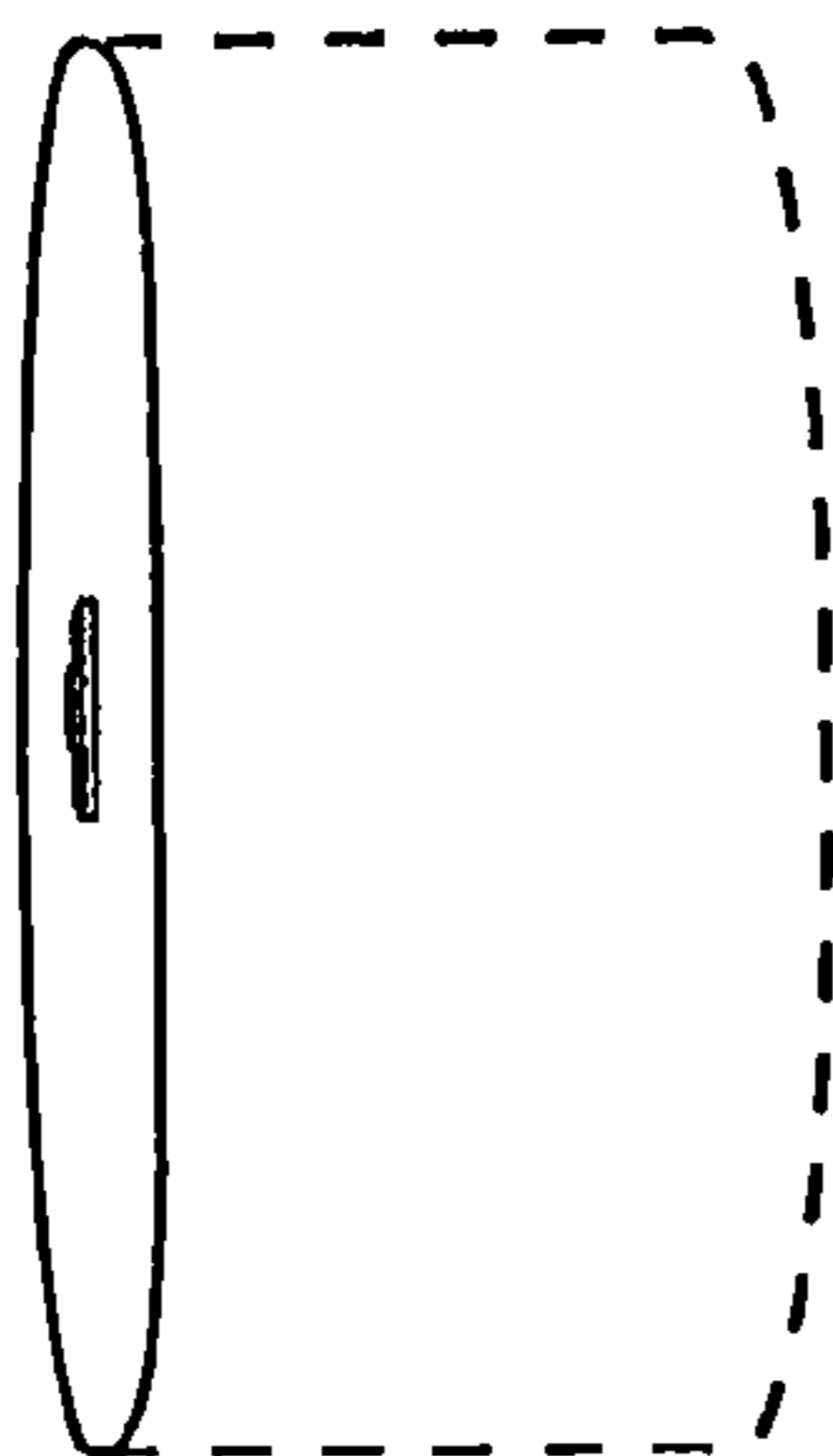

Fig. 82

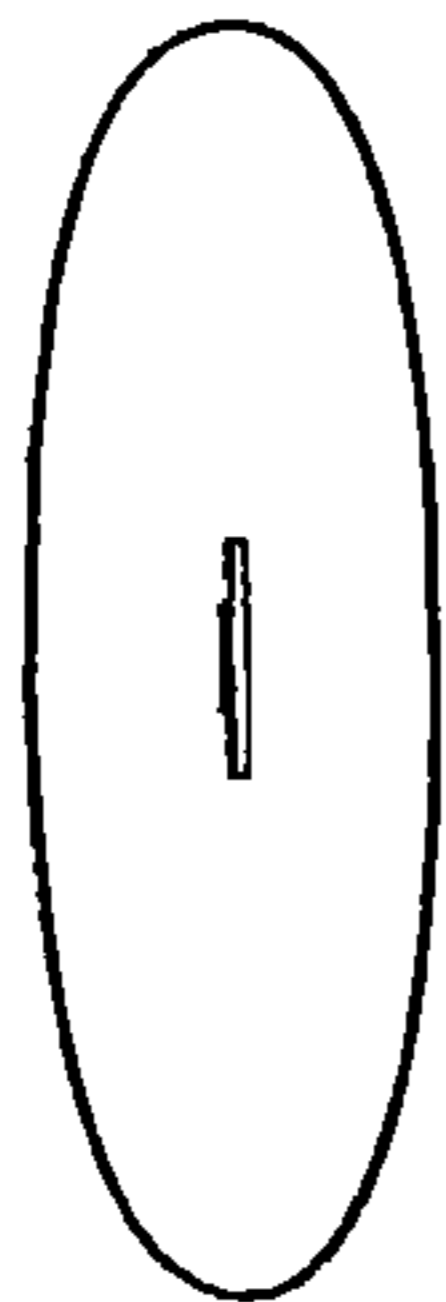

Fig. 83

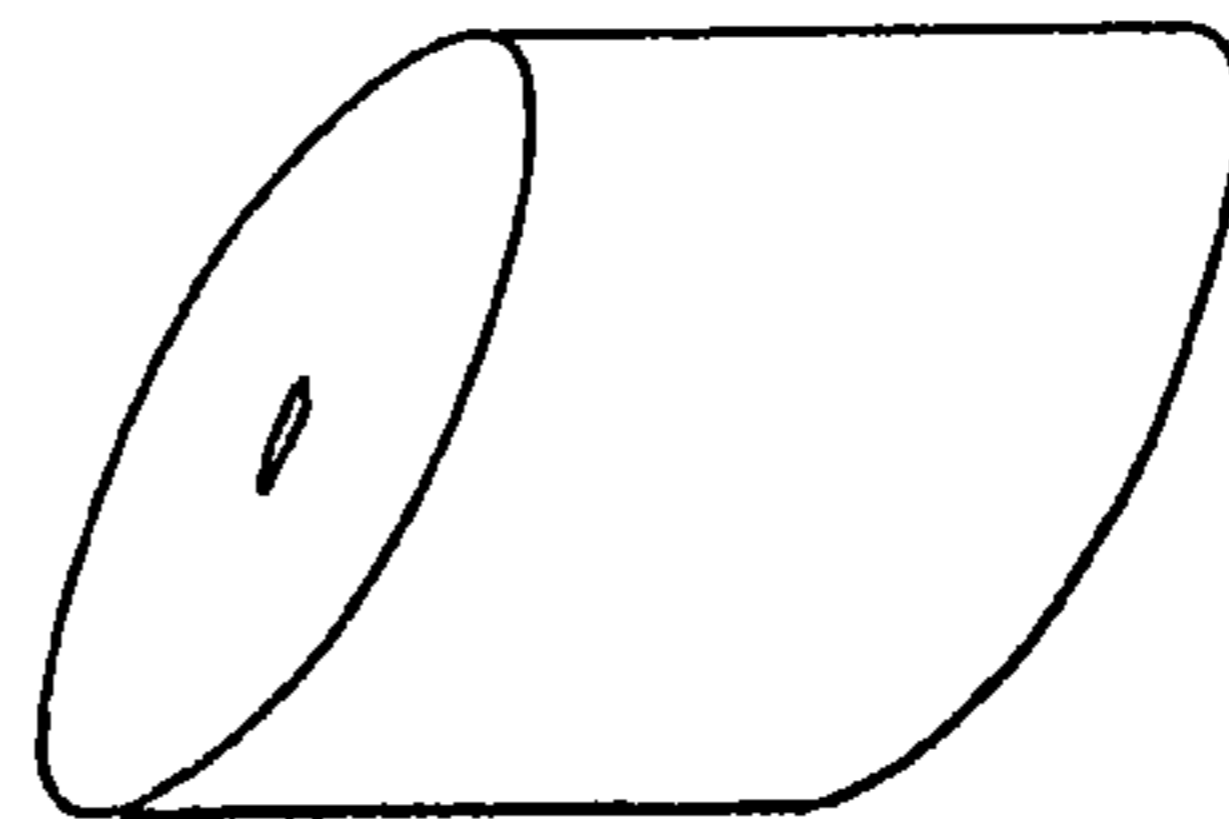

Fig. 84

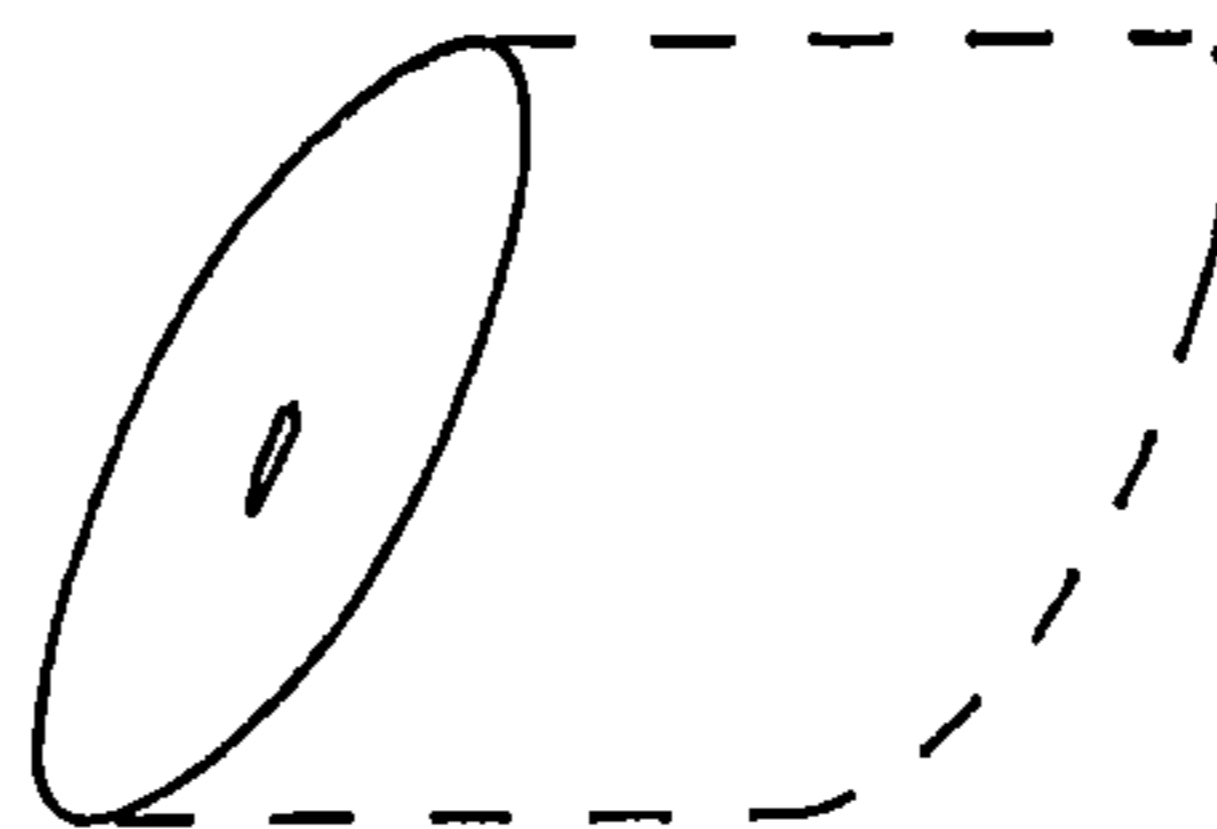

Fig. 85

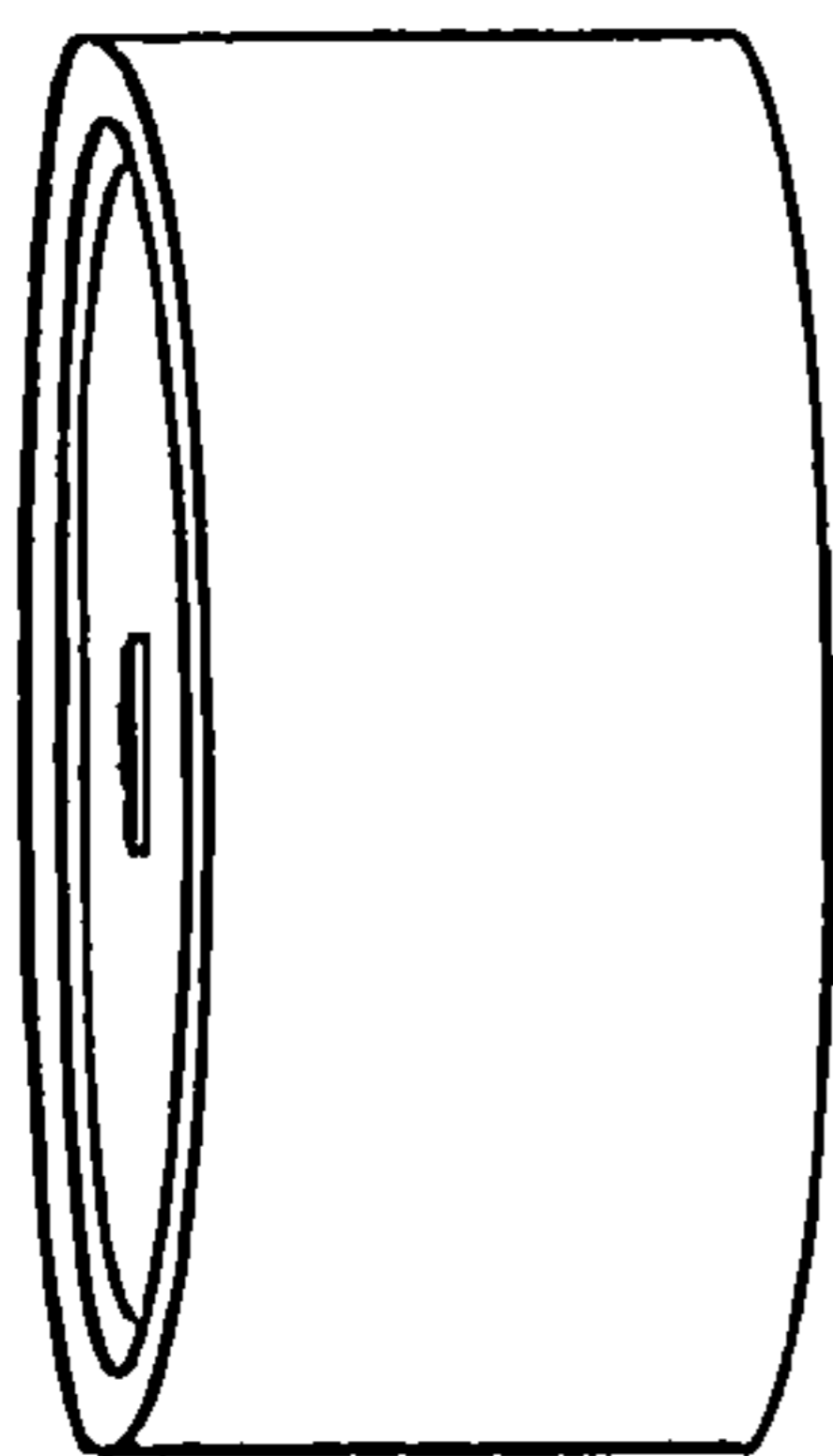

Fig. 86

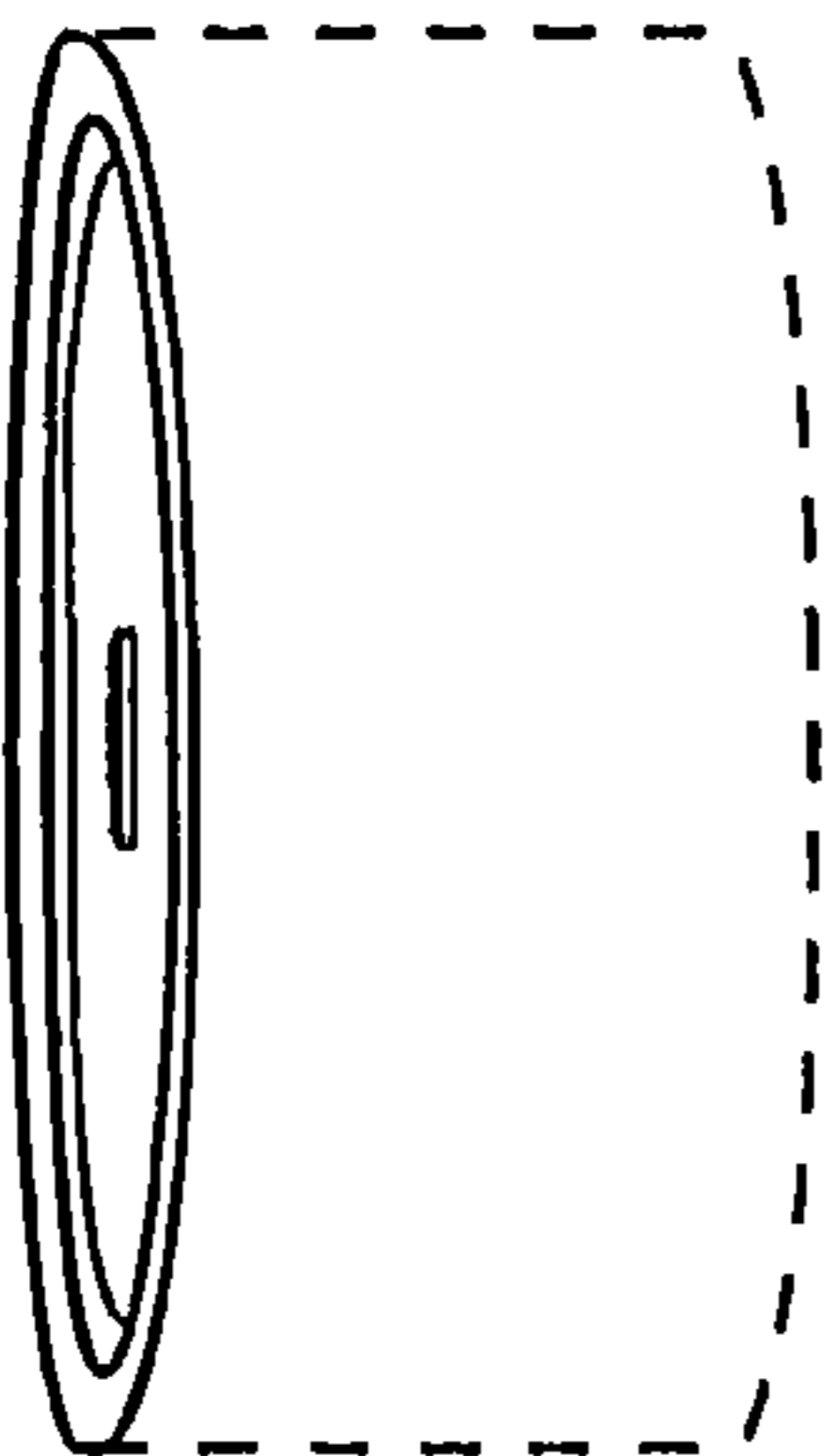

Fig. 87

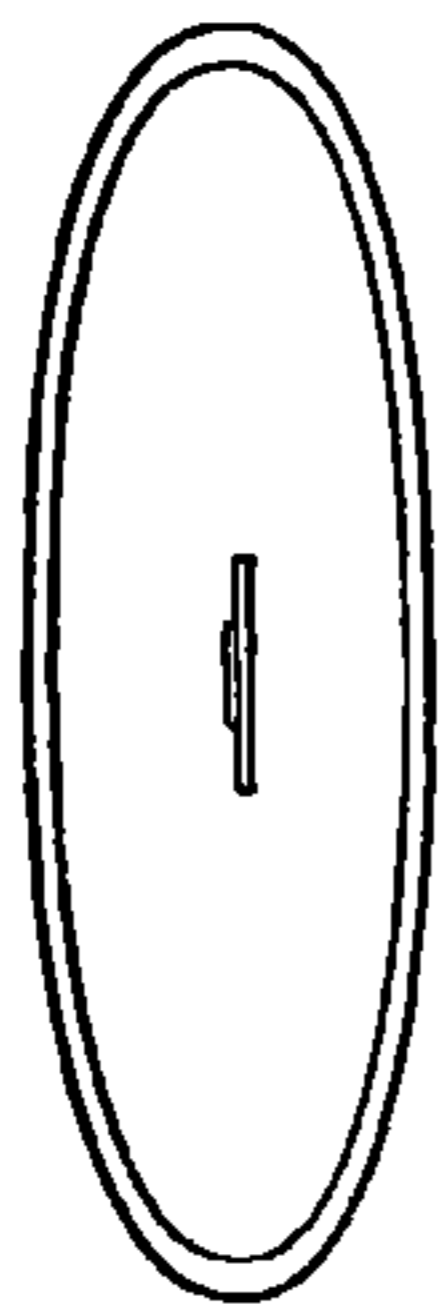

Fig. 88

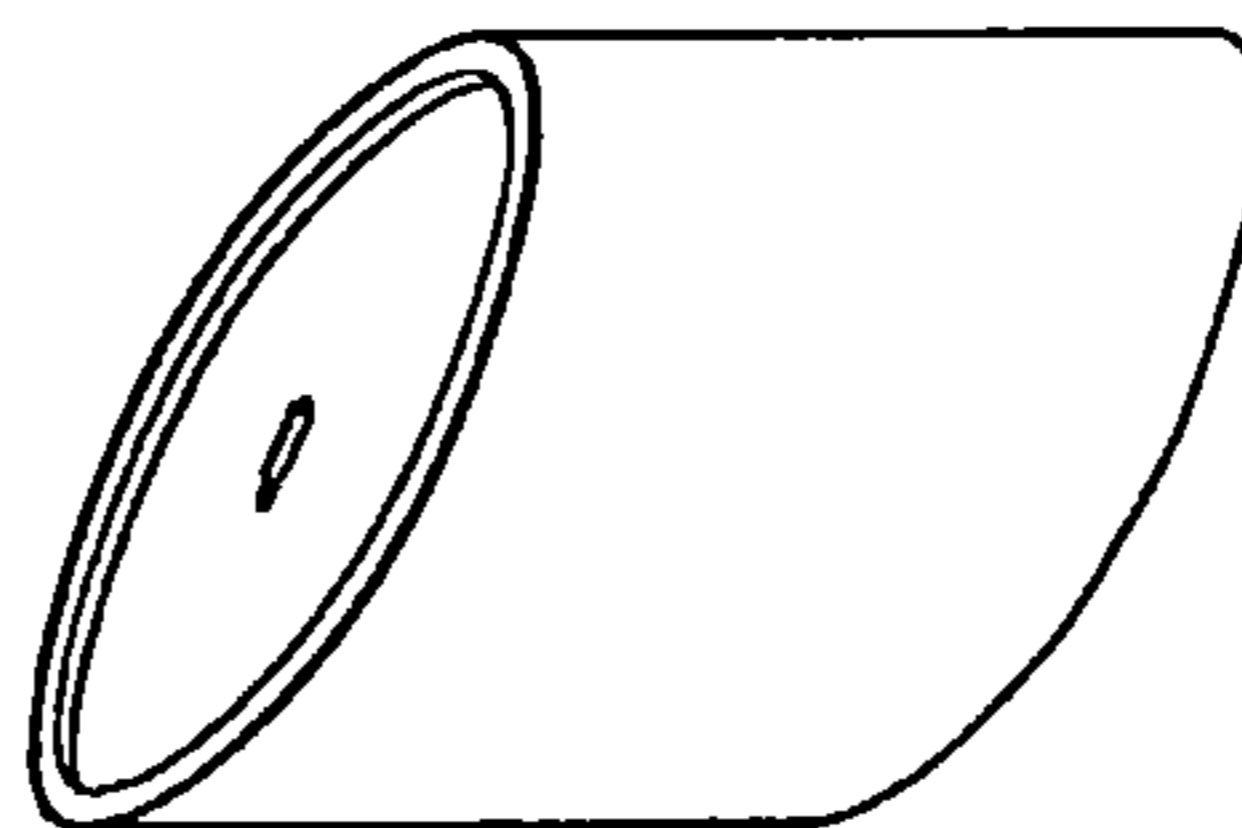

Fig. 89



Fig. 90

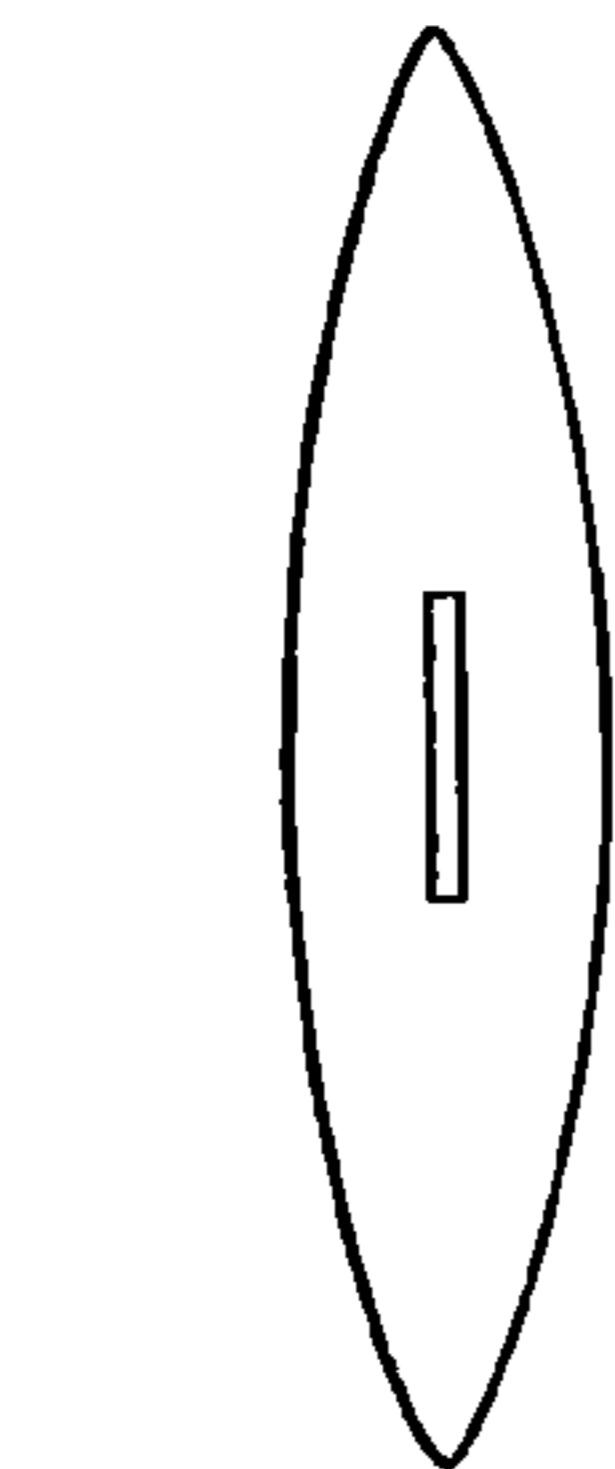

Fig. 93

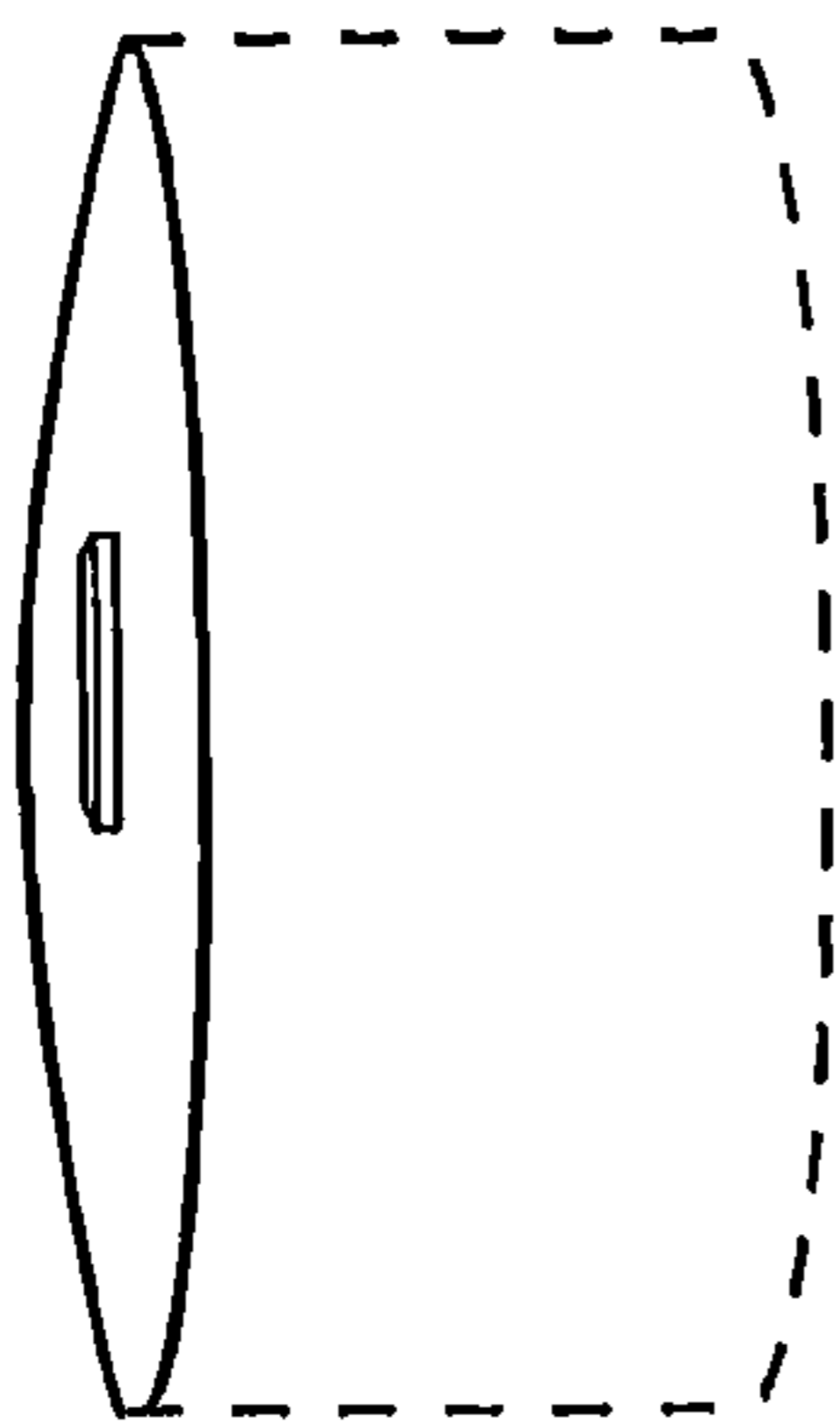

Fig. 92

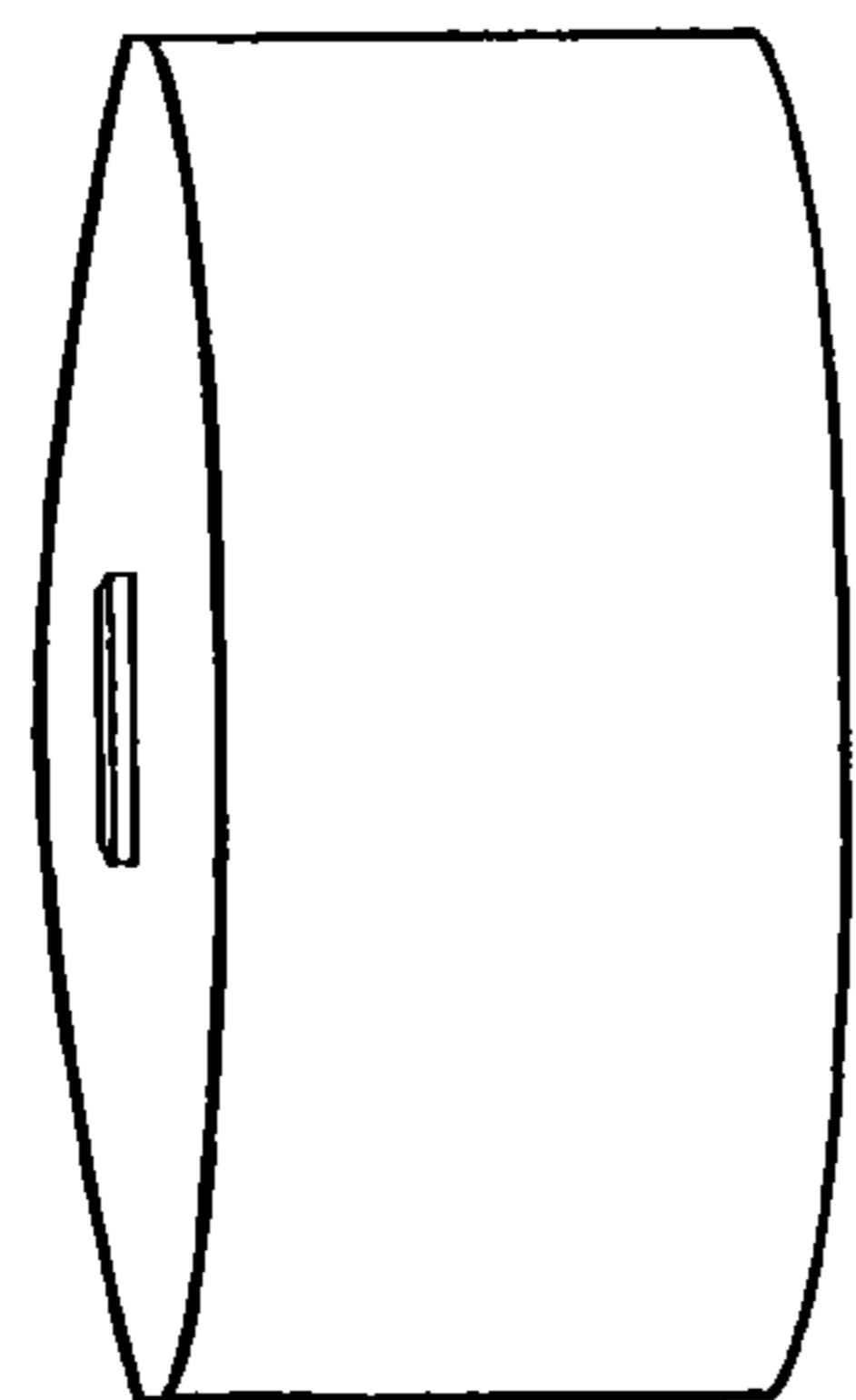

Fig. 91

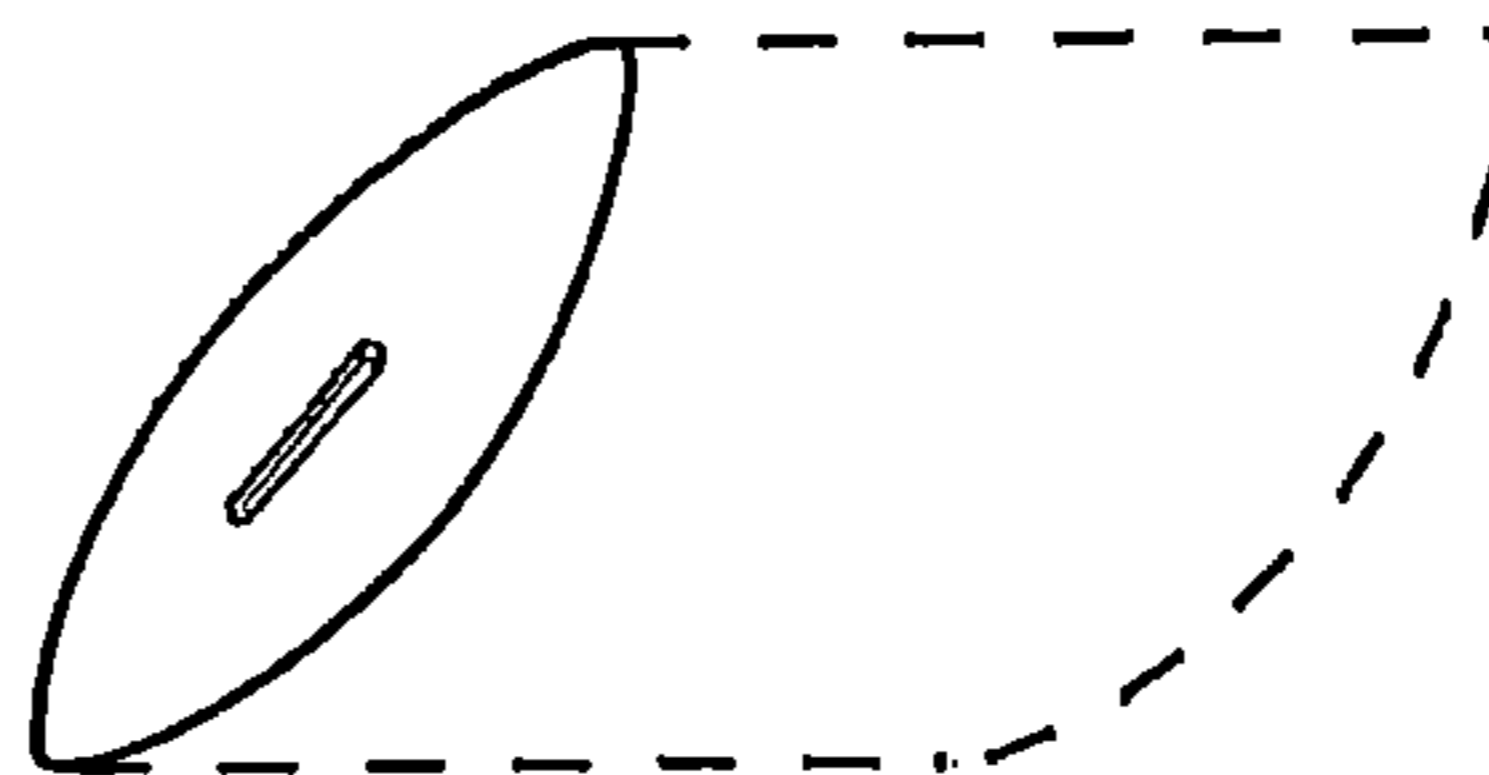

Fig. 95

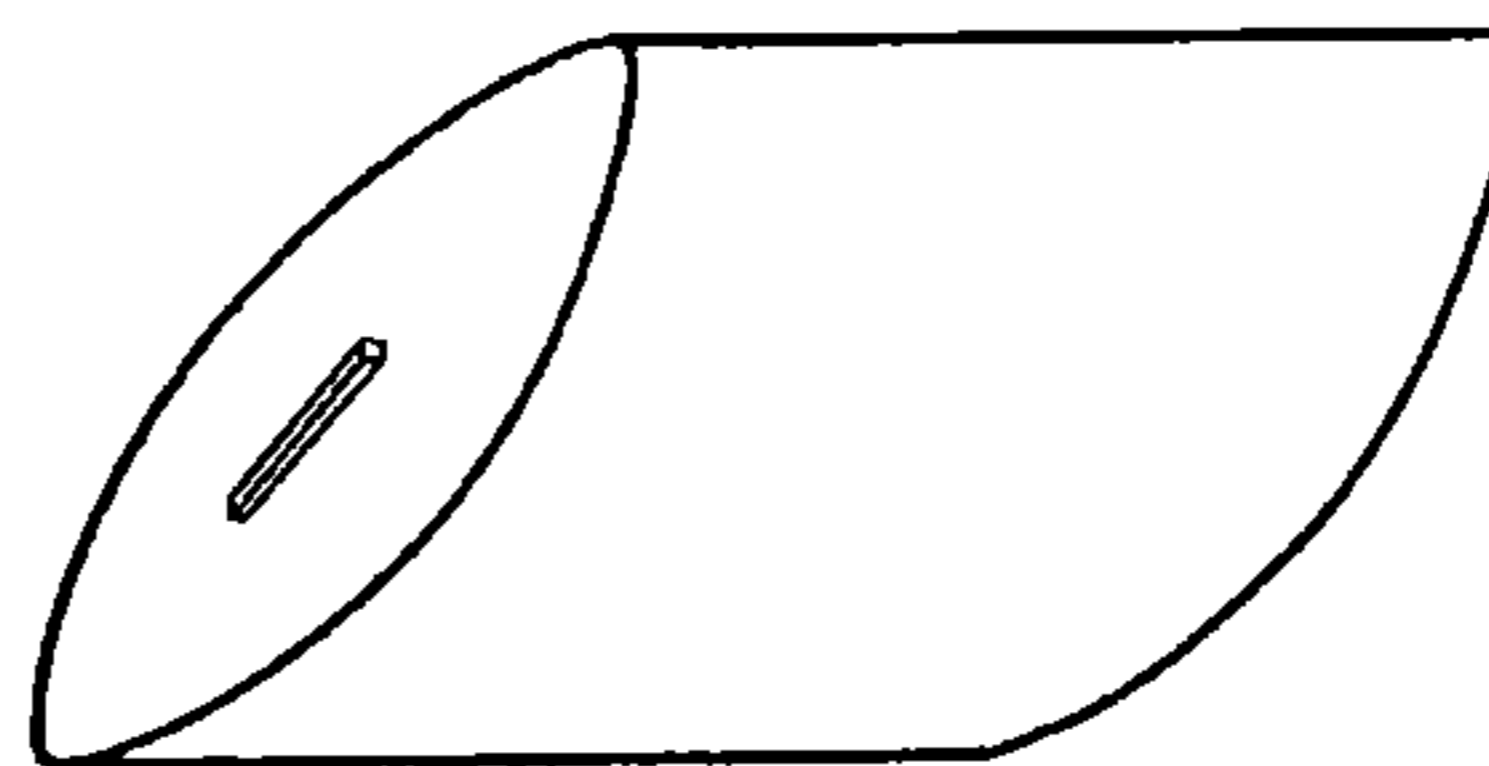

Fig. 94

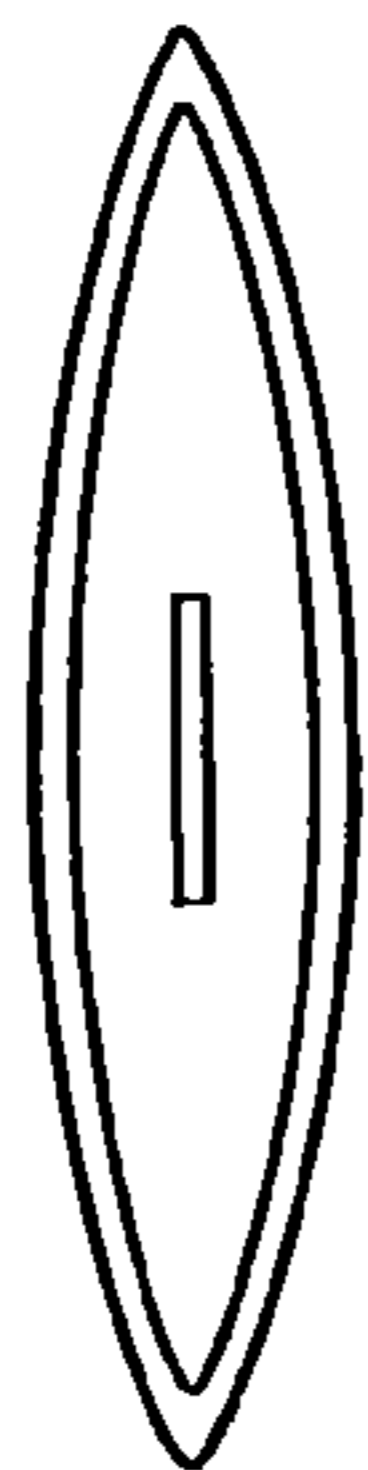

Fig. 98

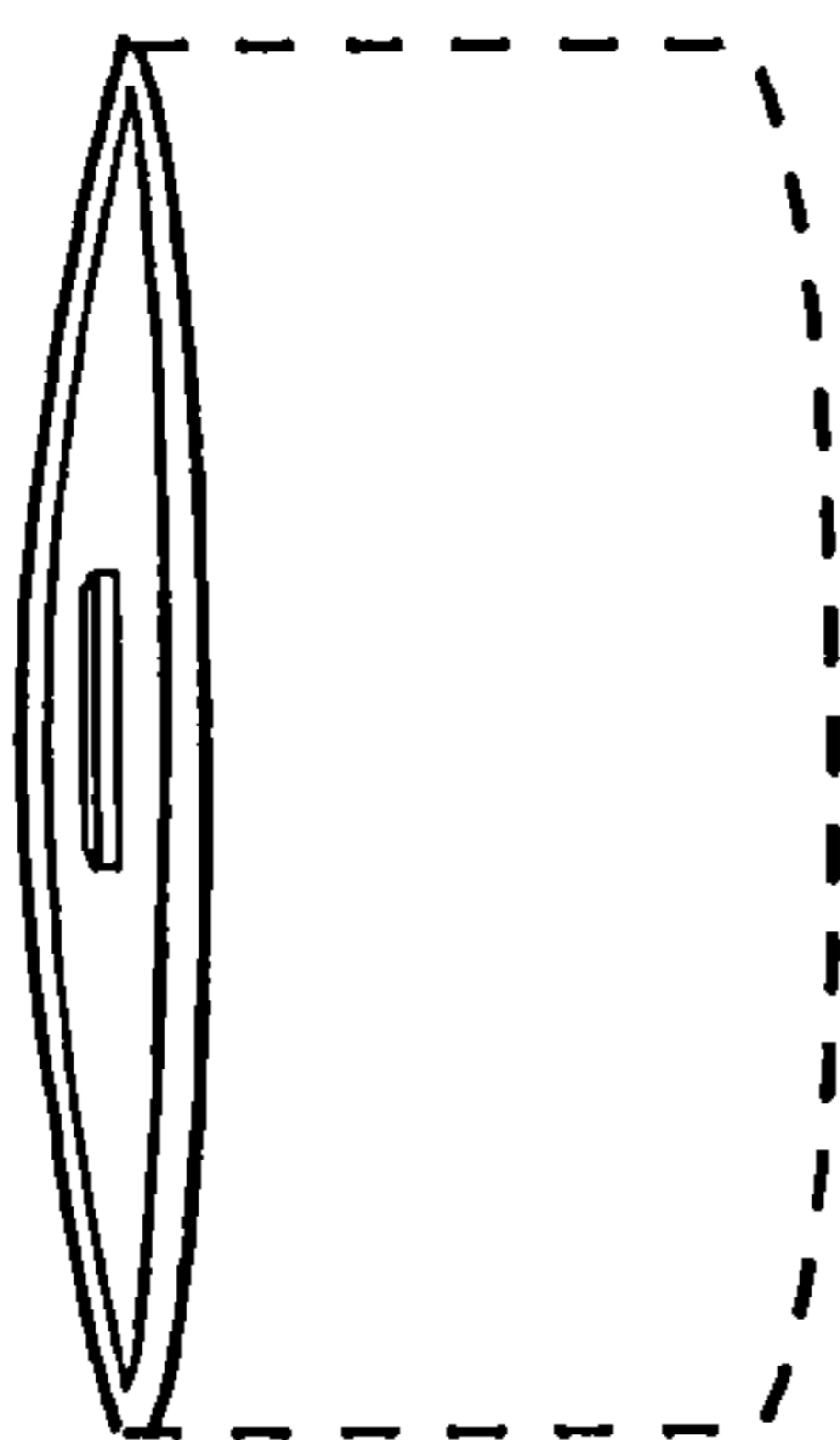

Fig. 97

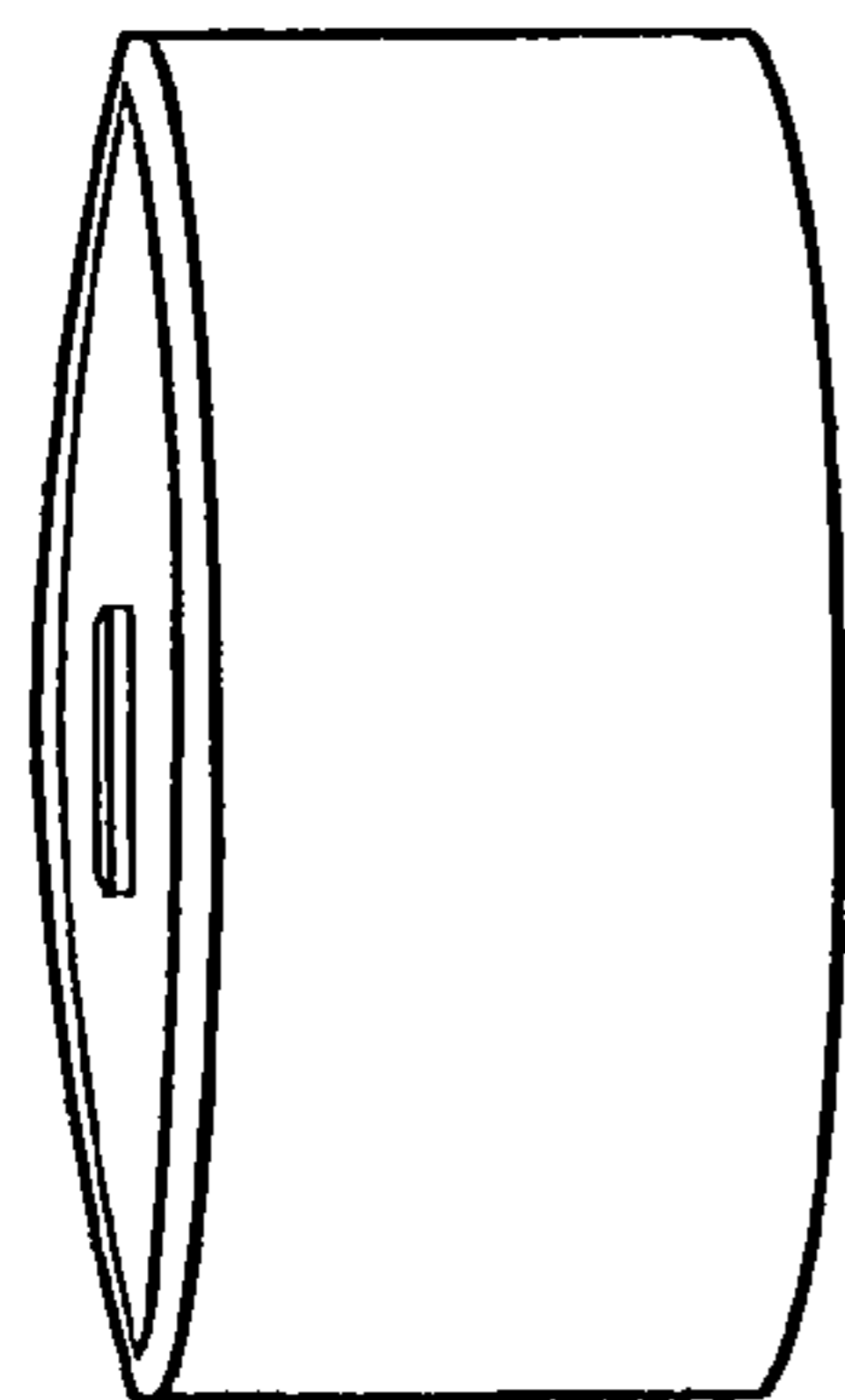

Fig. 96

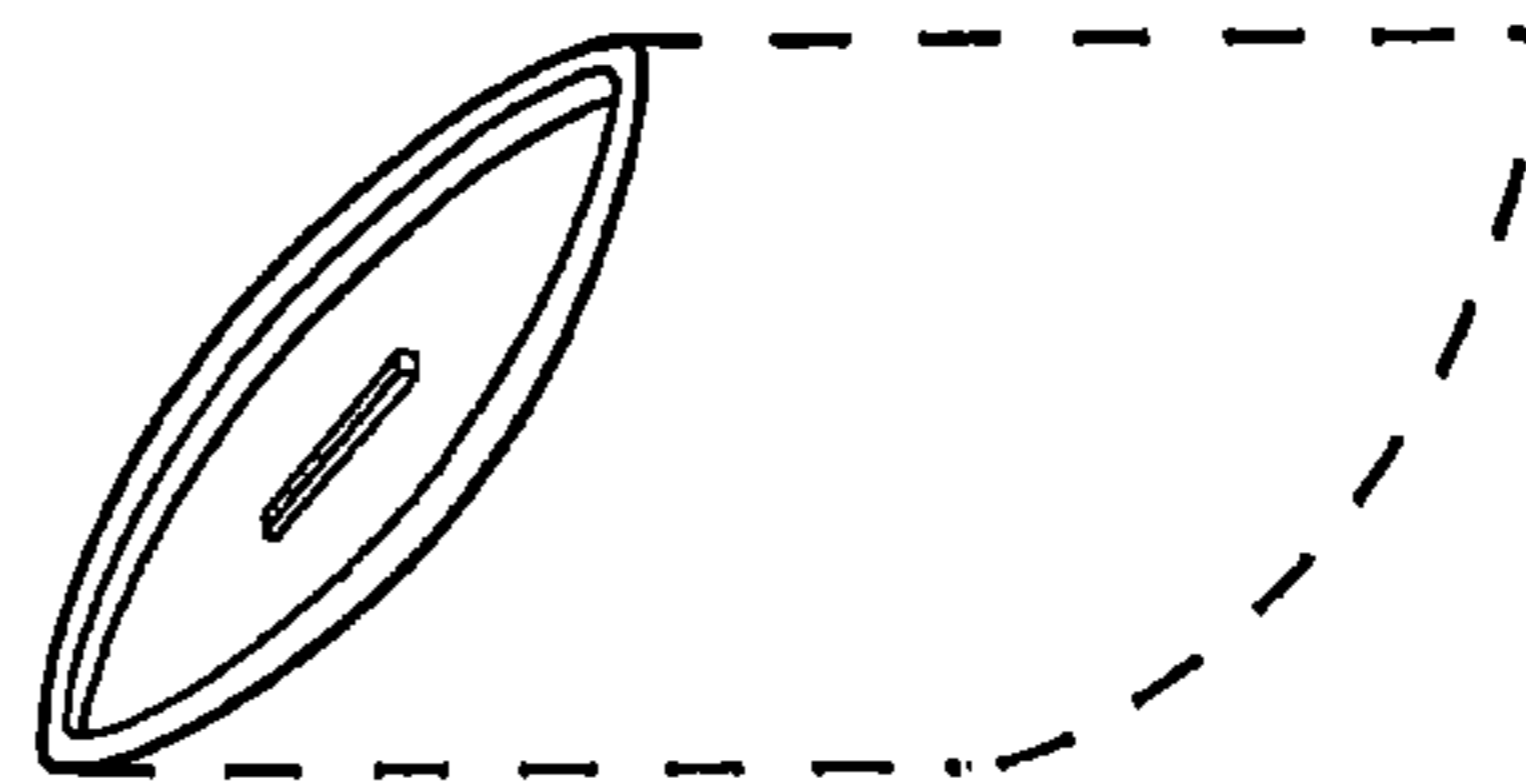

Fig. 100

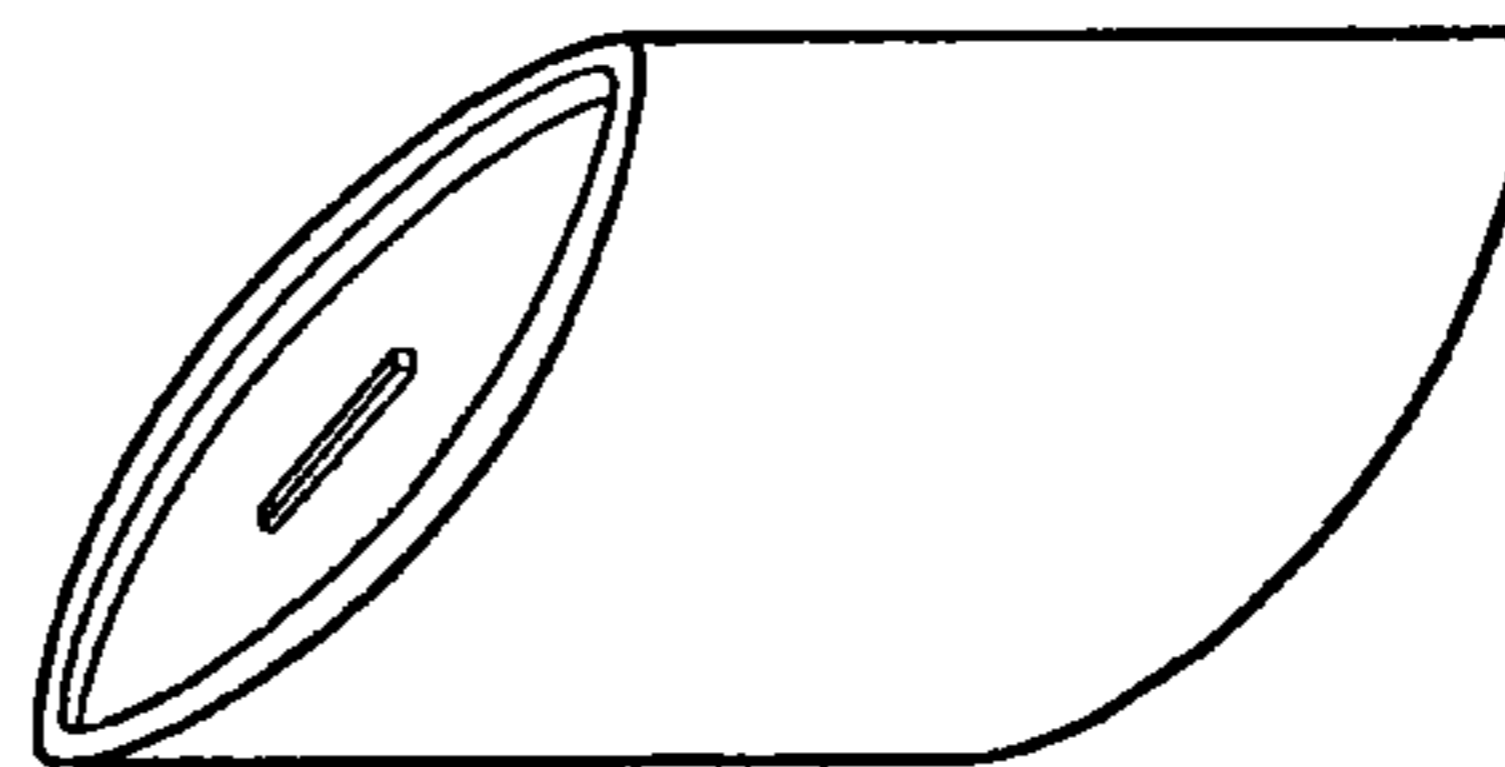

Fig. 99

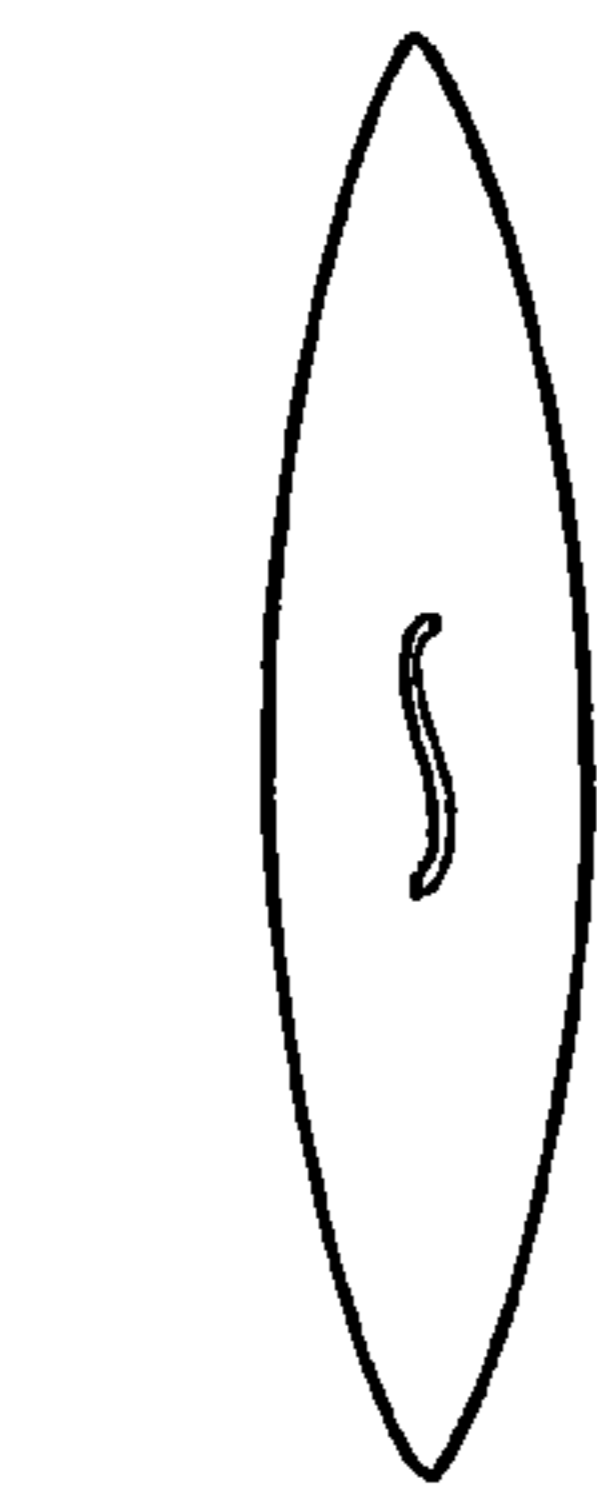

Fig. 103

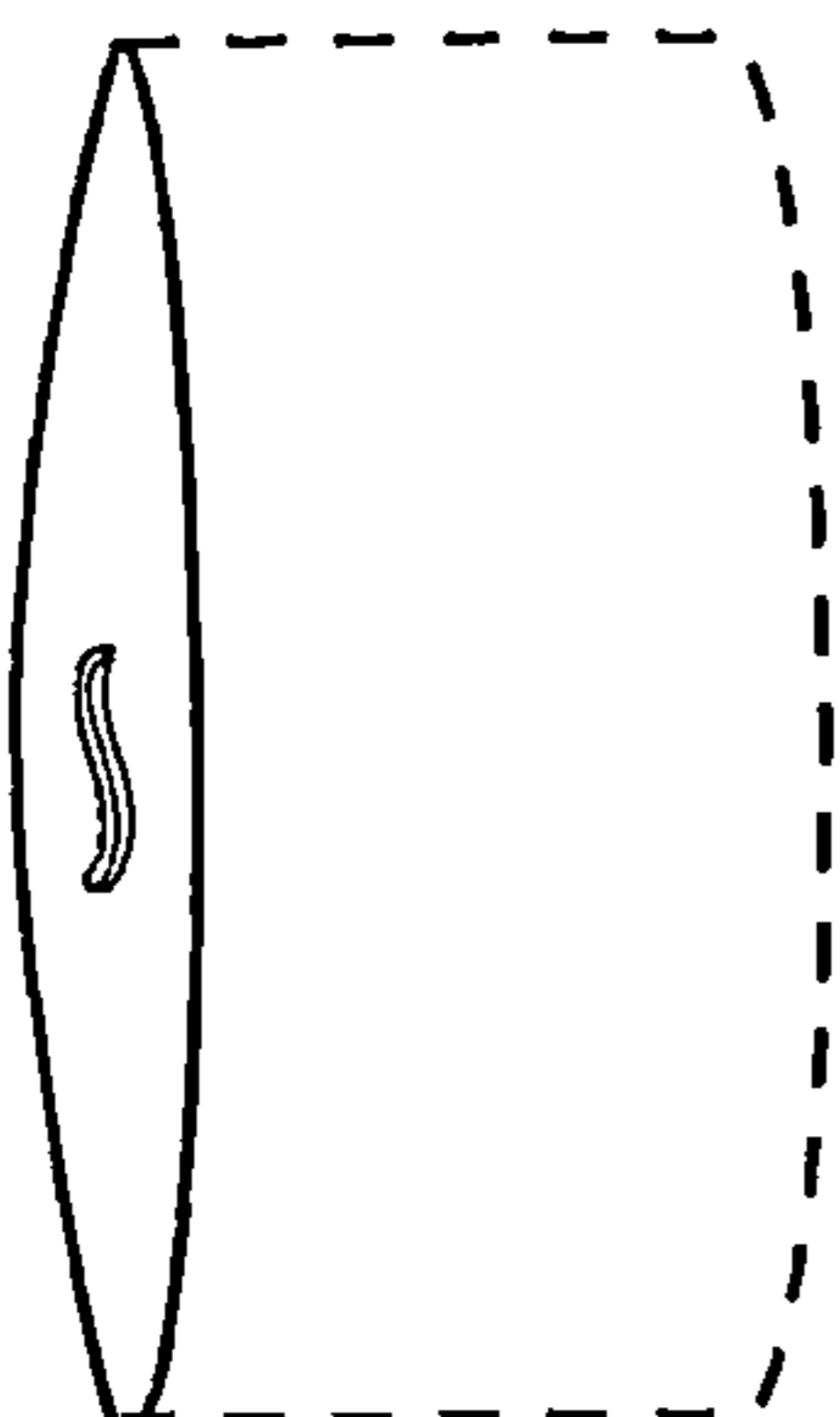

Fig. 102

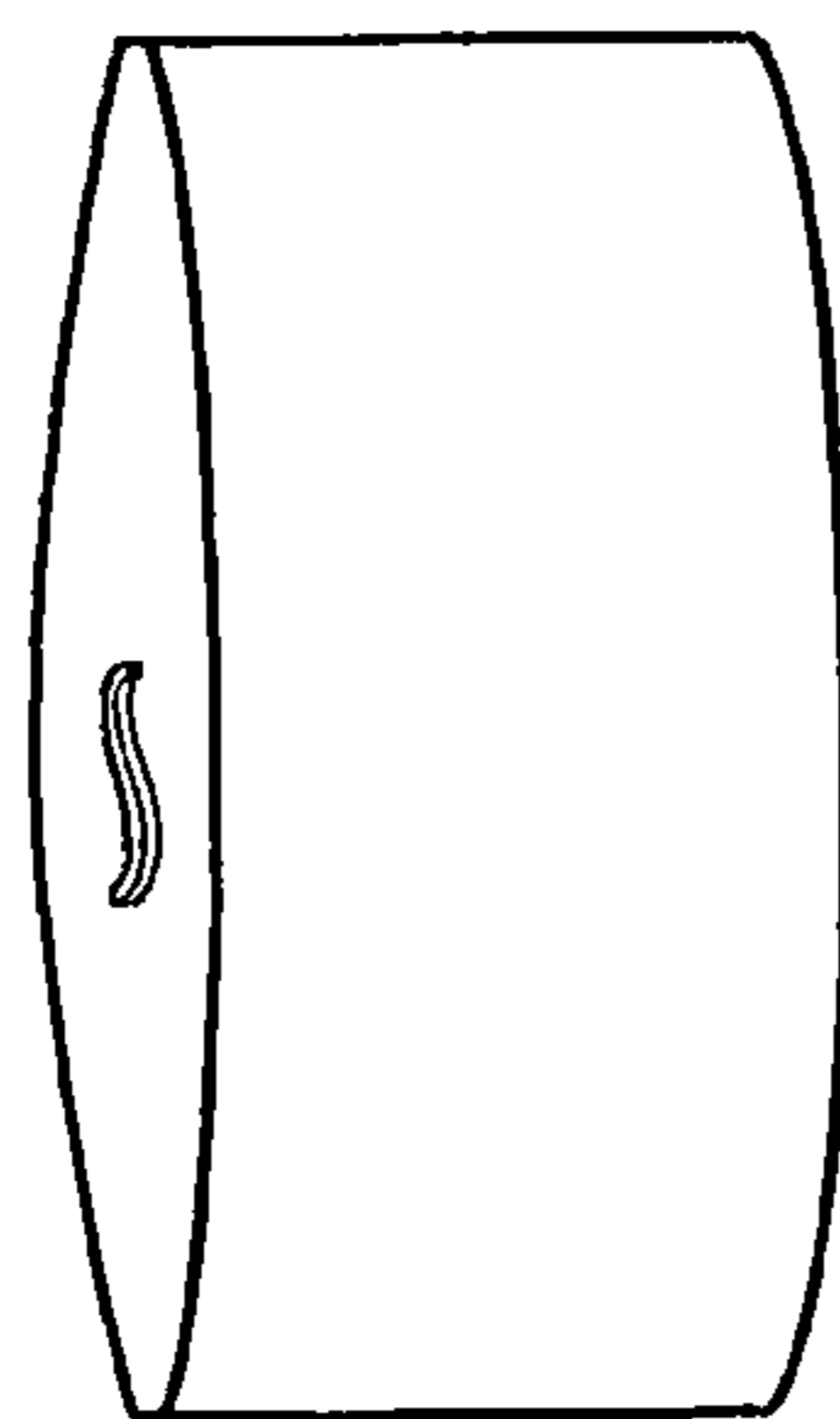

Fig. 101

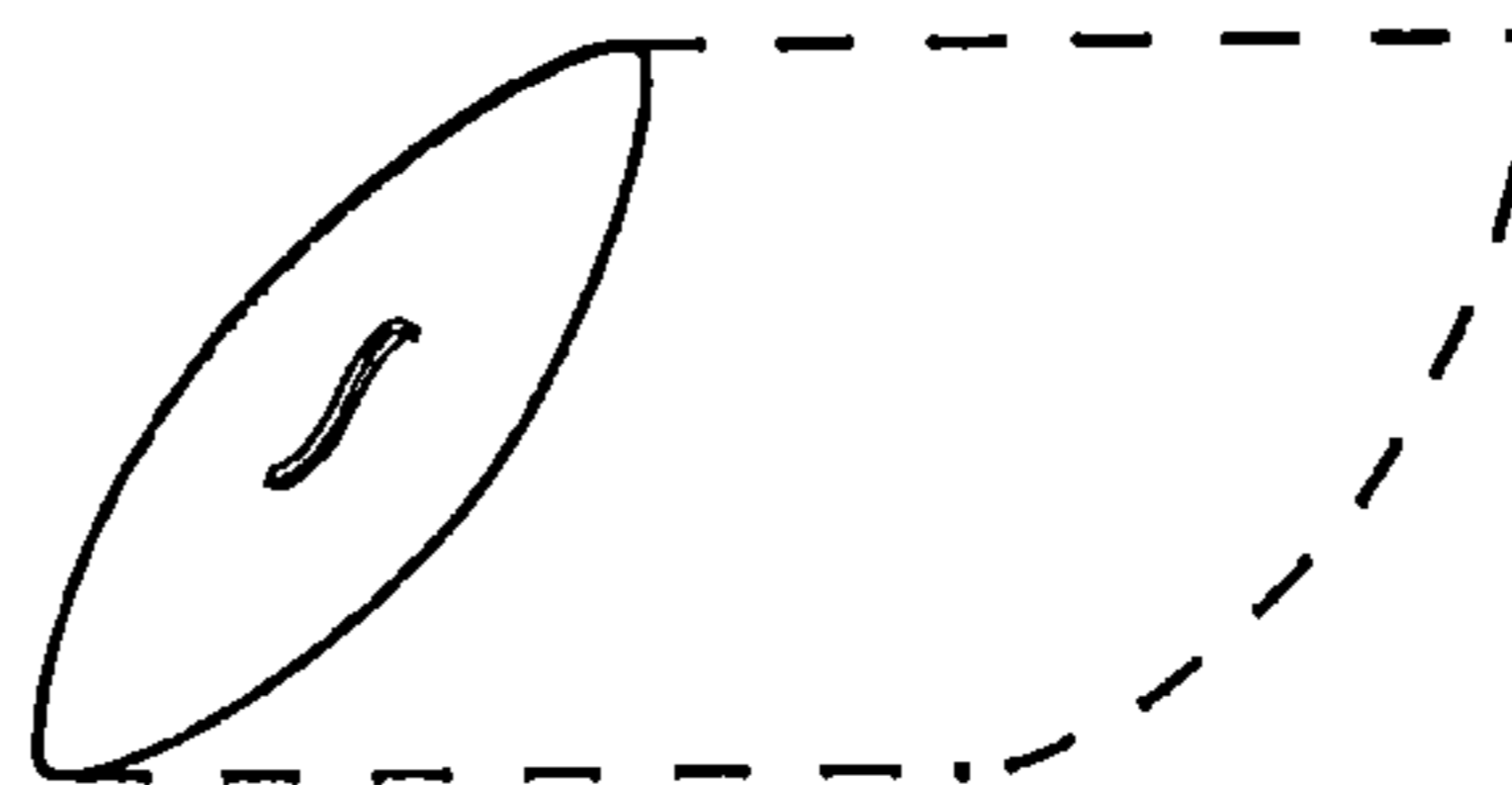

Fig. 105

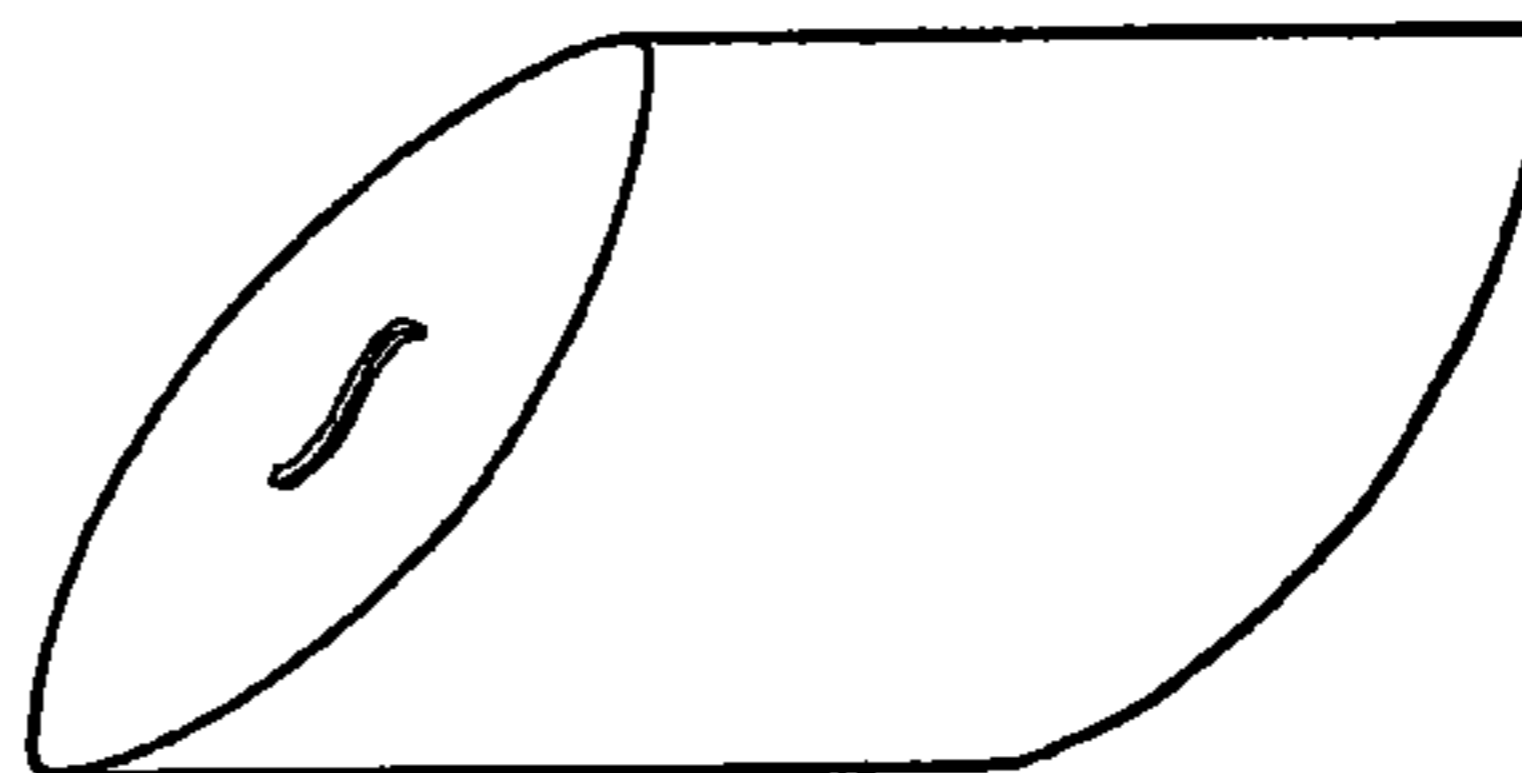

Fig. 104

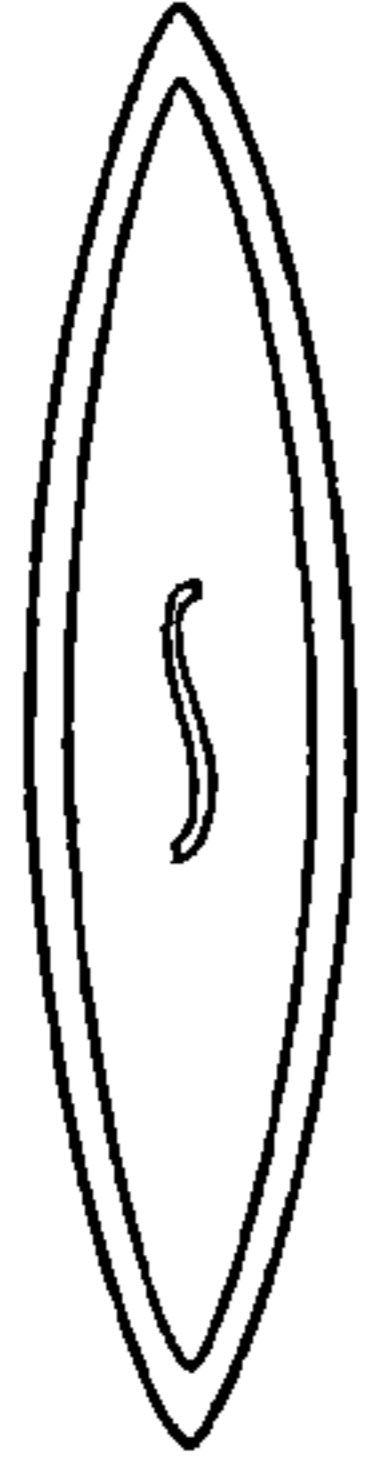

Fig. 108

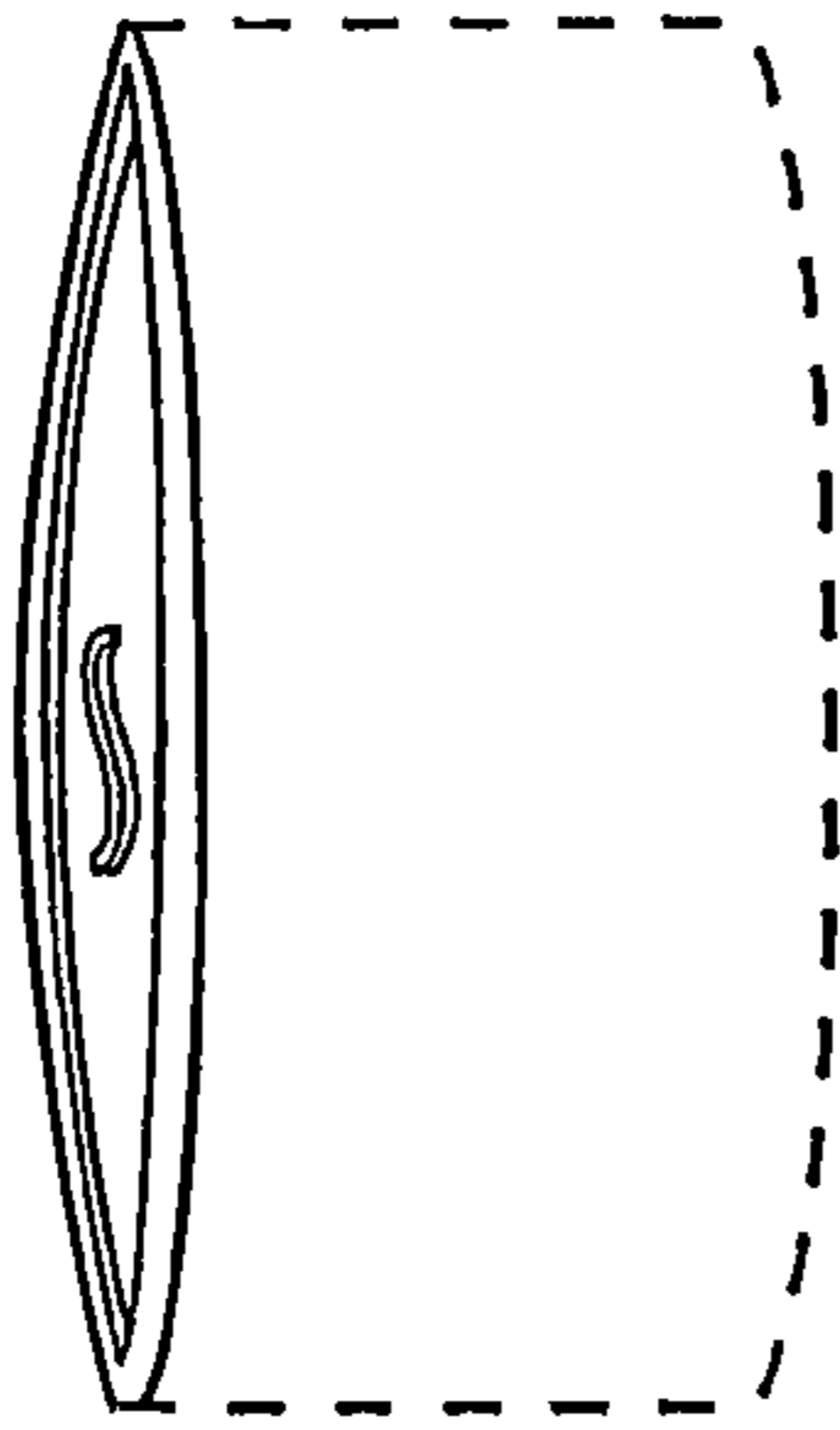

Fig. 107

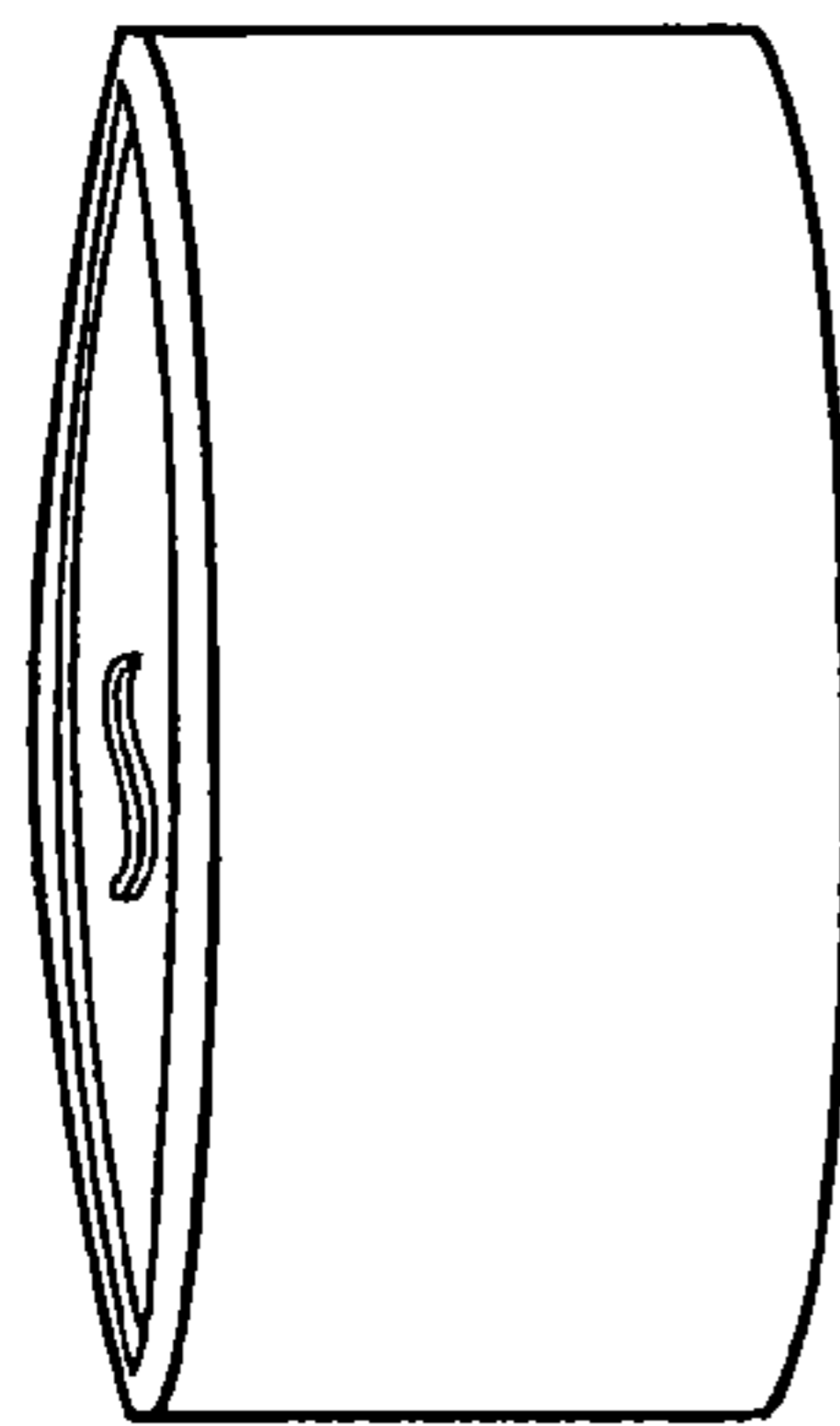

Fig. 106



Fig. 110

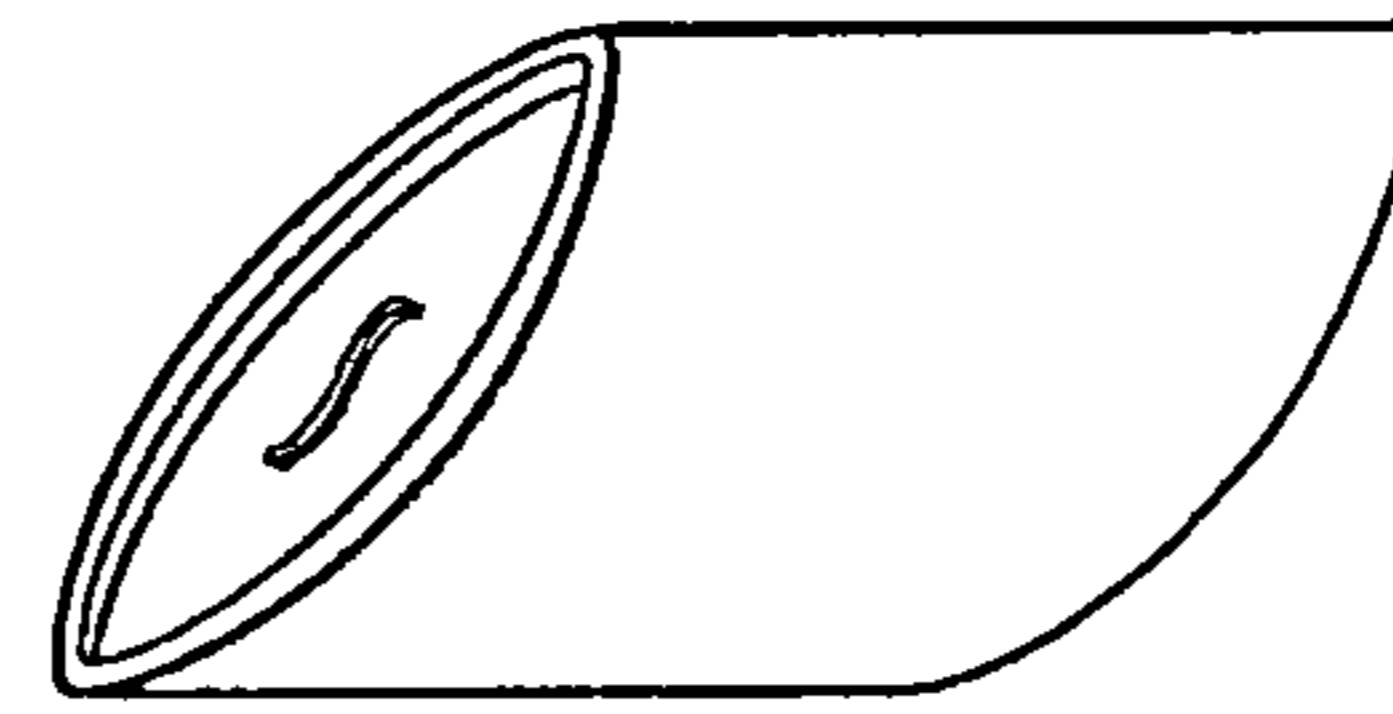

Fig. 109

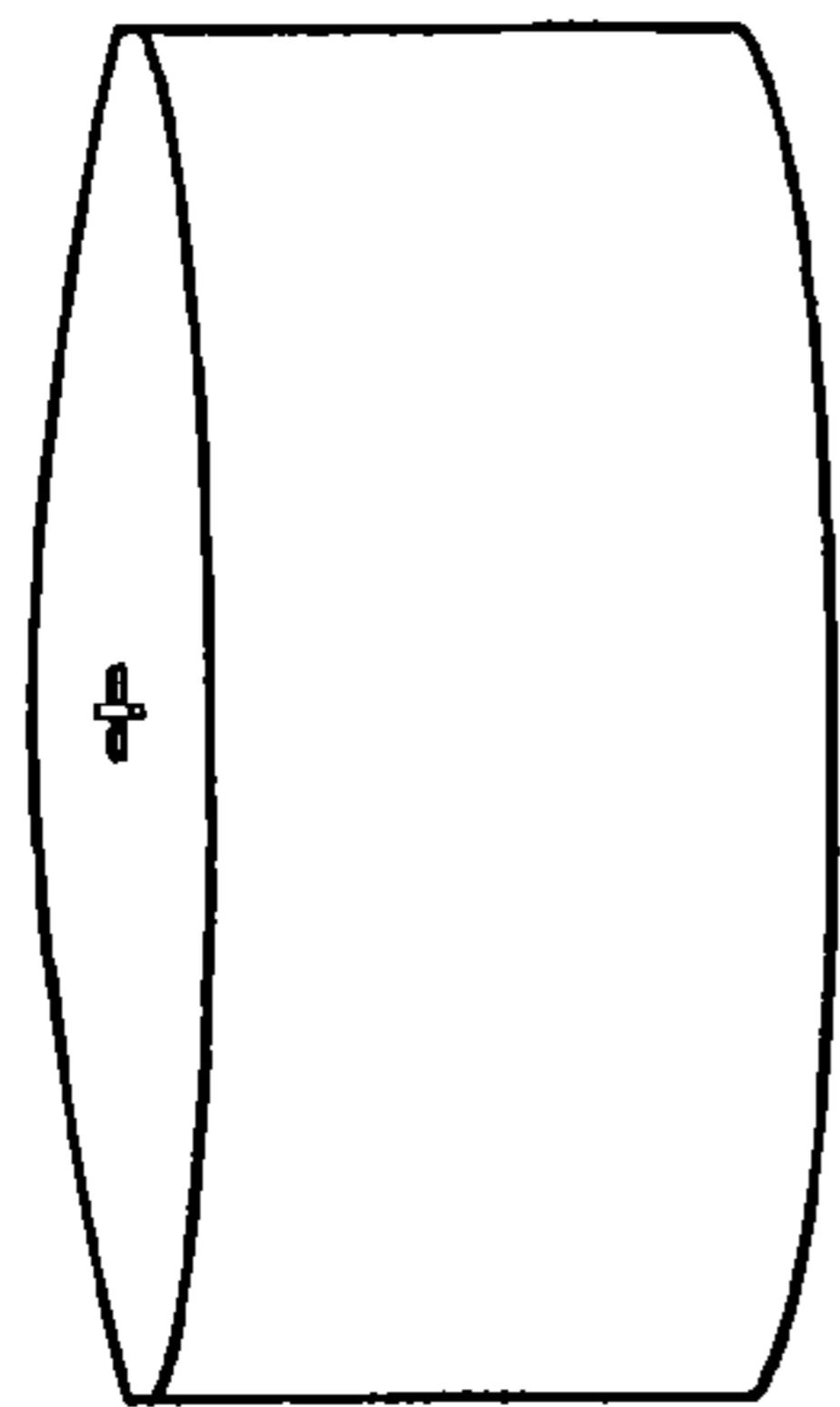

Fig. 111

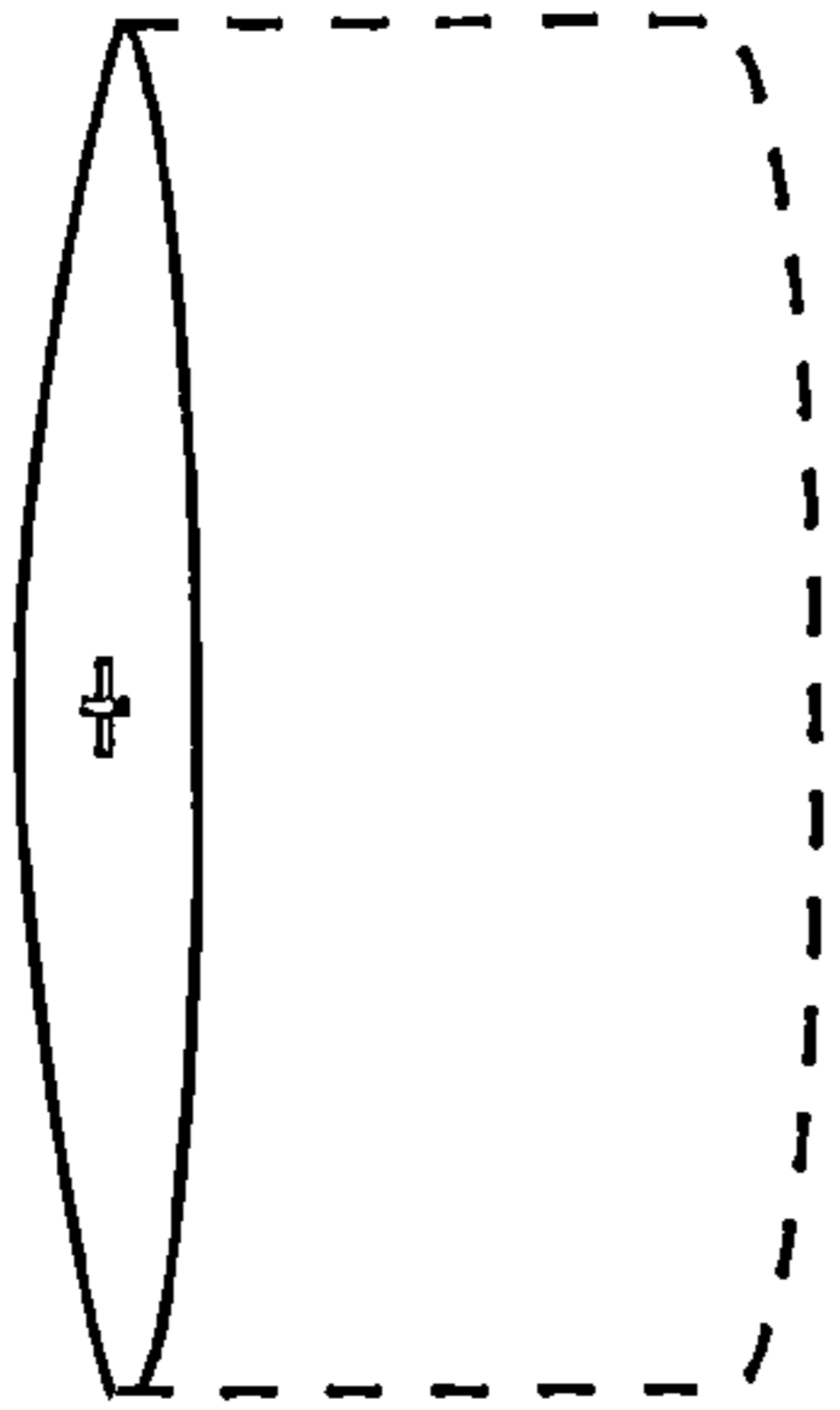

Fig. 112

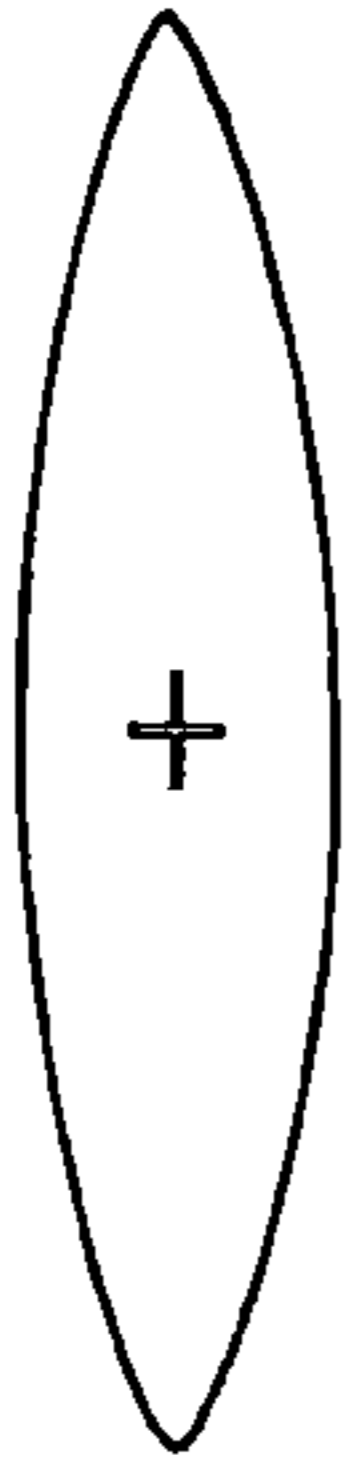

Fig. 113

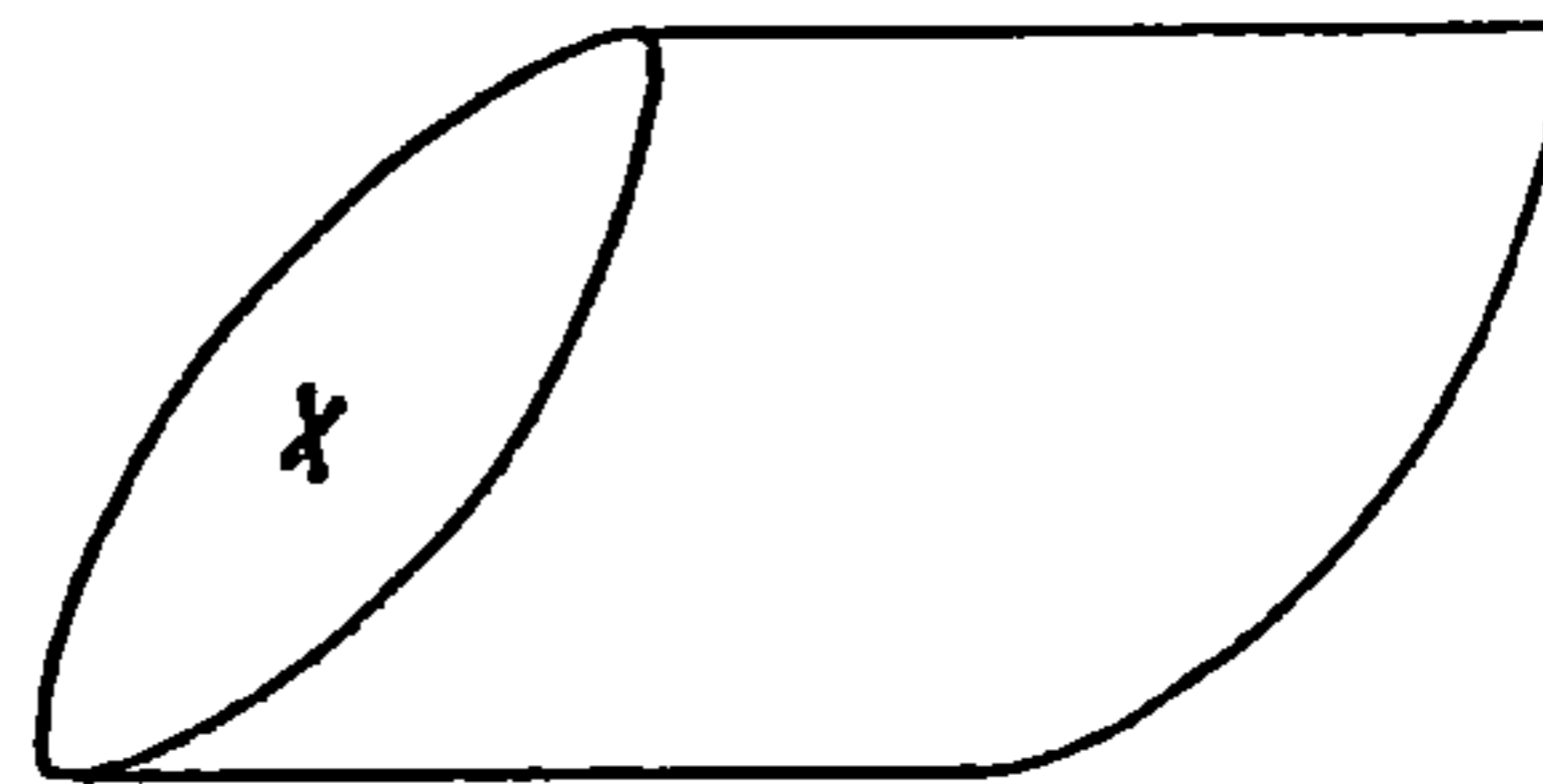

Fig. 114

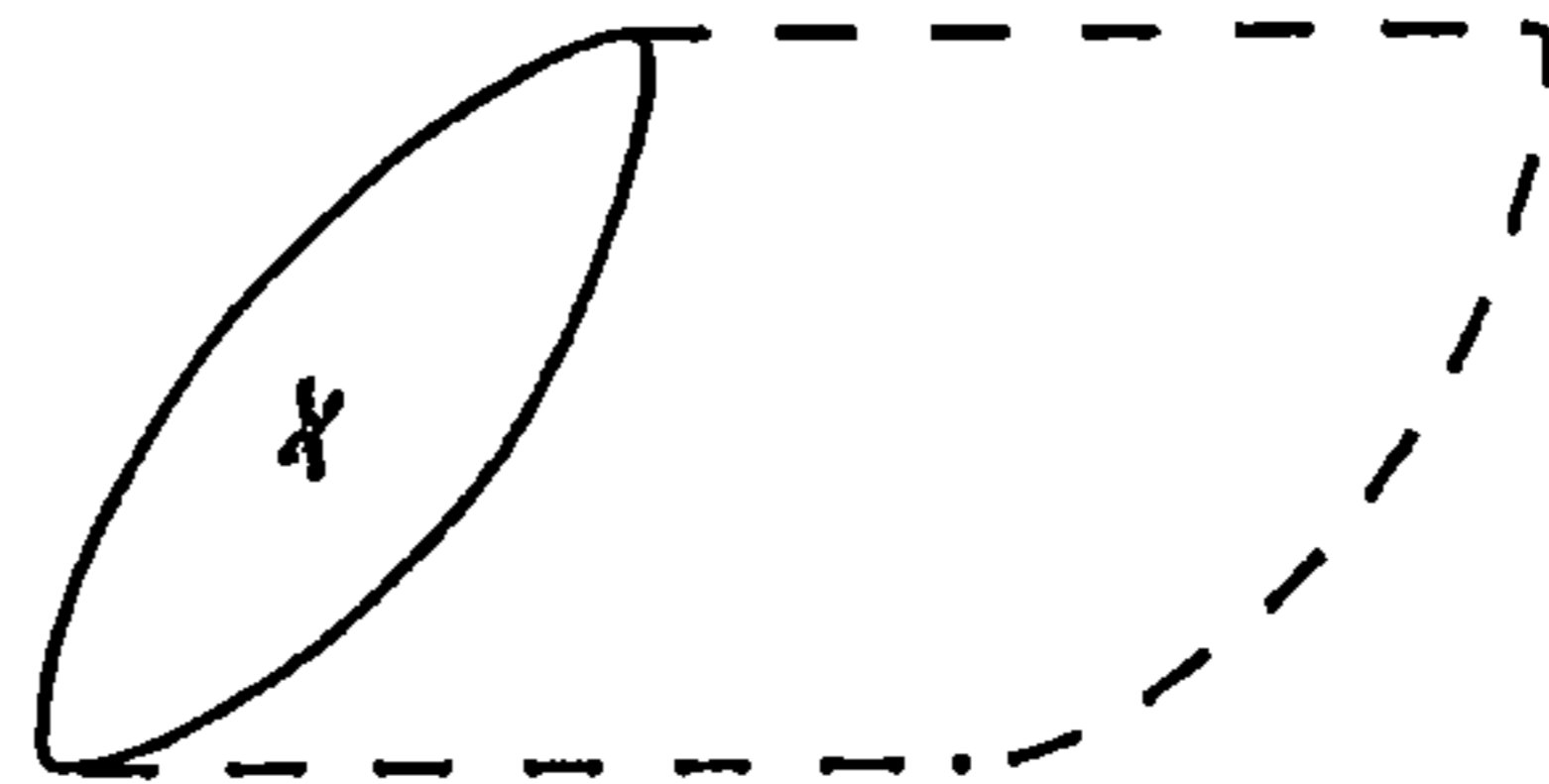

Fig. 115

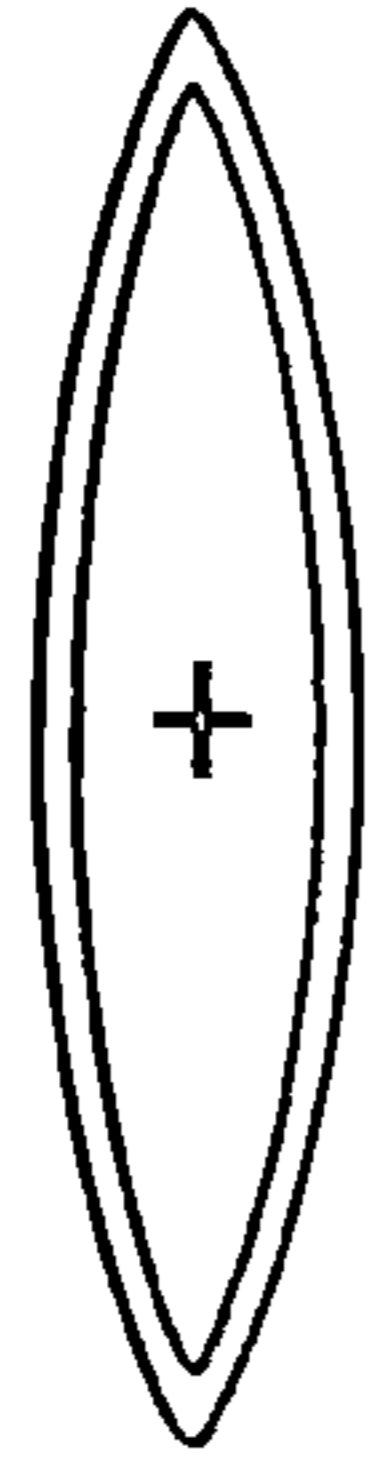

Fig. 118

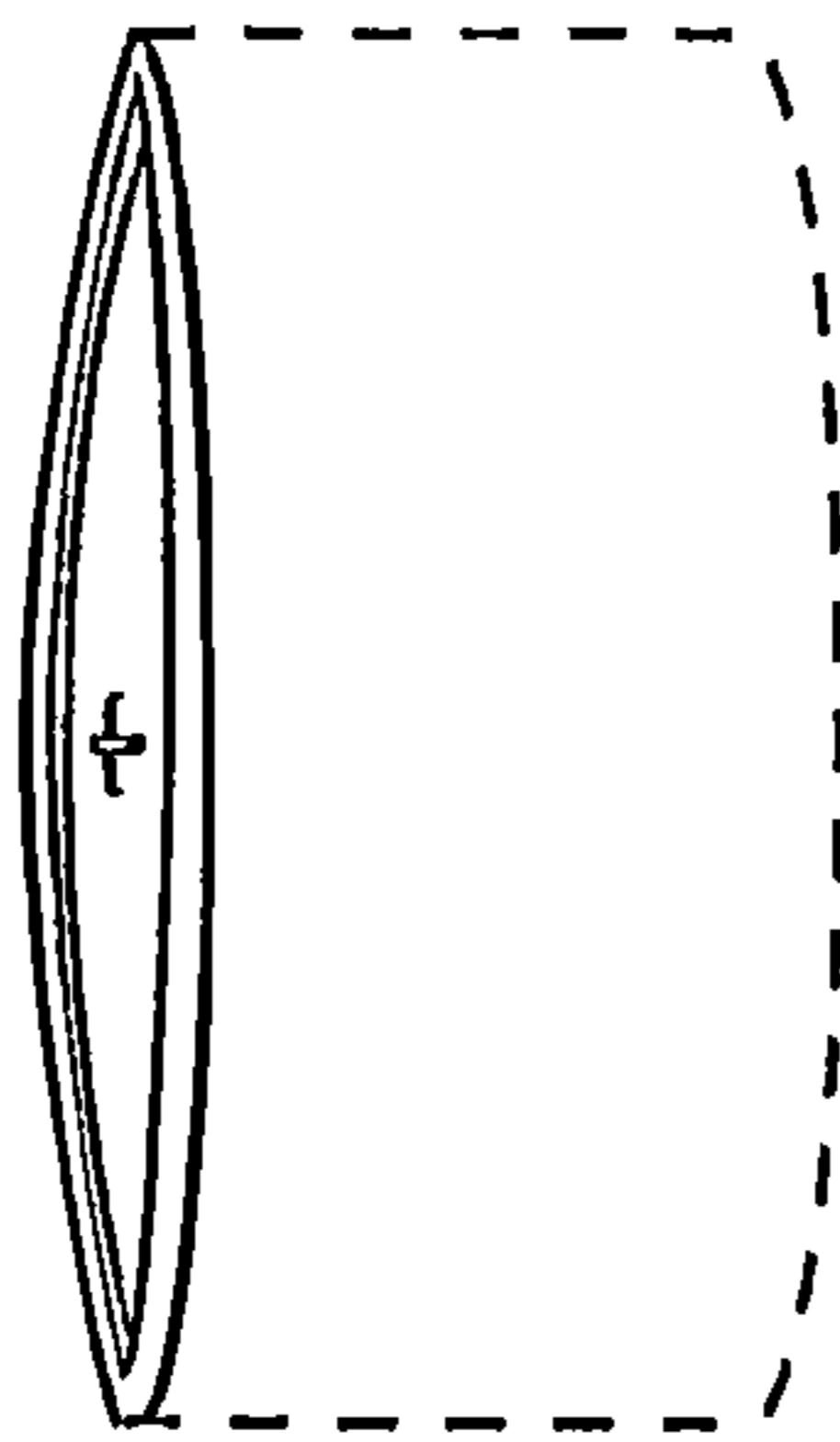

Fig. 117

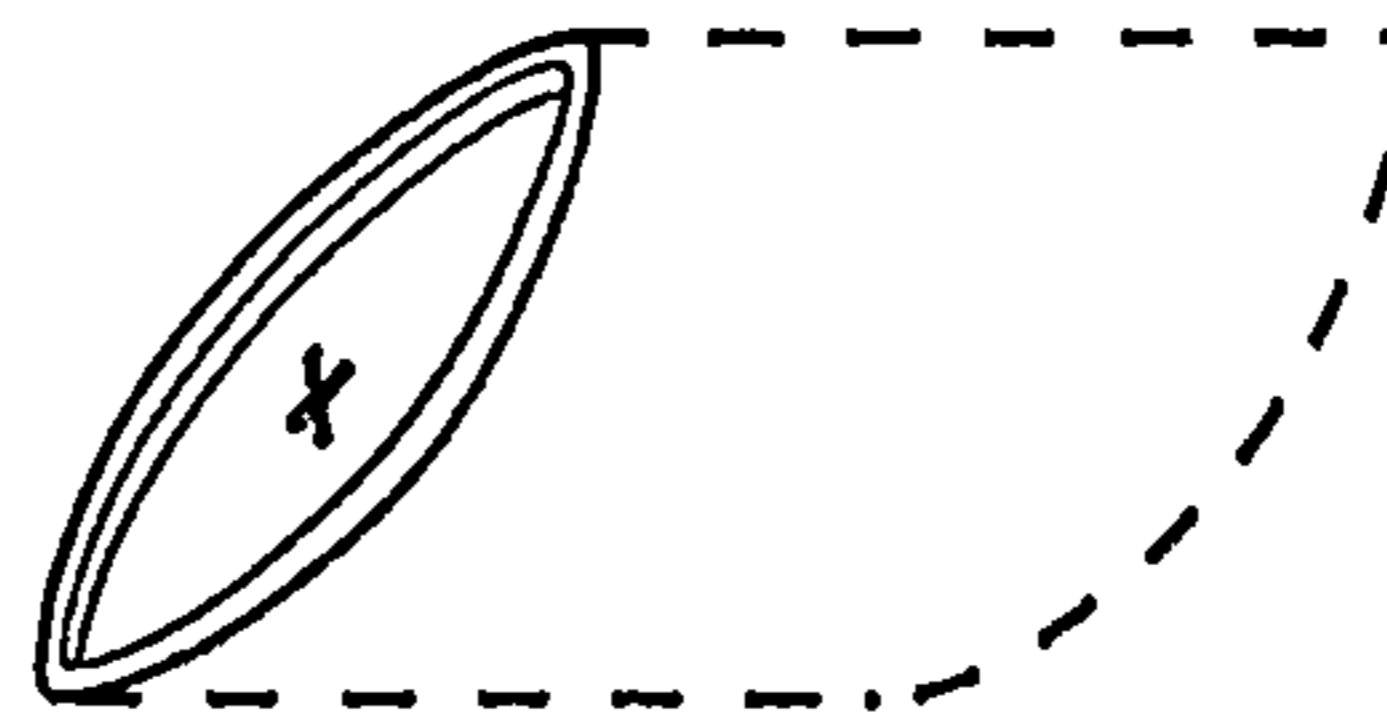

Fig. 120

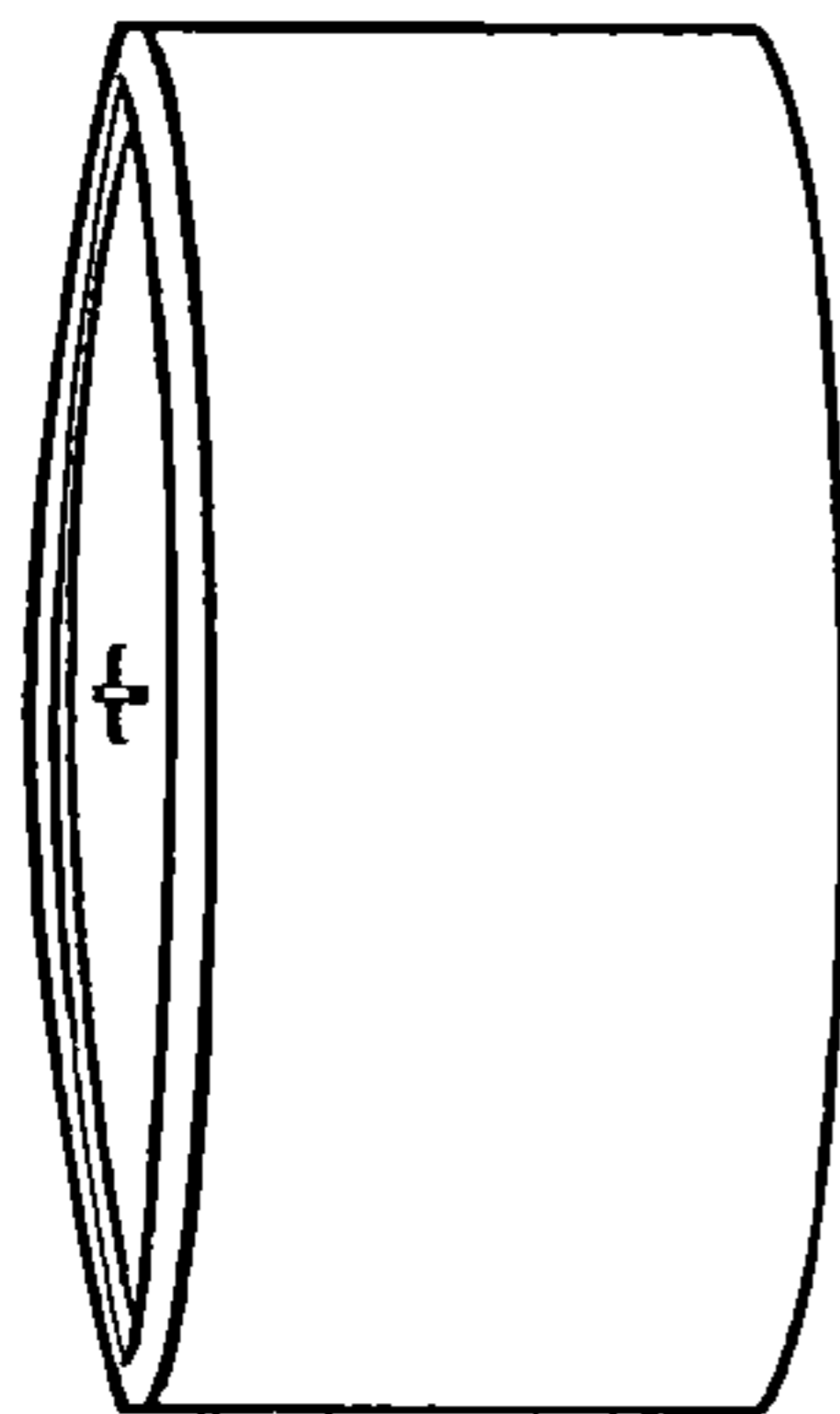

Fig. 116

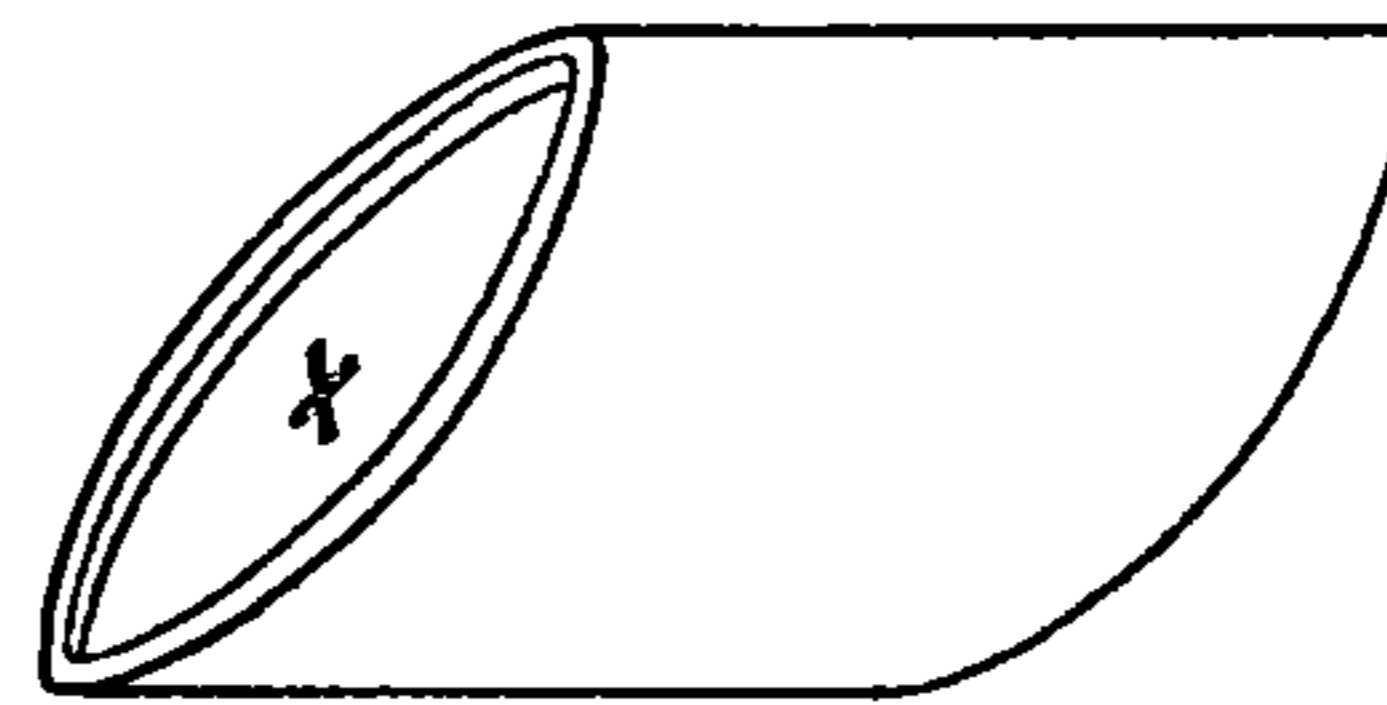

Fig. 119

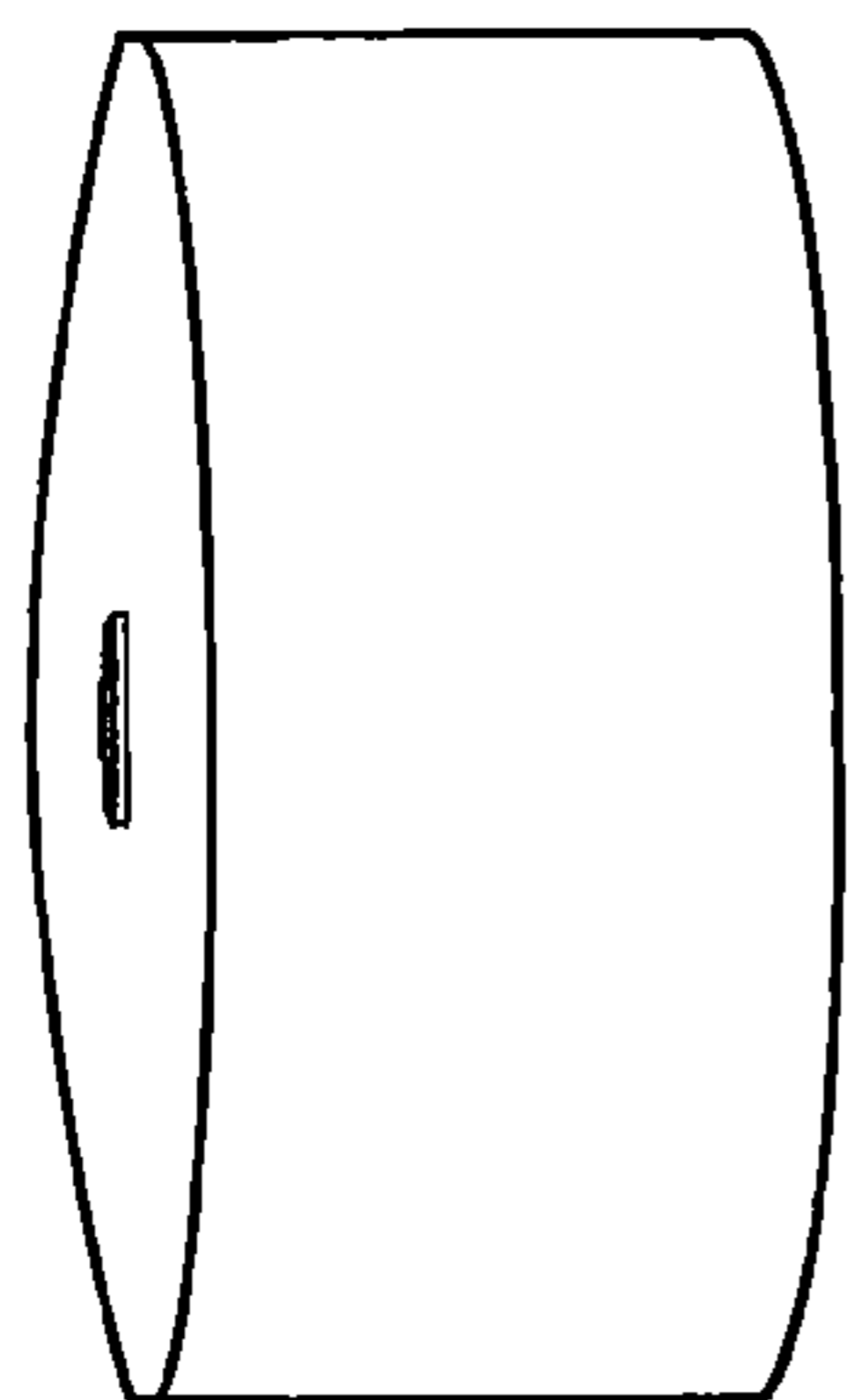

Fig. 121

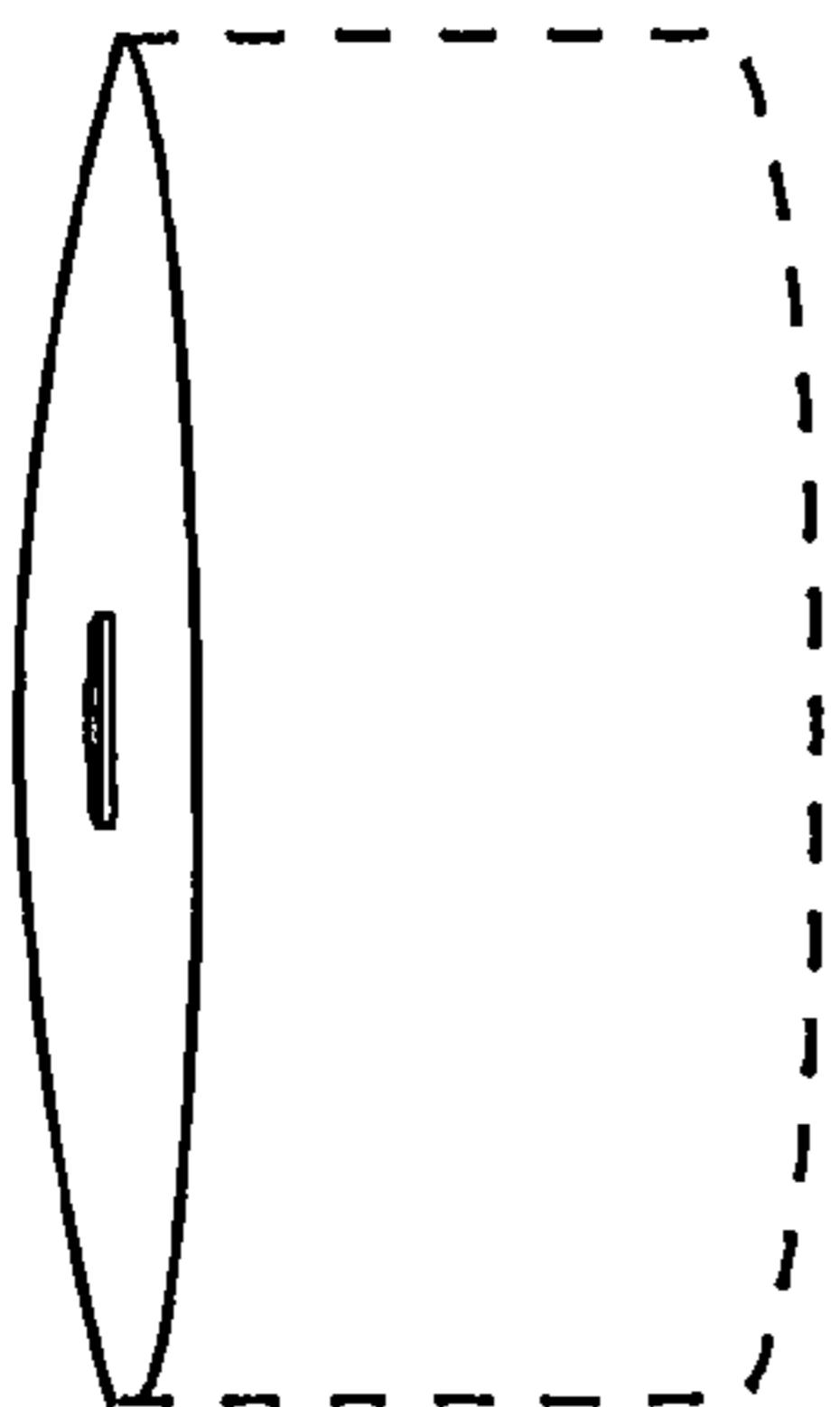

Fig. 122

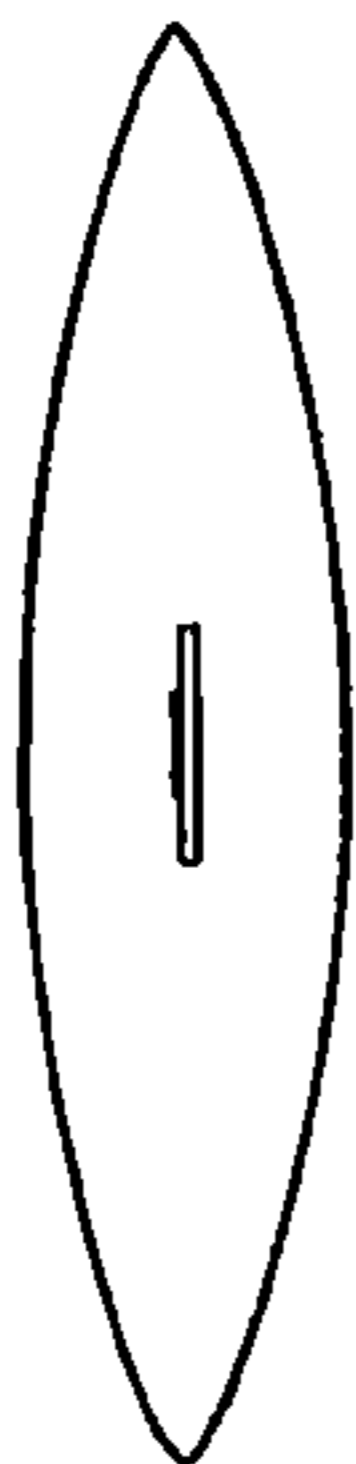

Fig. 123

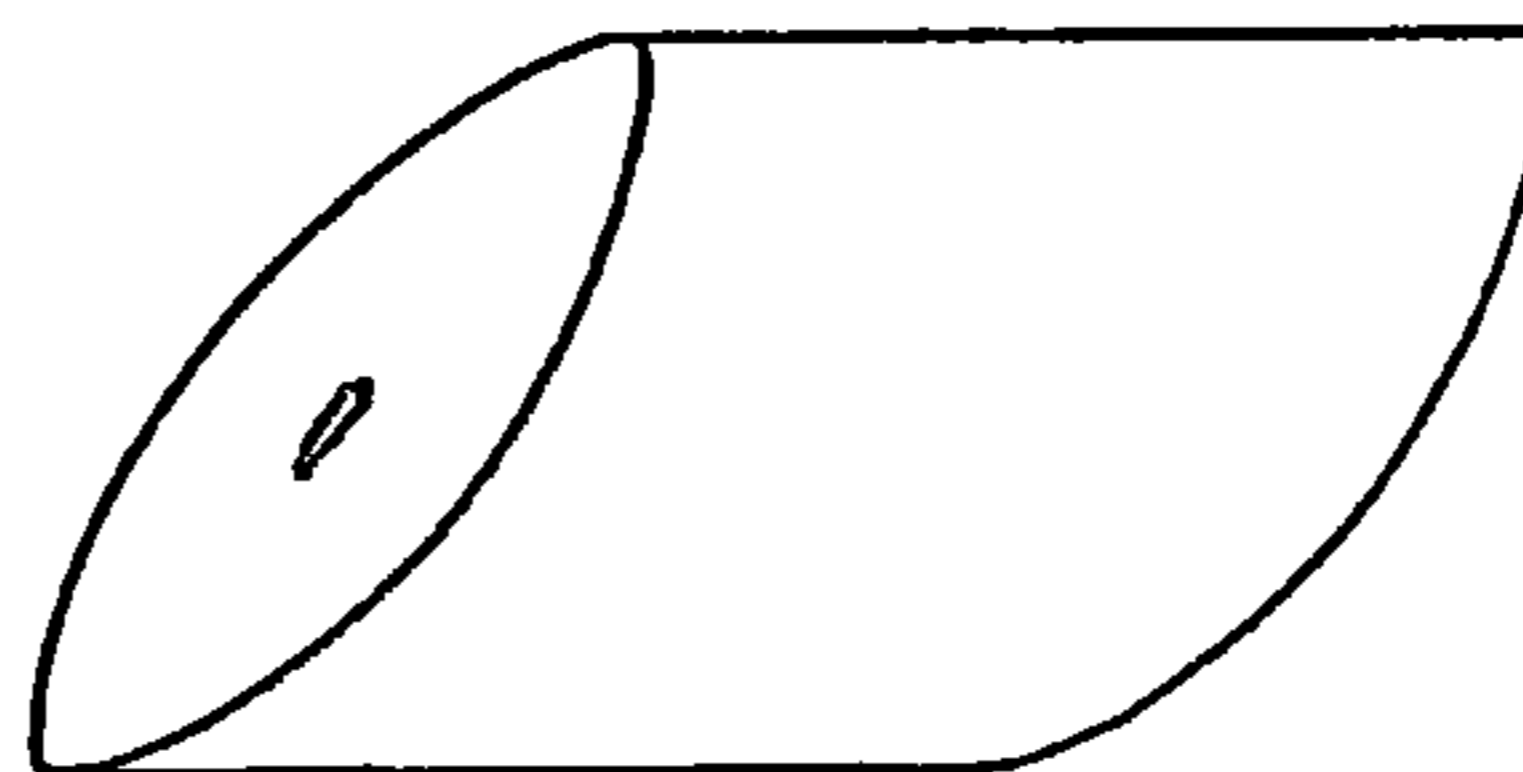

Fig. 124



Fig. 125

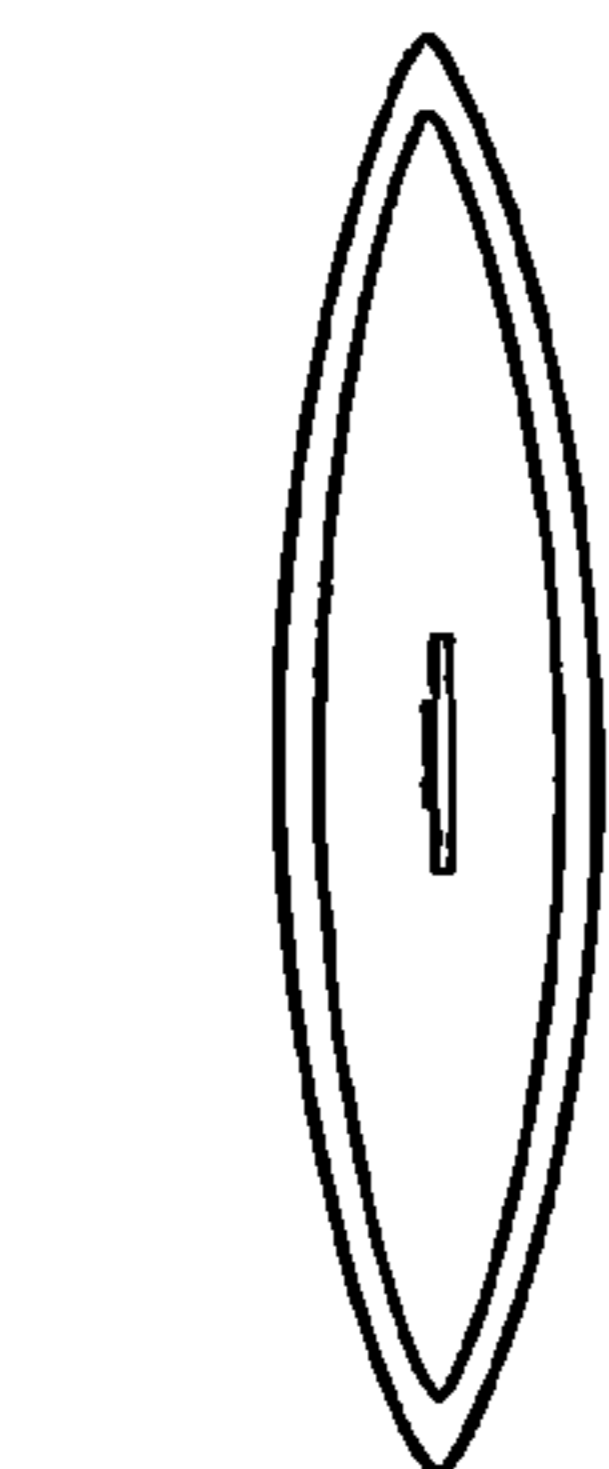

Fig. 128

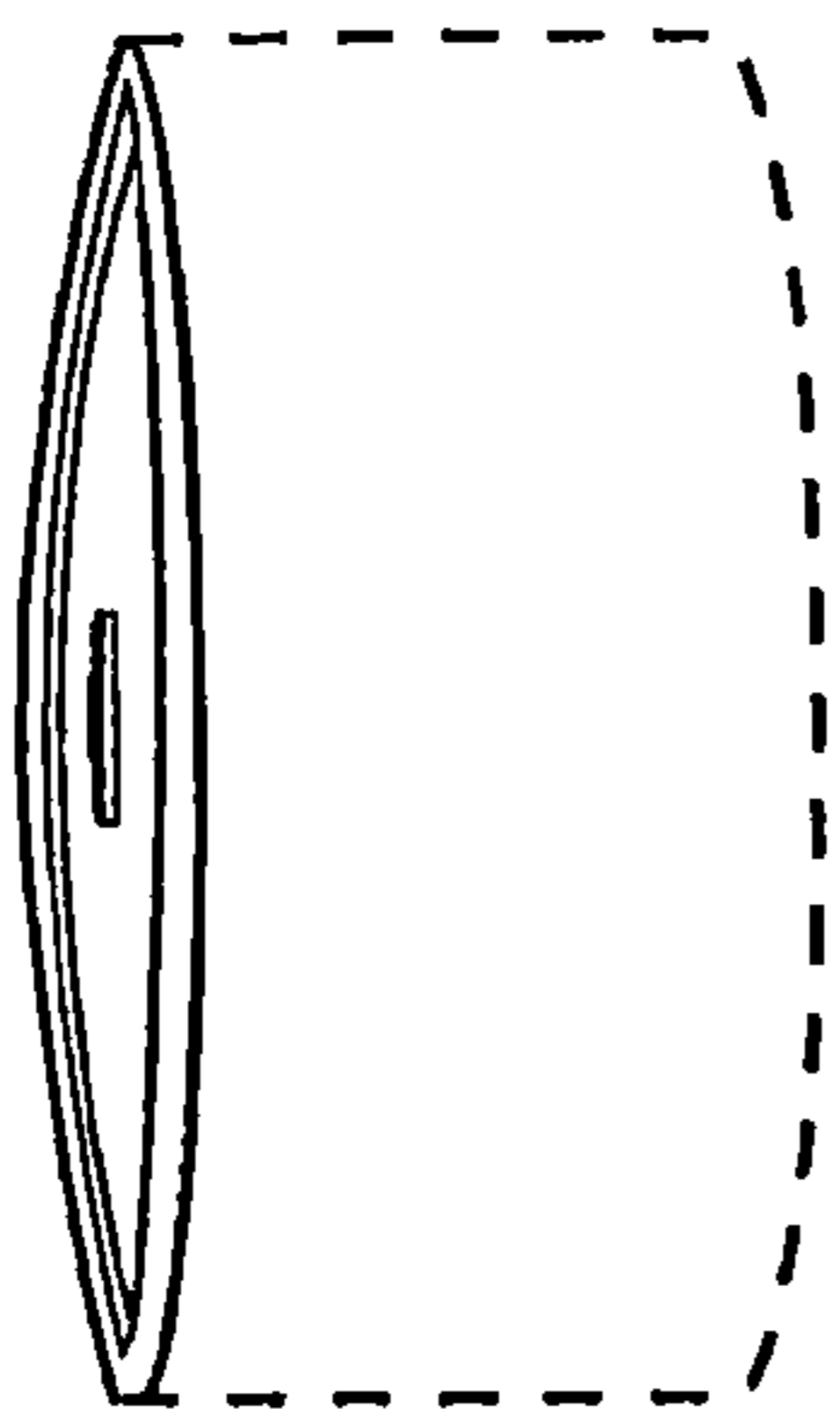

Fig. 127

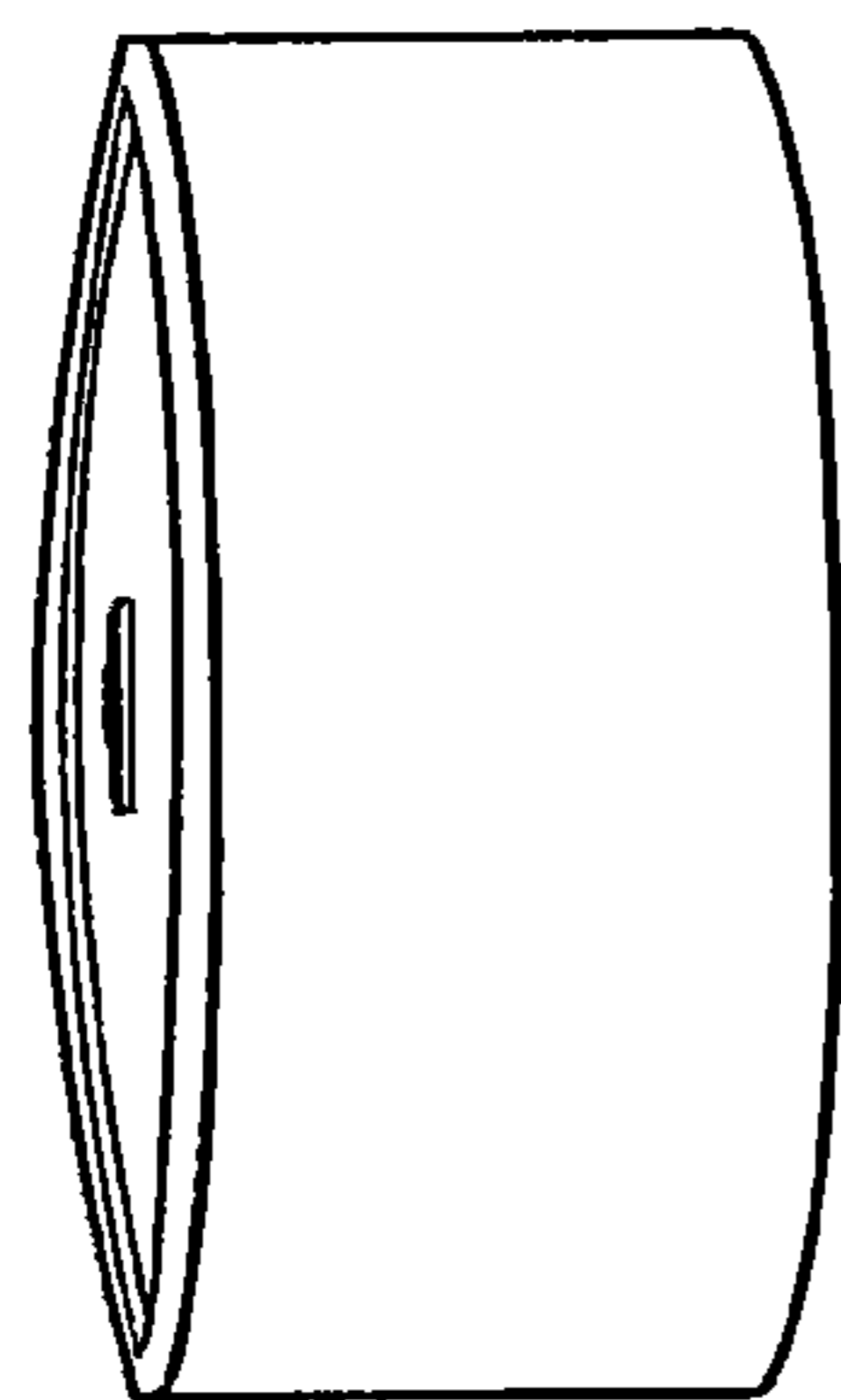

Fig. 126



Fig. 130

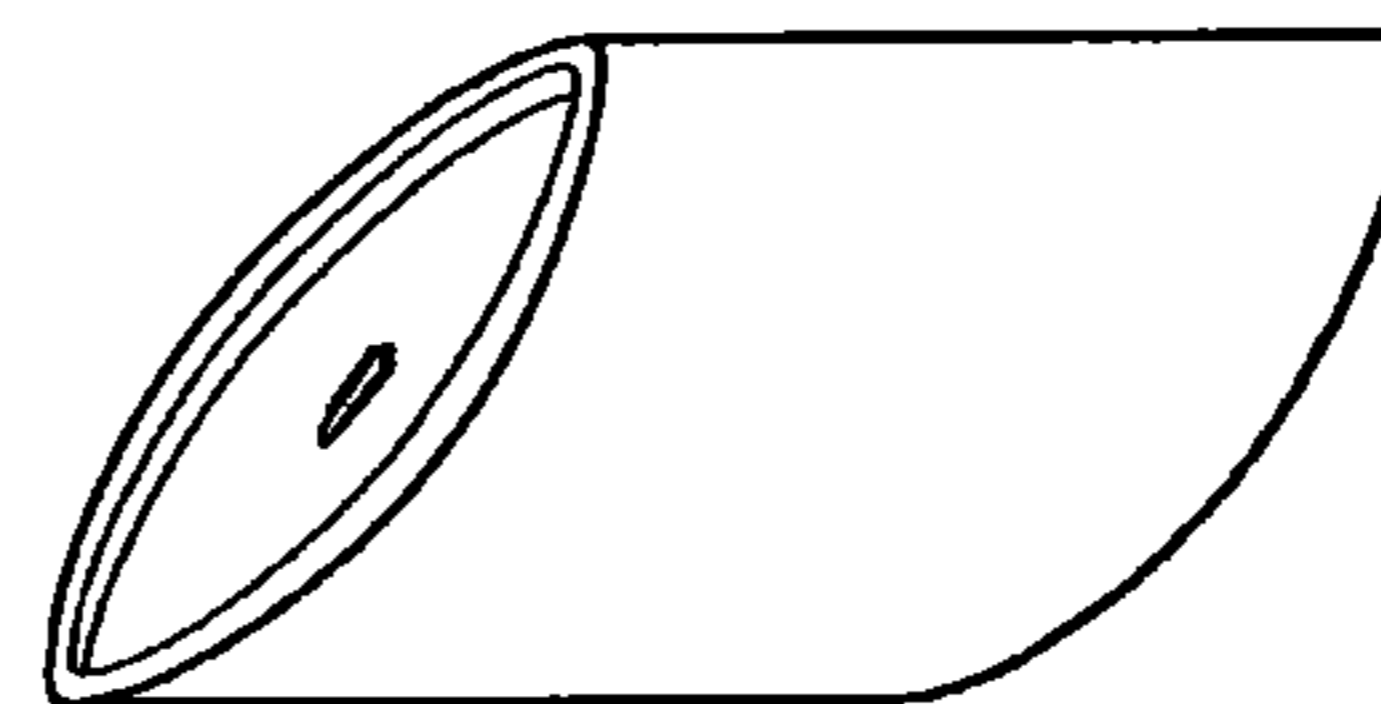

Fig. 129

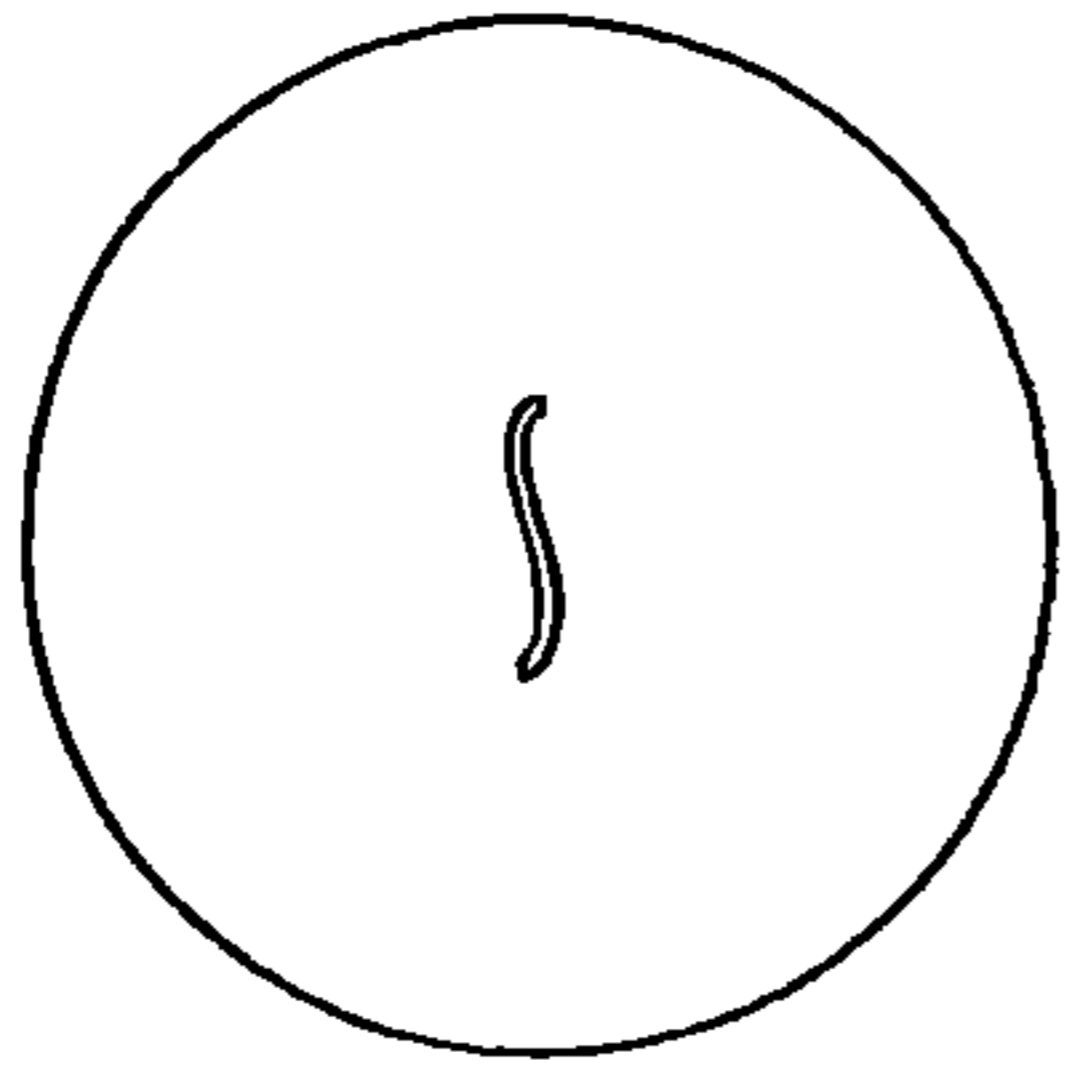

Fig. 133

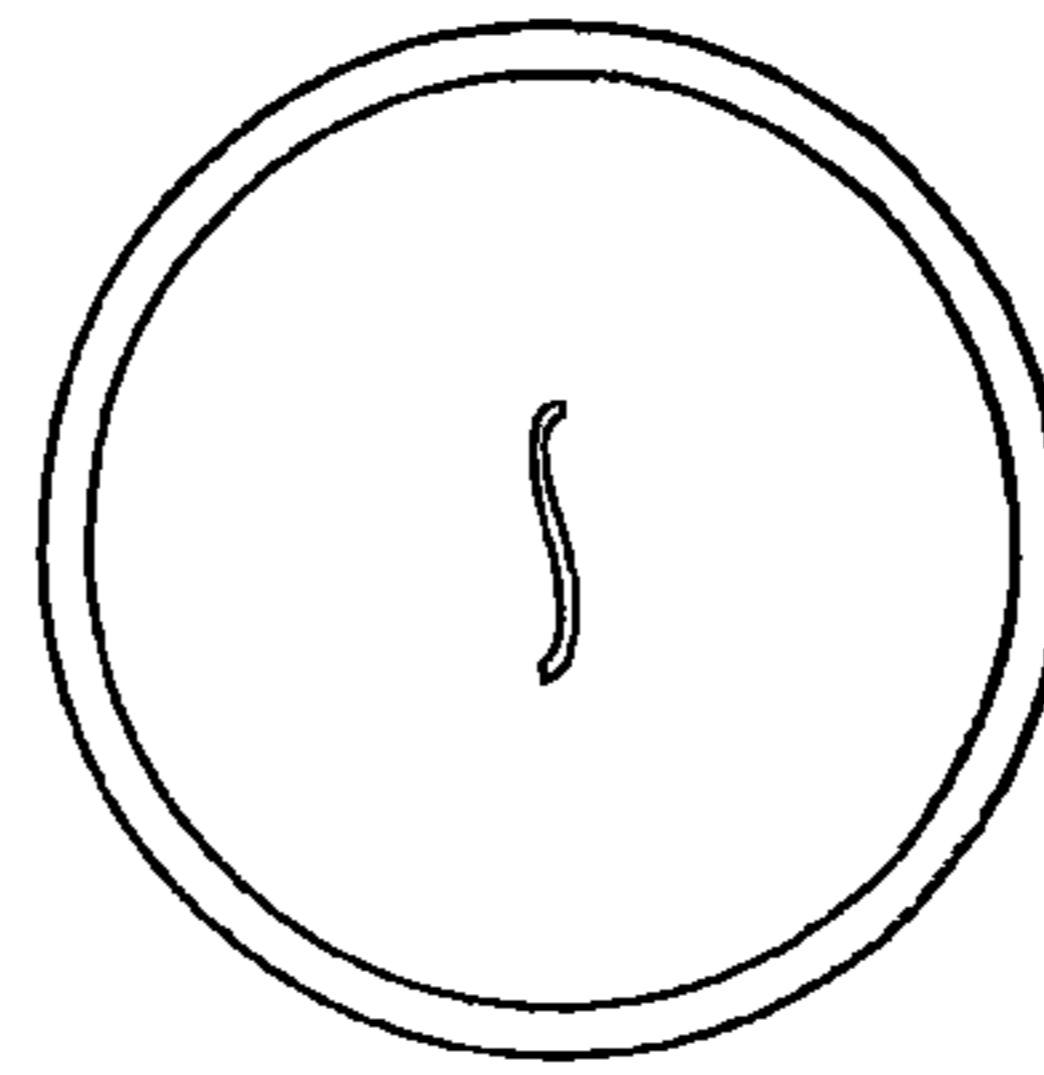

Fig. 136

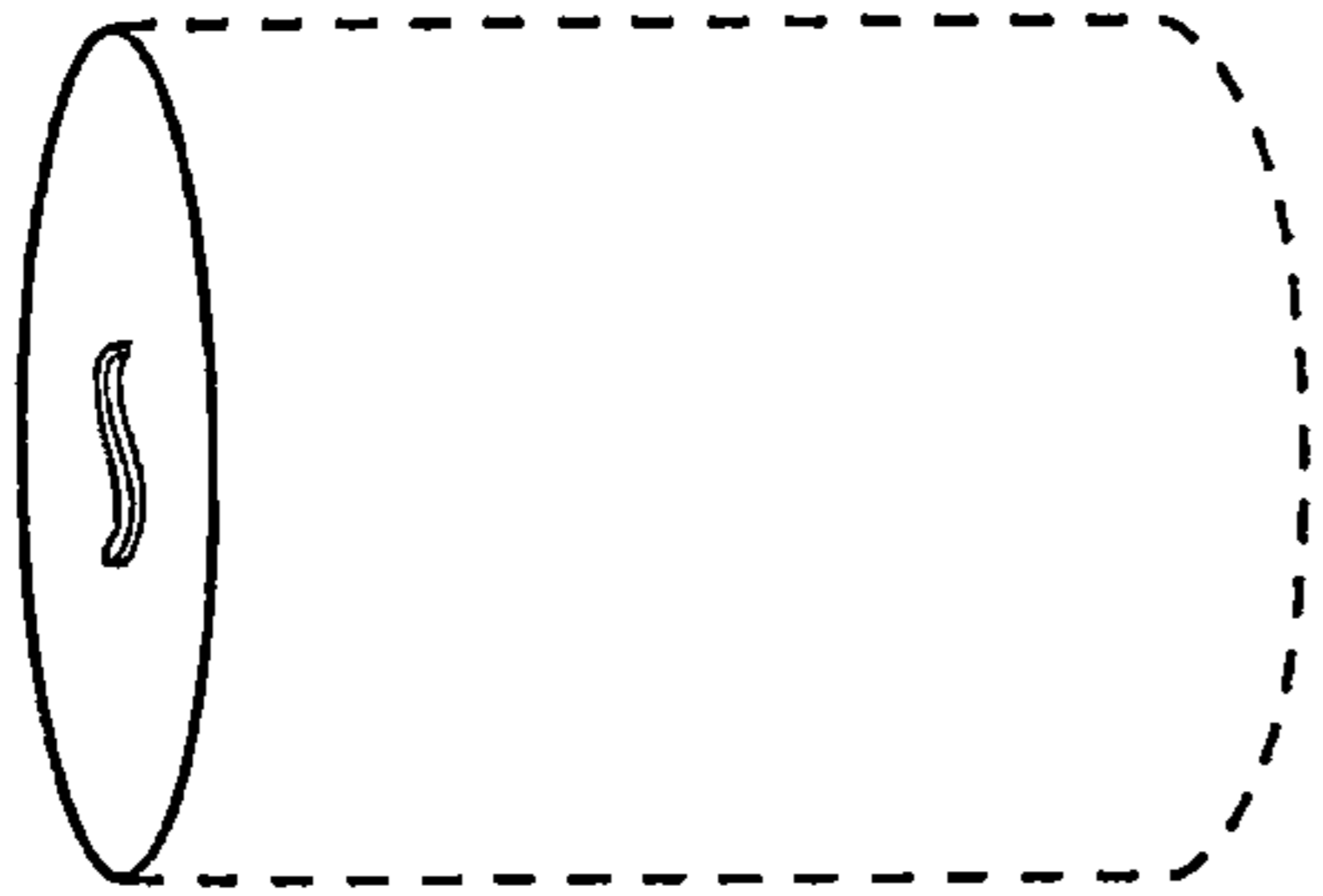

Fig. 132

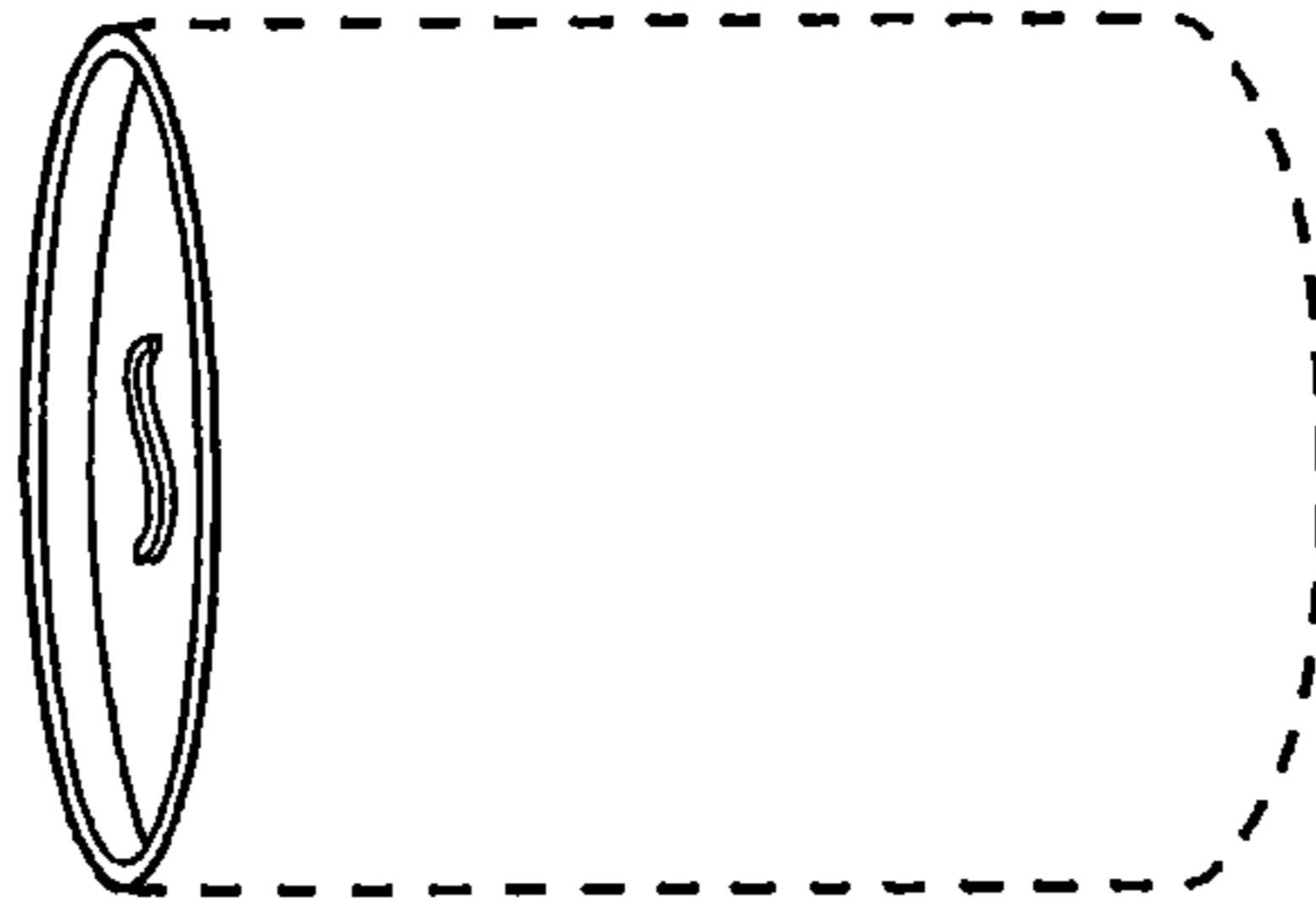

Fig. 135

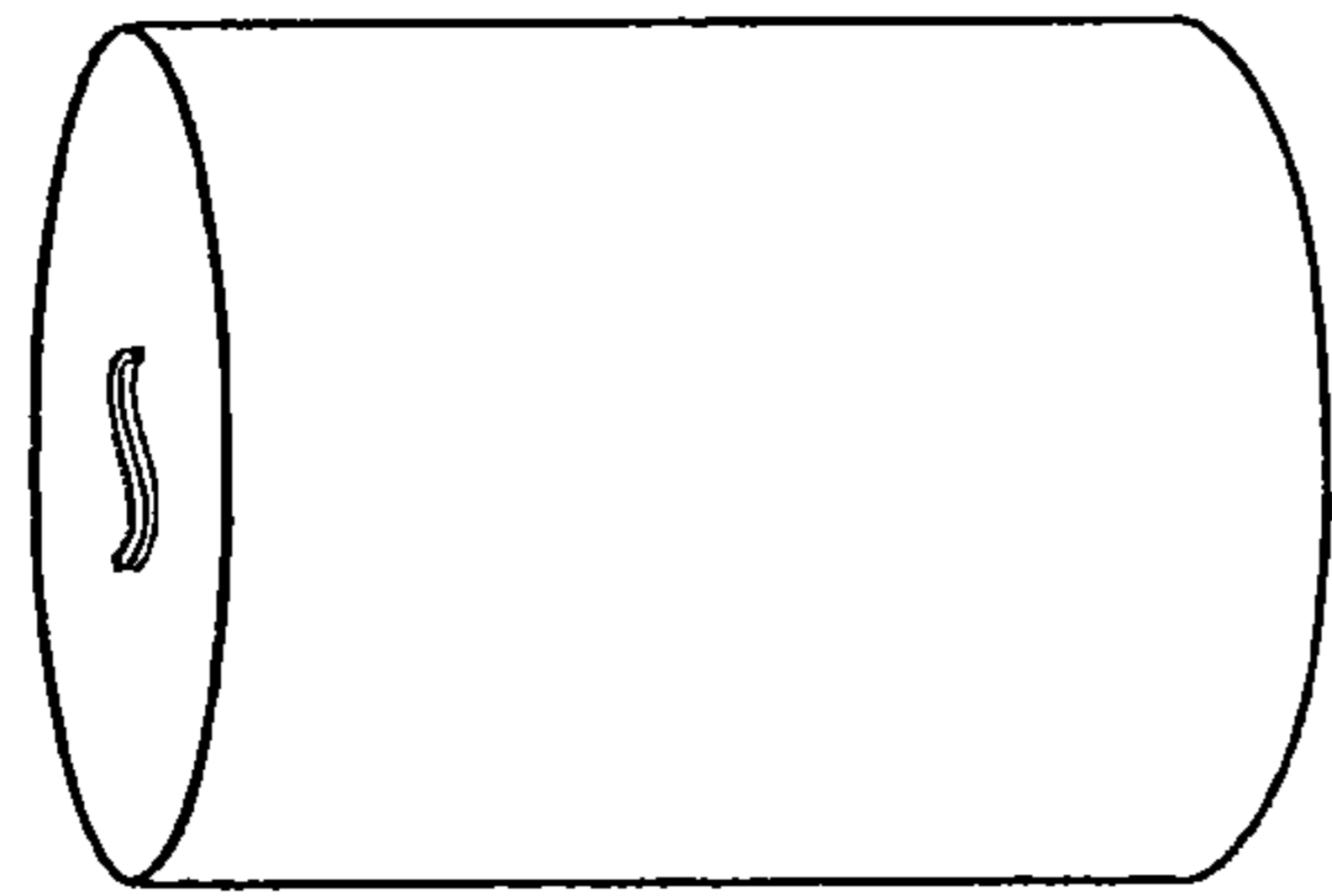

Fig. 131

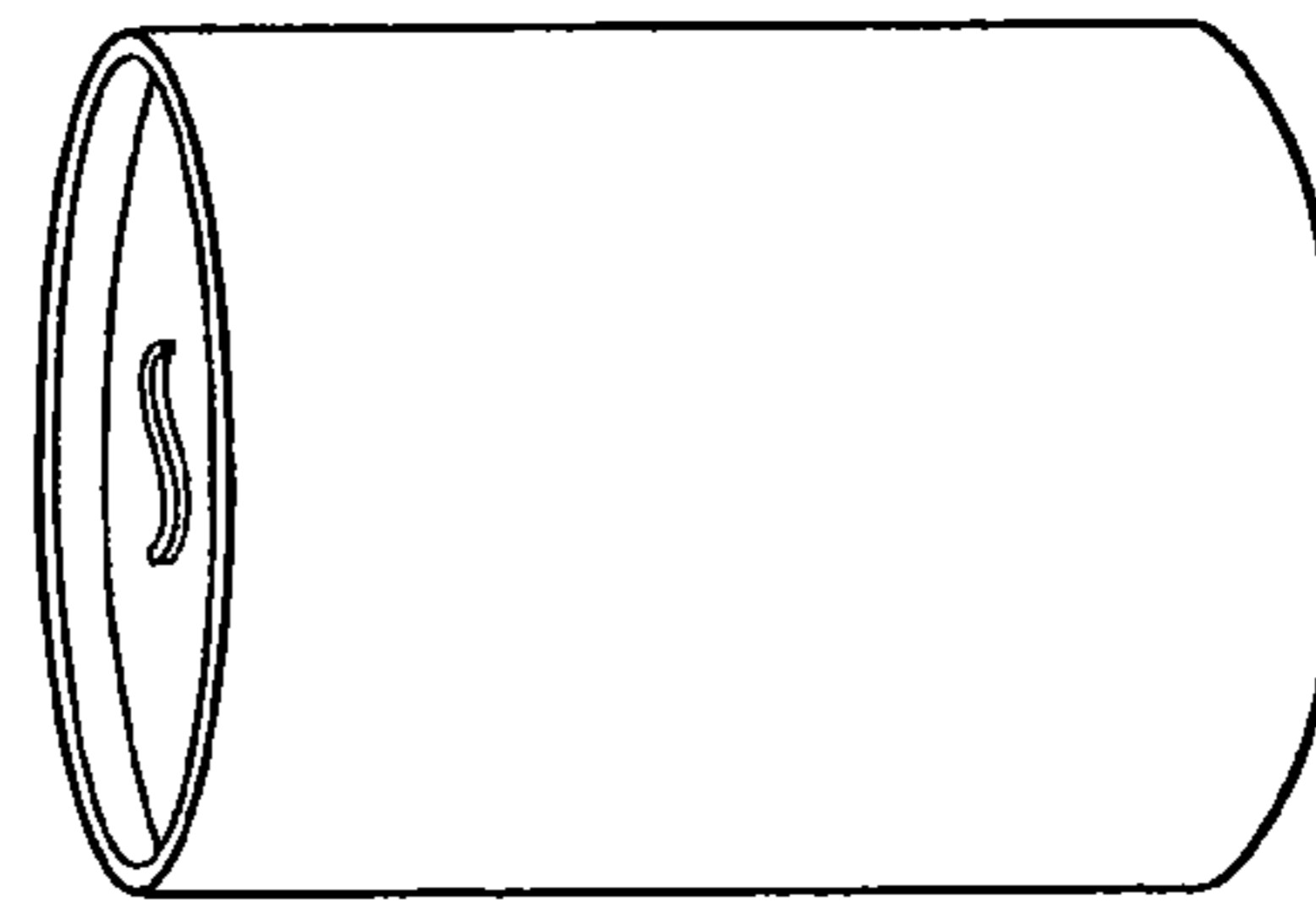

Fig. 134

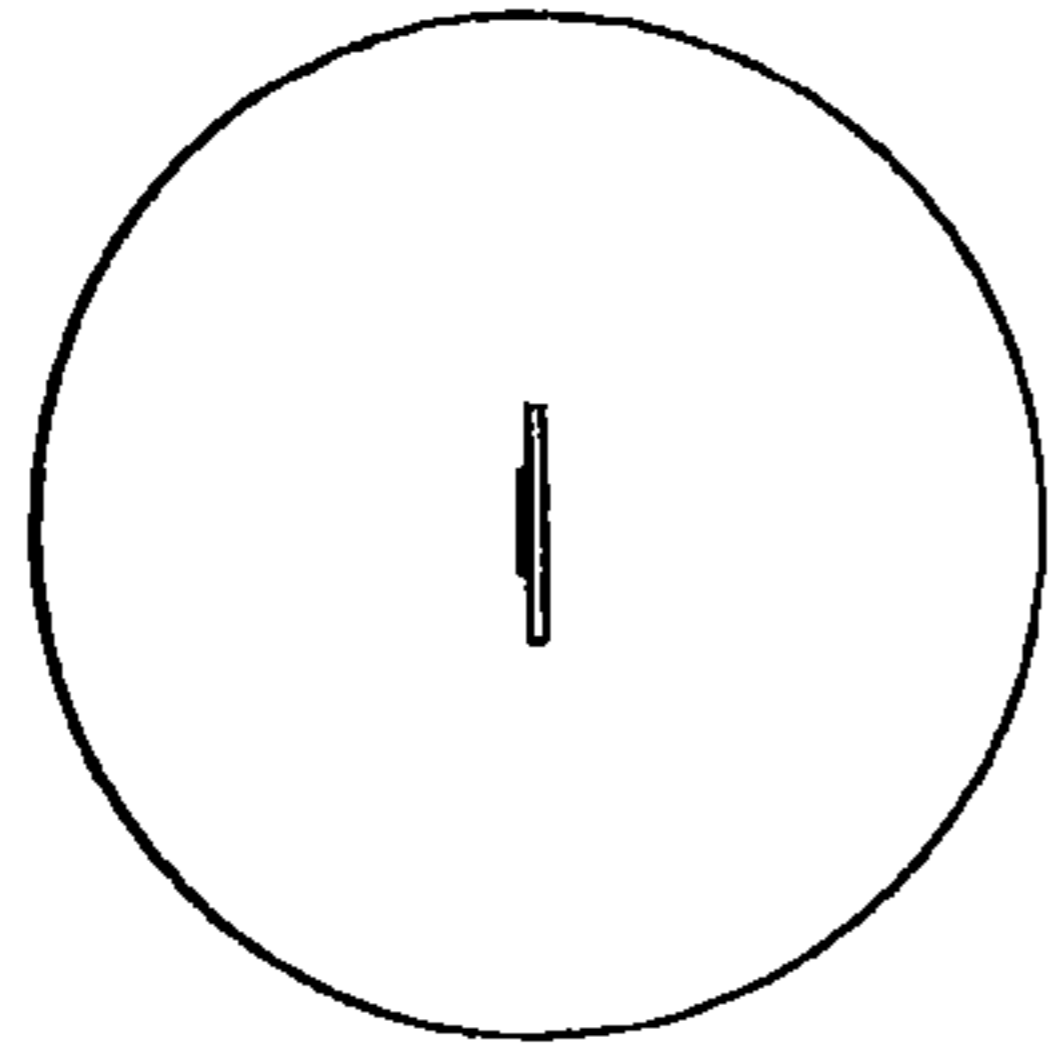

Fig. 139

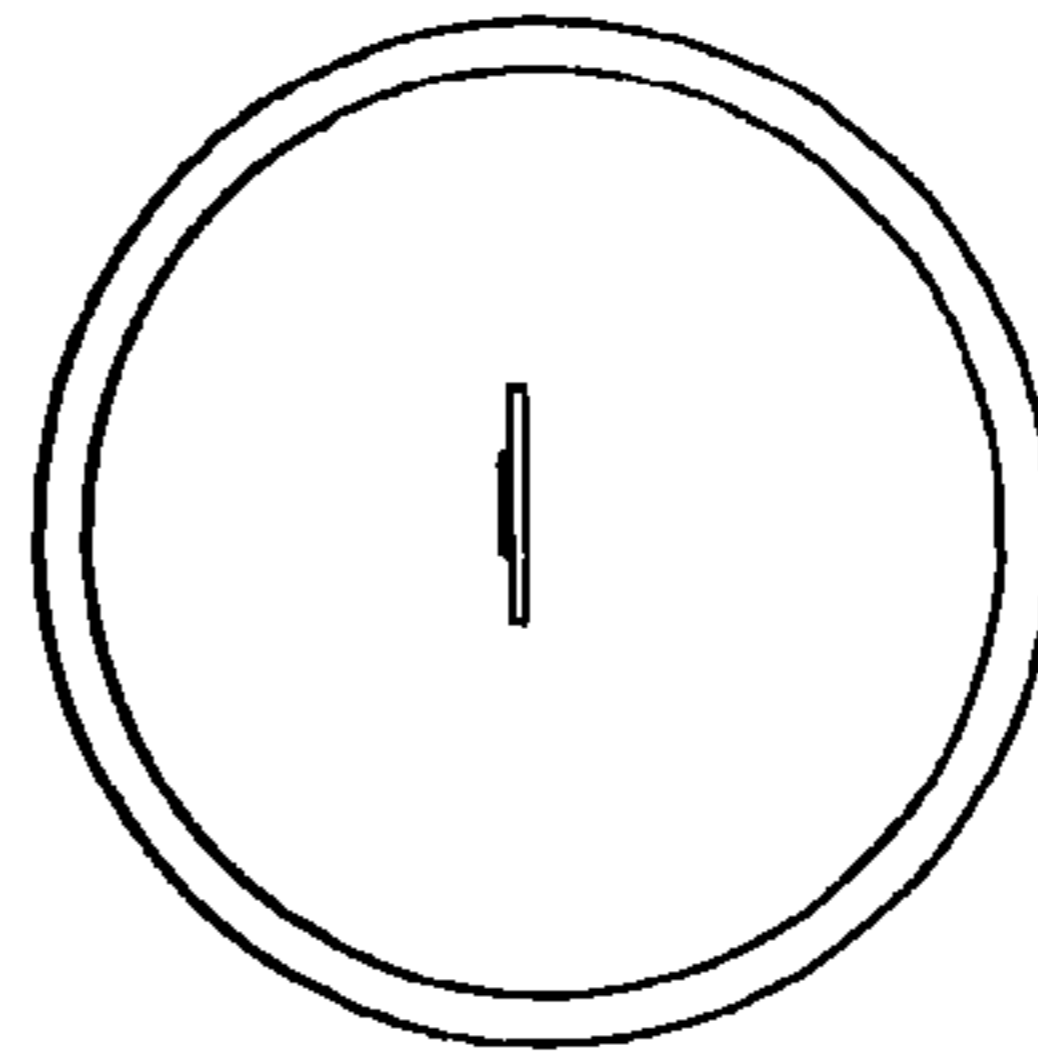

Fig. 142

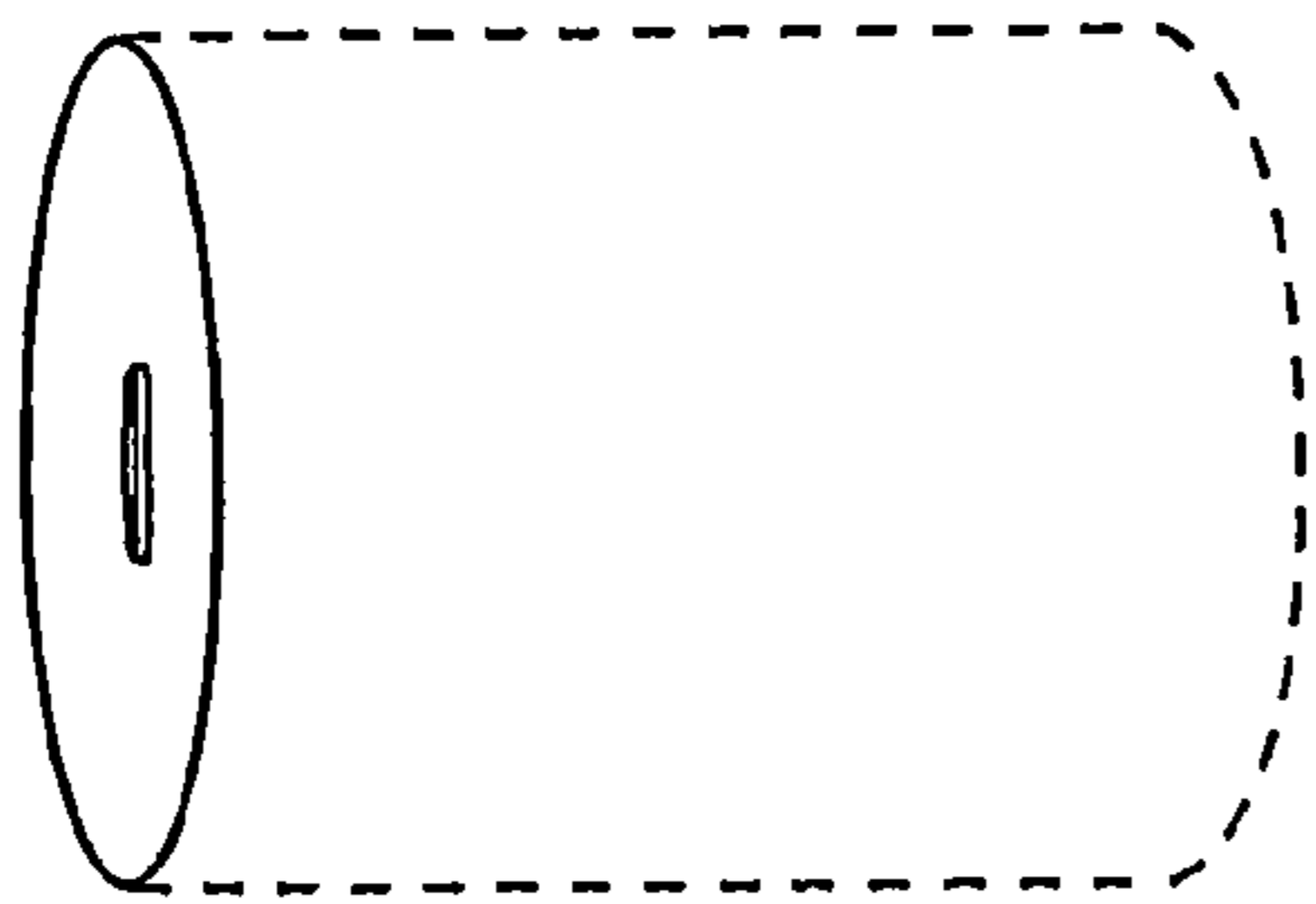

Fig. 138

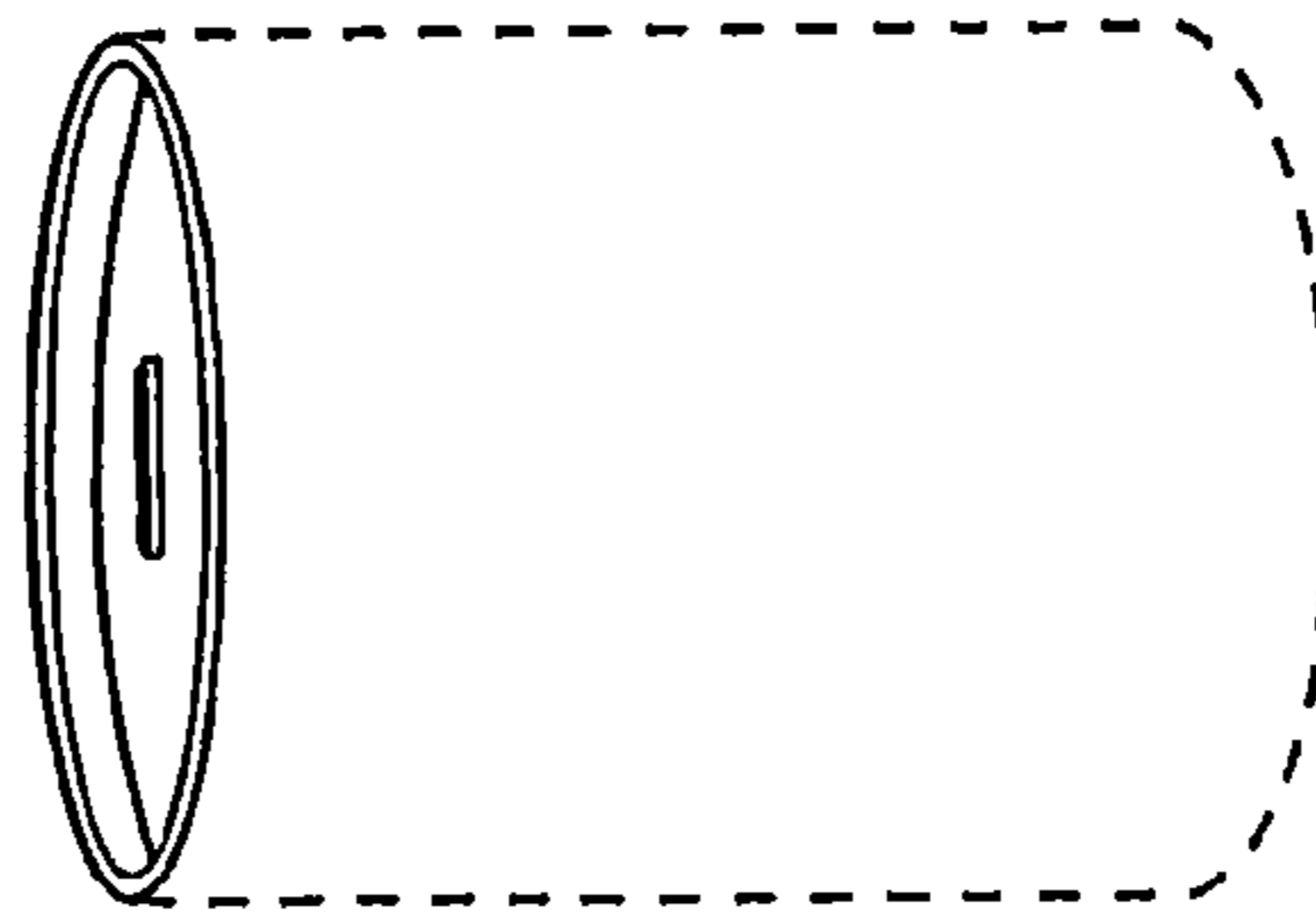

Fig. 141

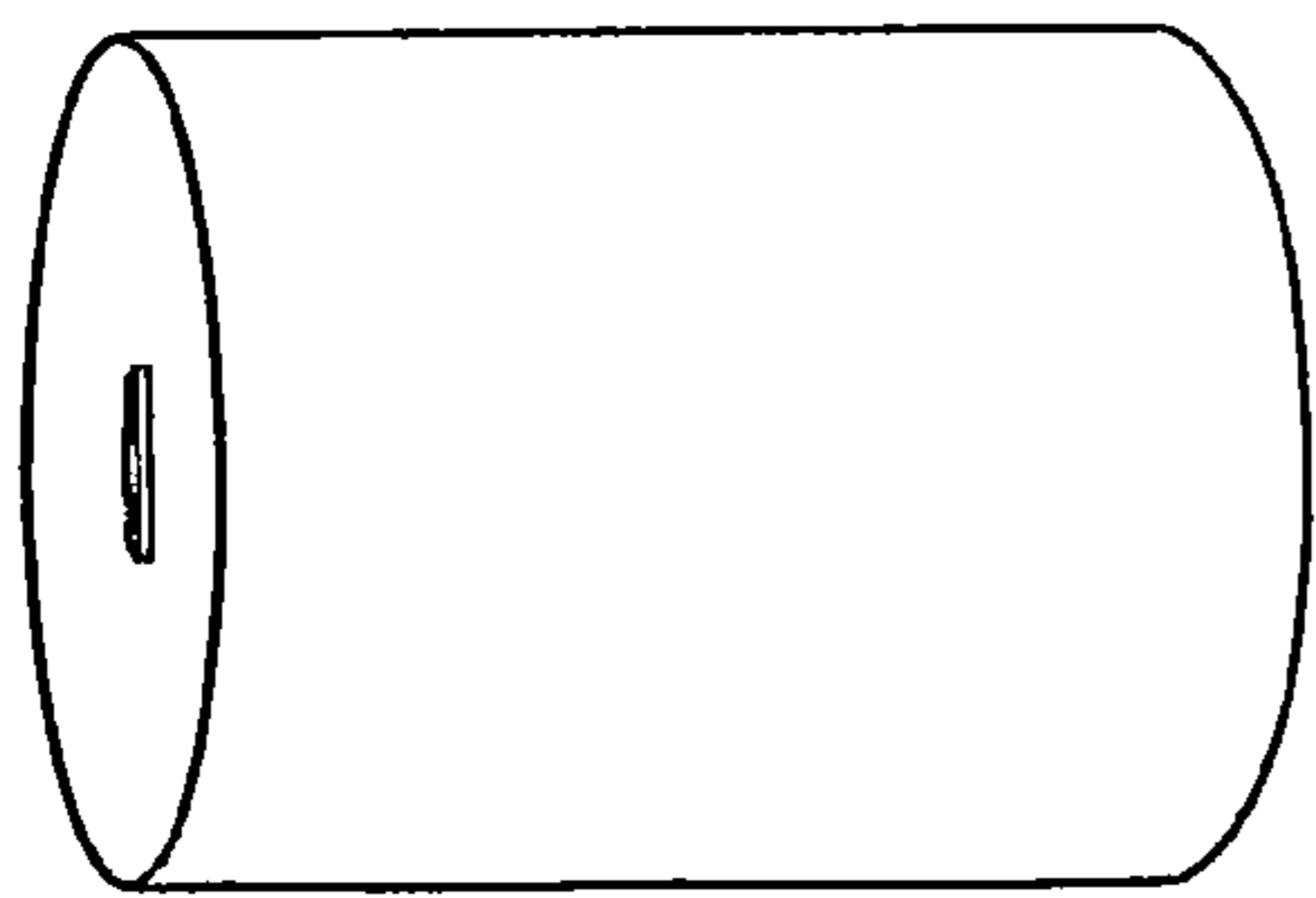

Fig. 137

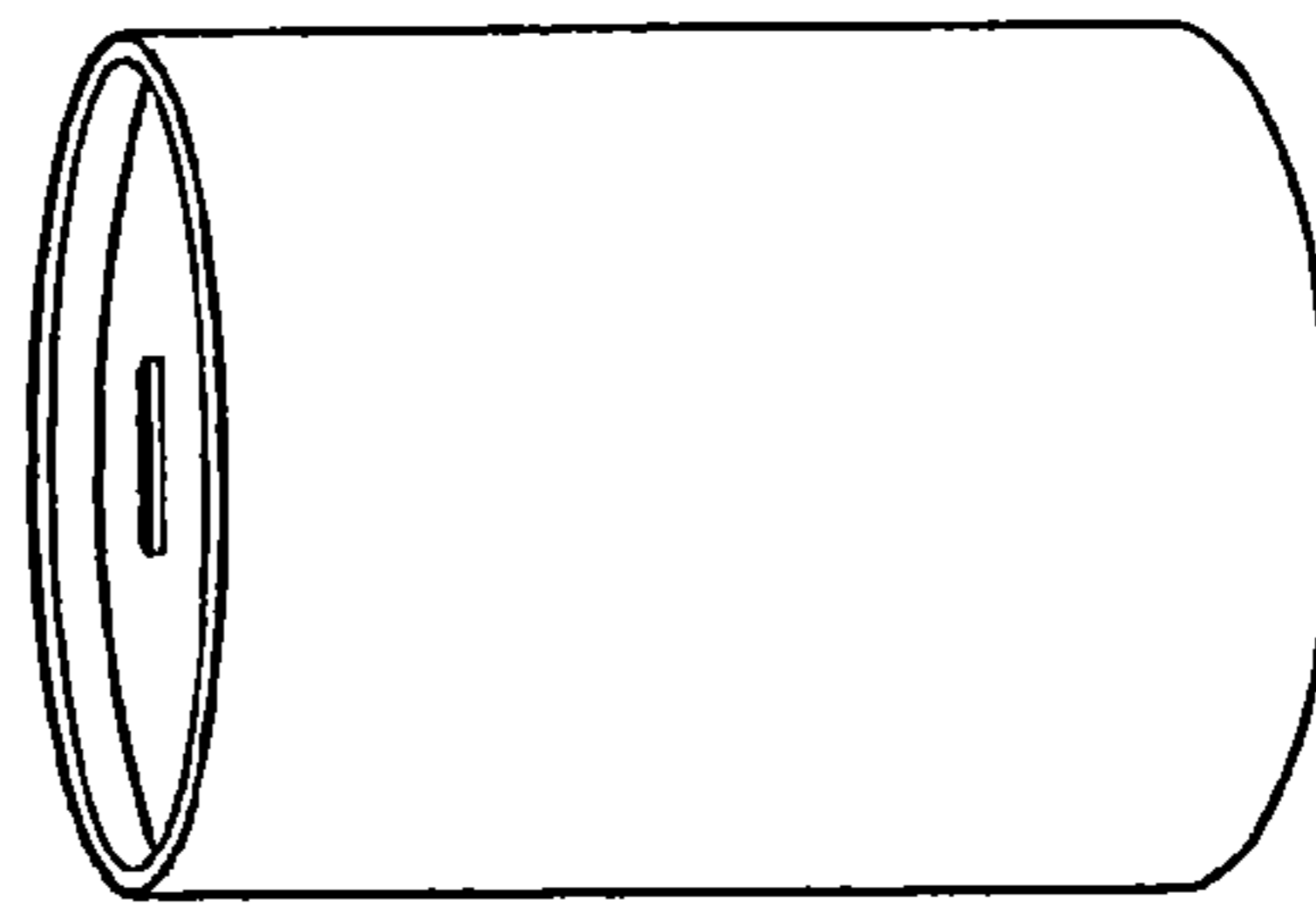

Fig. 140

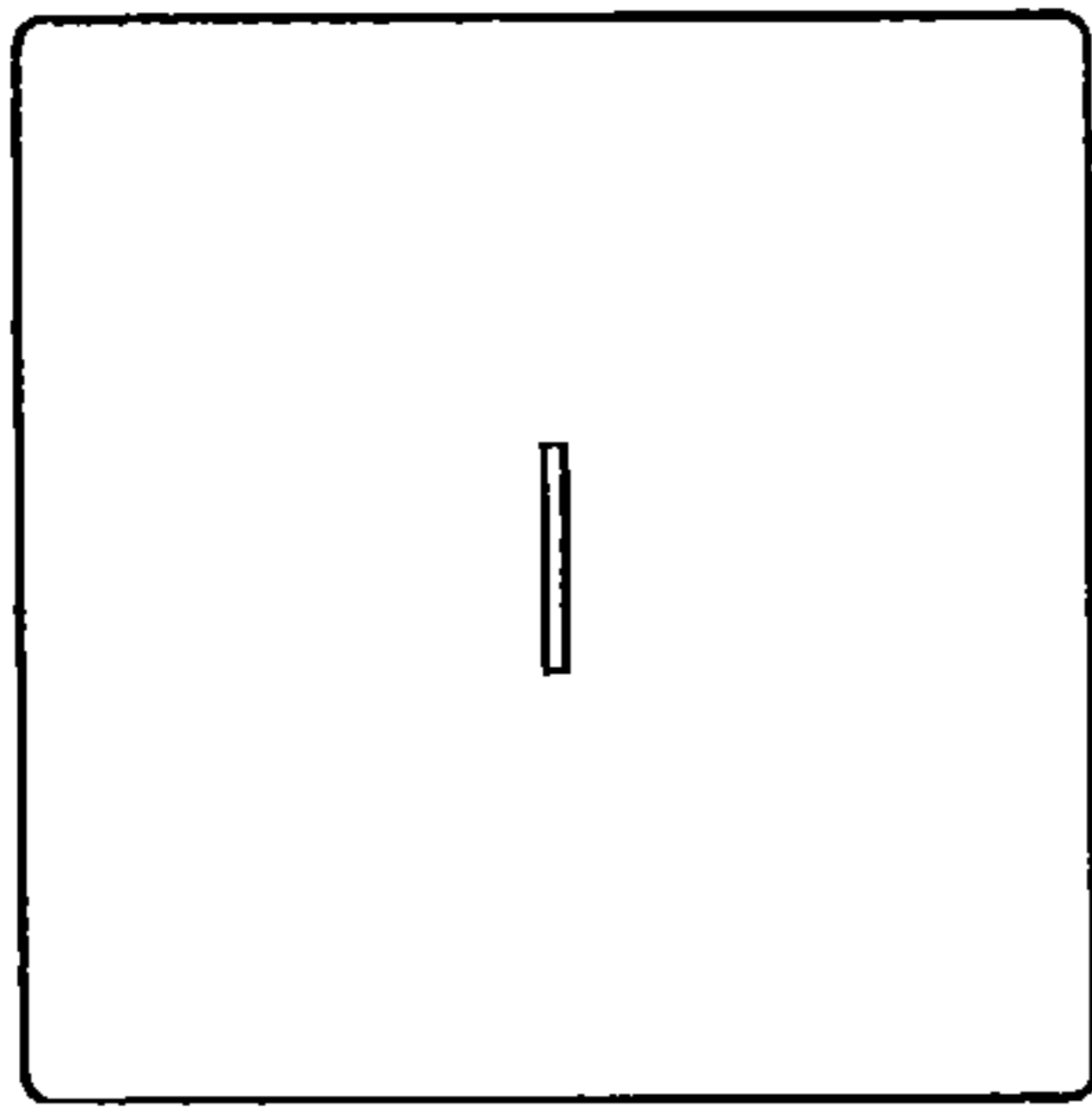

Fig. 145

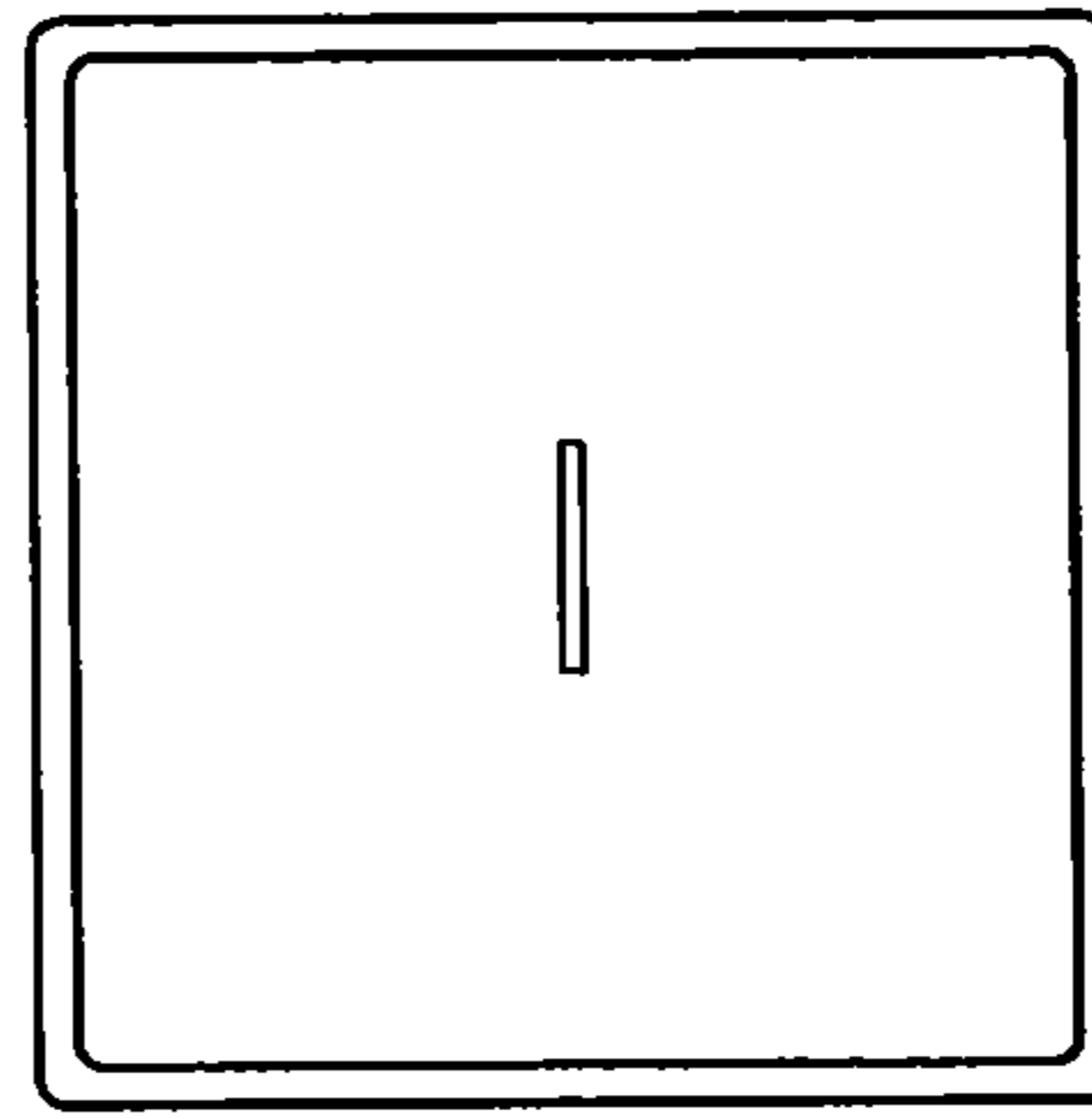

Fig. 148

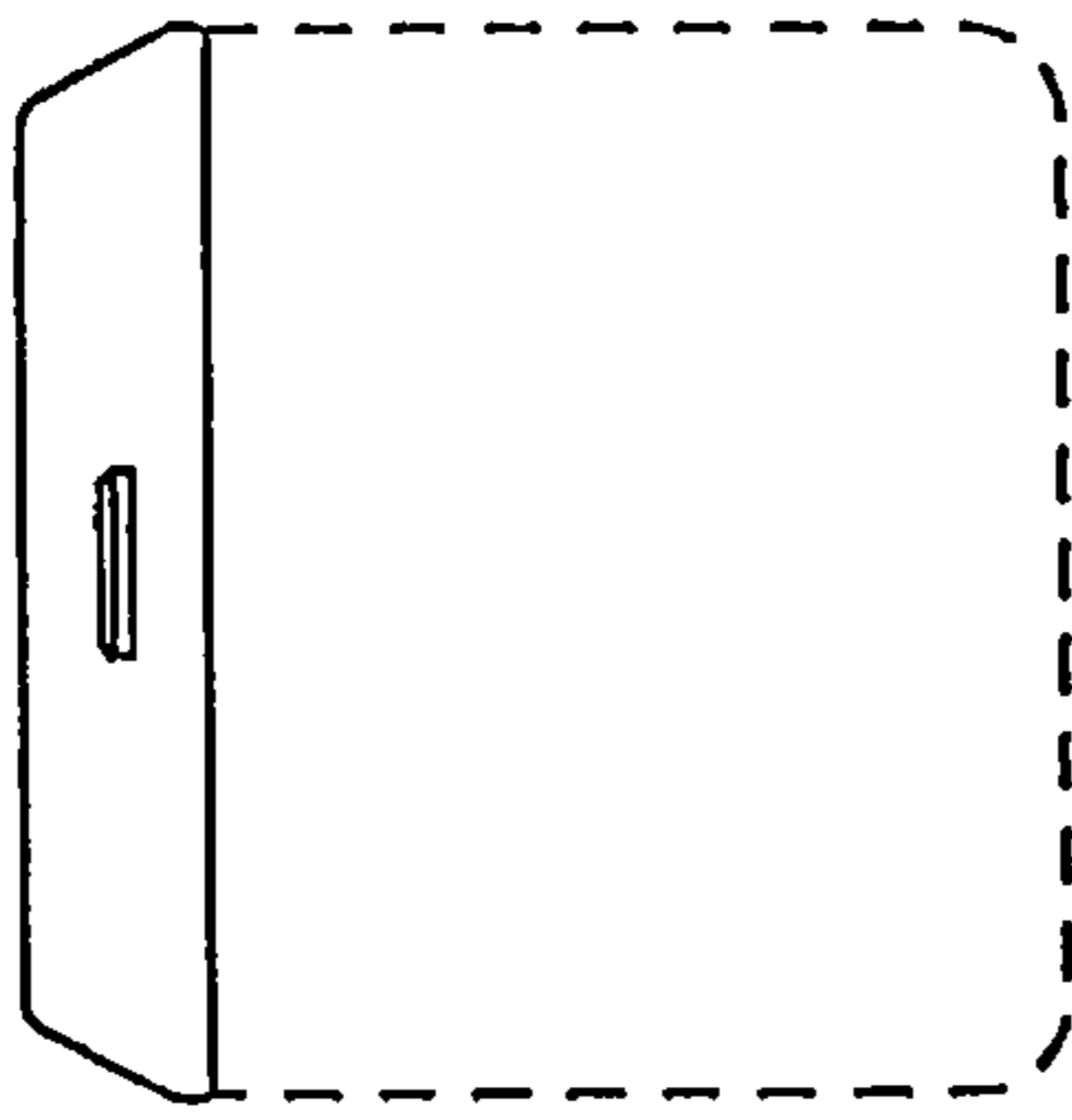

Fig. 144

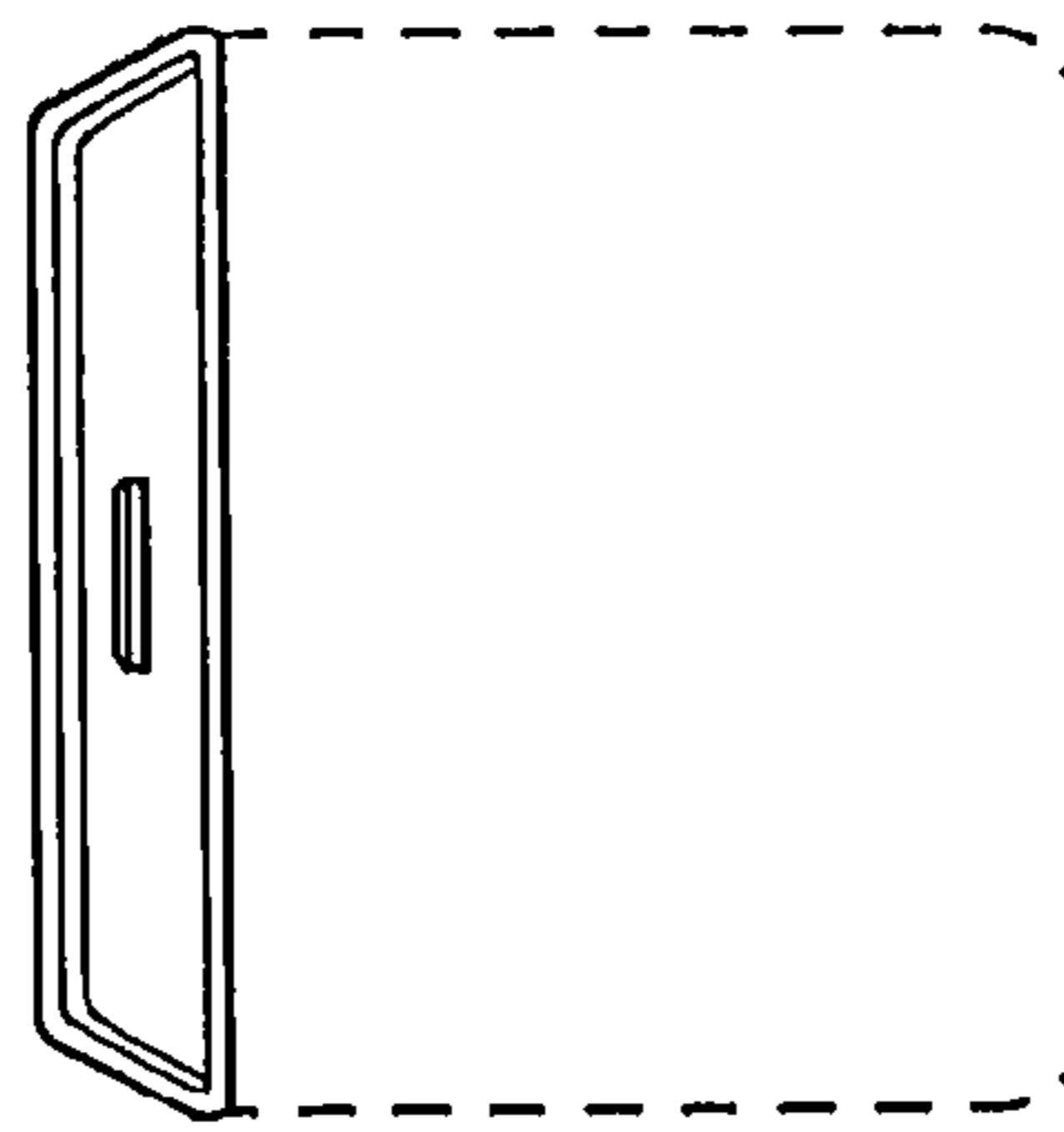

Fig. 147

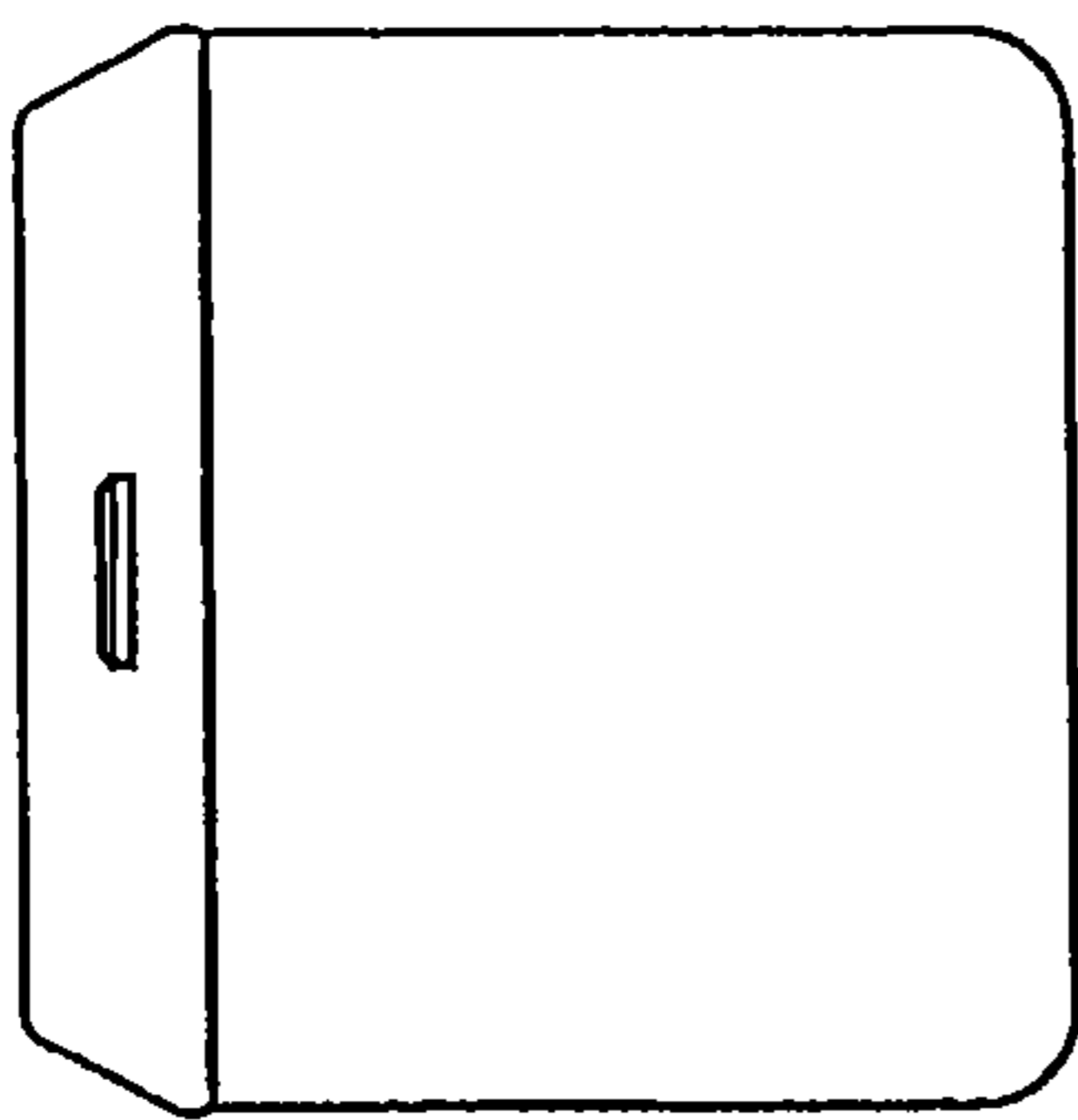

Fig. 143

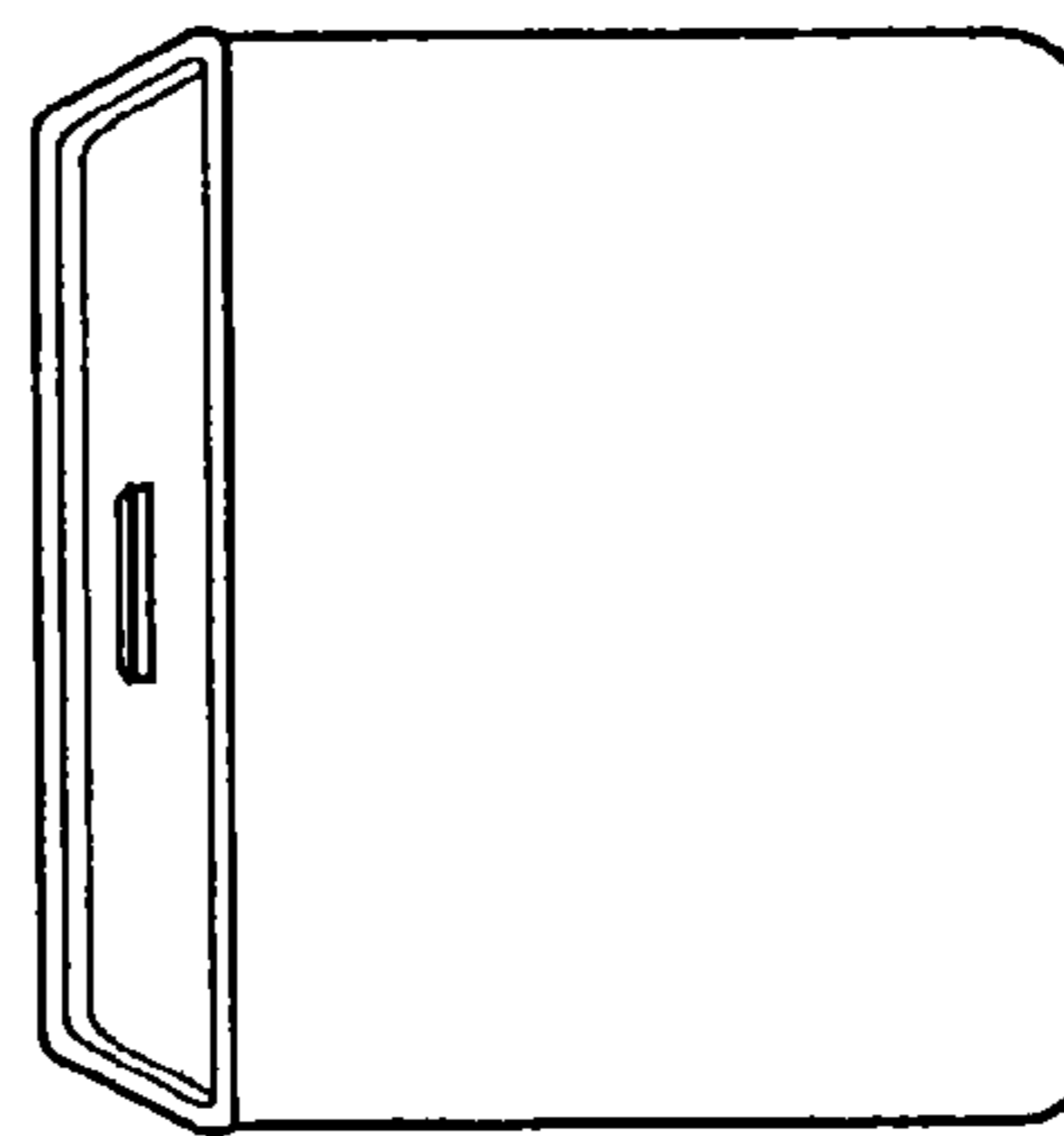

Fig. 146

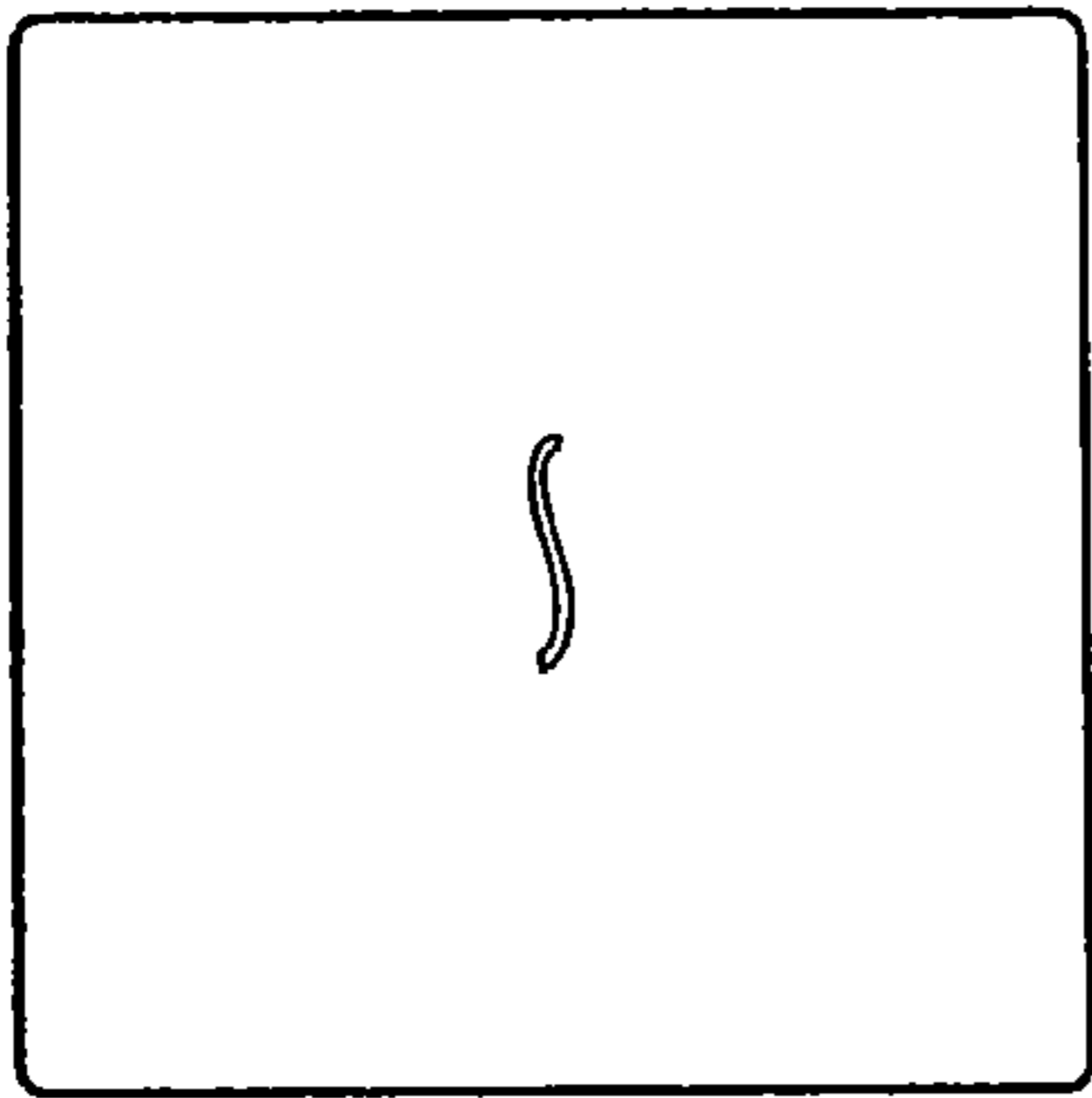

Fig. 149

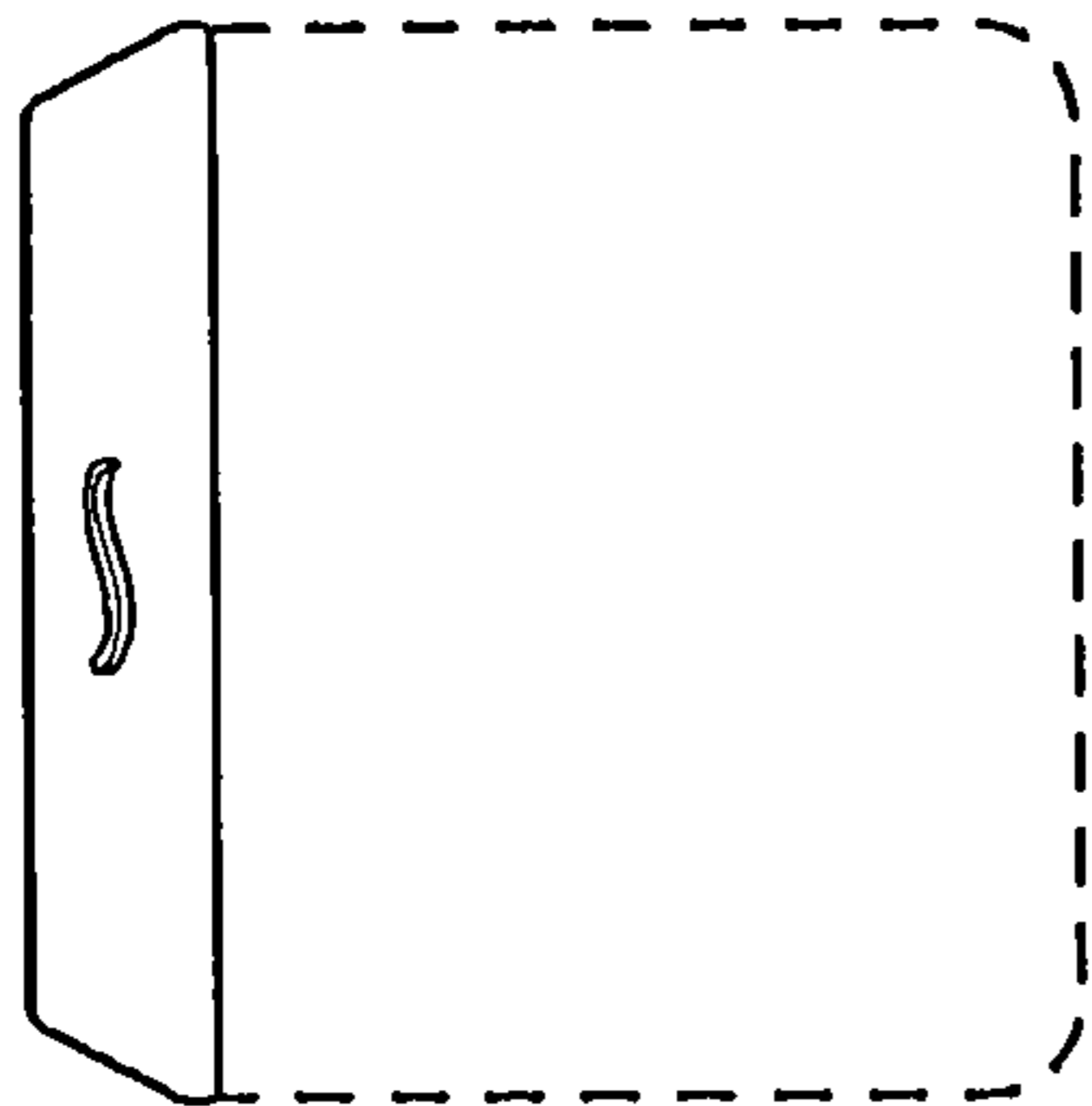

Fig. 150

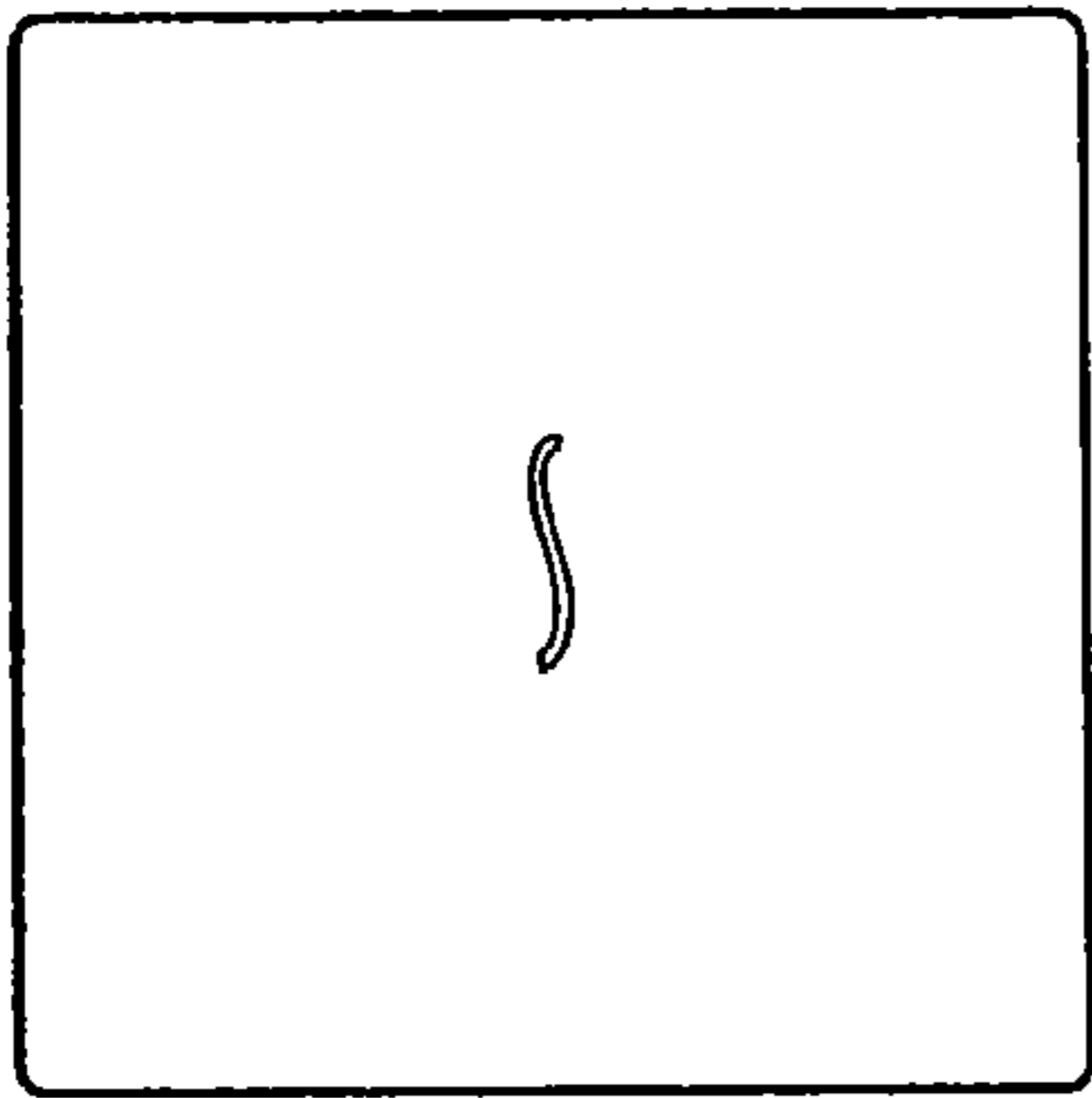

Fig. 151

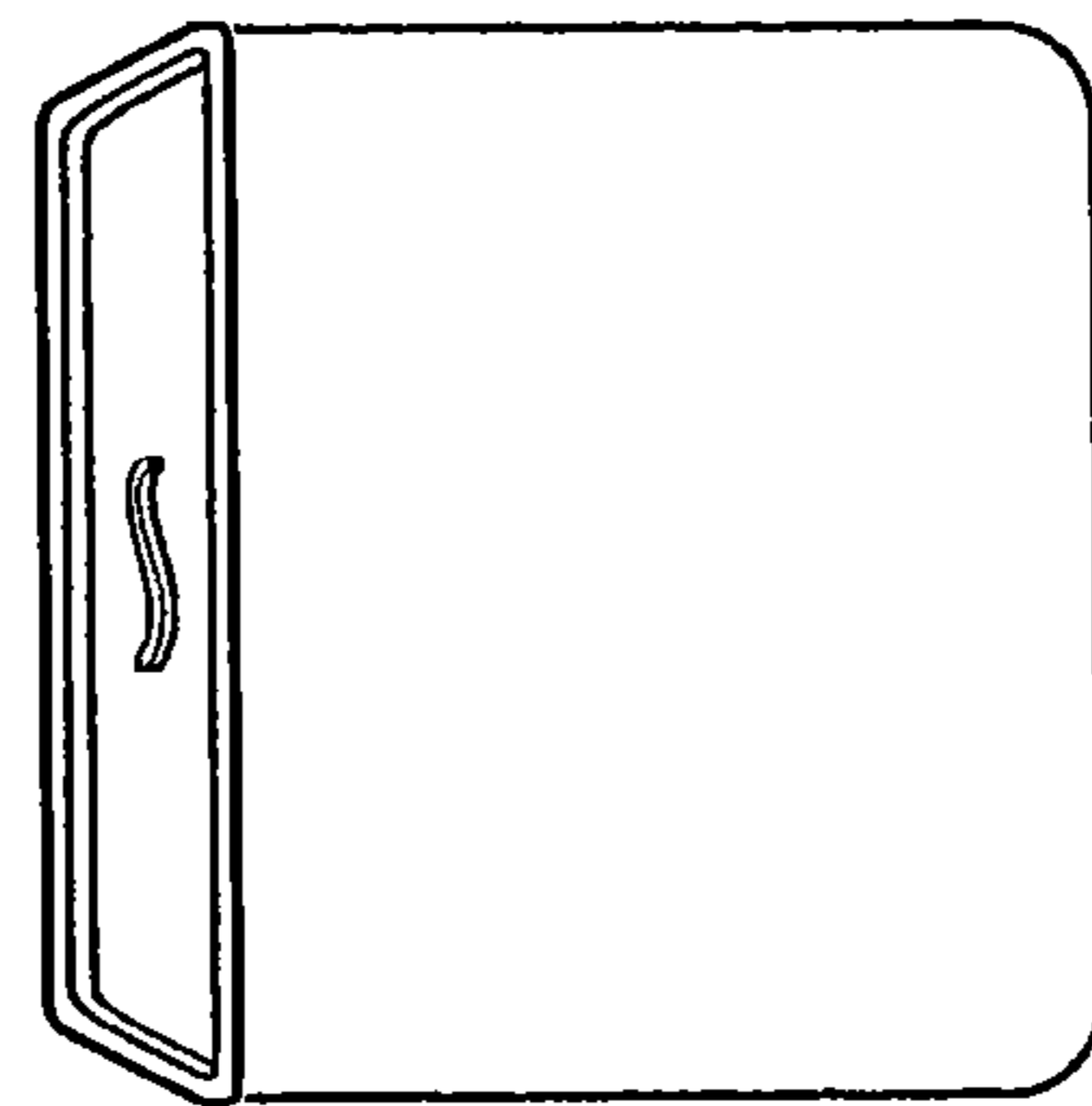

Fig. 152

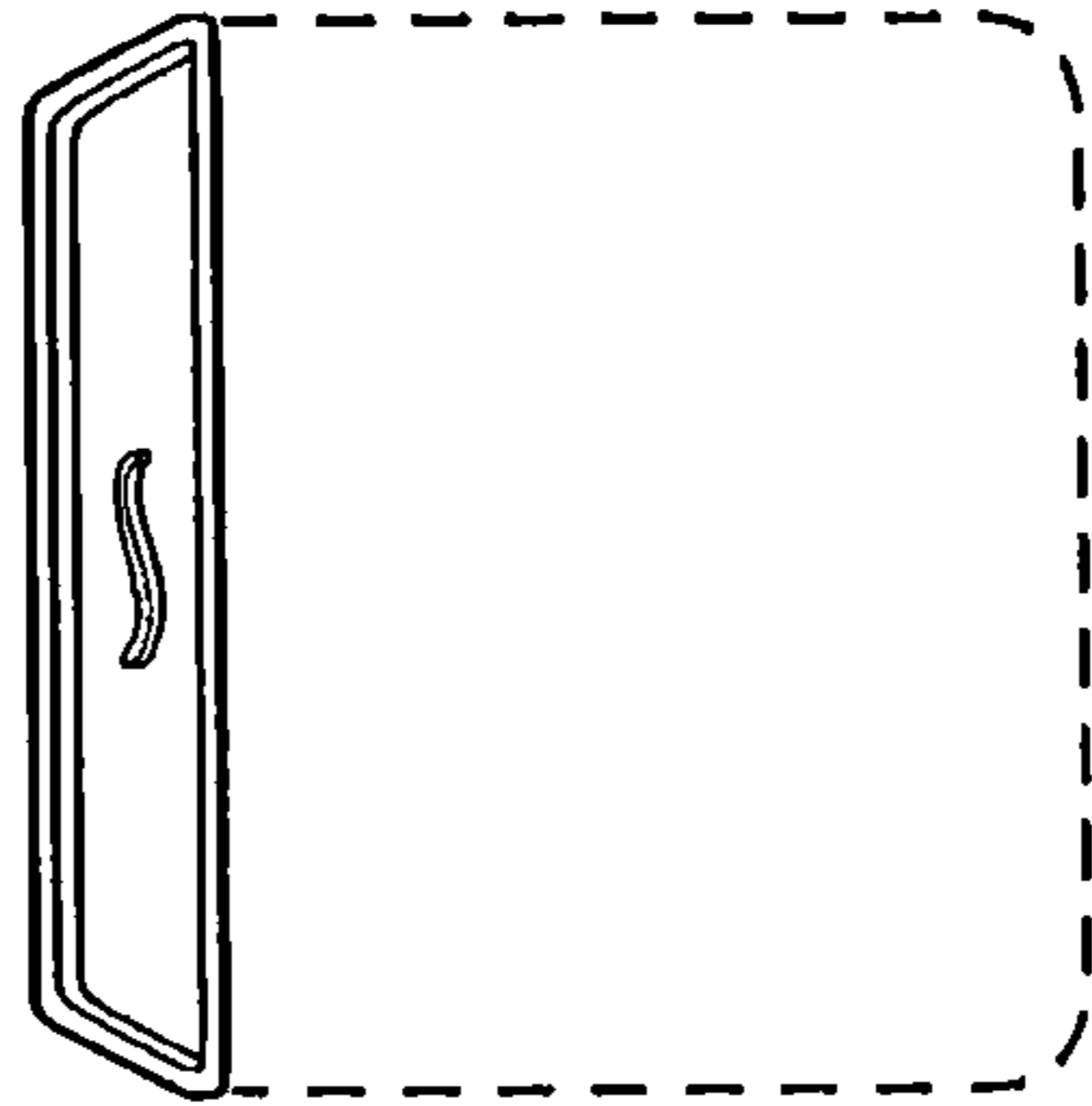

Fig. 153

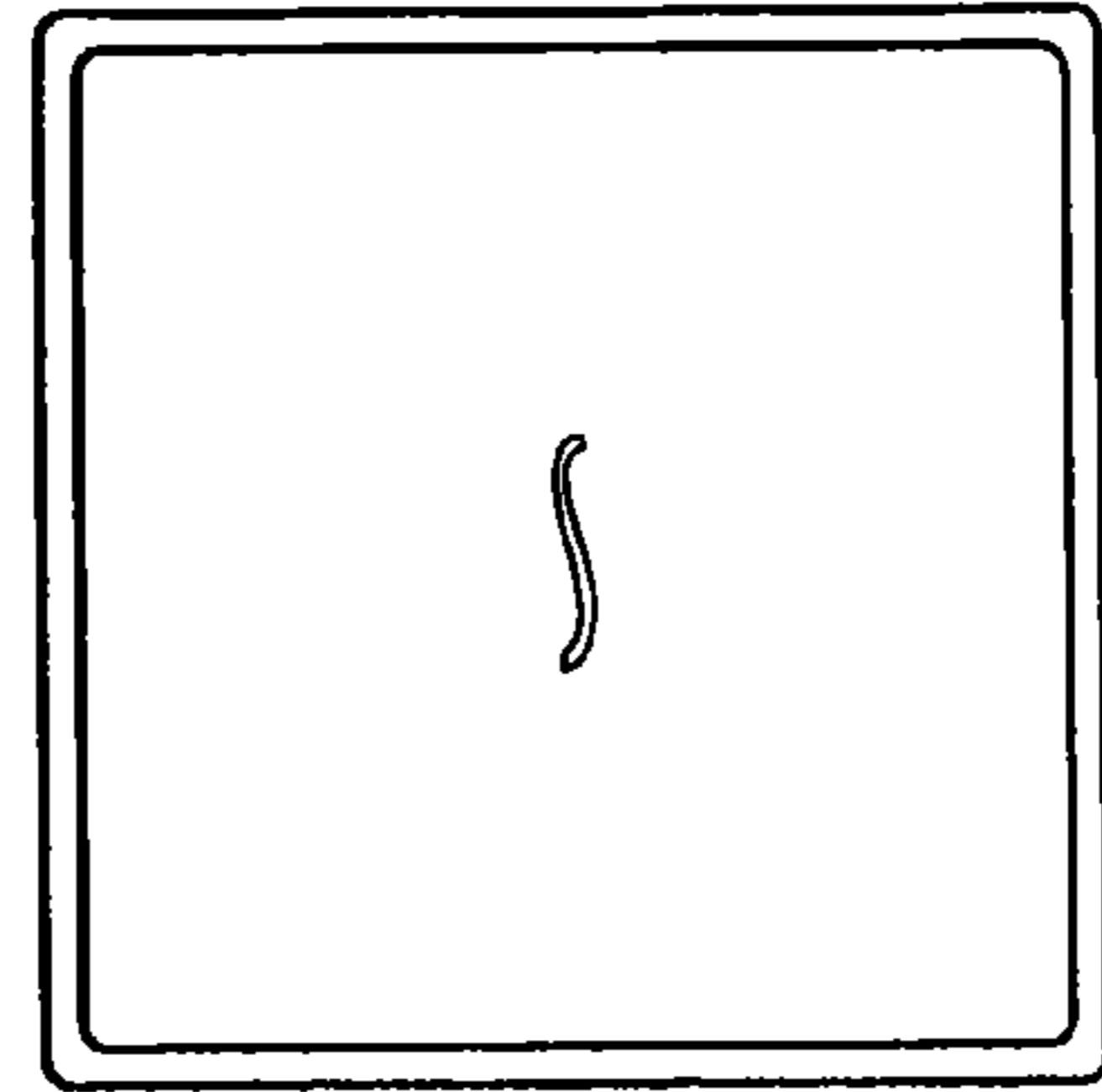

Fig. 154

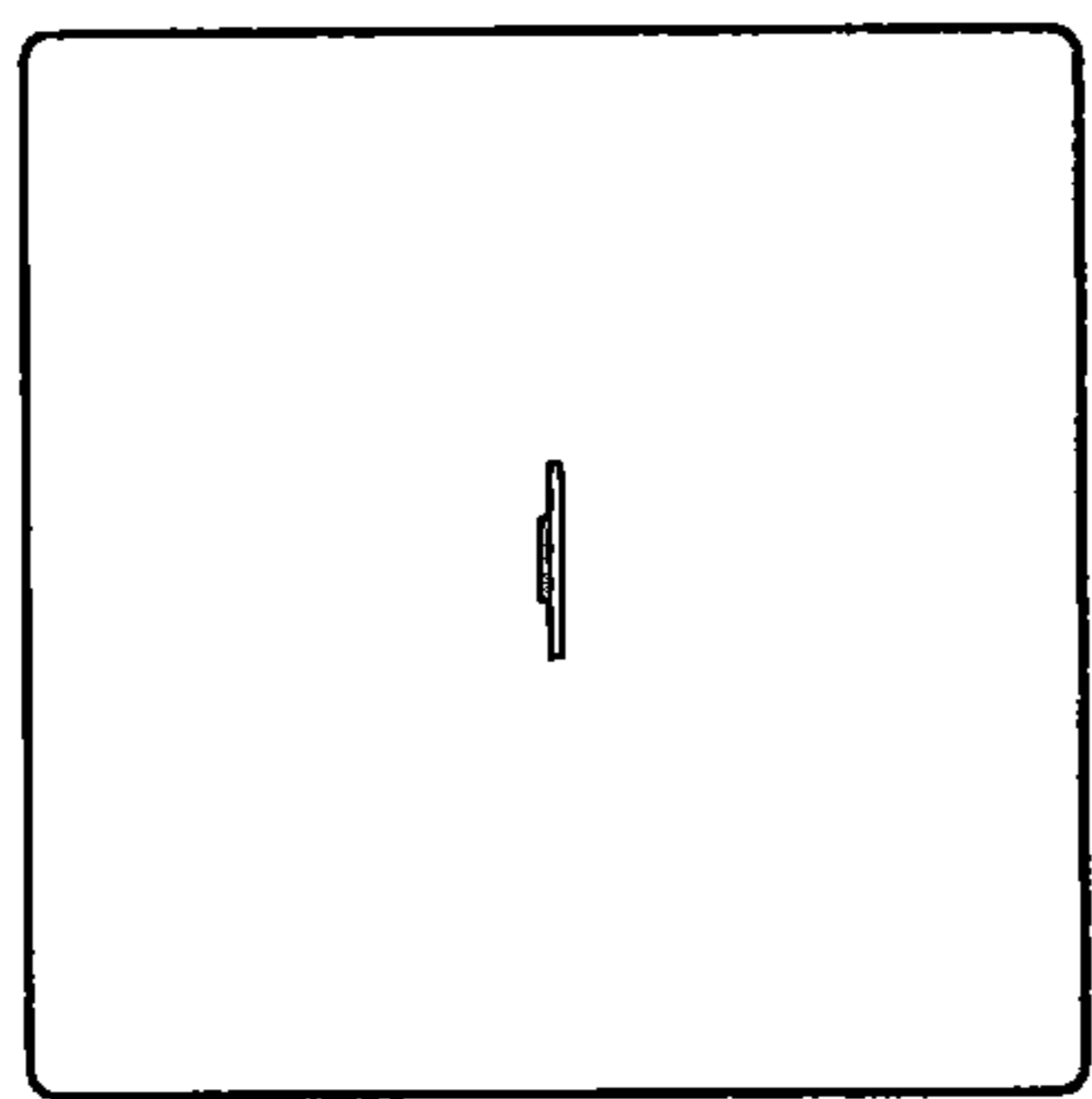

Fig. 157

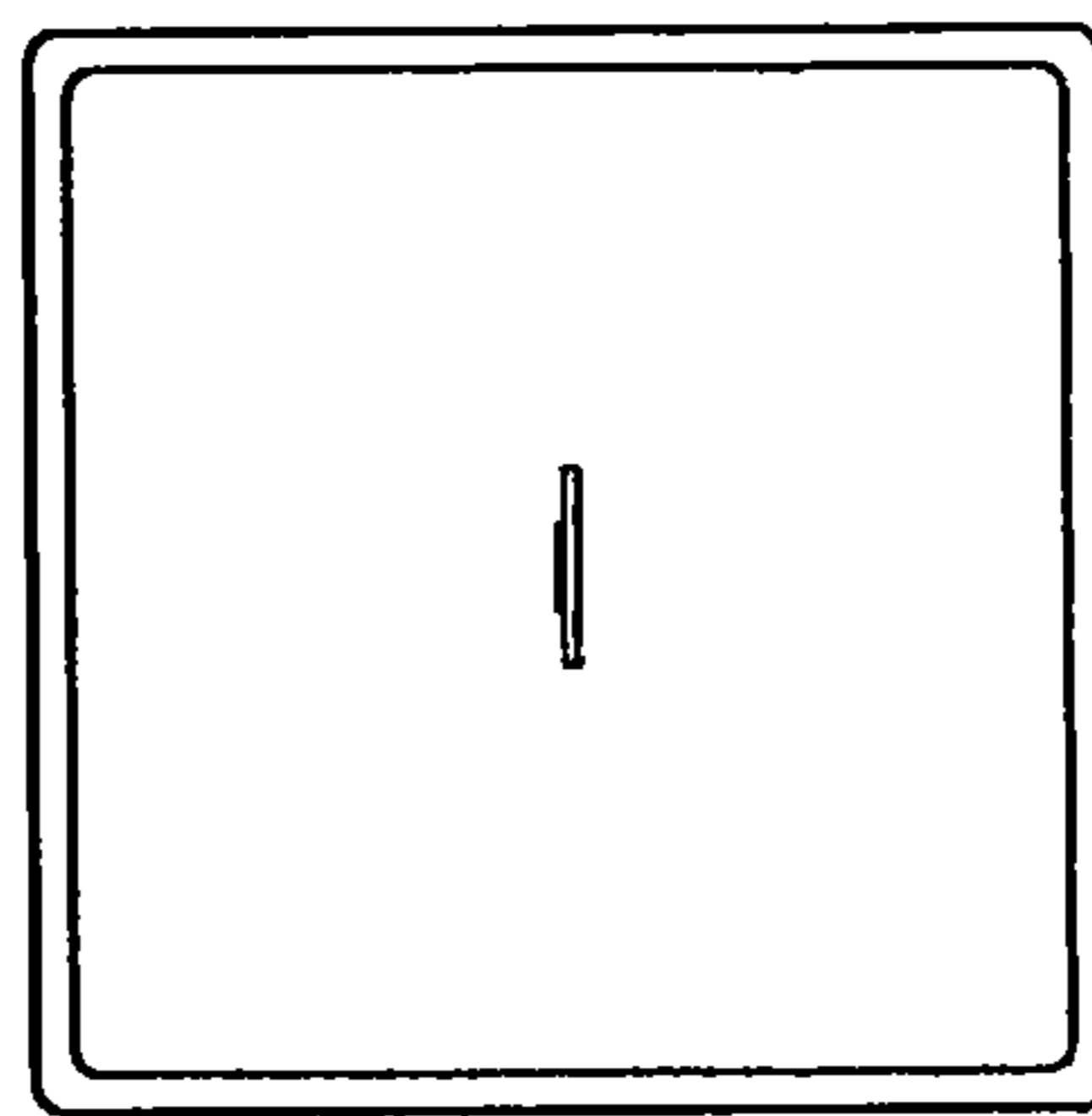

Fig. 160

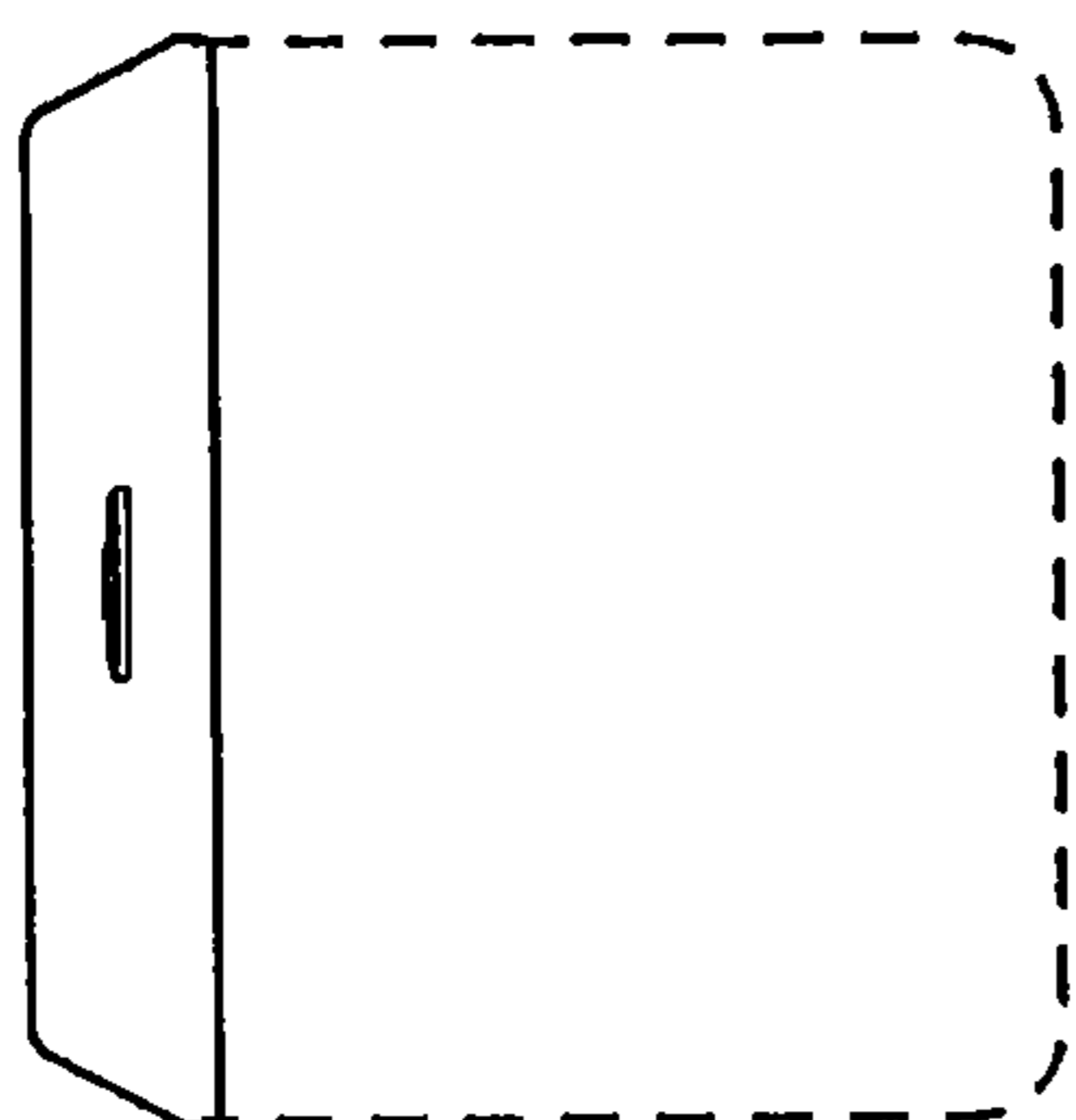

Fig. 156

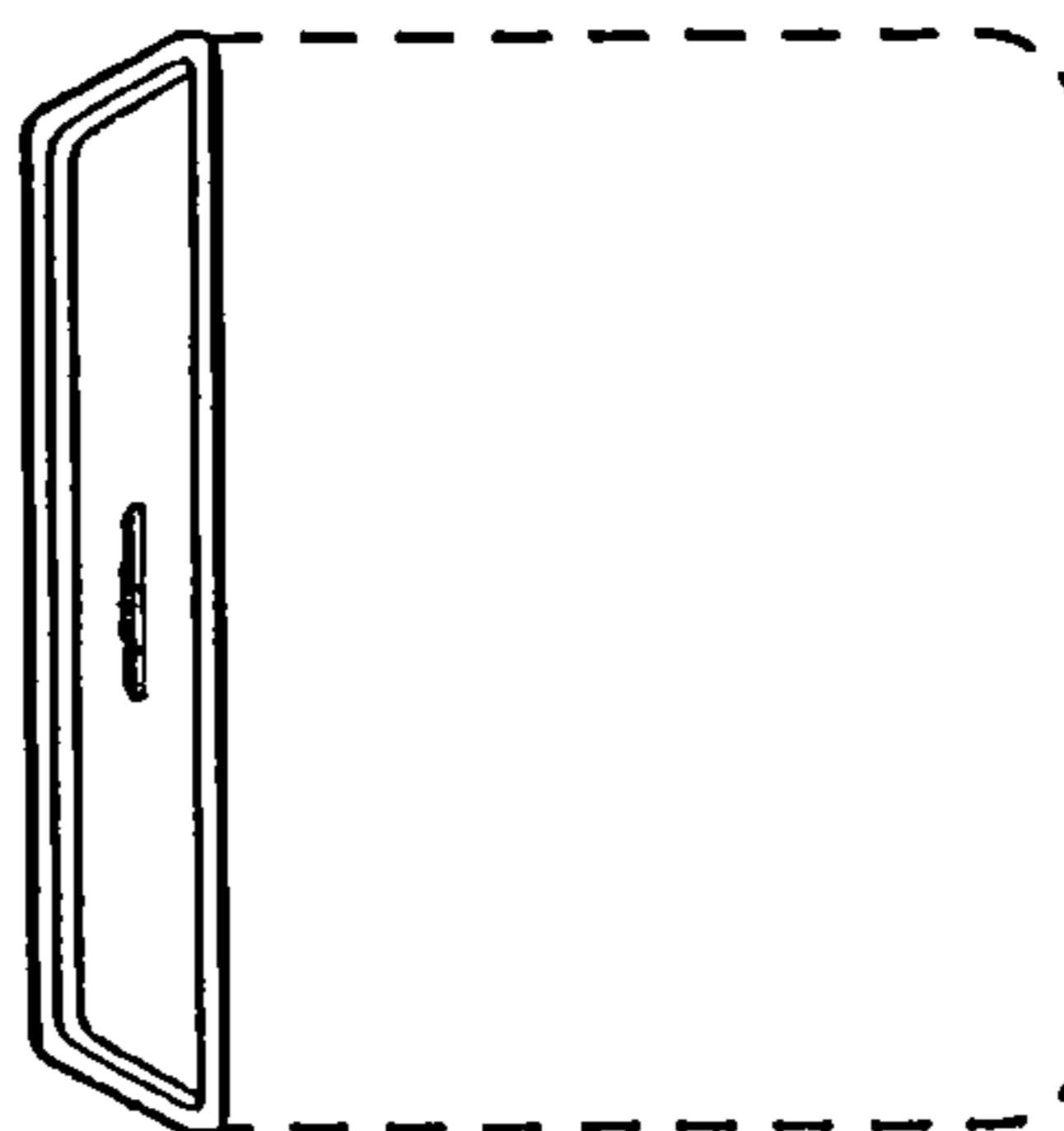

Fig. 159

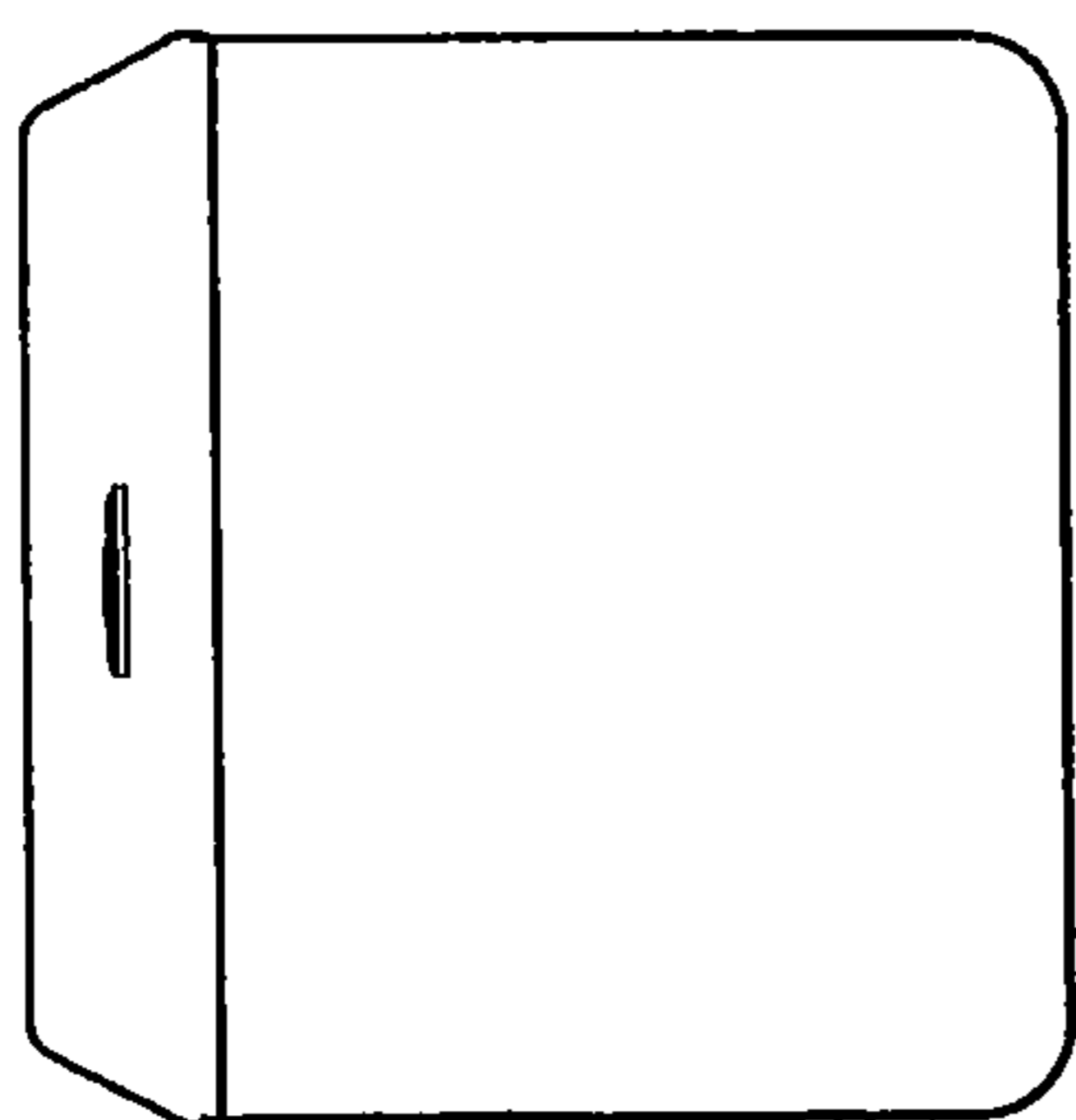

Fig. 155

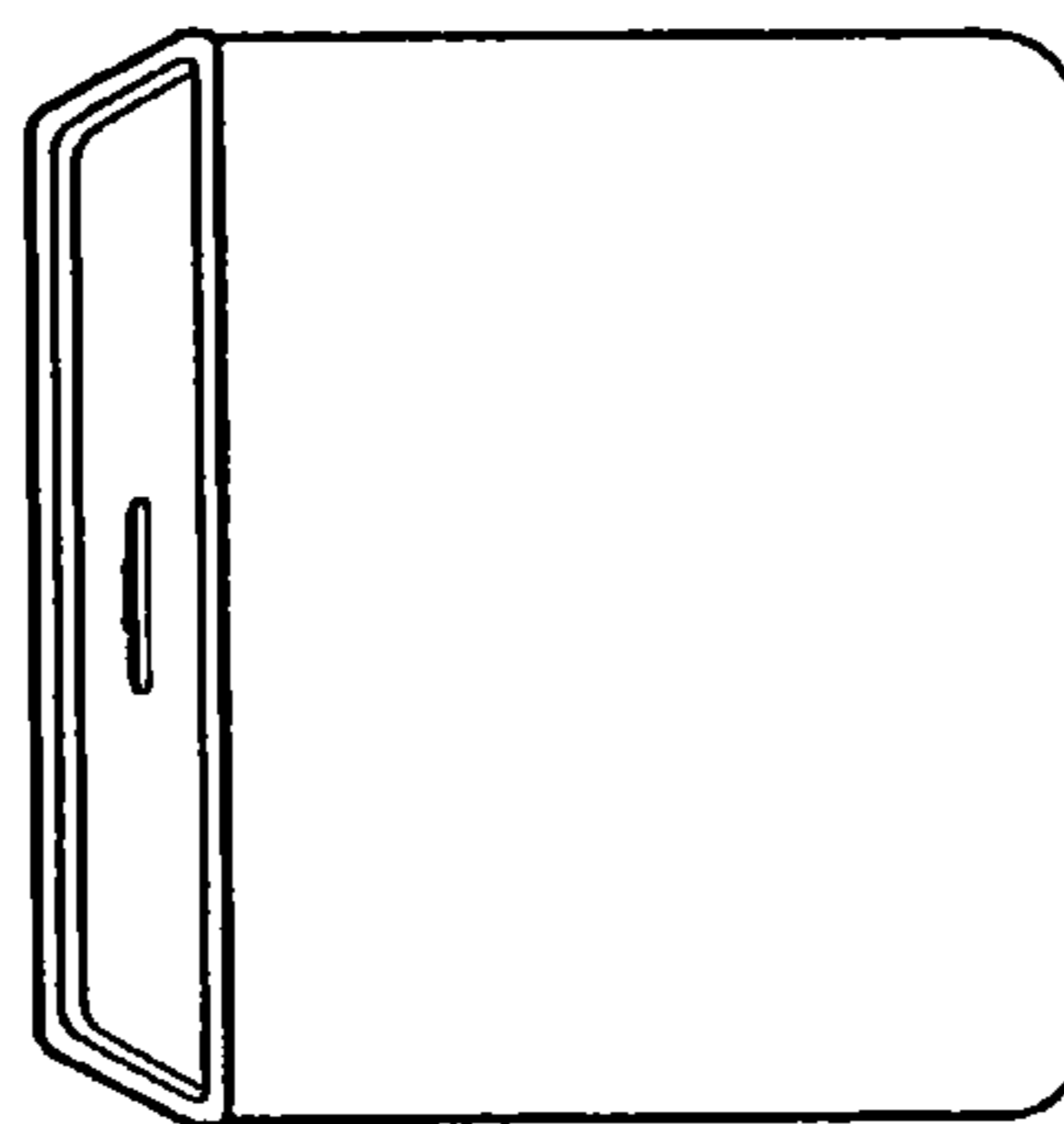

Fig. 158

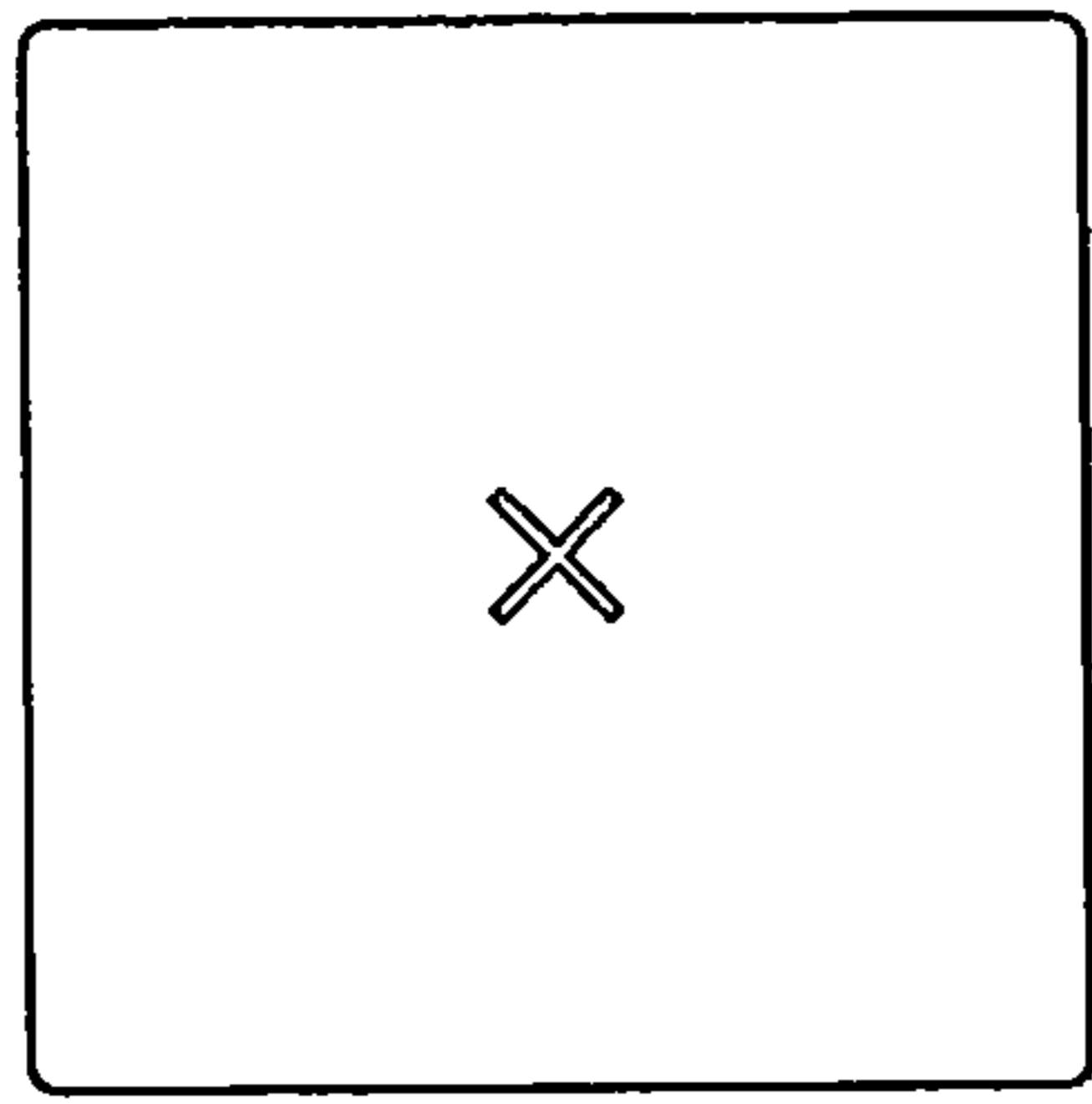

Fig. 163

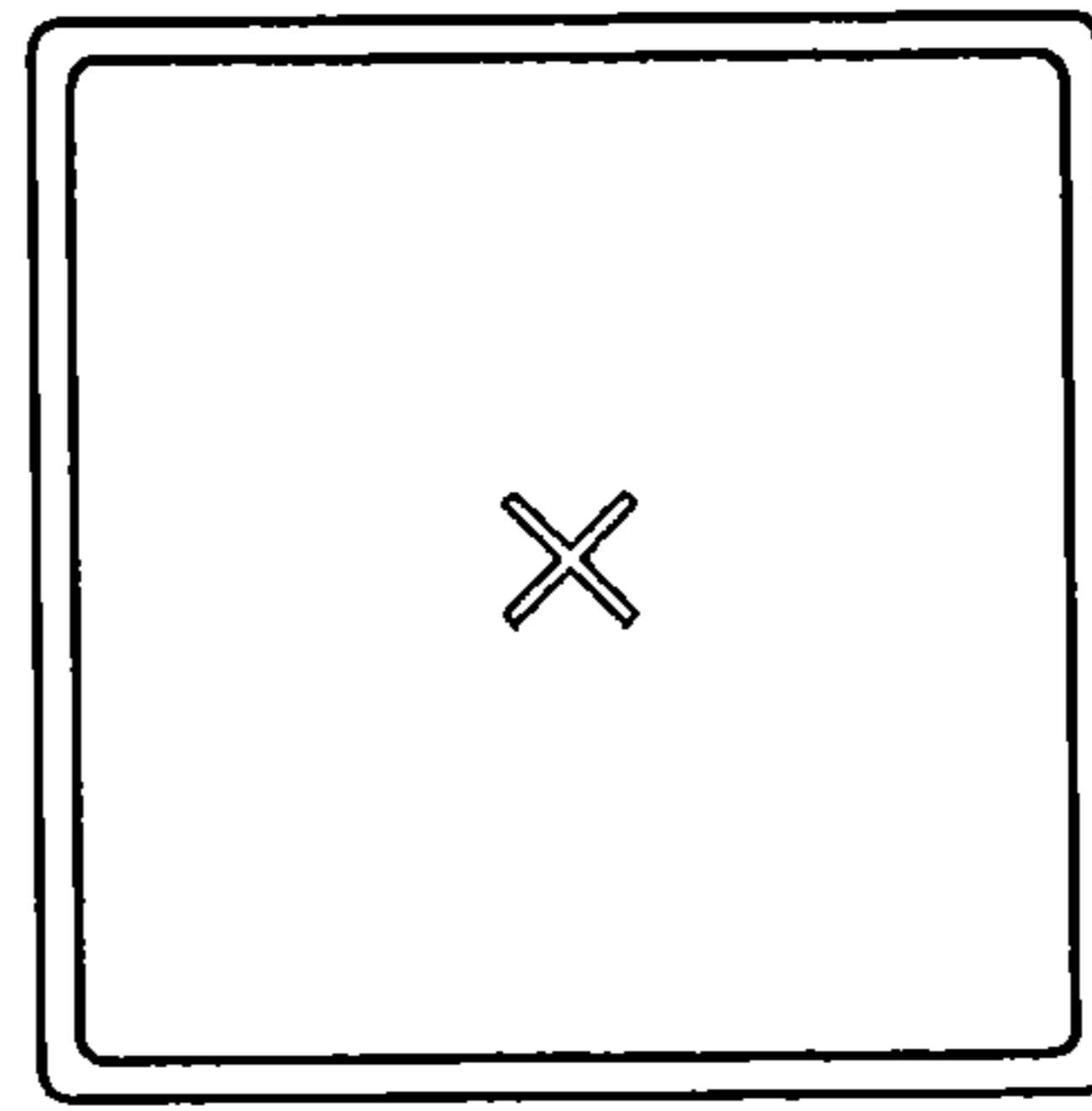

Fig. 166

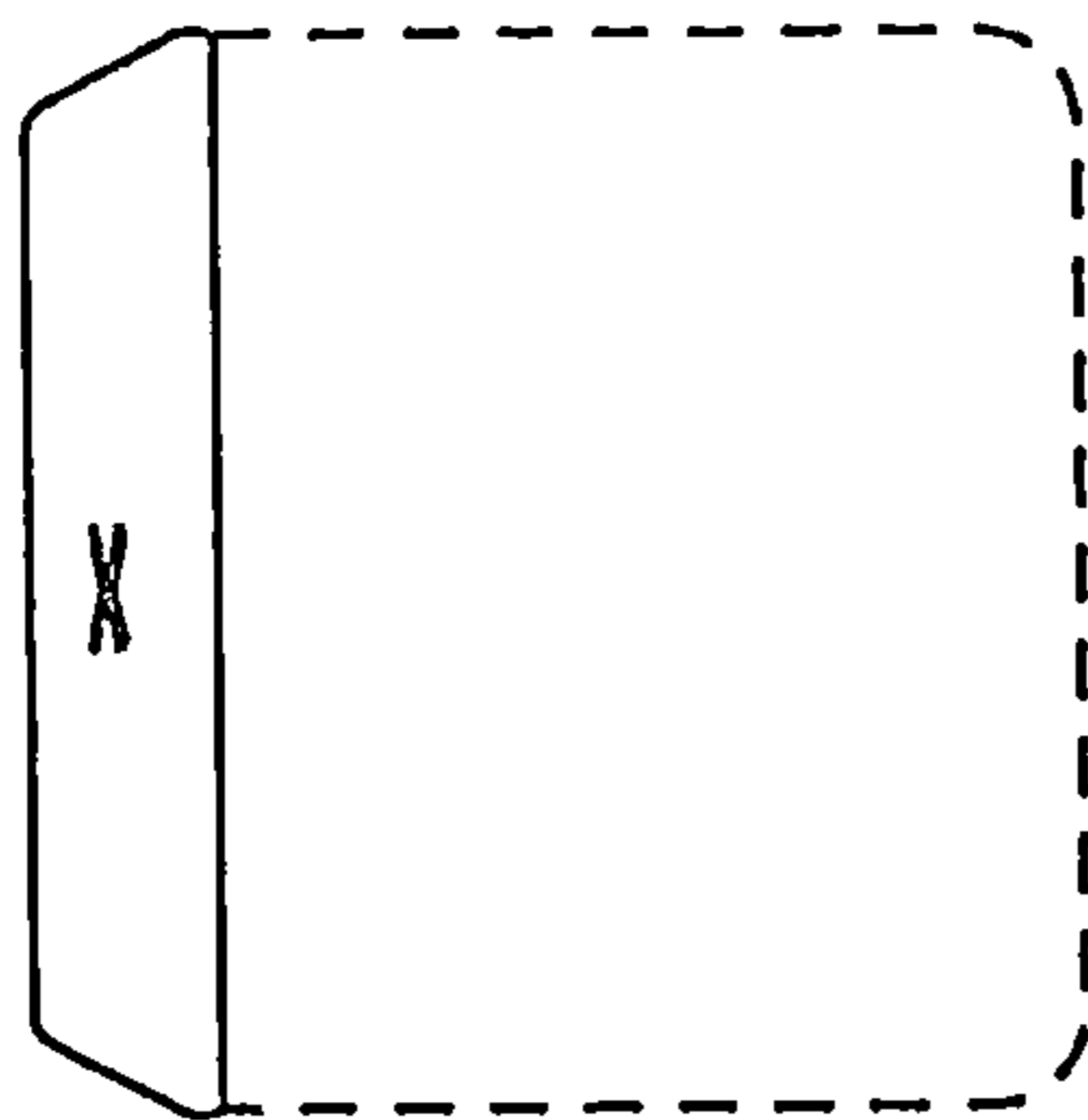

Fig. 162

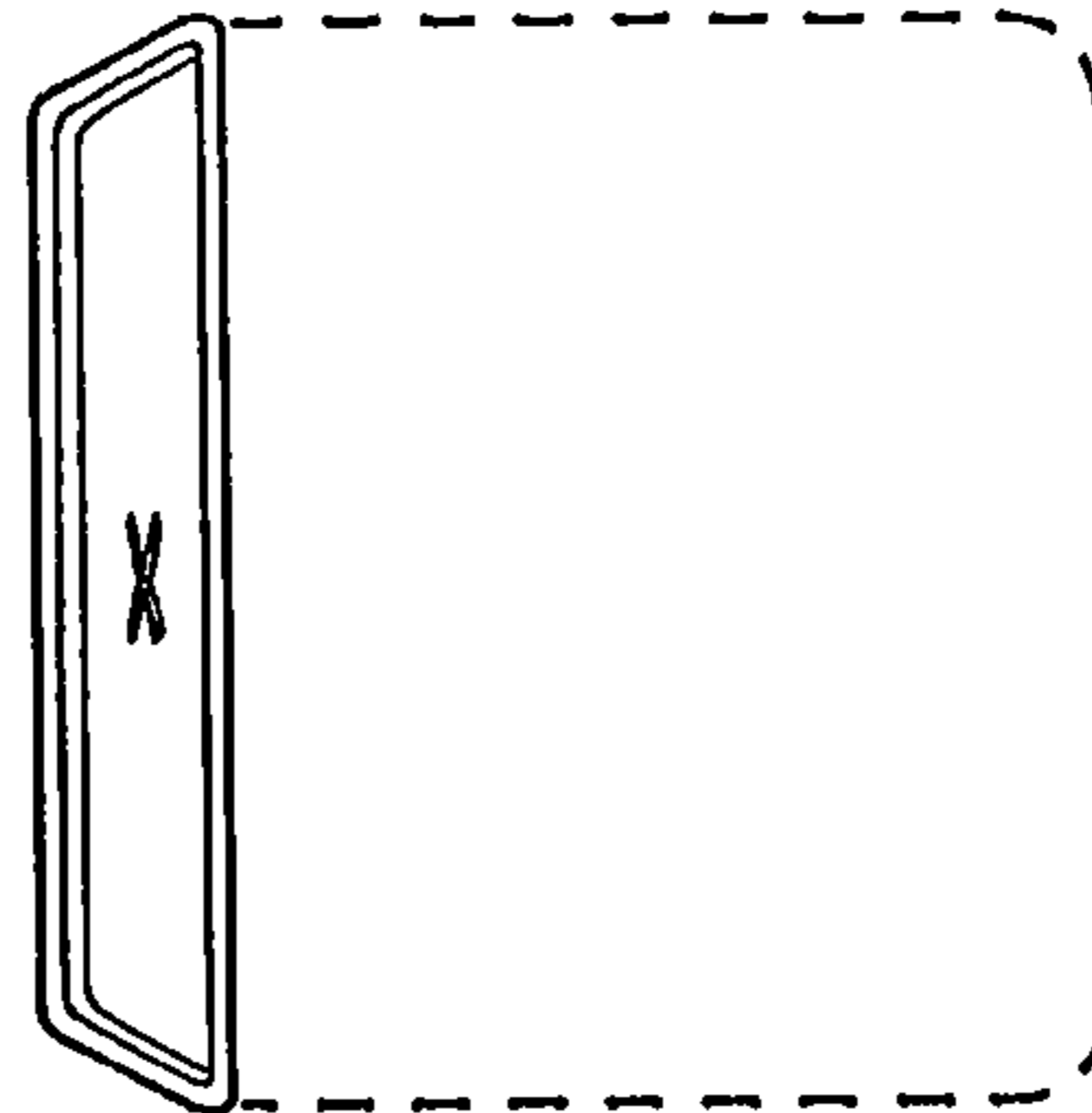

Fig. 165

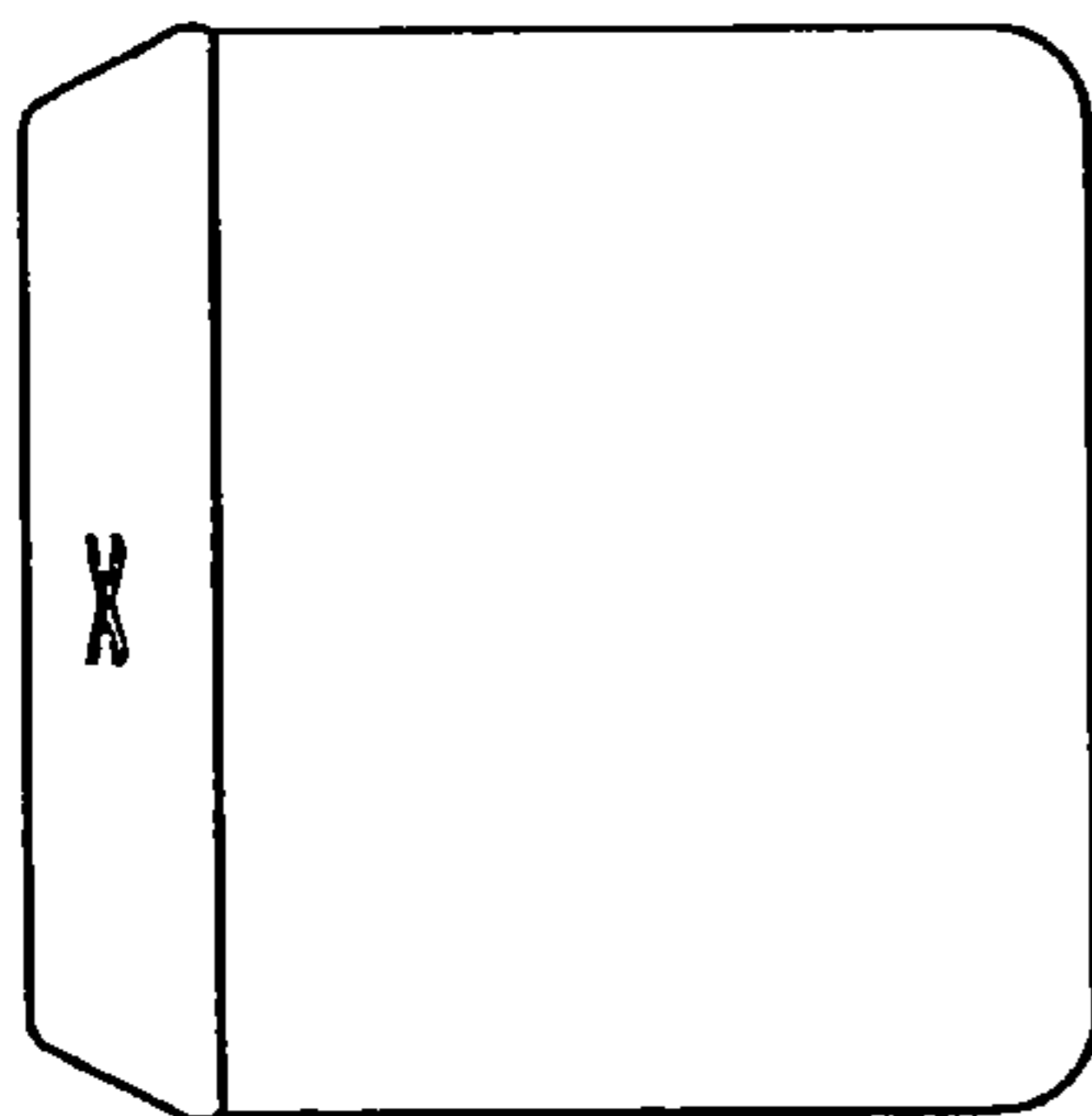

Fig. 161

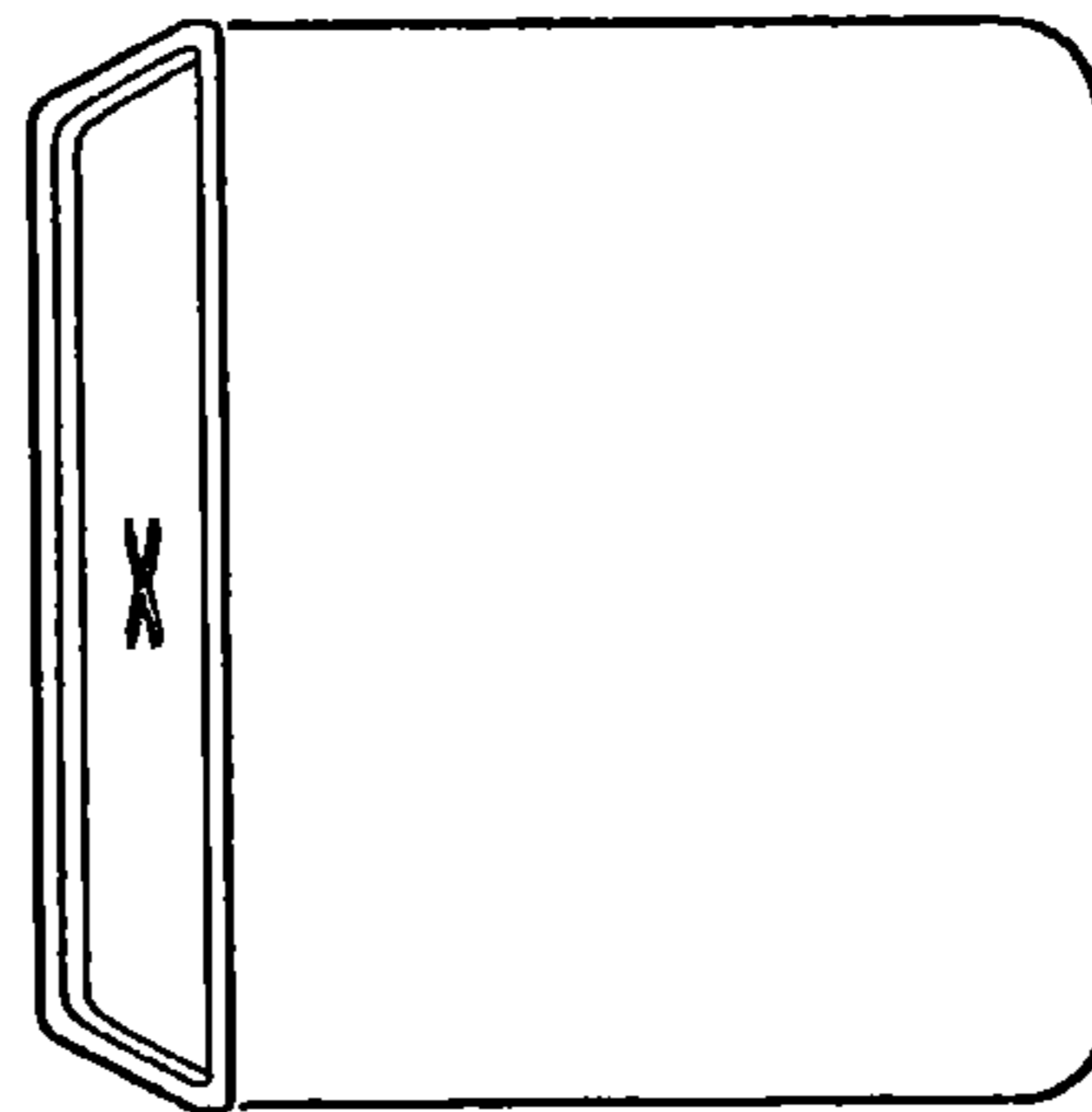

Fig. 164

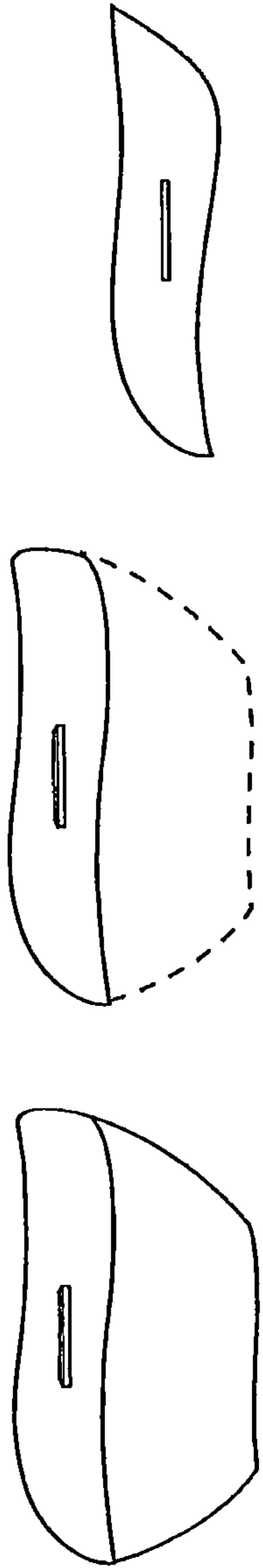

Fig. 169

Fig. 168

Fig. 167

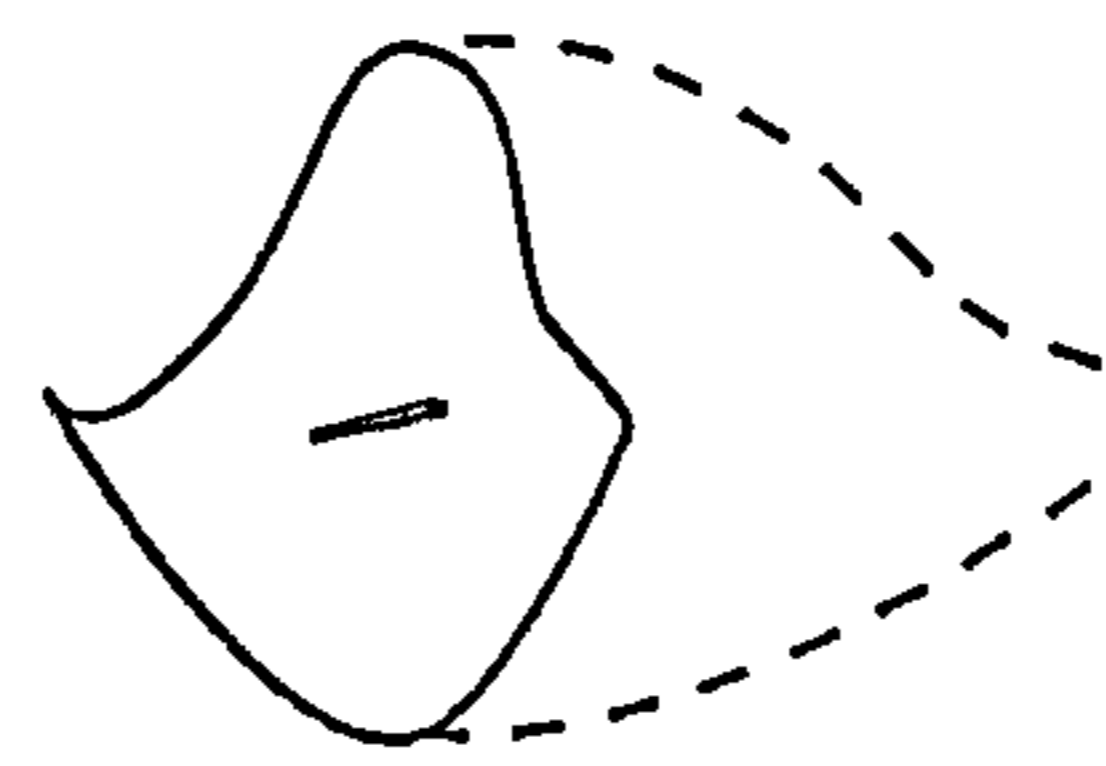

Fig. 171

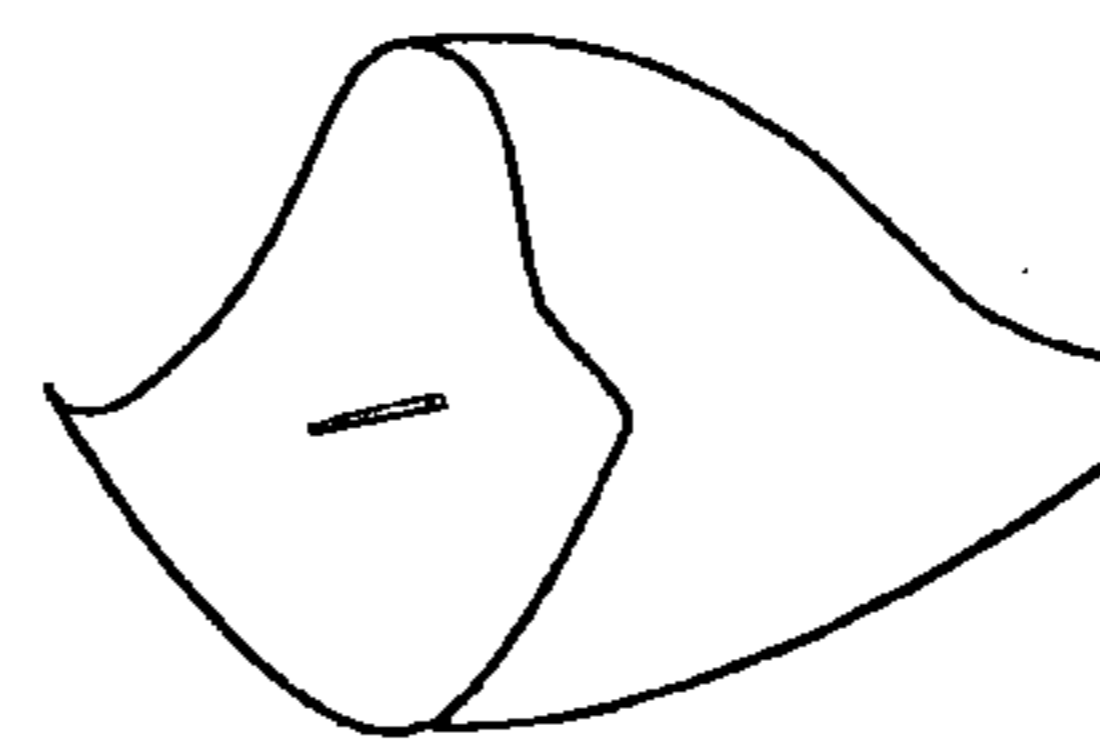

Fig. 170

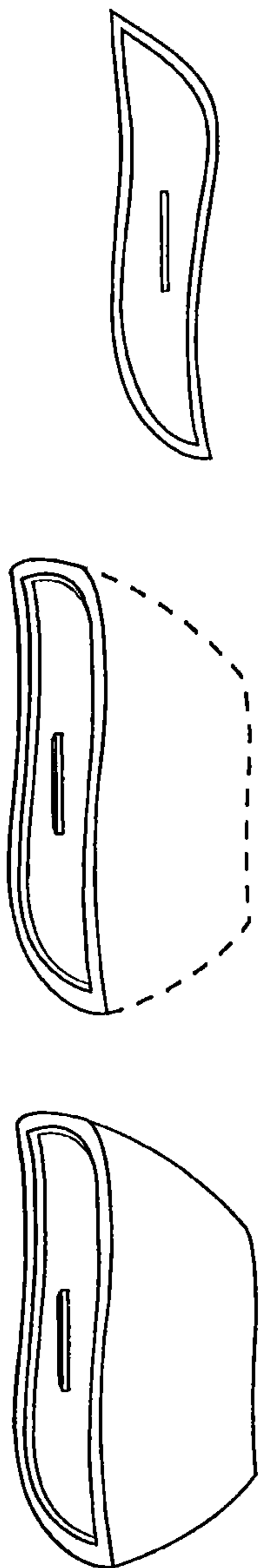

Fig. 174

Fig. 173

Fig. 172

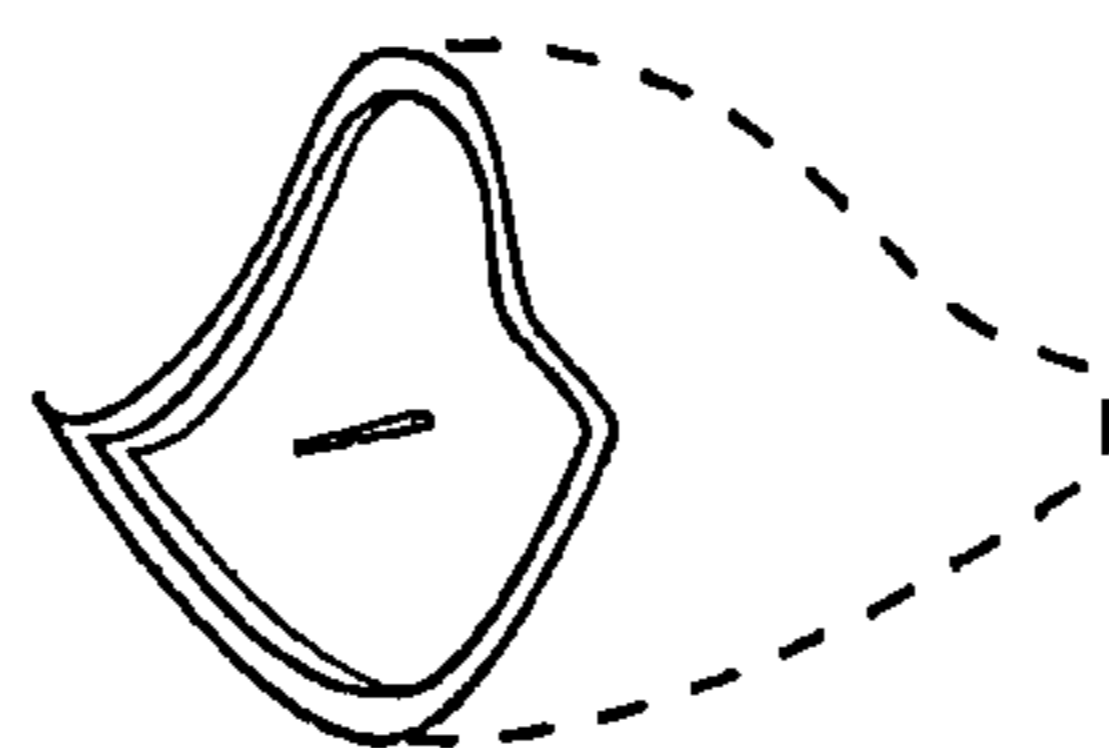

Fig. 176

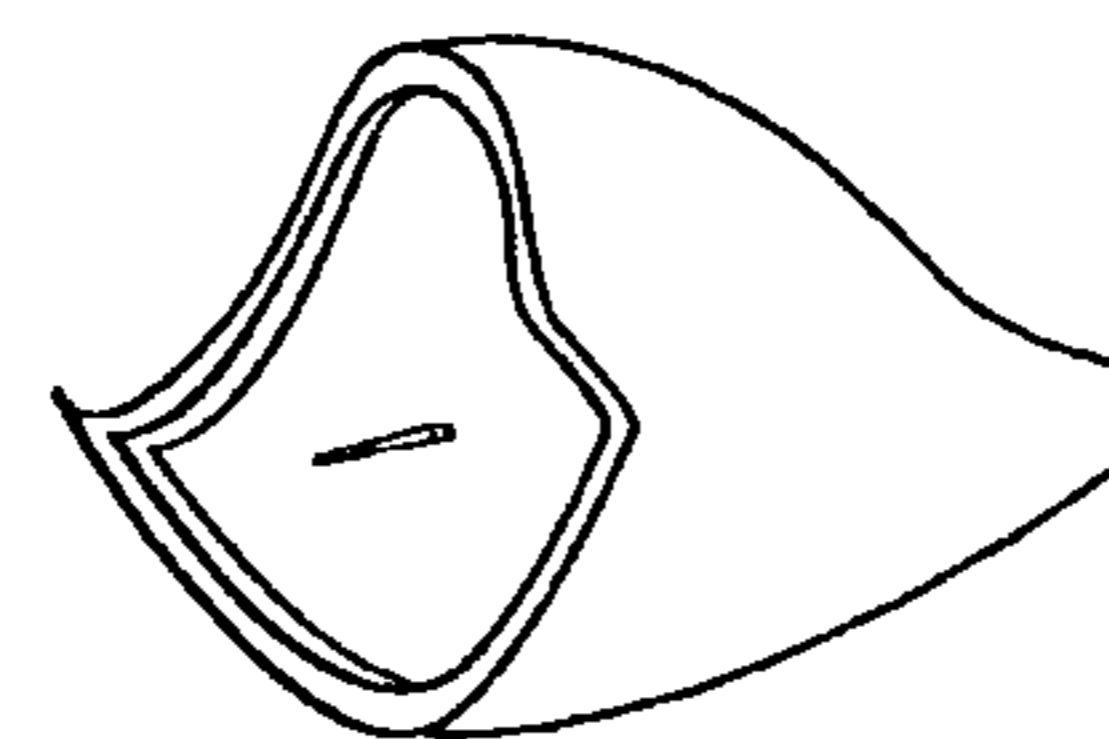

Fig. 175

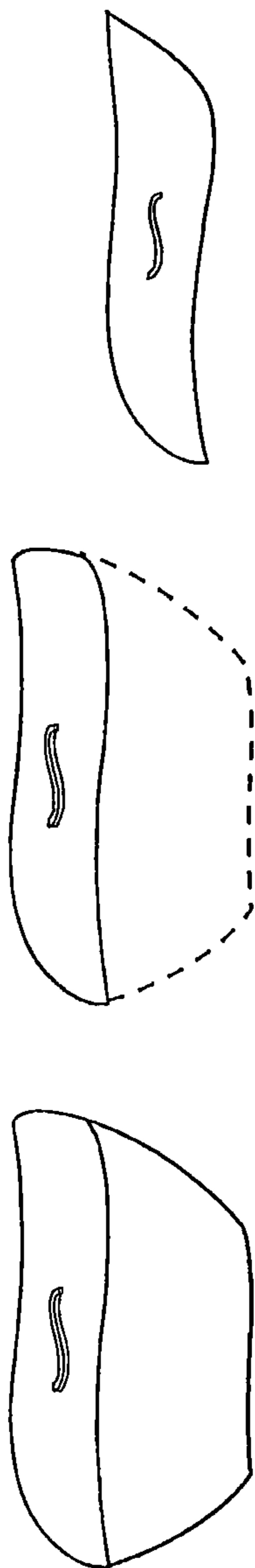

Fig. 179

Fig. 178

Fig. 177

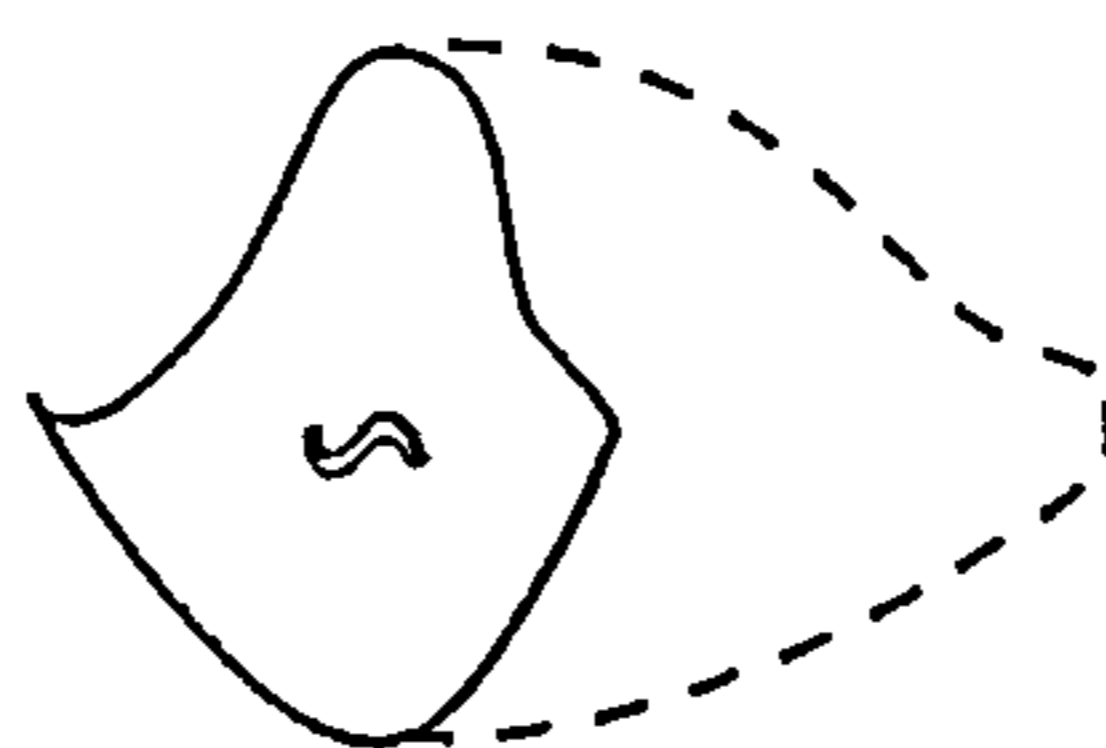

Fig. 181

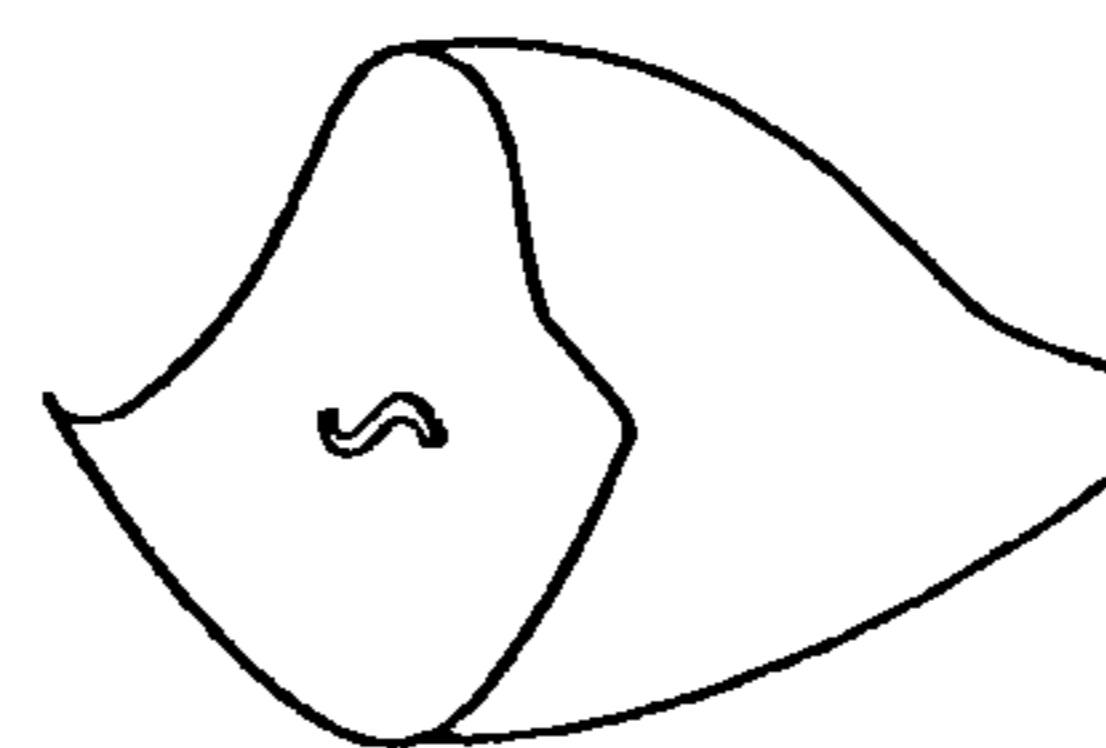

Fig. 180

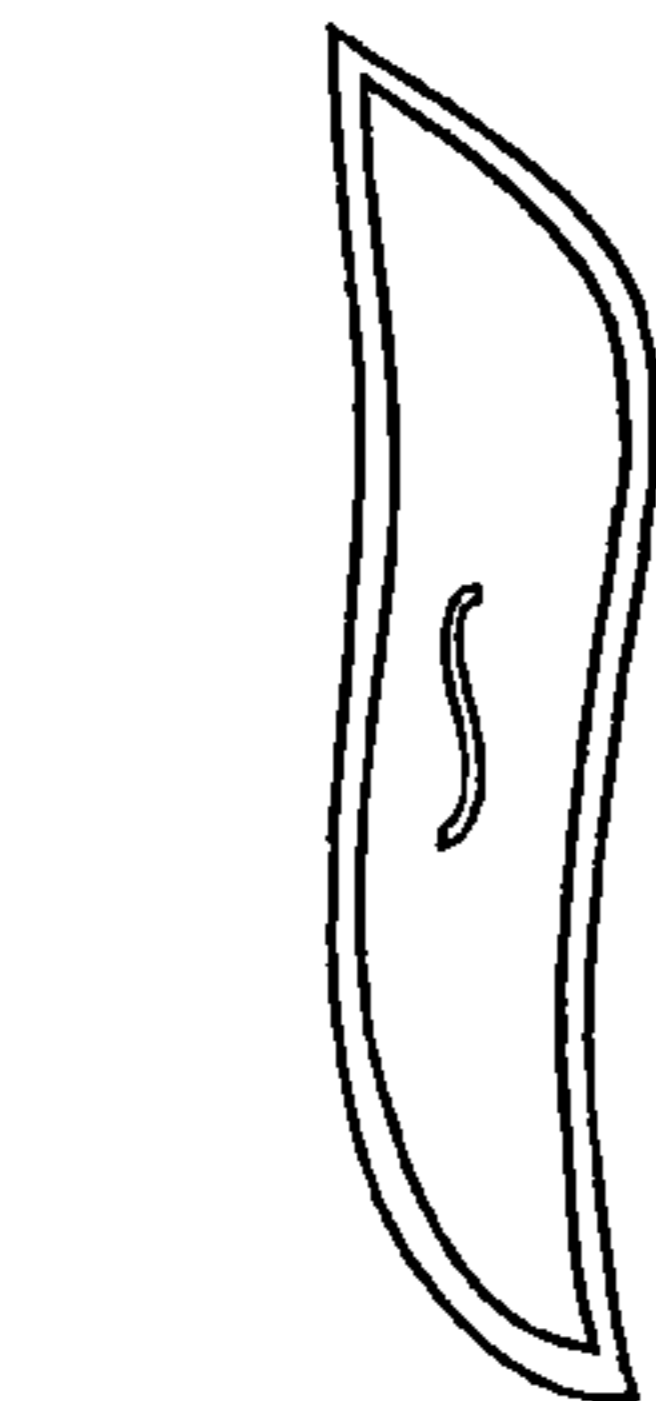

Fig. 182

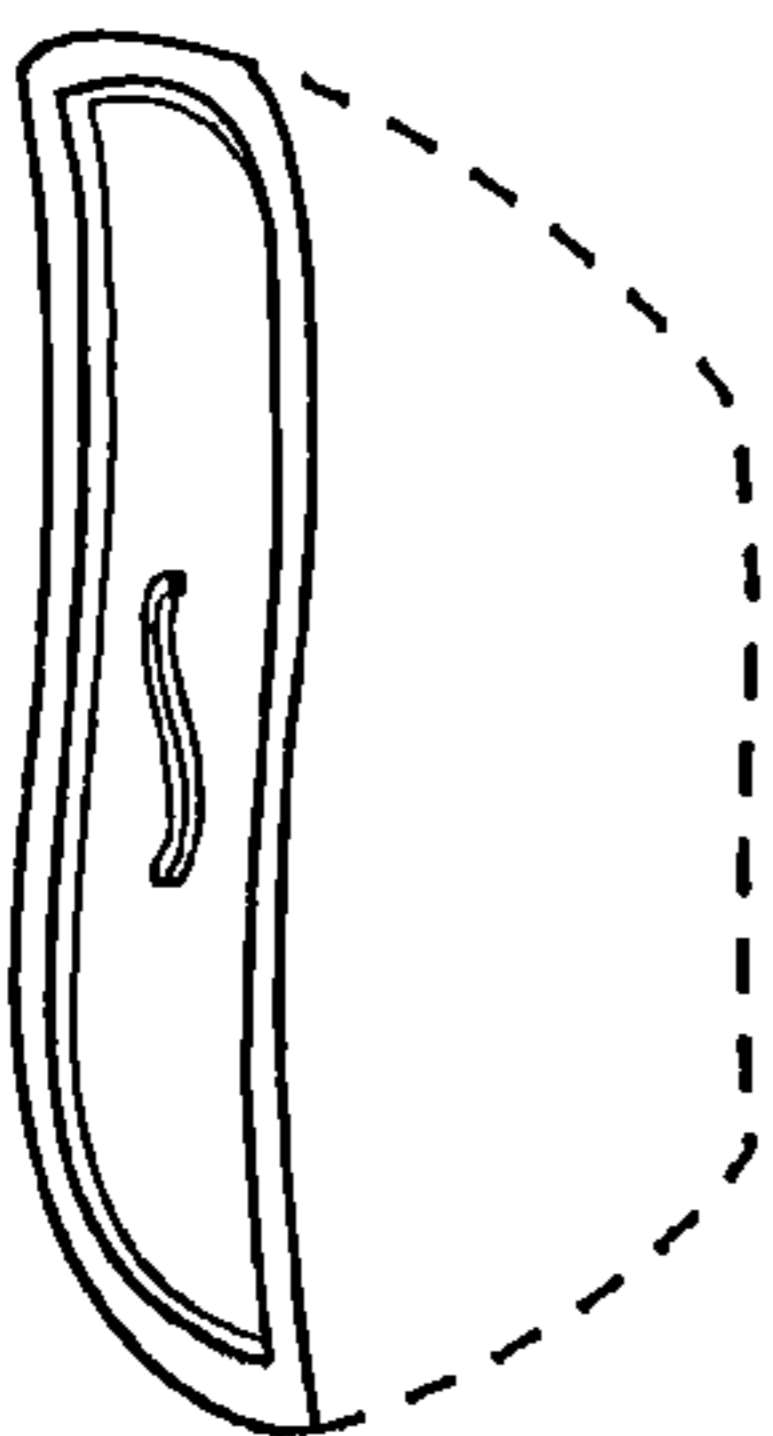

Fig. 183

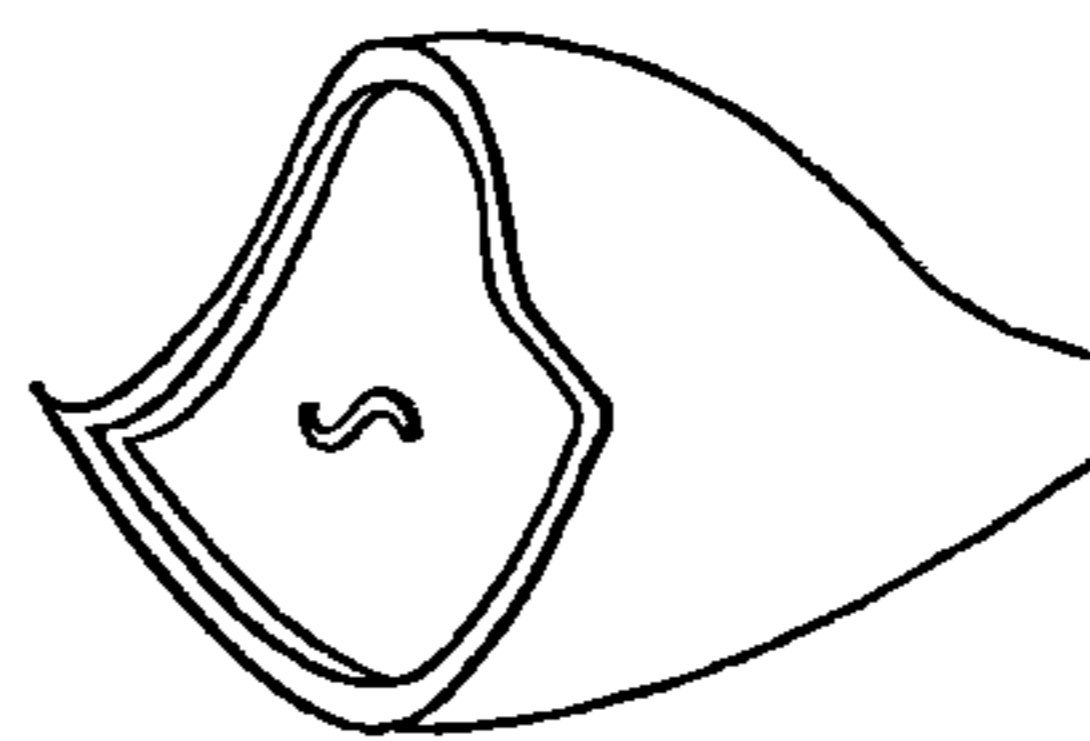

Fig. 184

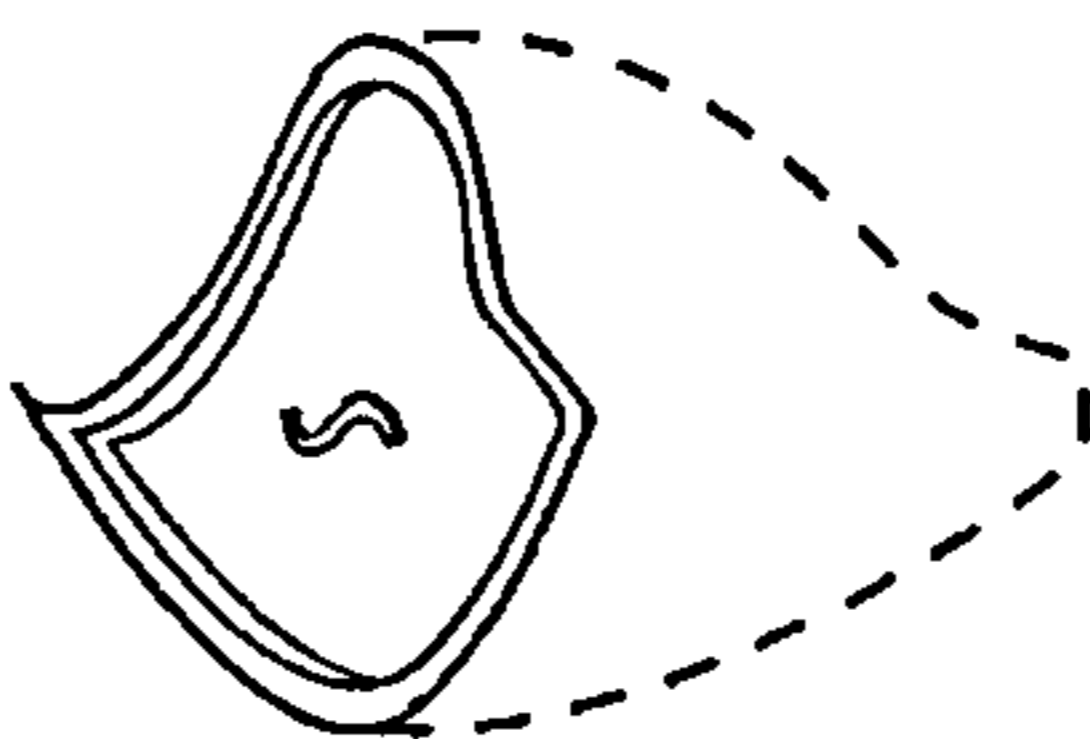

Fig. 185

Fig. 186

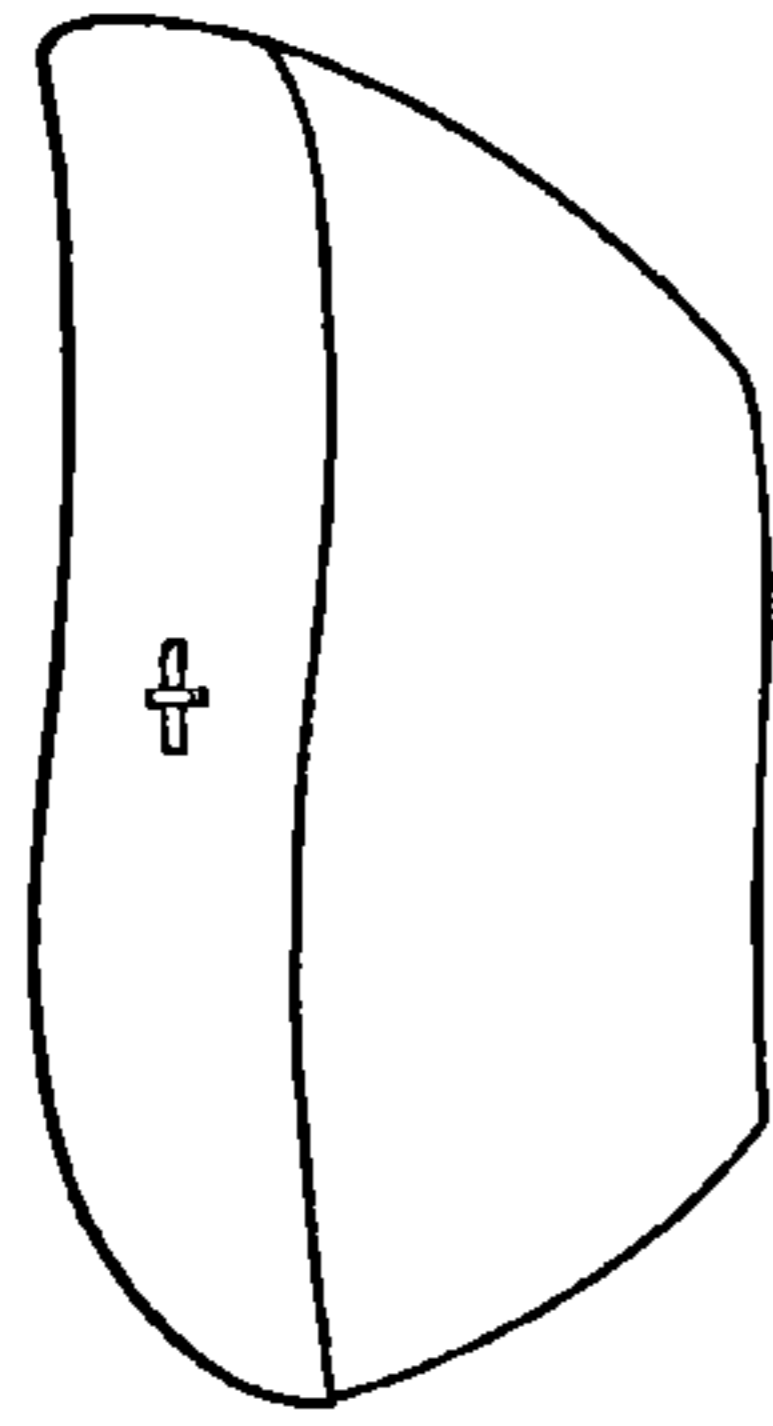

Fig. 187

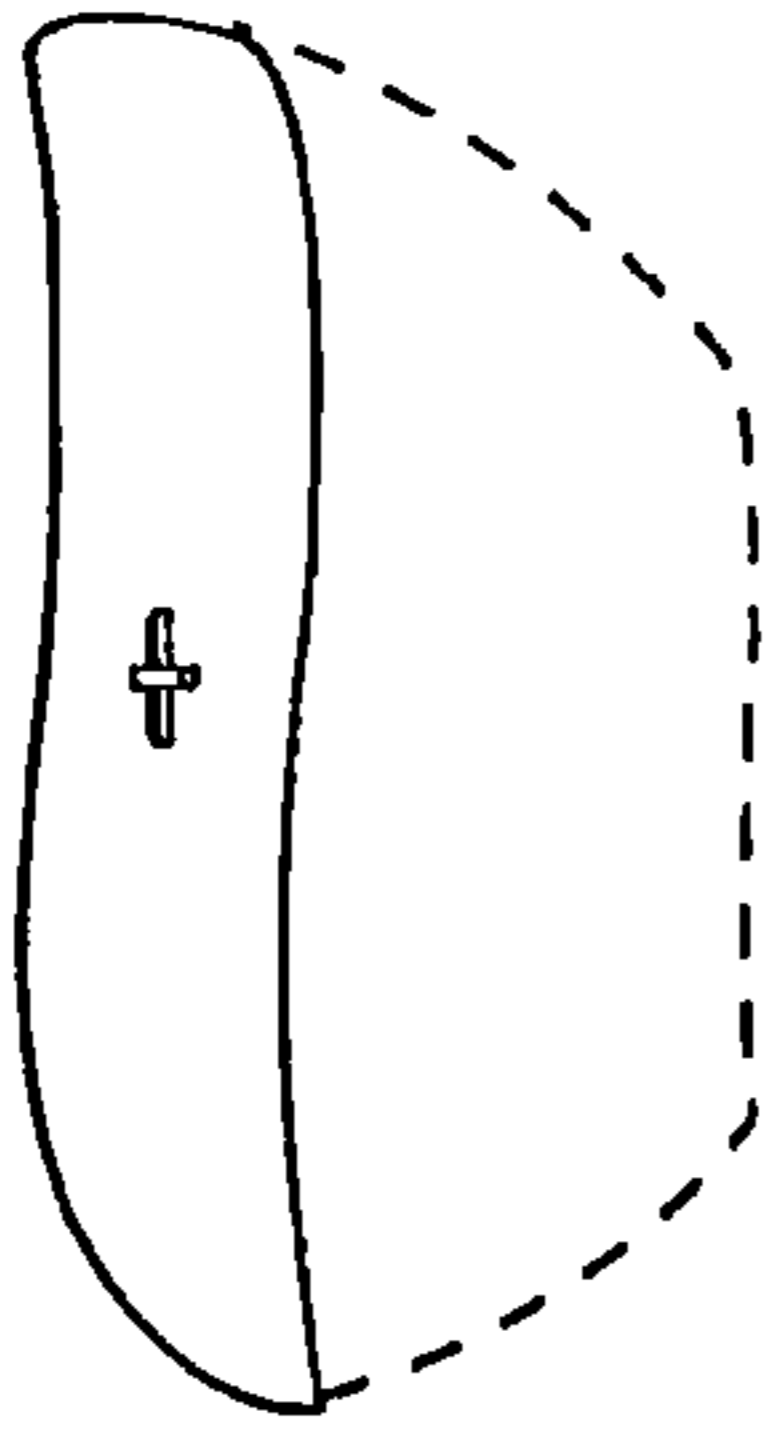

Fig. 188

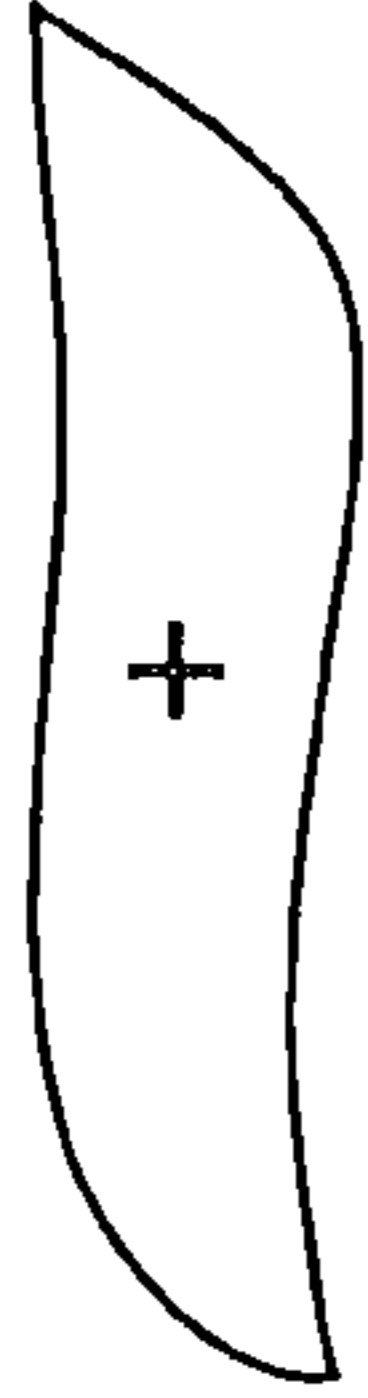

Fig. 189

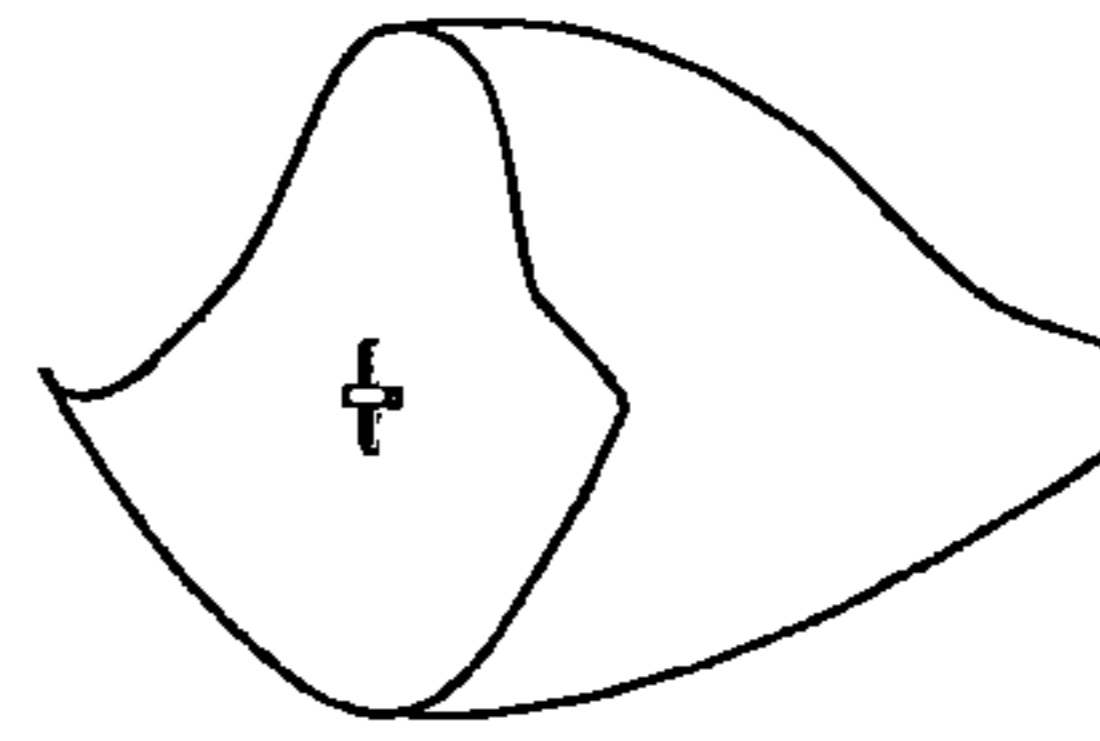

Fig. 190

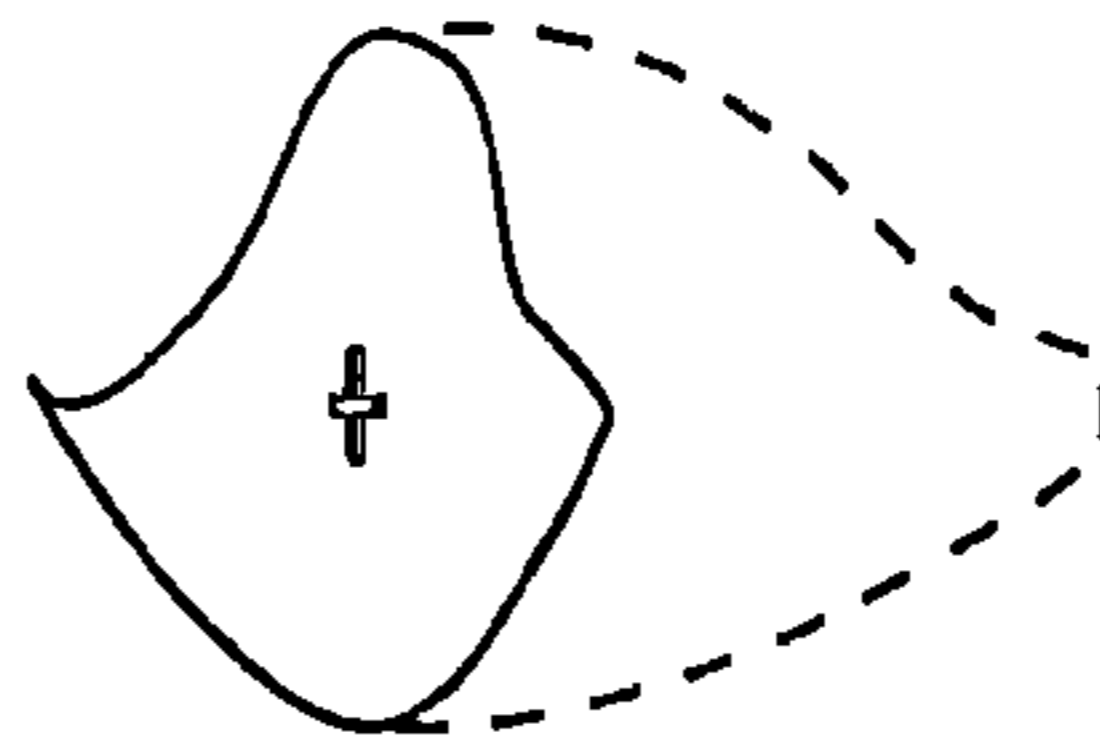

Fig. 191

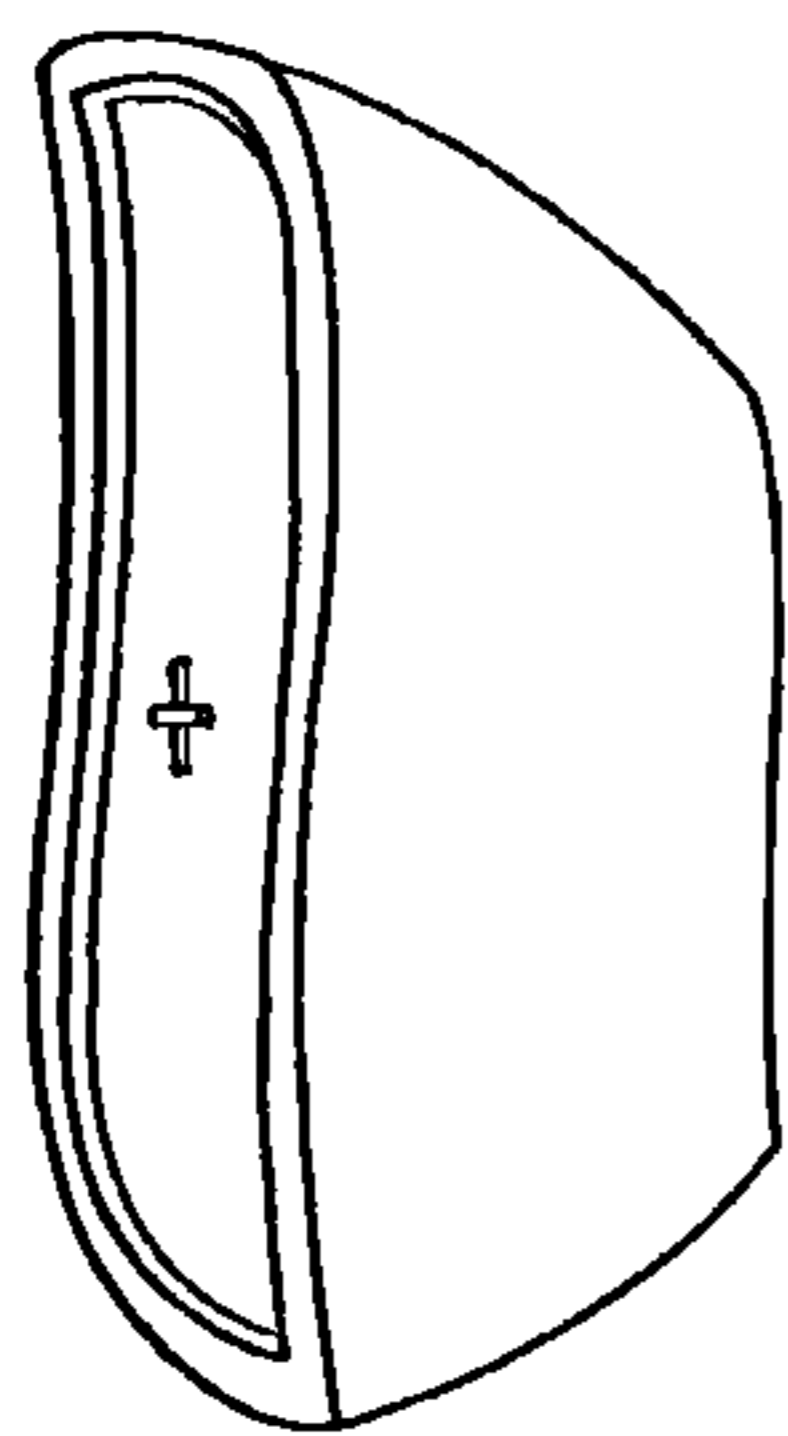

Fig. 192

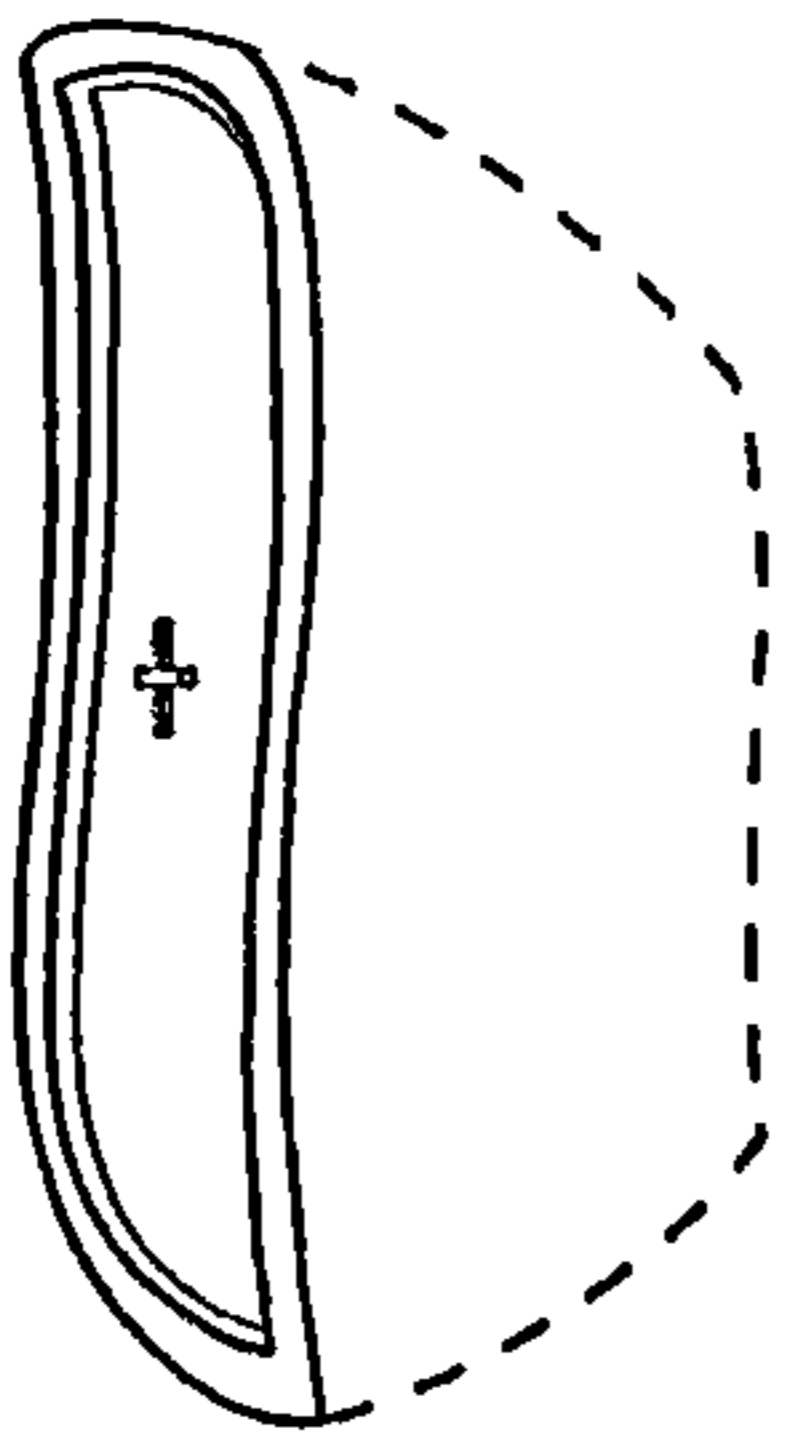

Fig. 193

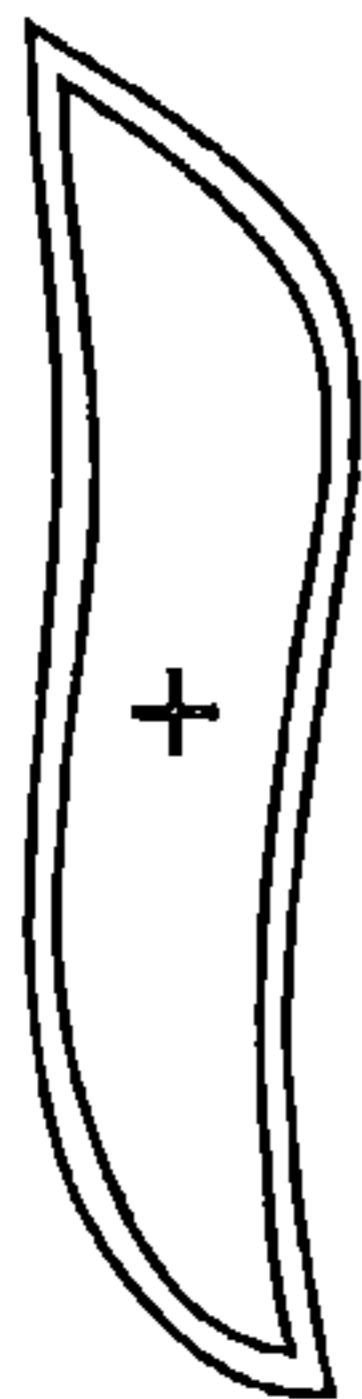

Fig. 194

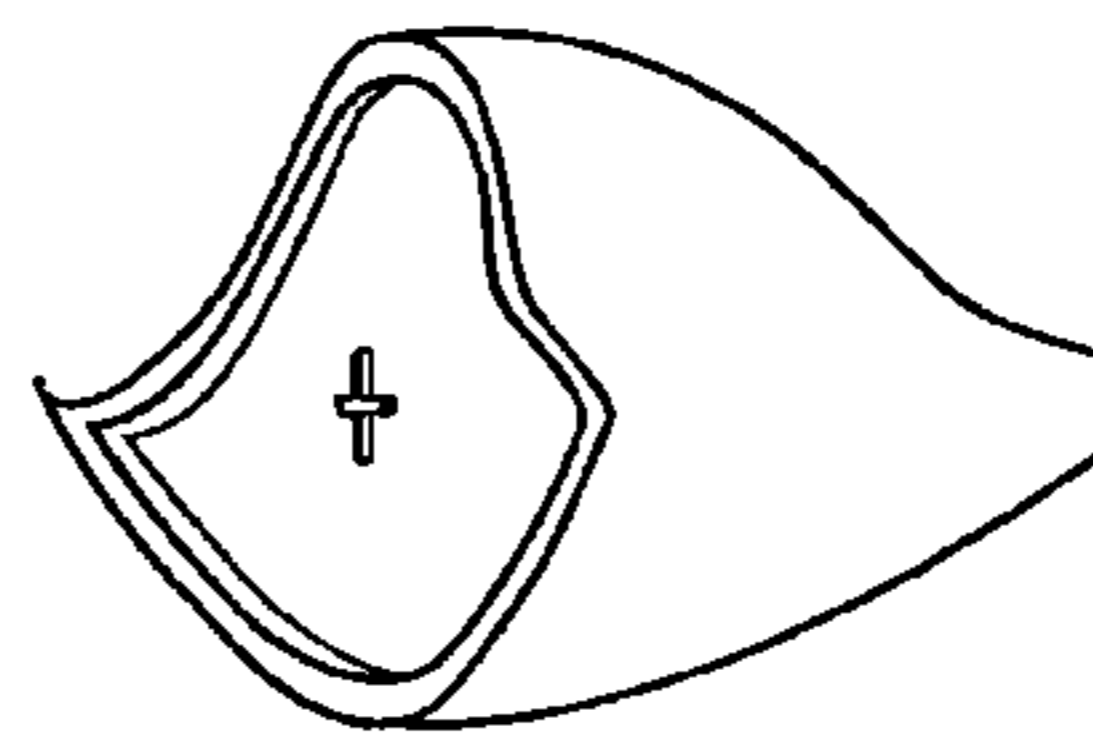

Fig. 195

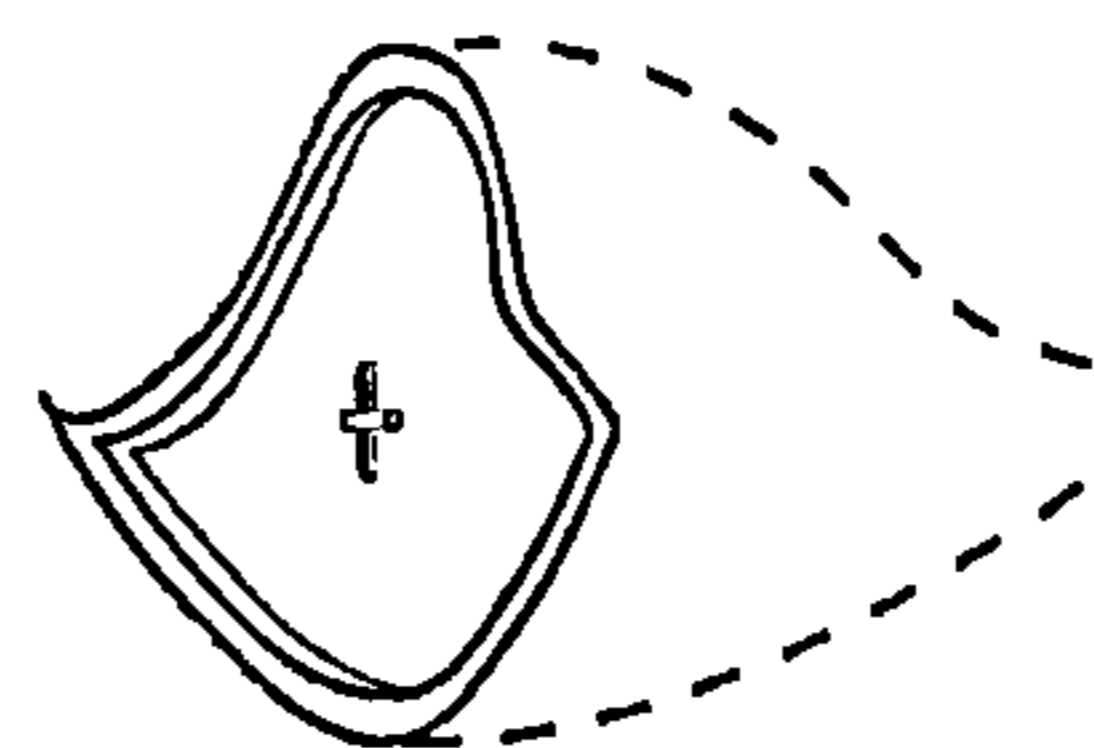

Fig. 196

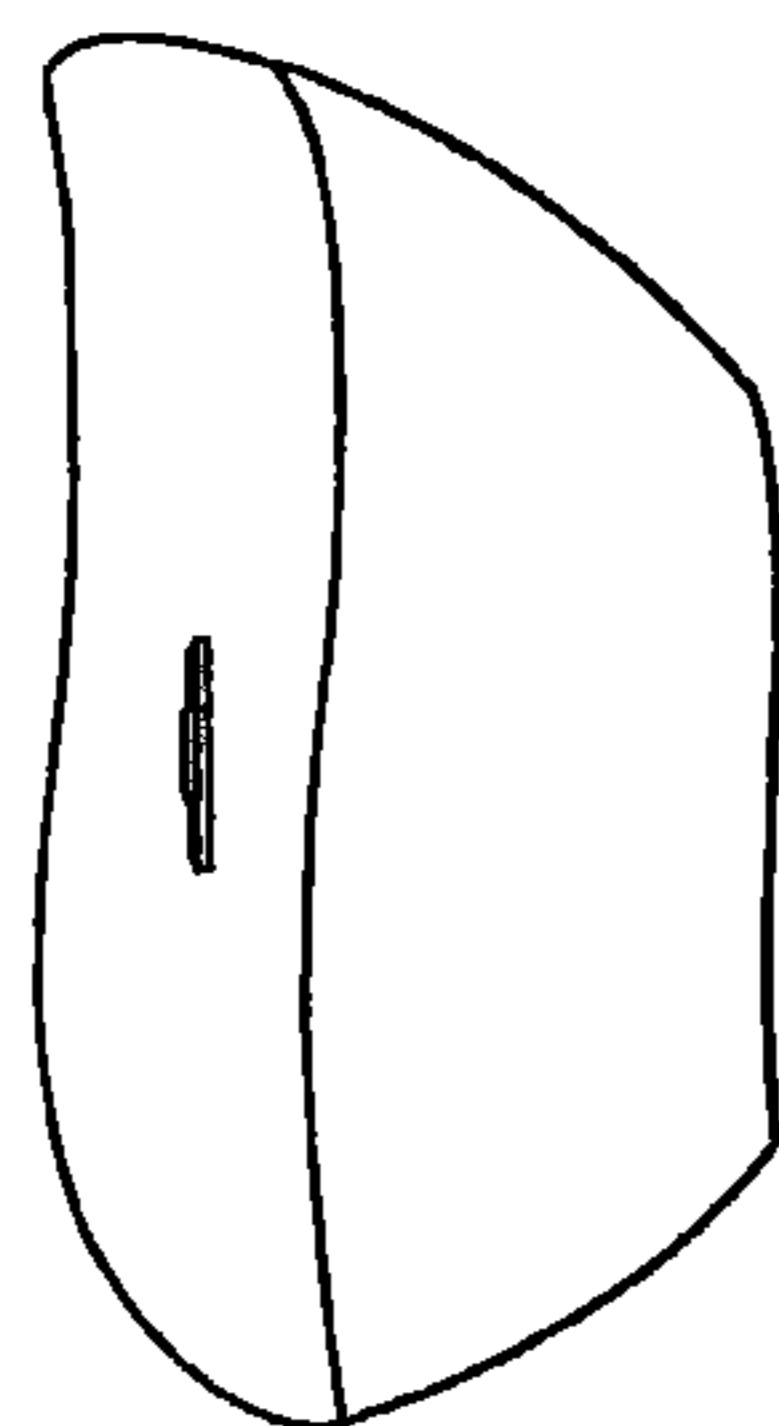

Fig. 197

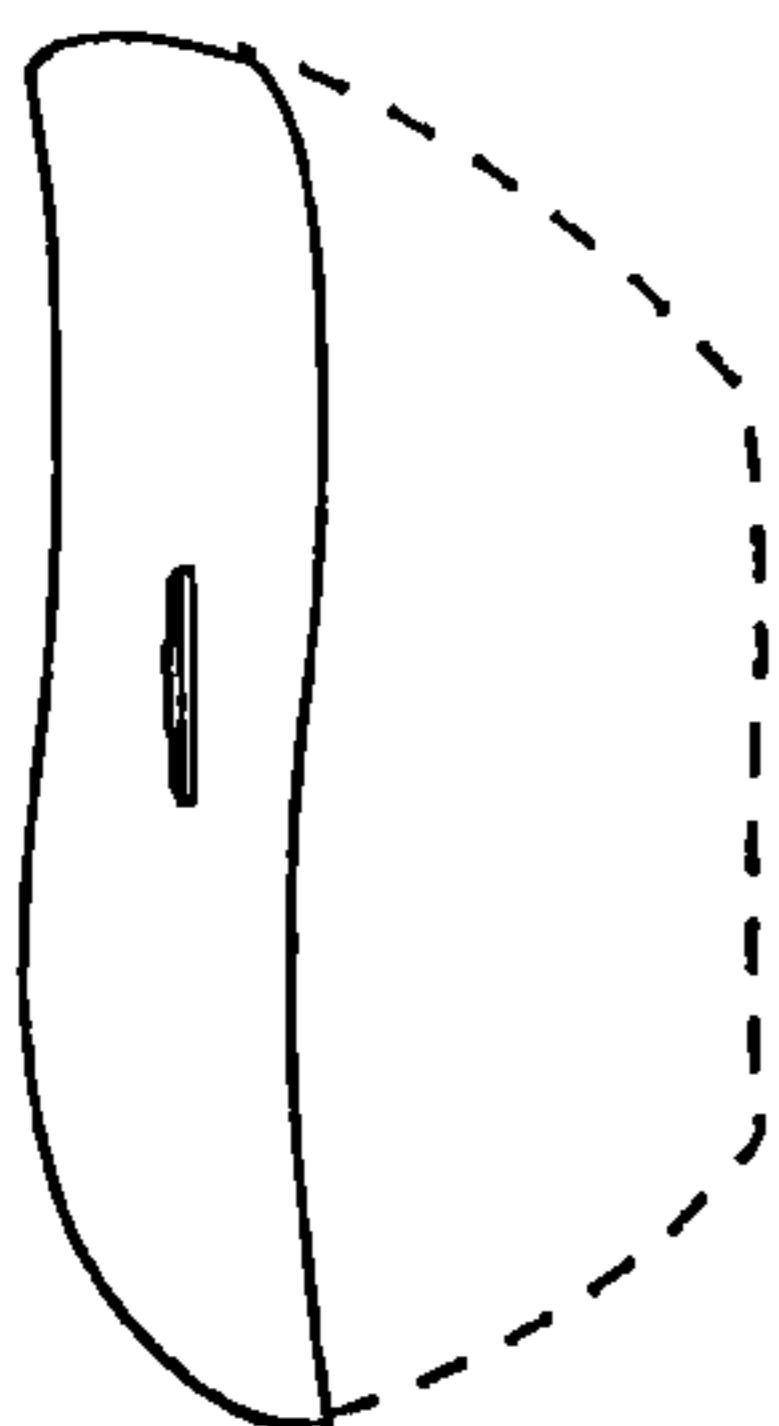

Fig. 198

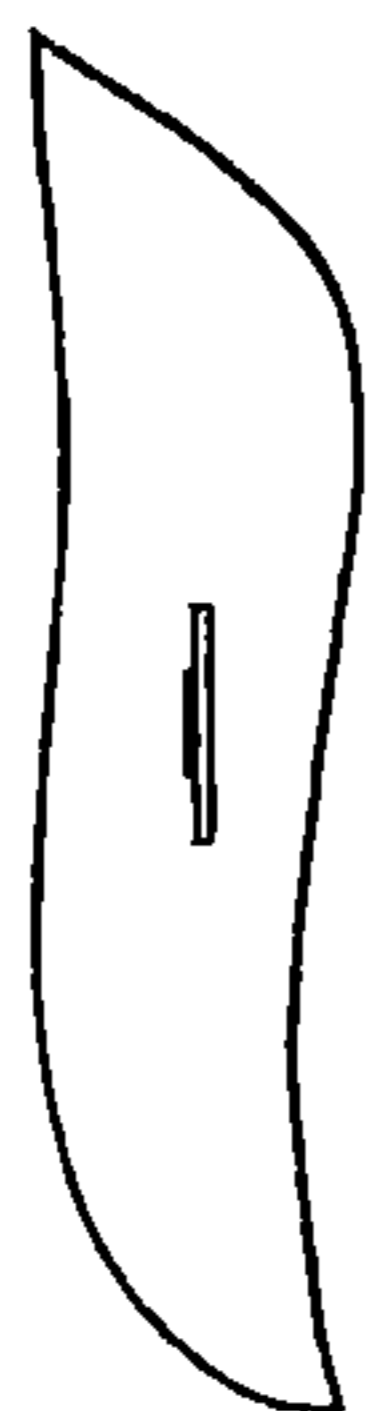

Fig. 199

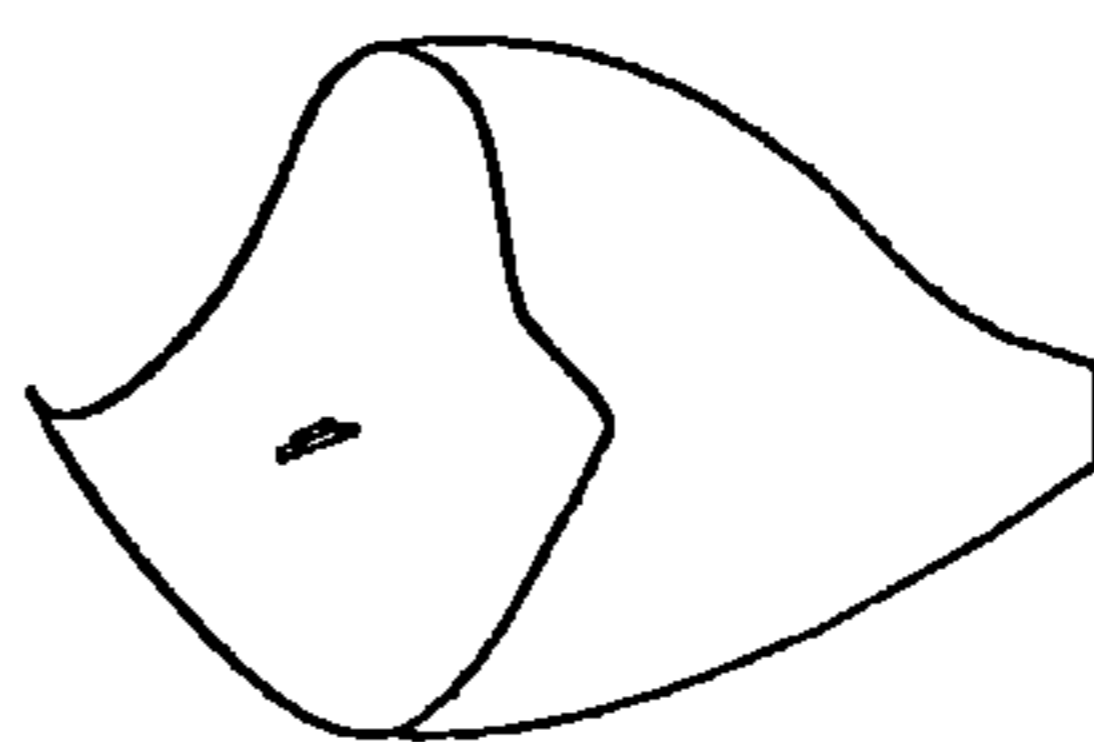

Fig. 200

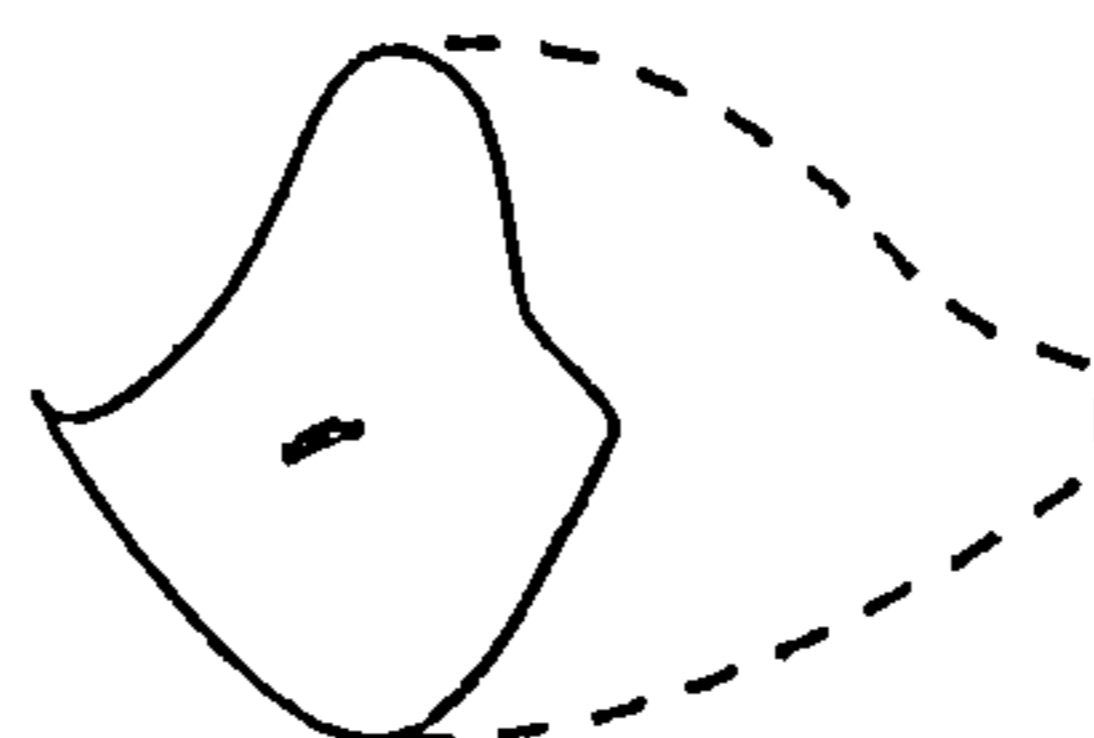

Fig. 201

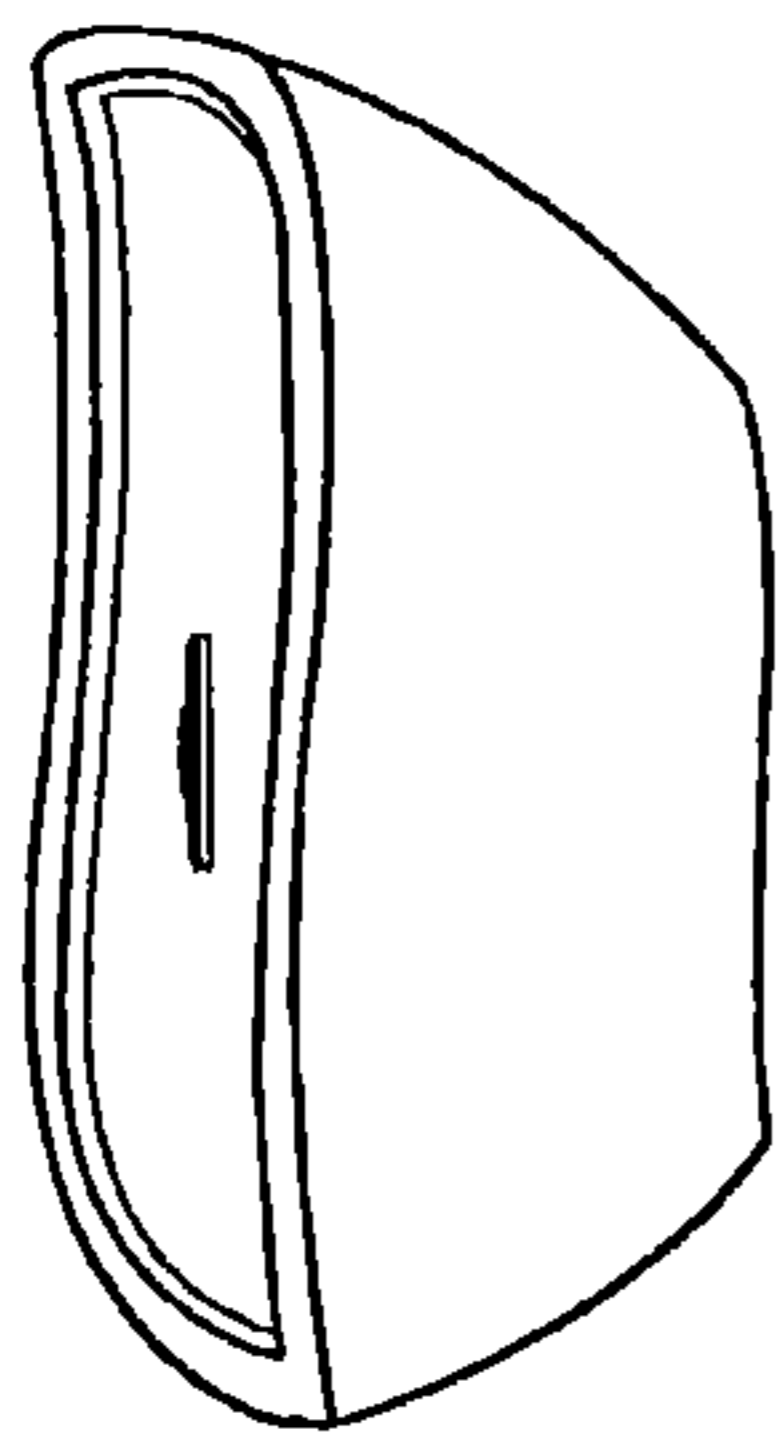

Fig. 202

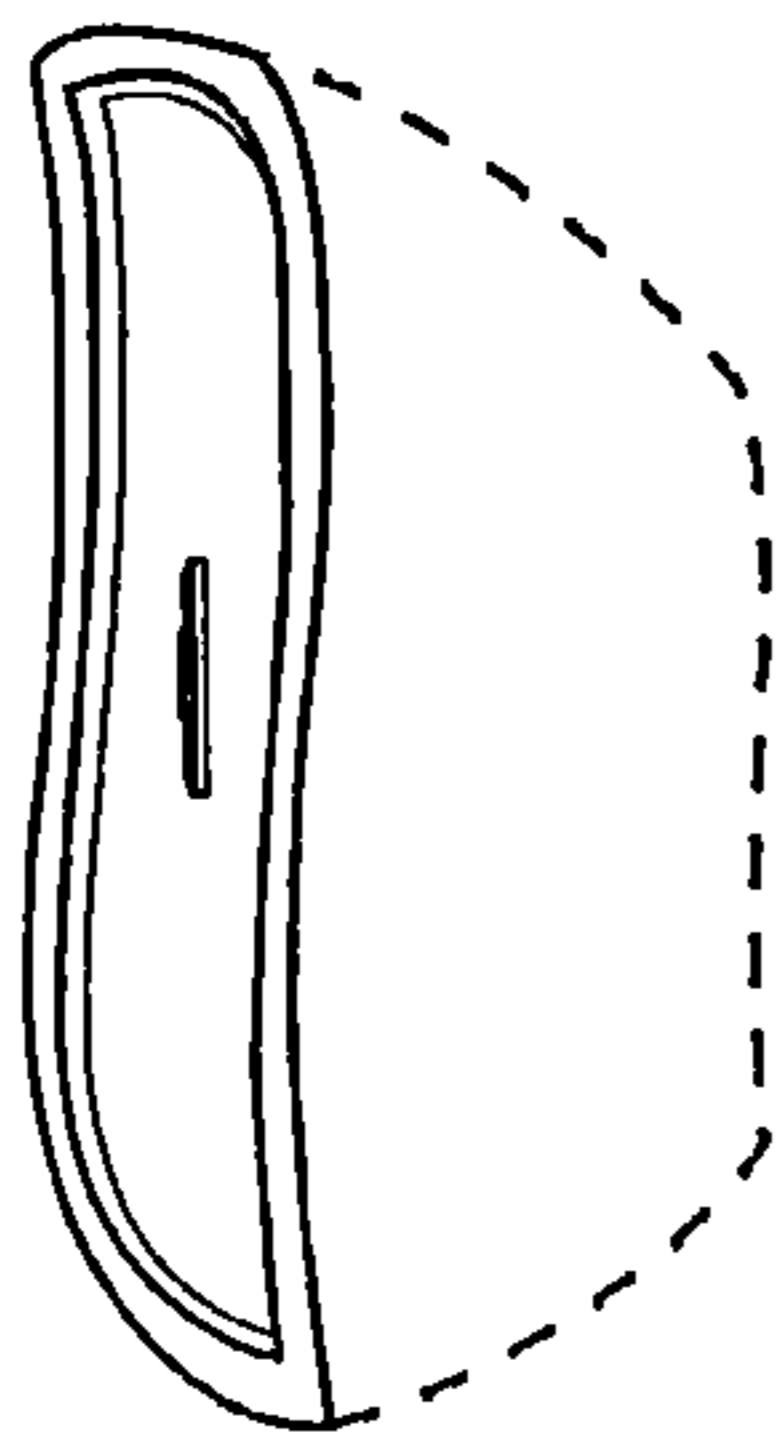

Fig. 203

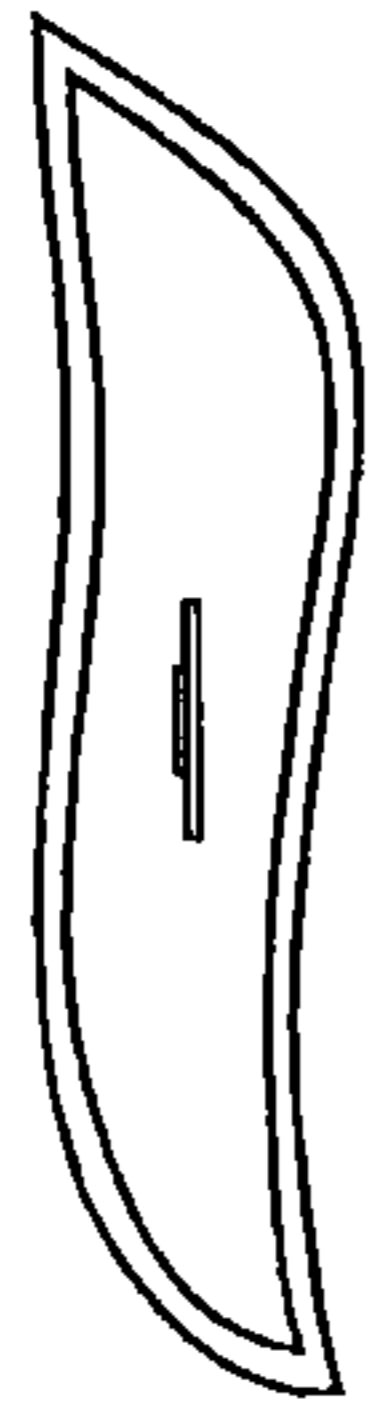

Fig. 204

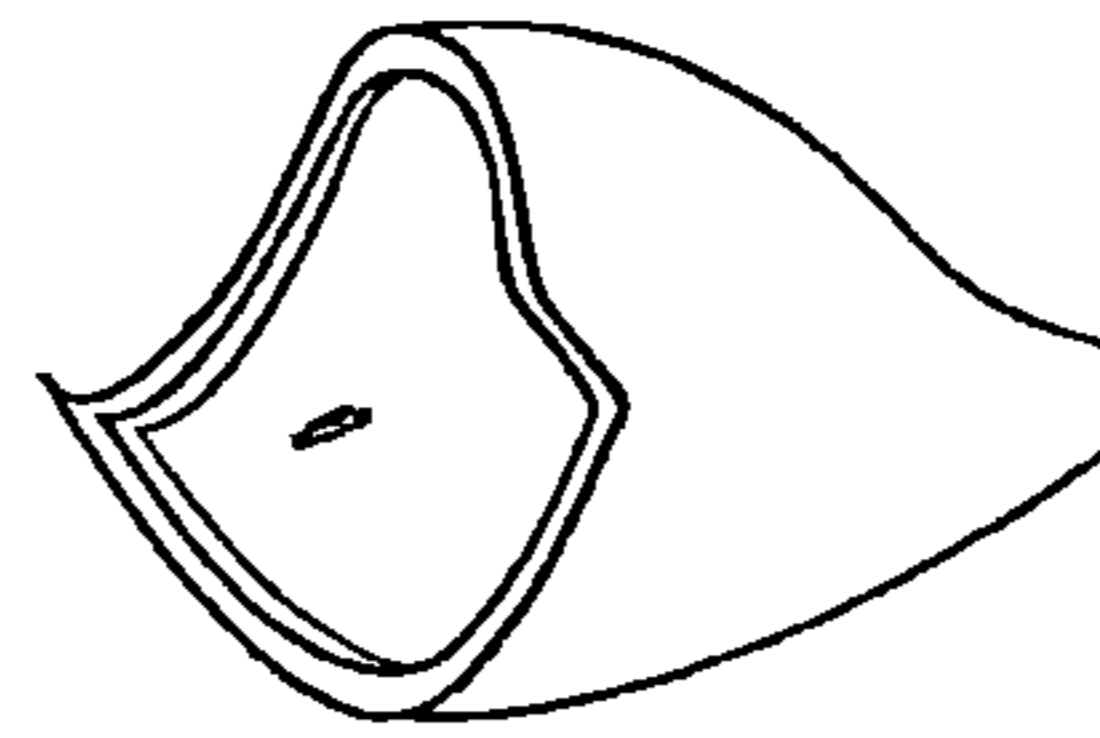

Fig. 205

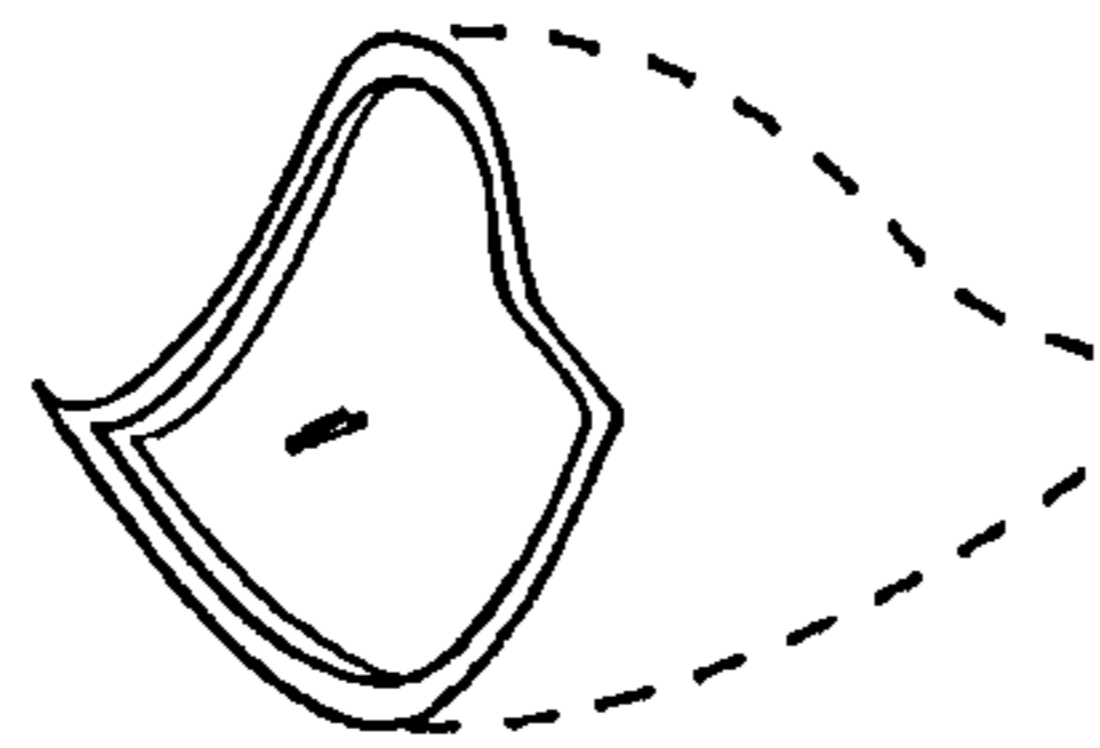

Fig. 206

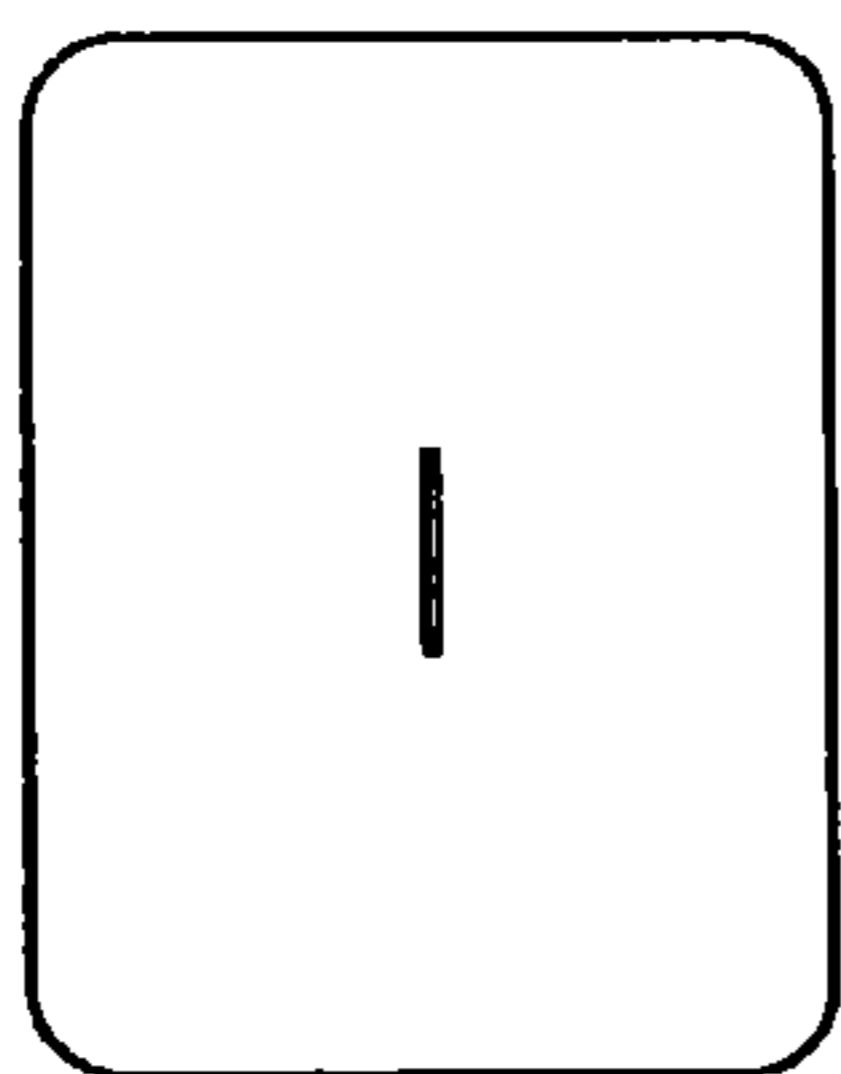

Fig. 209

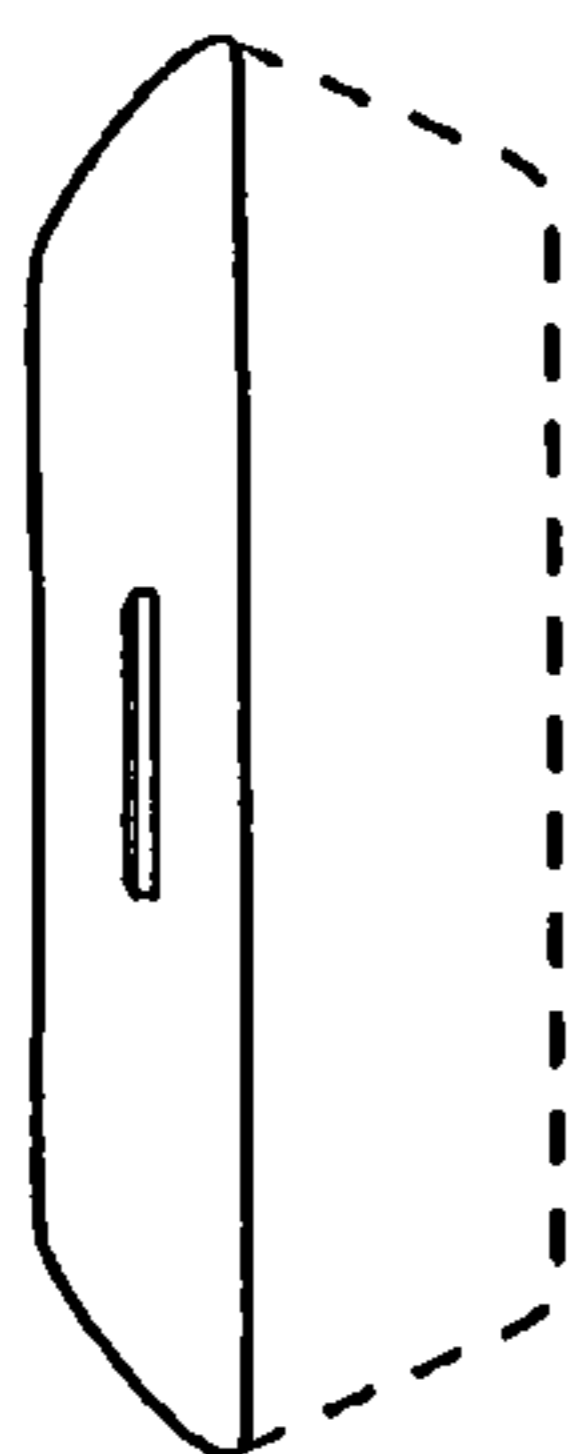

Fig. 208

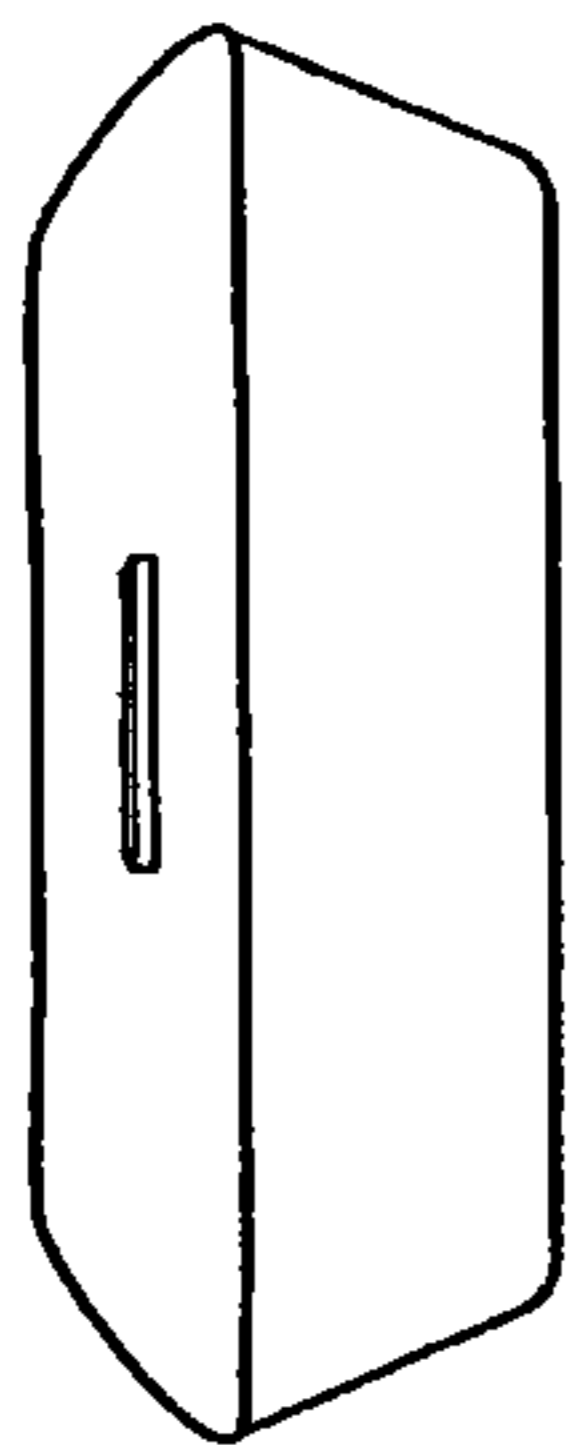

Fig. 207

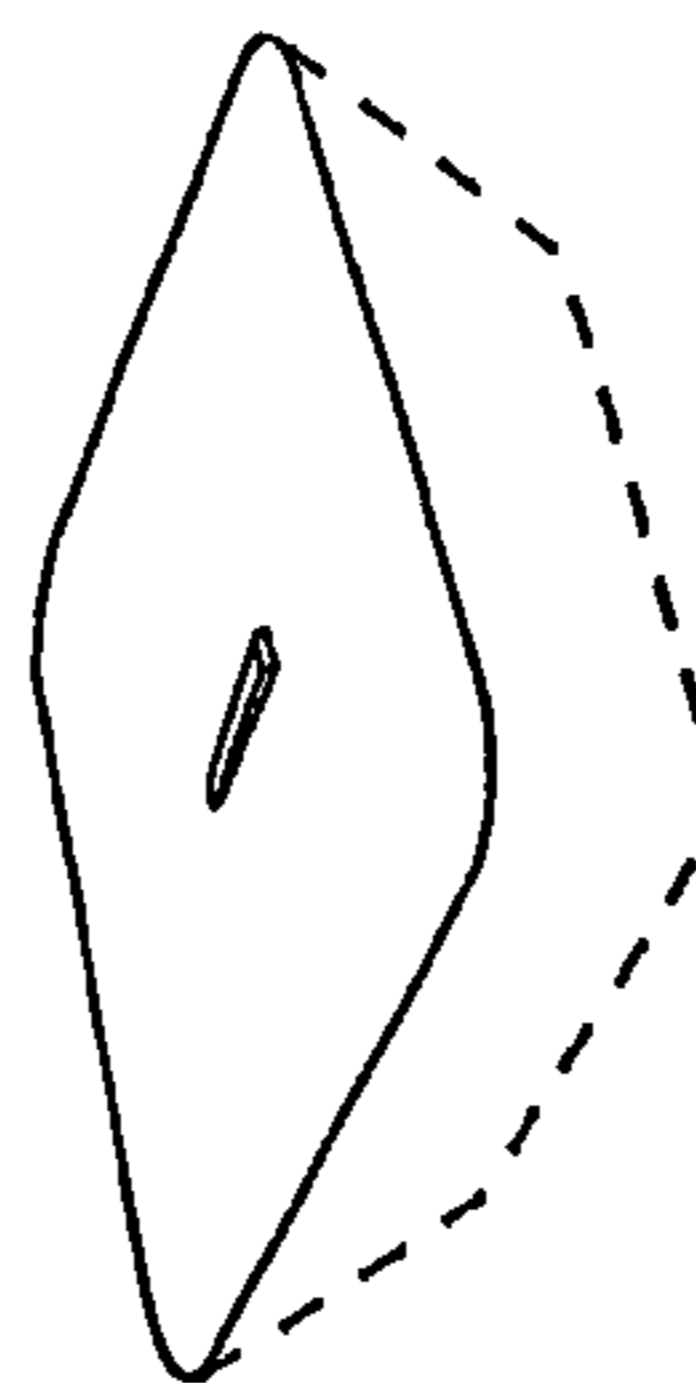

Fig. 211



Fig. 210

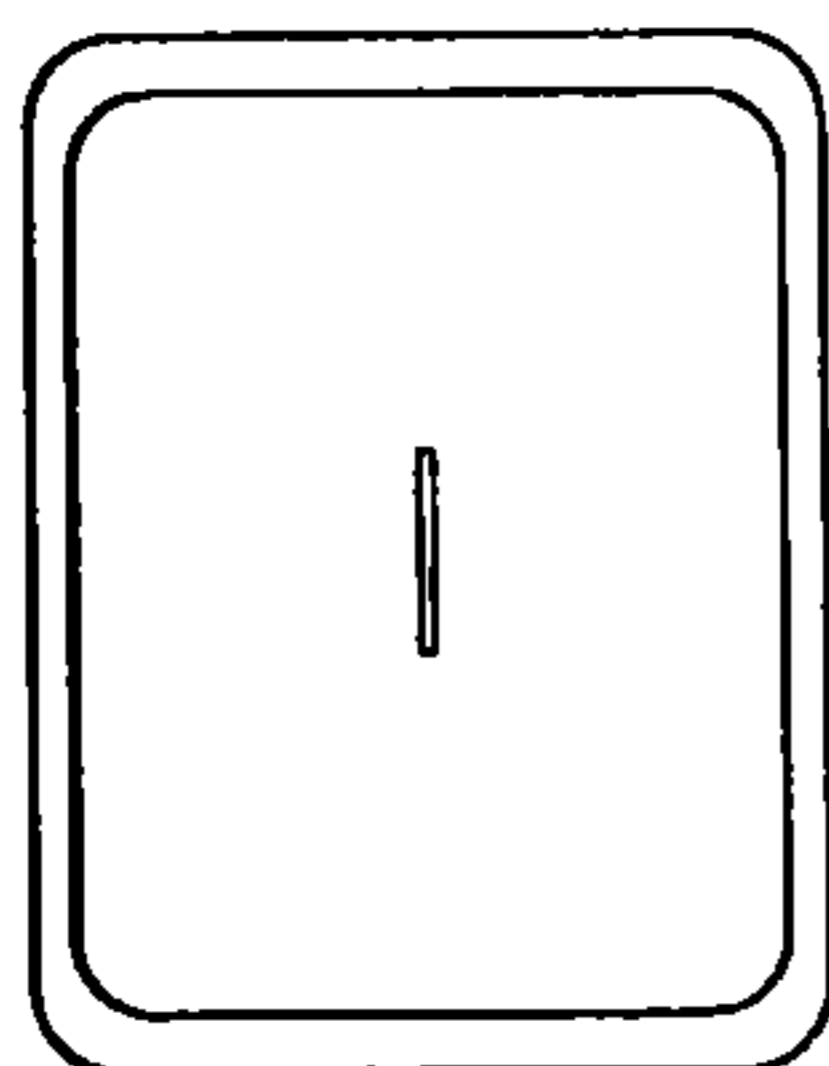

Fig. 214

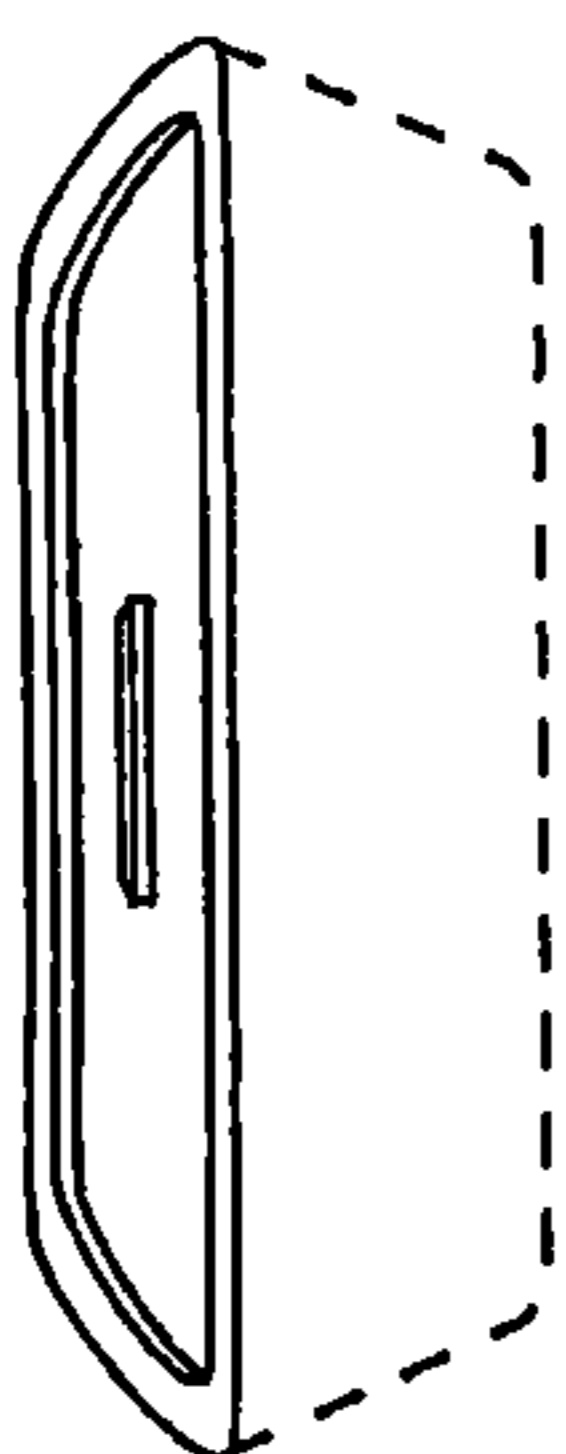

Fig. 213

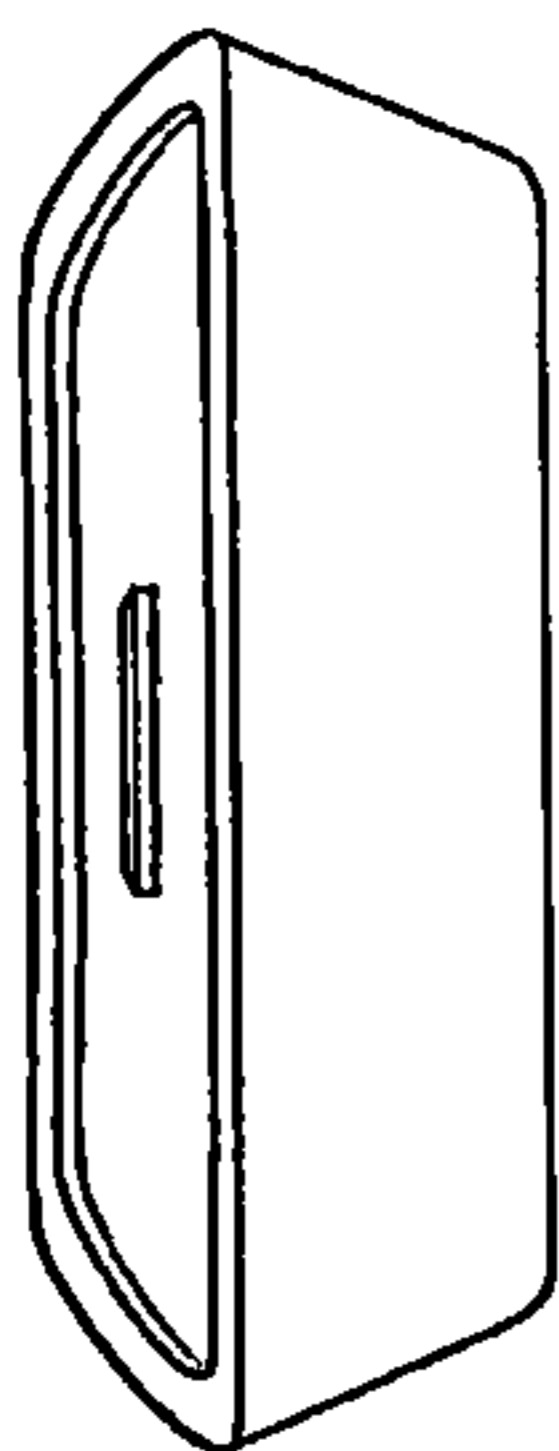

Fig. 212

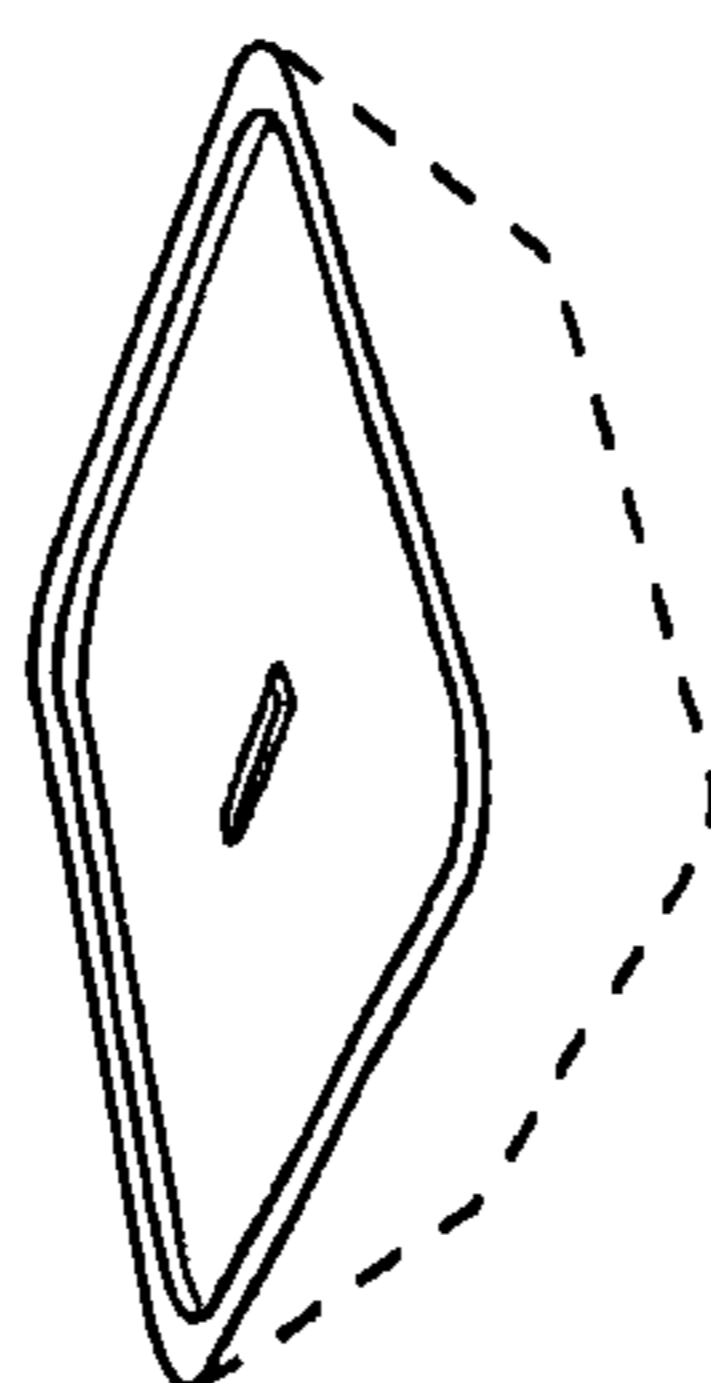

Fig. 216

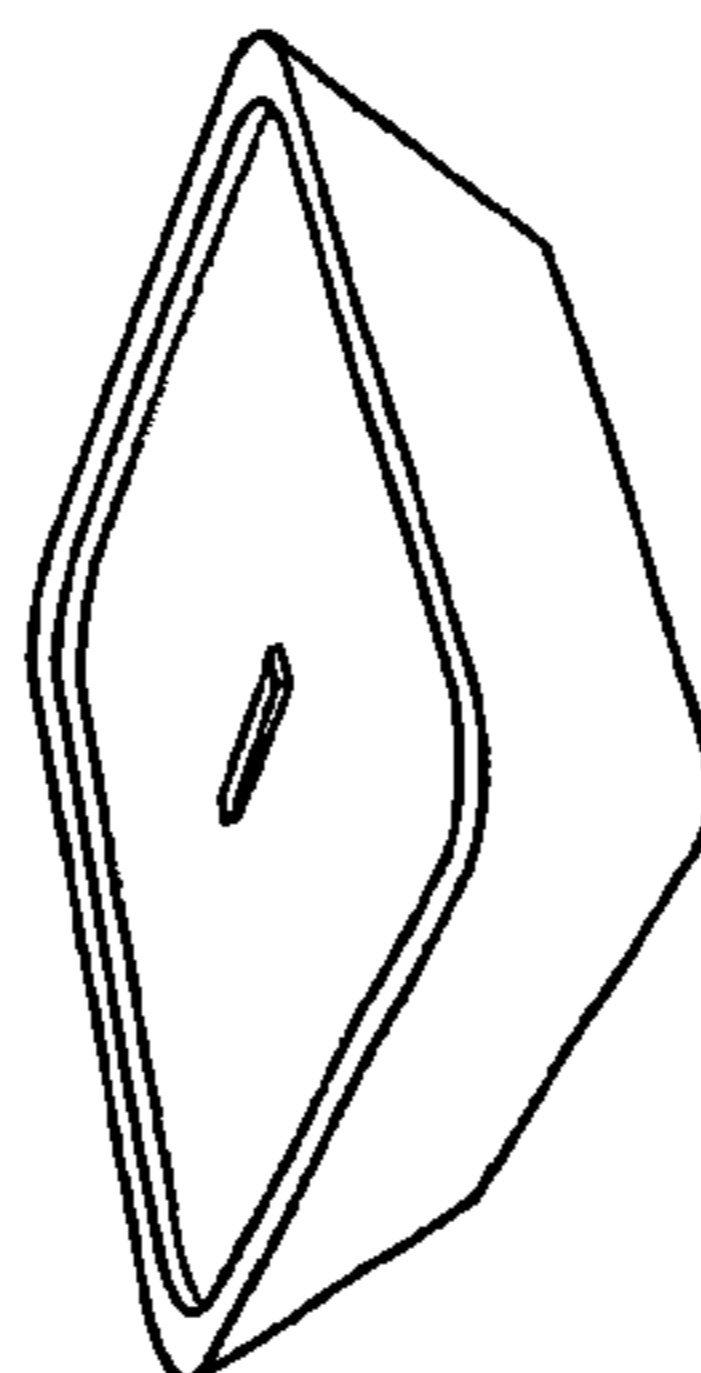

Fig. 215

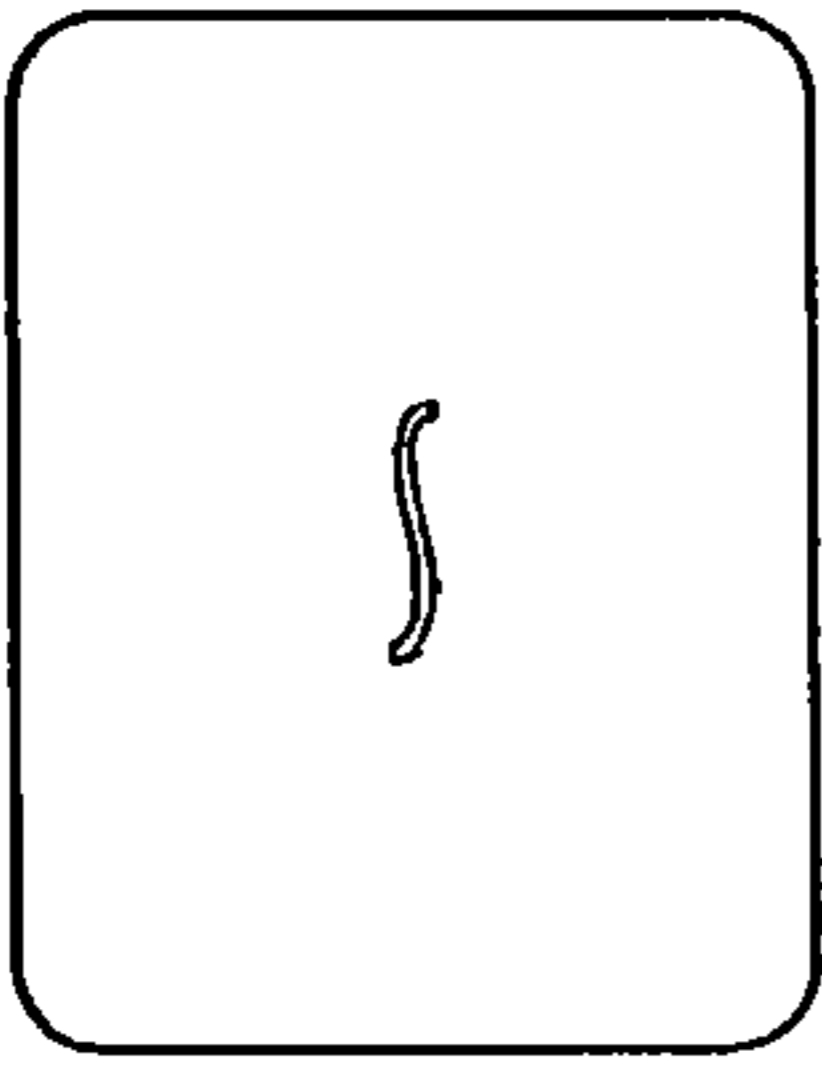

Fig. 219

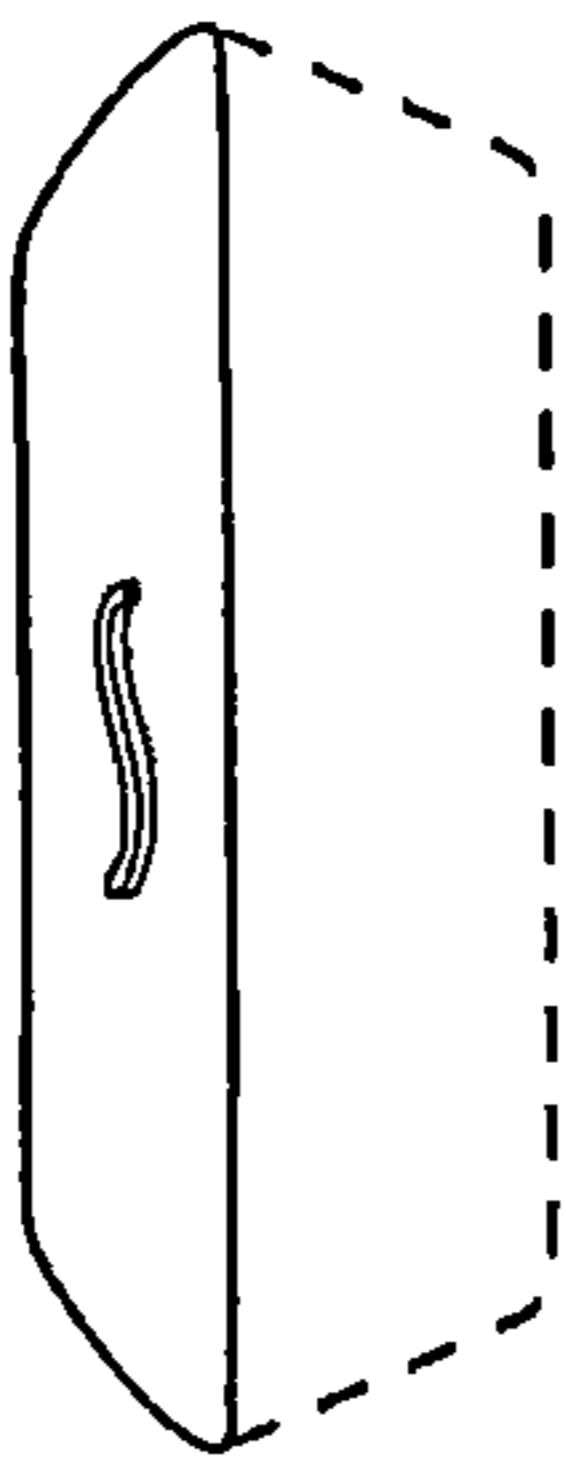

Fig. 218

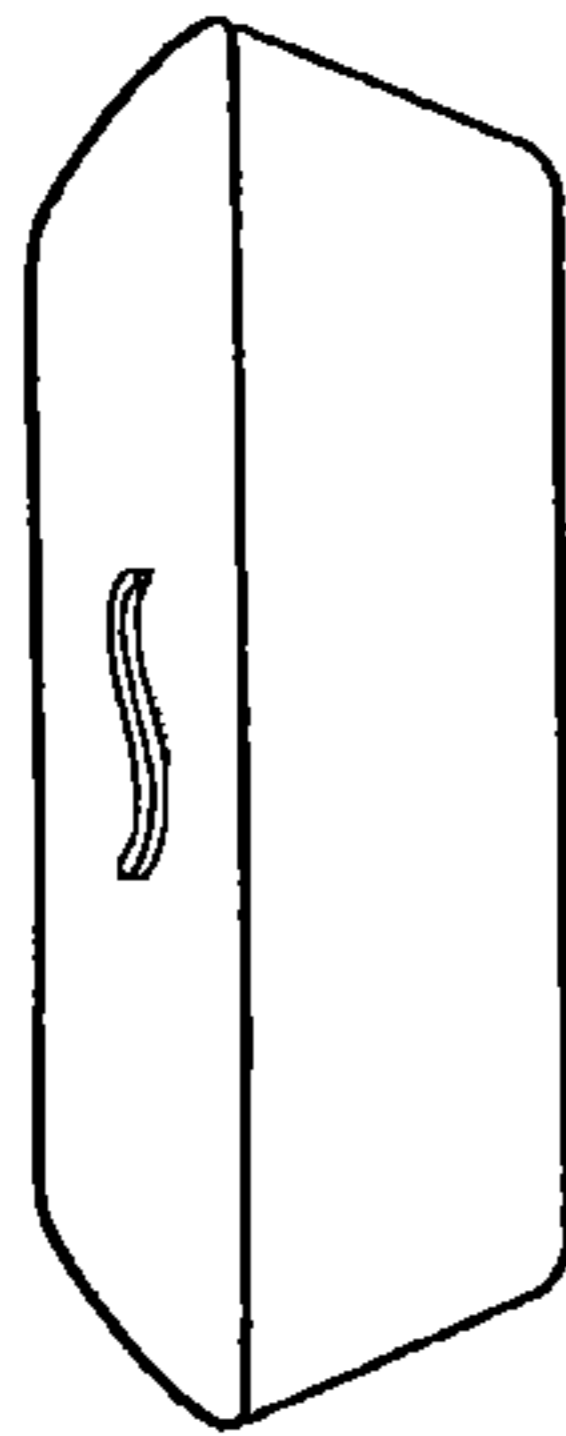

Fig. 217

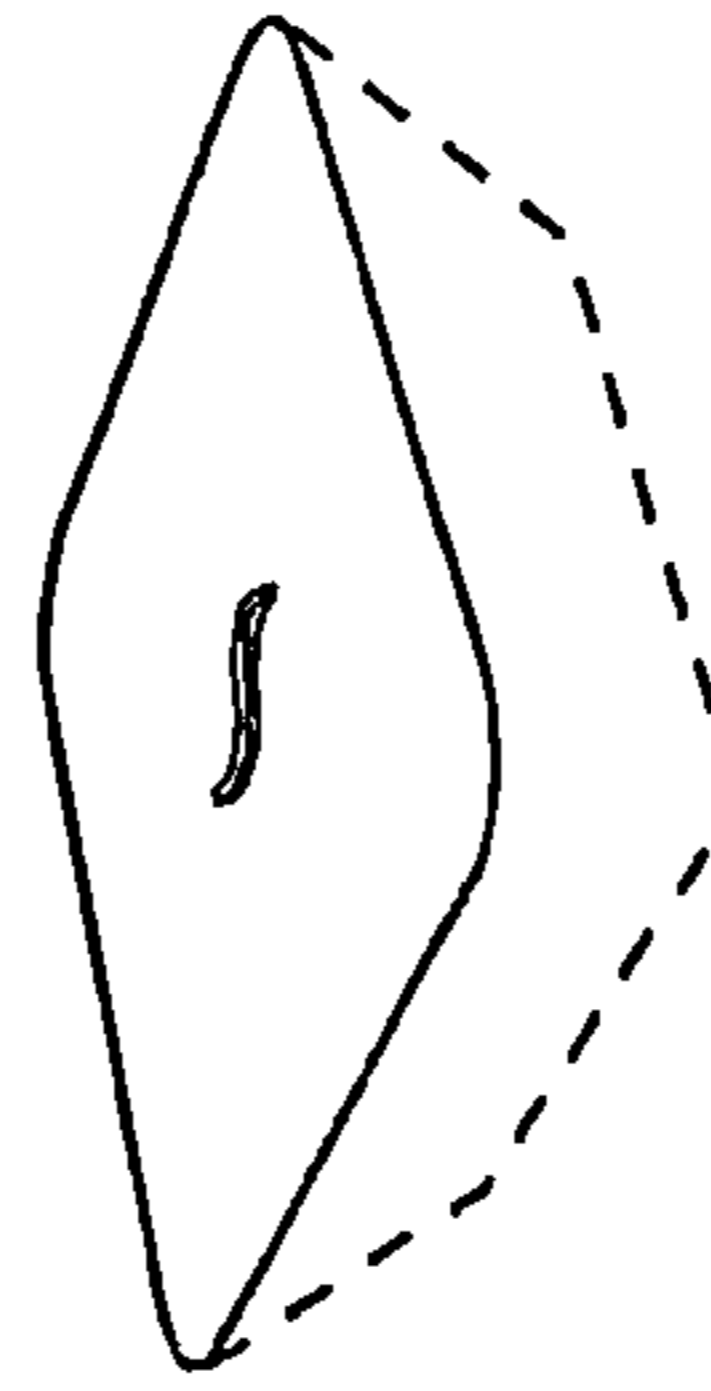

Fig. 221

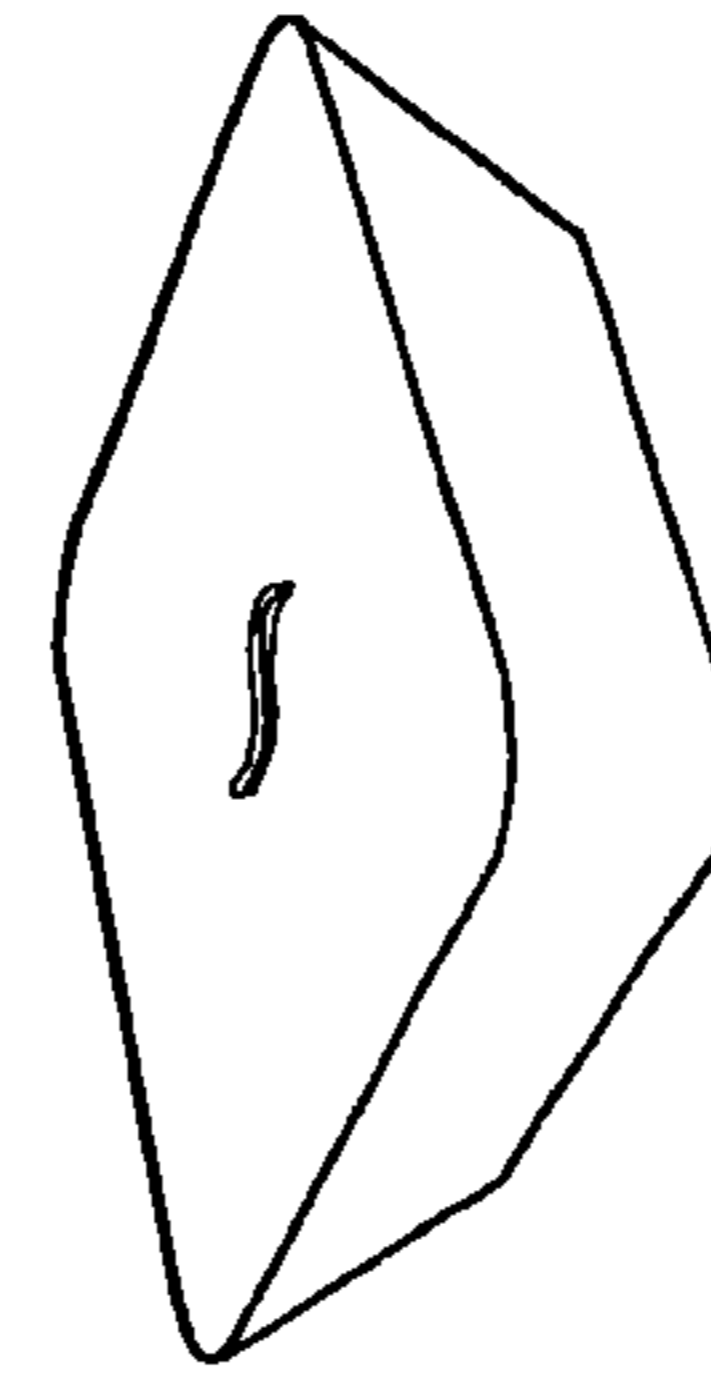

Fig. 220

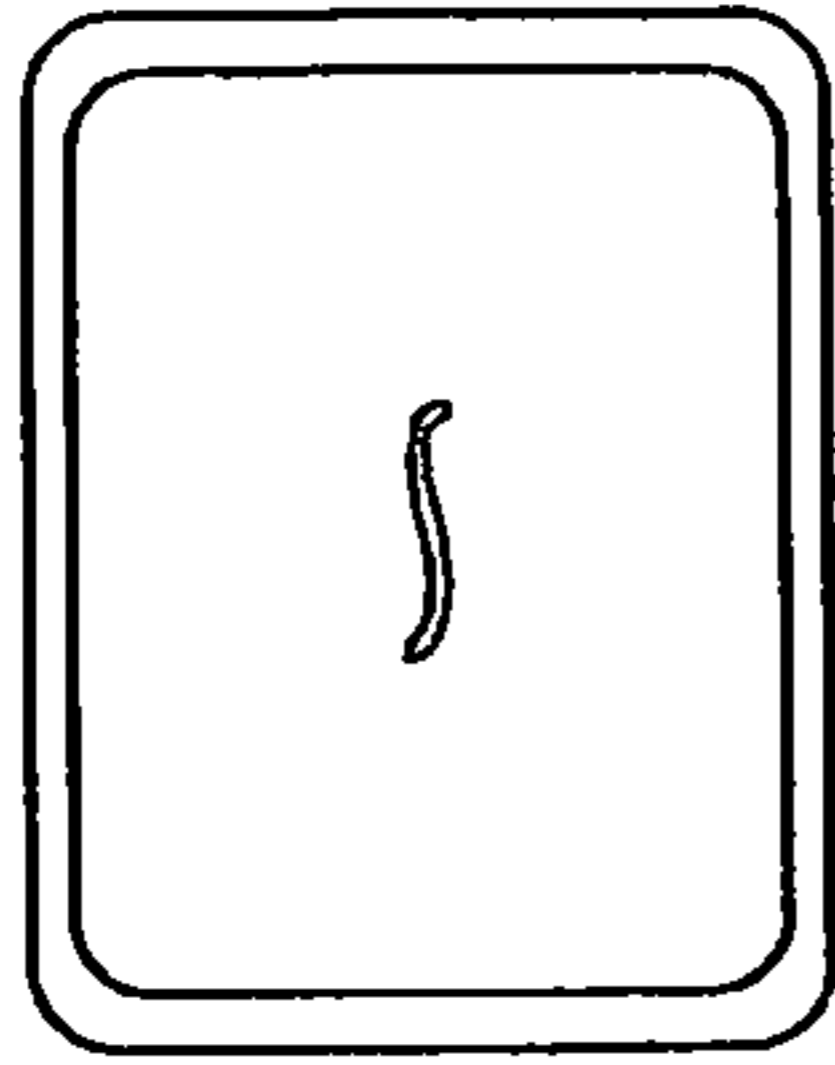

Fig. 224

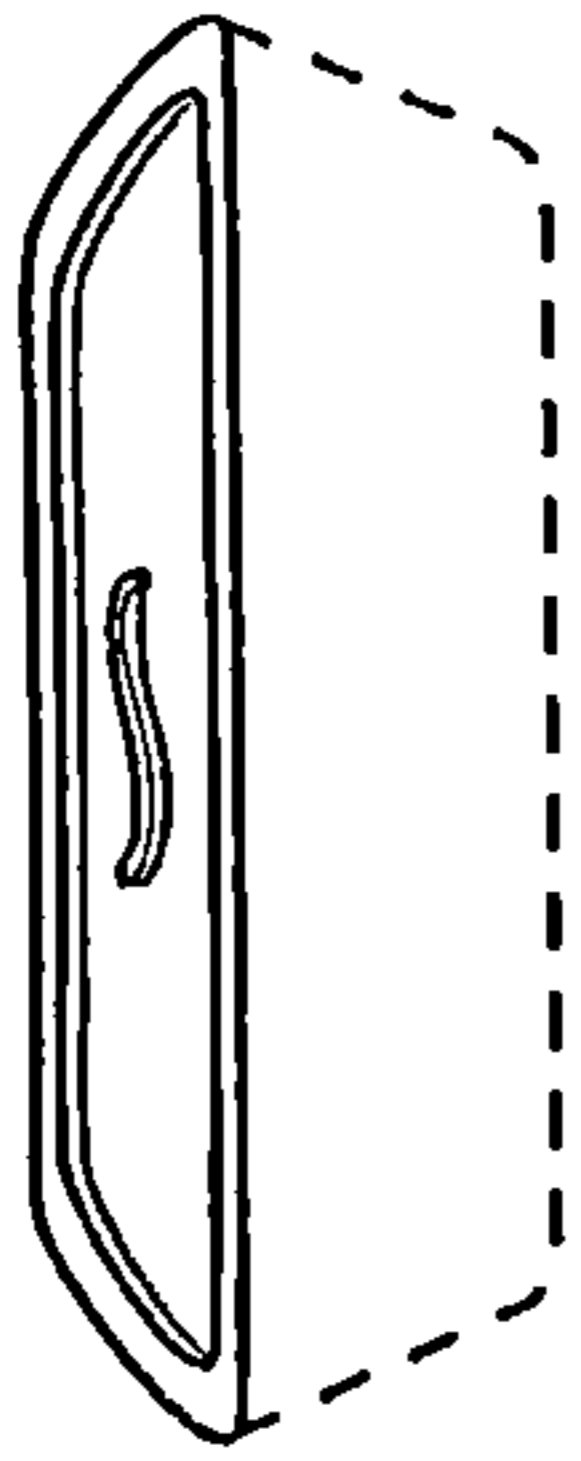

Fig. 223

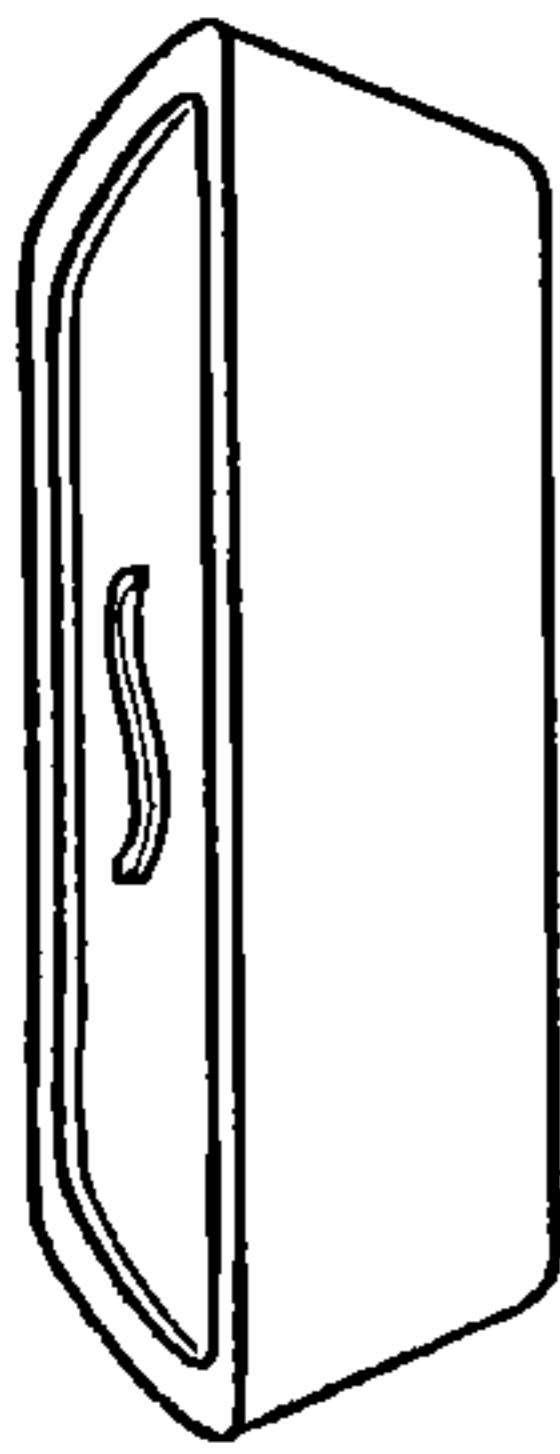

Fig. 222

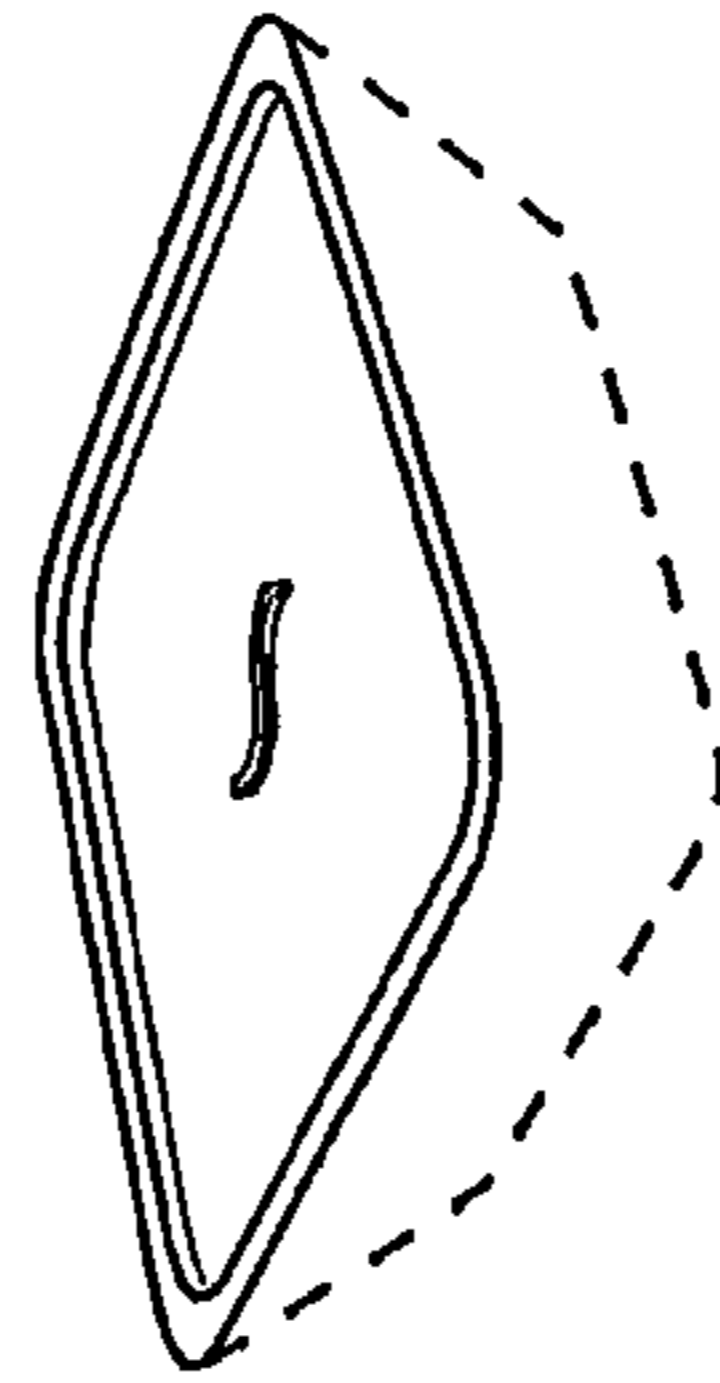

Fig. 226

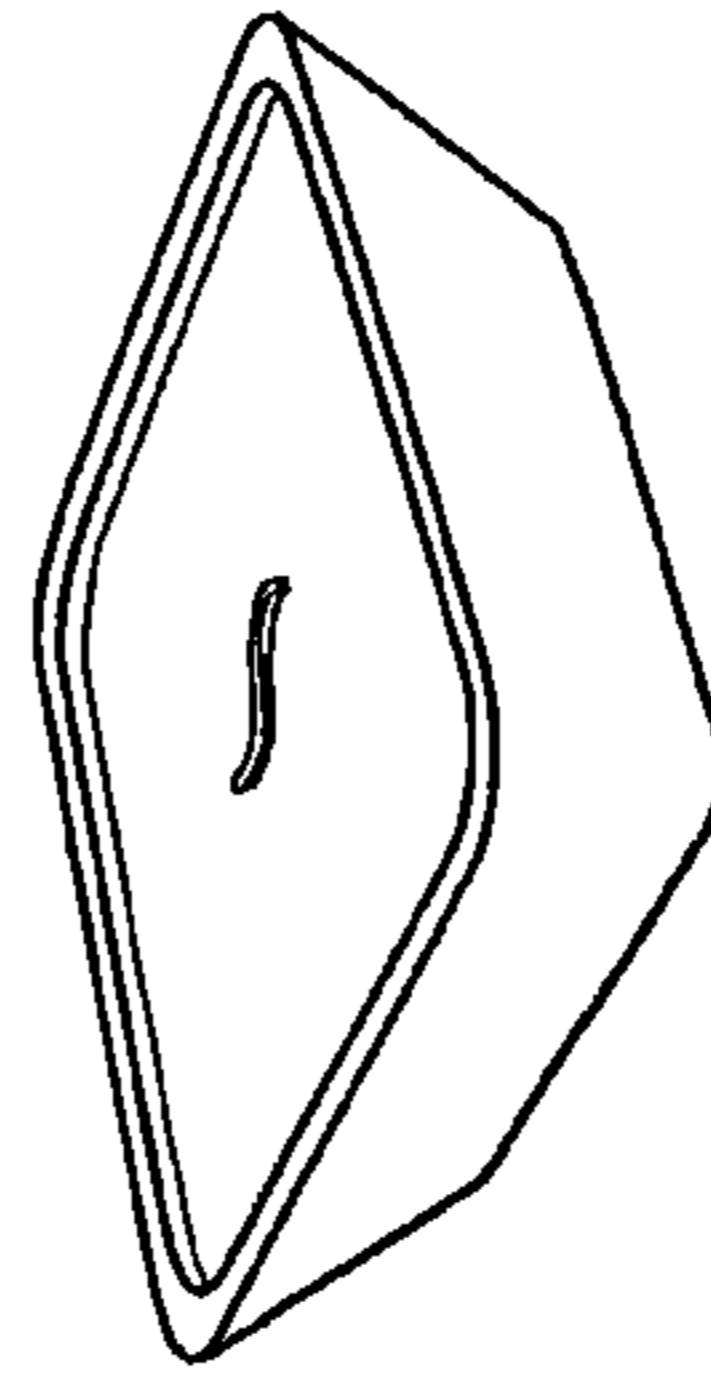

Fig. 225

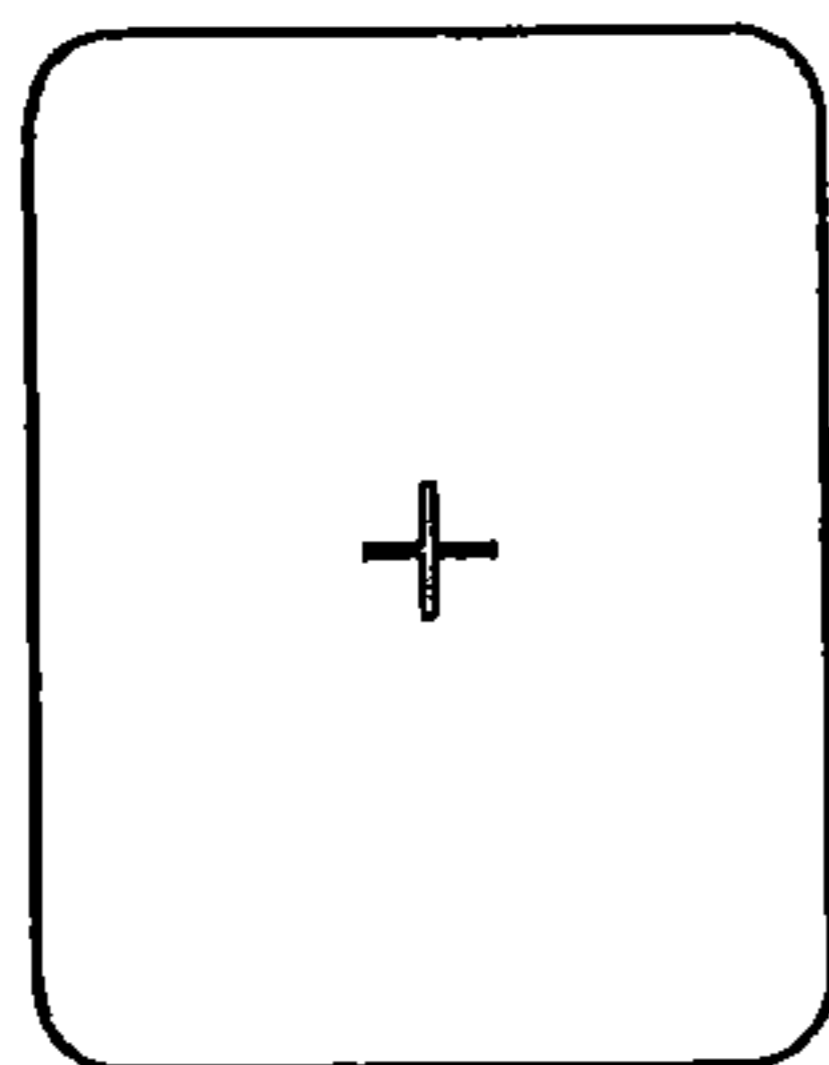

Fig. 229

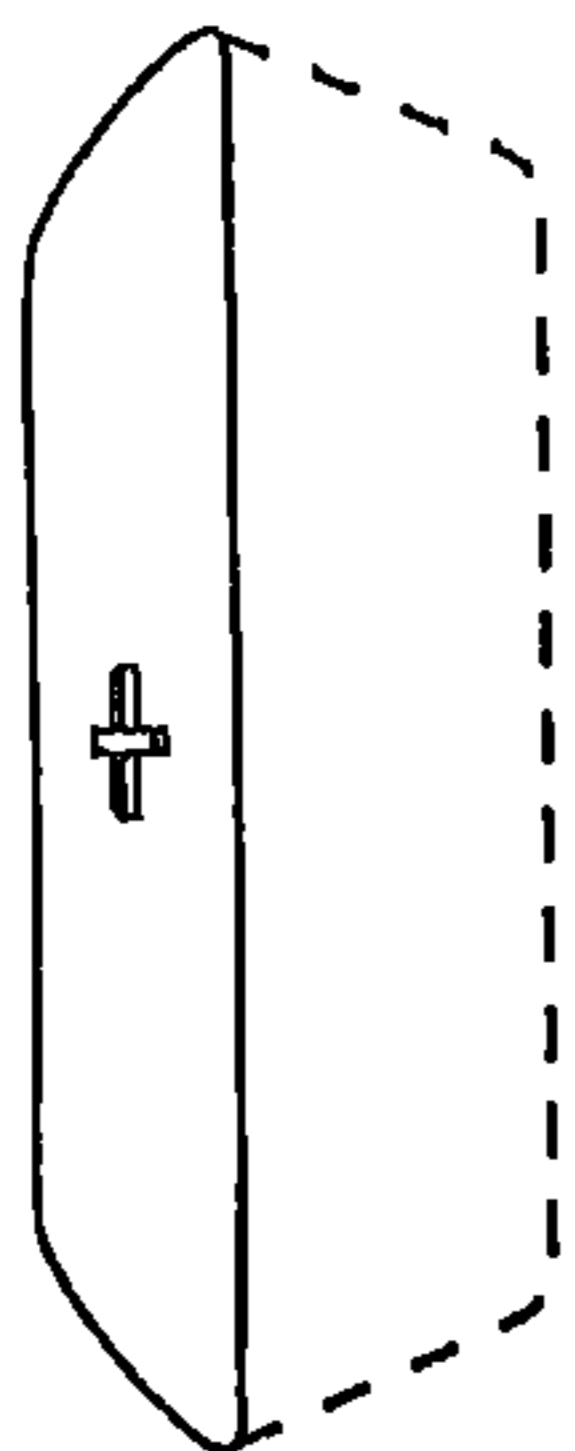

Fig. 228

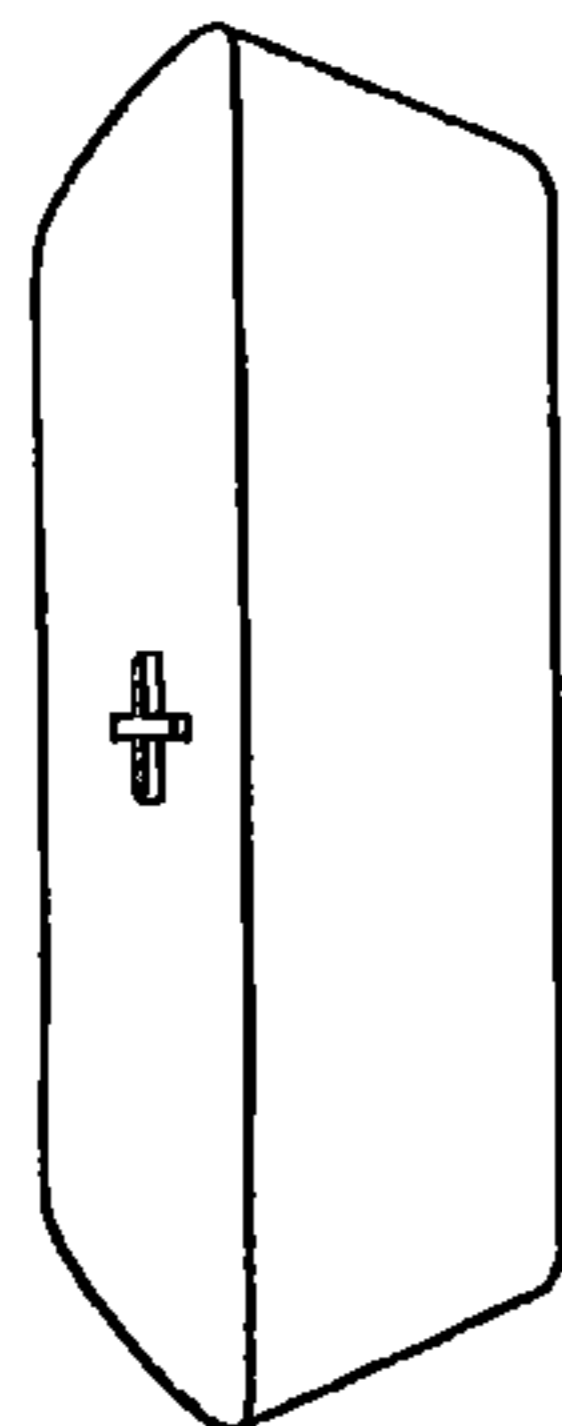

Fig. 227

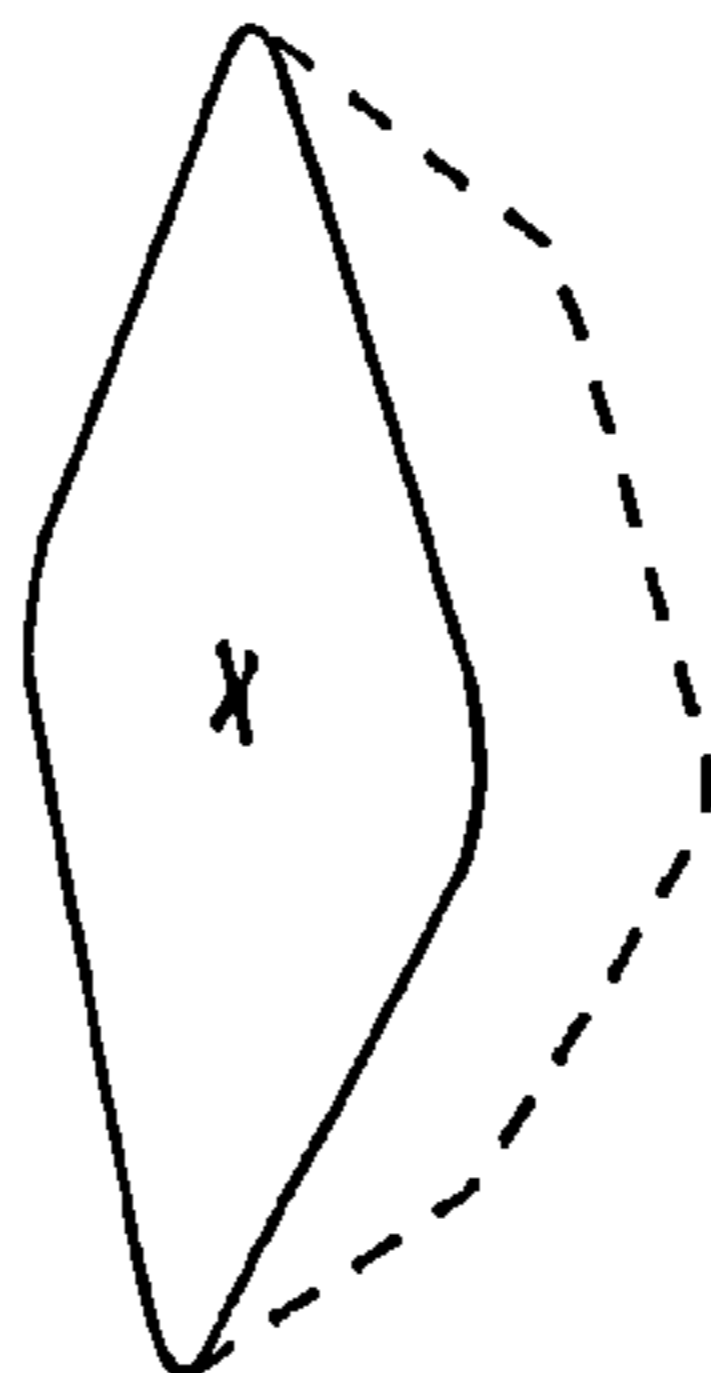

Fig. 231

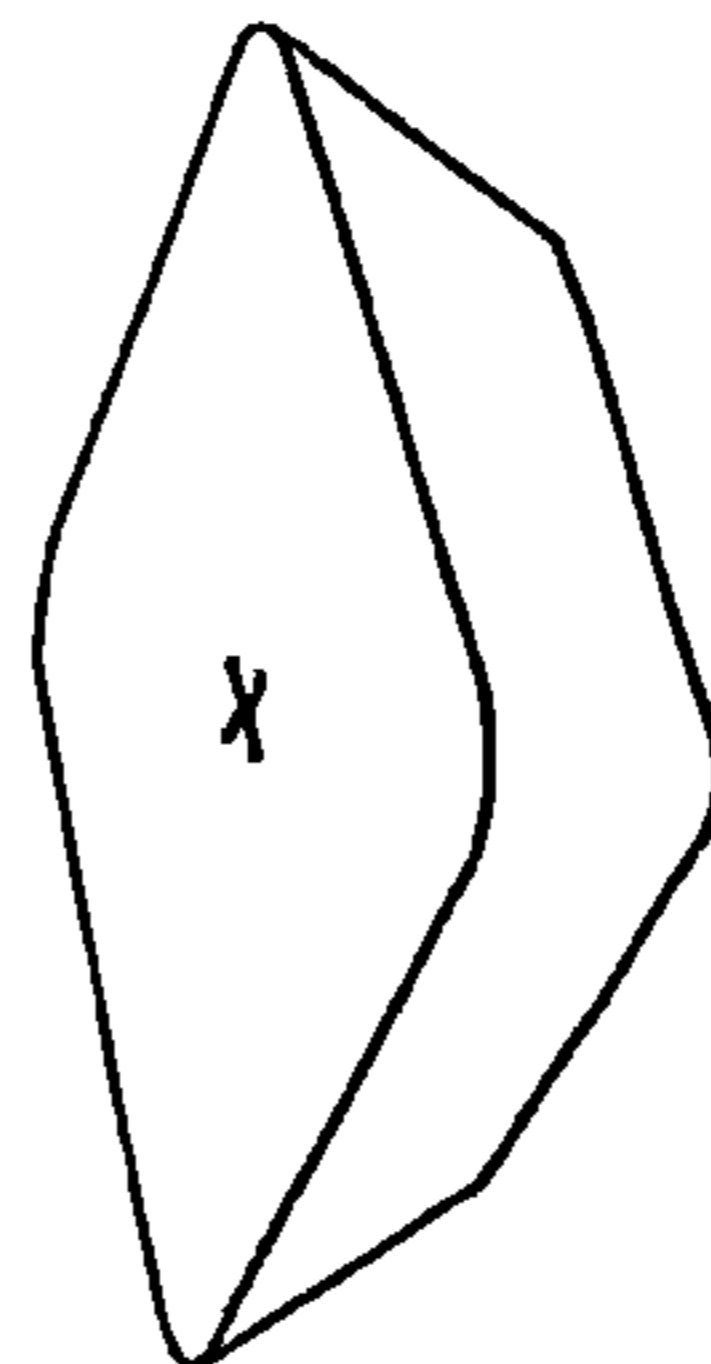

Fig. 230

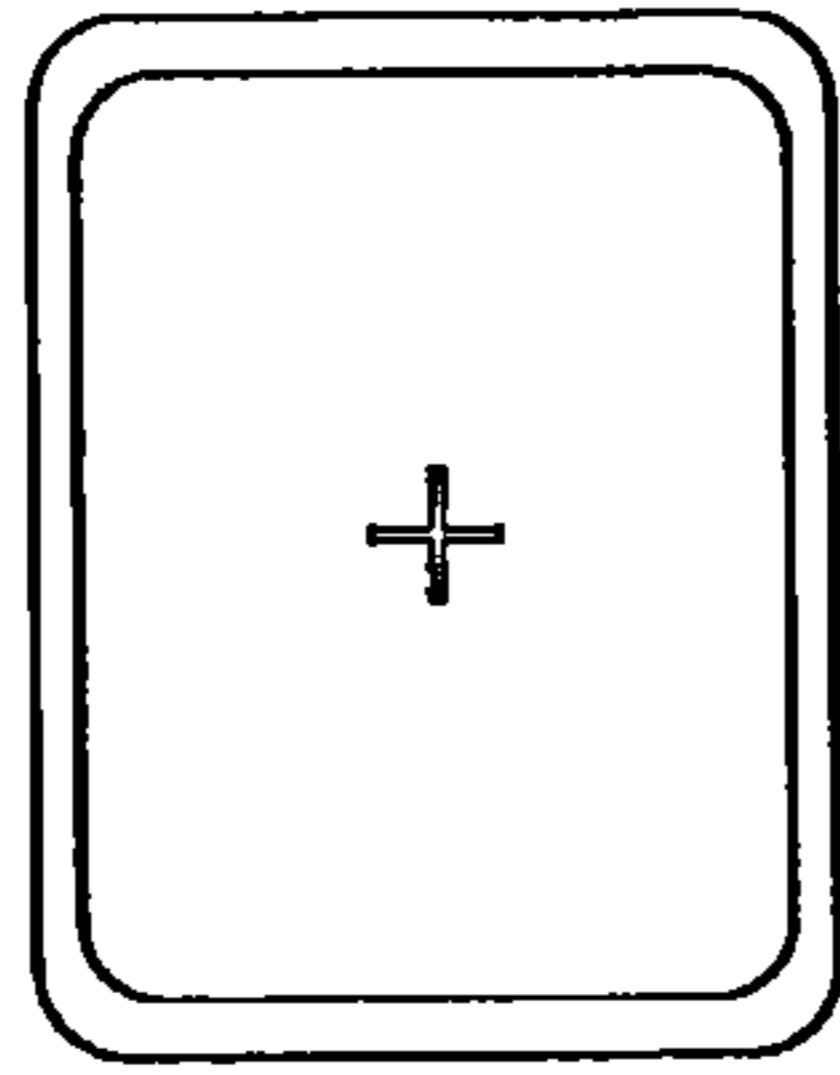

Fig. 234

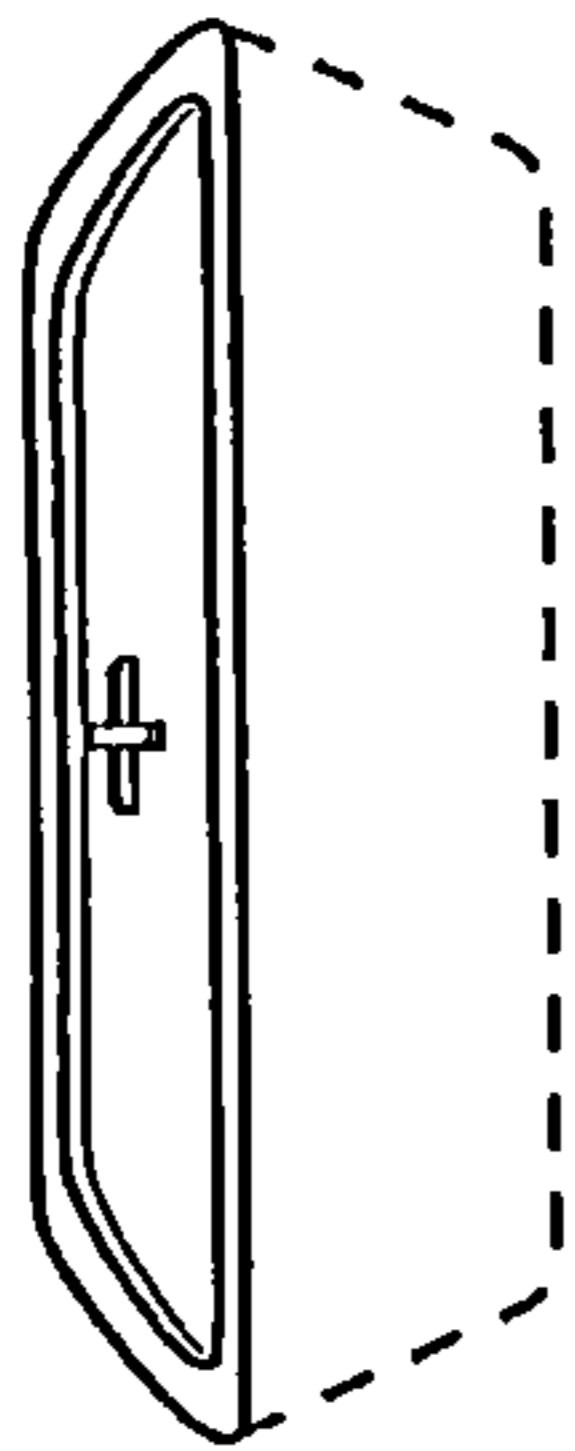

Fig. 233

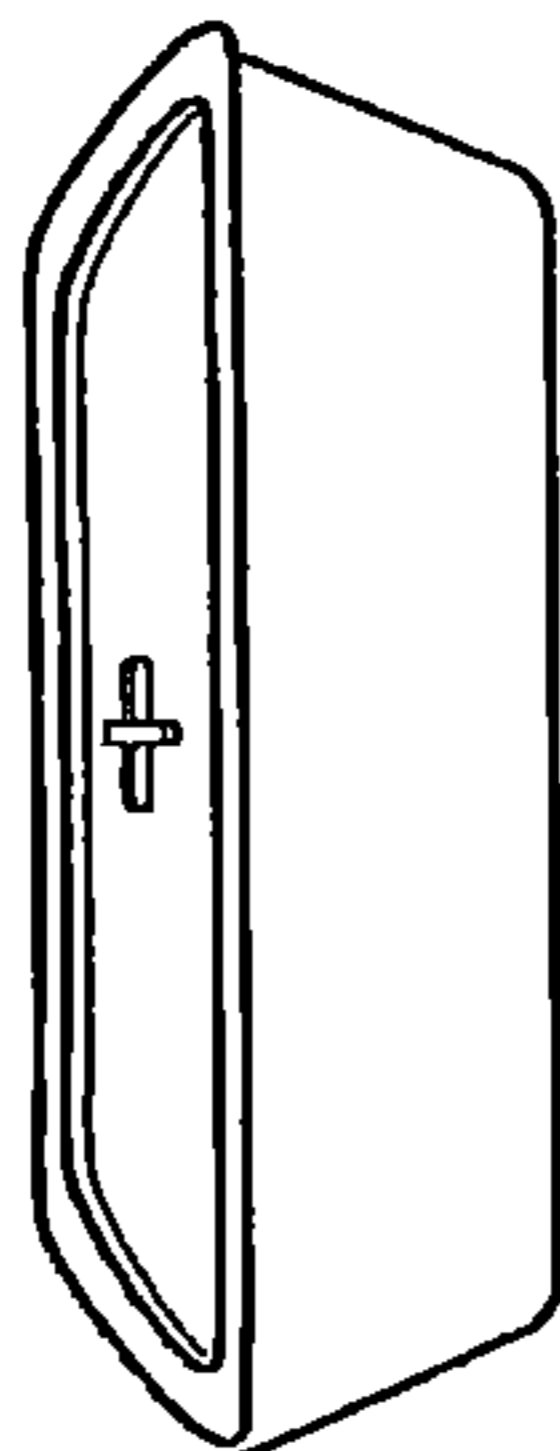

Fig. 232

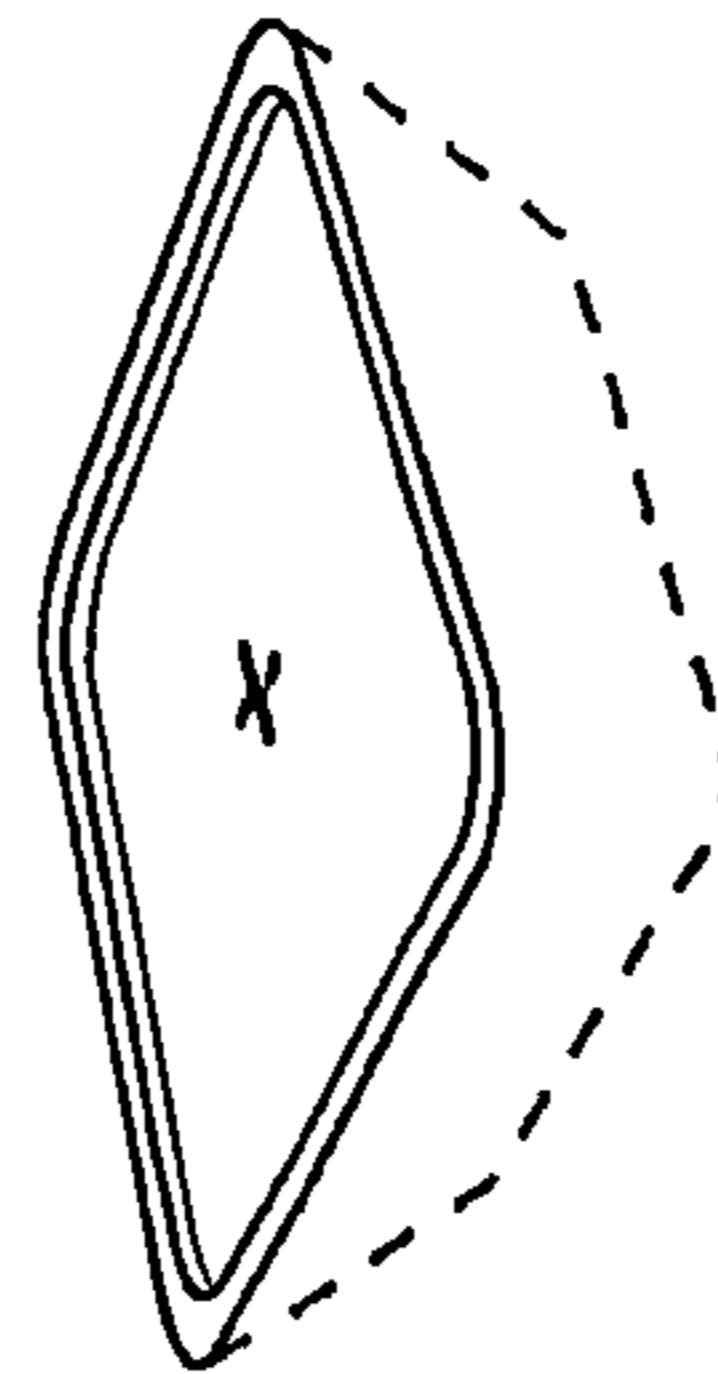

Fig. 236

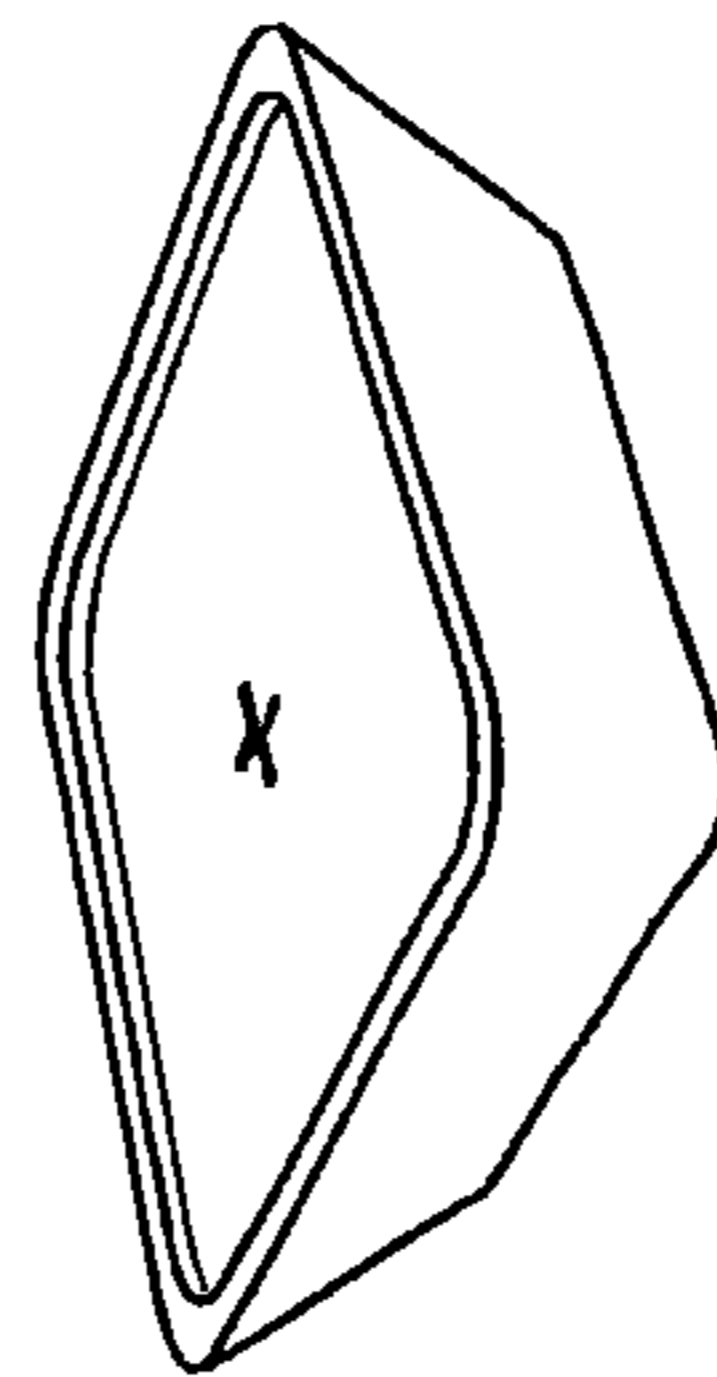

Fig. 235

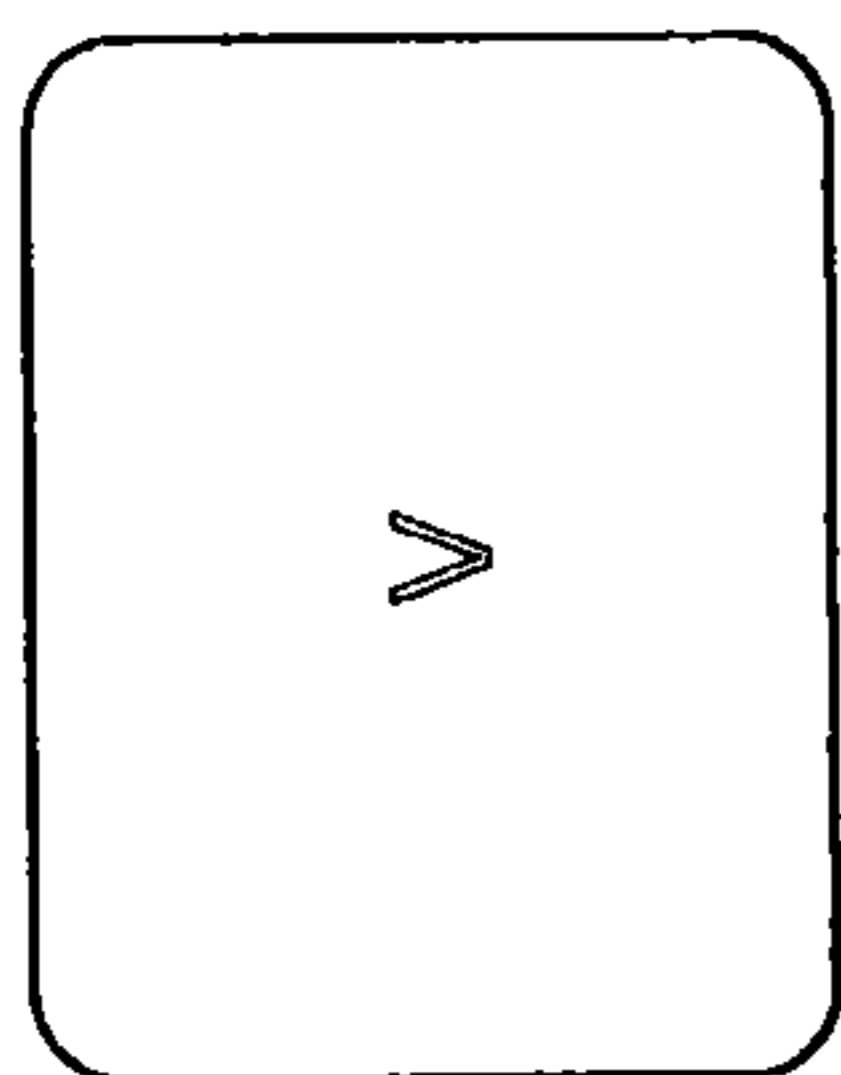

Fig. 239

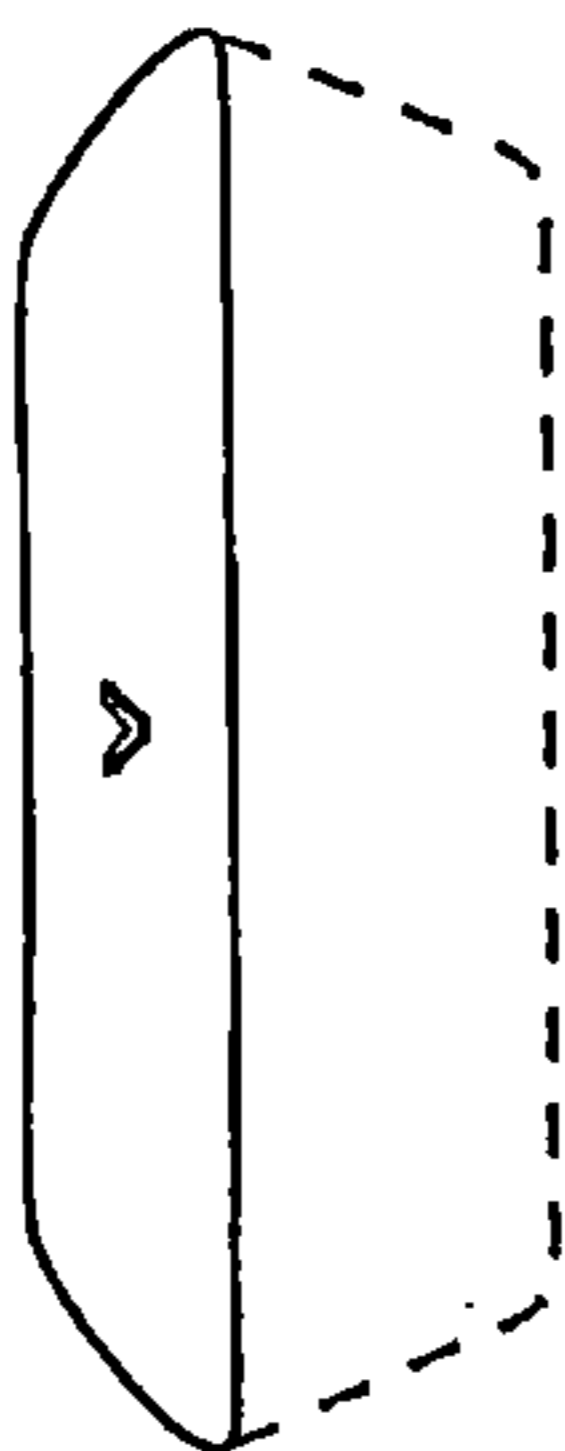

Fig. 238

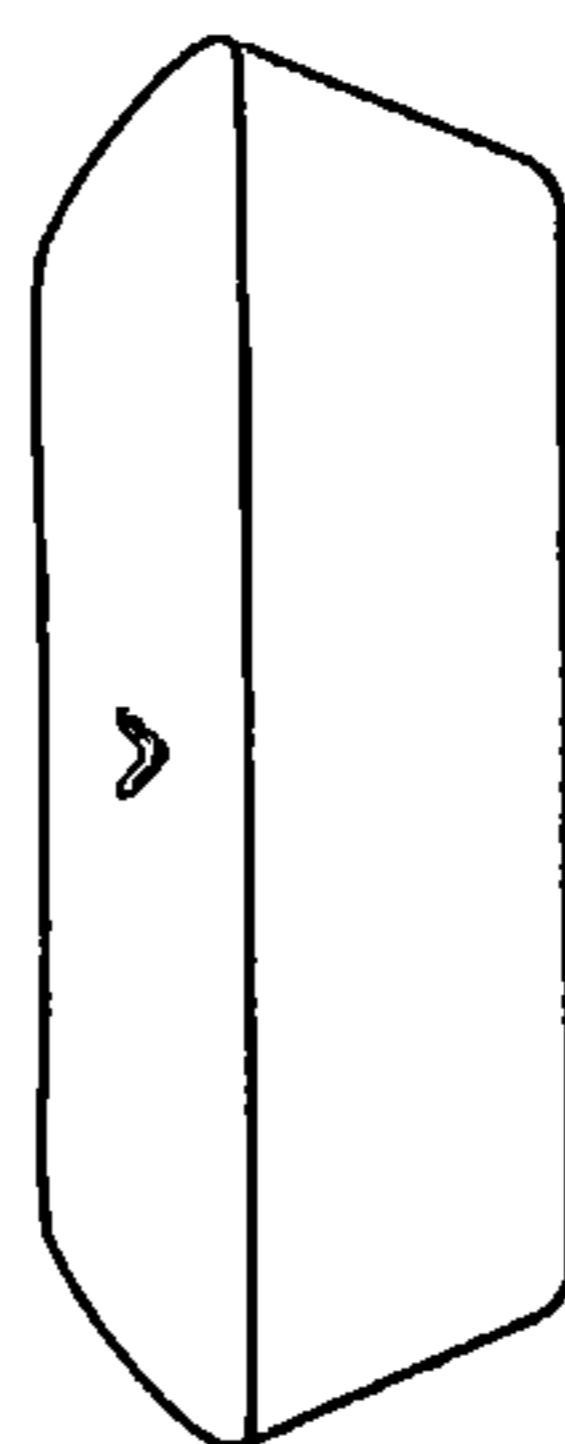

Fig. 237

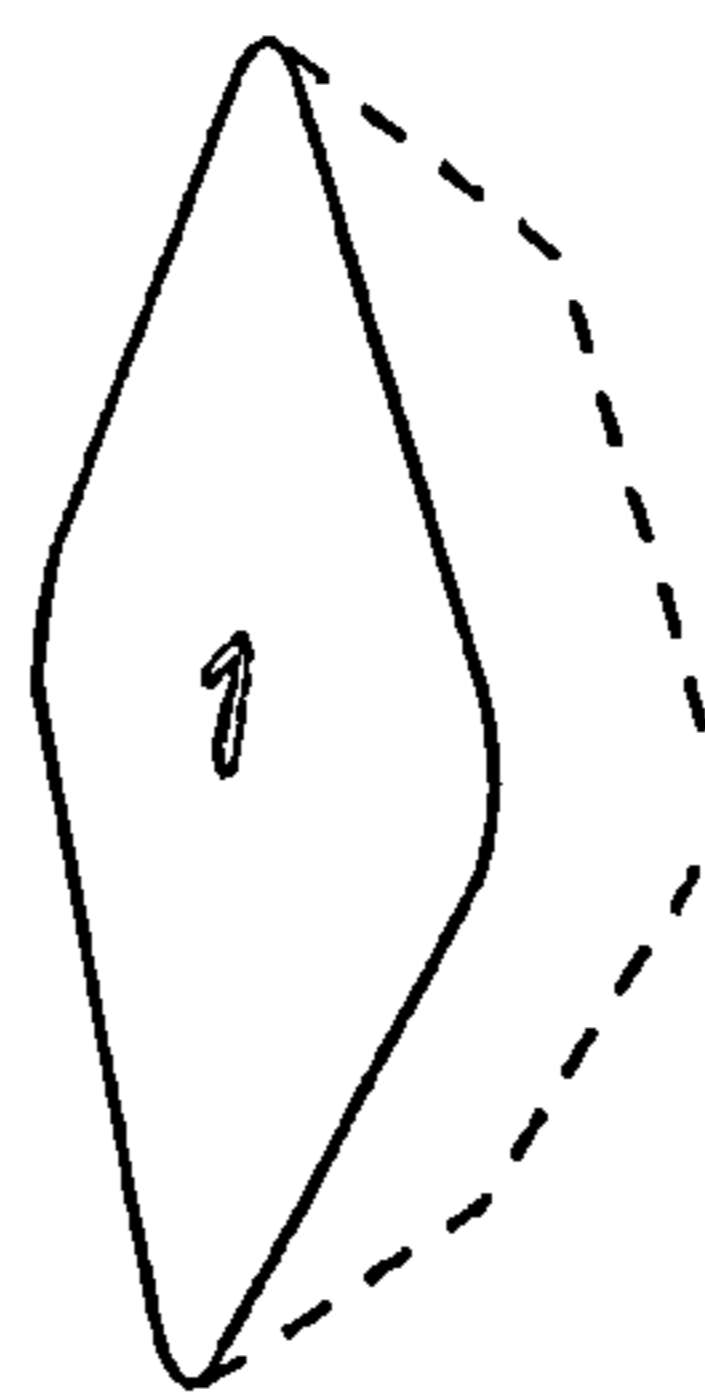

Fig. 241

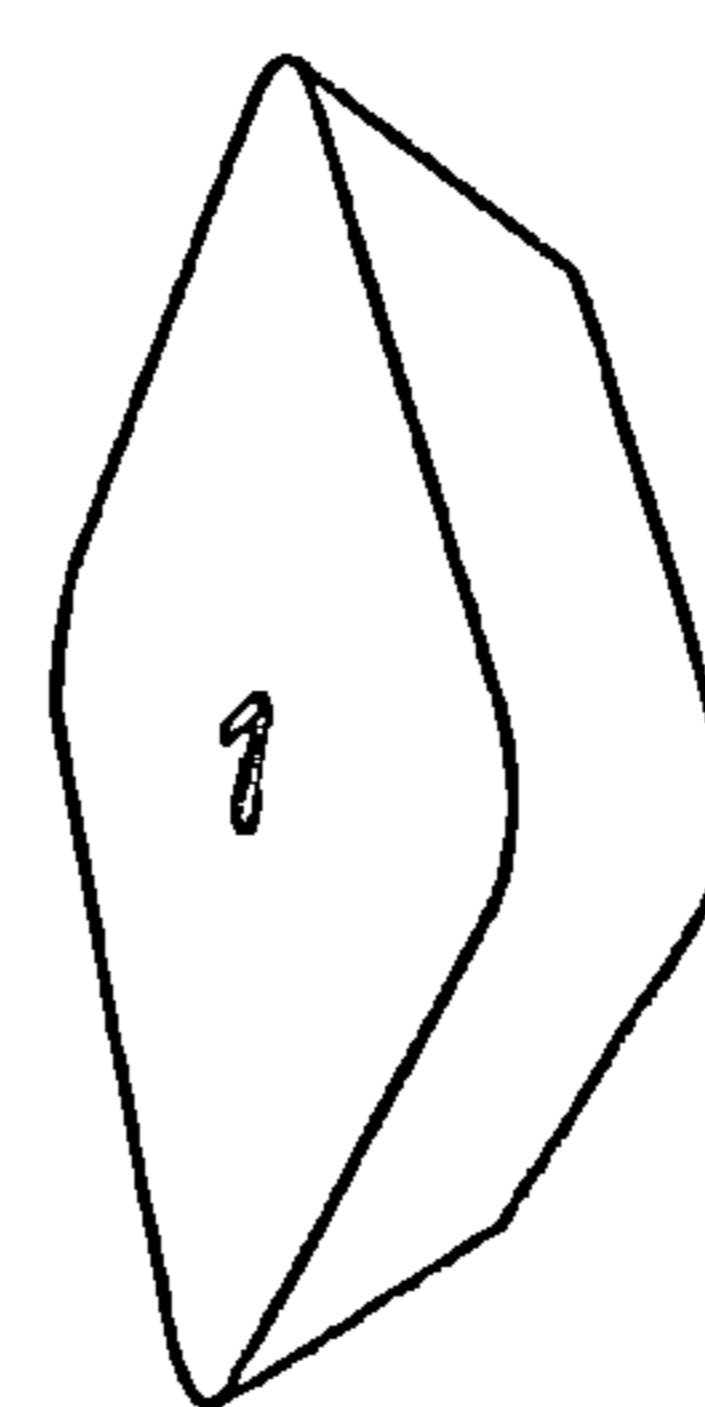

Fig. 240

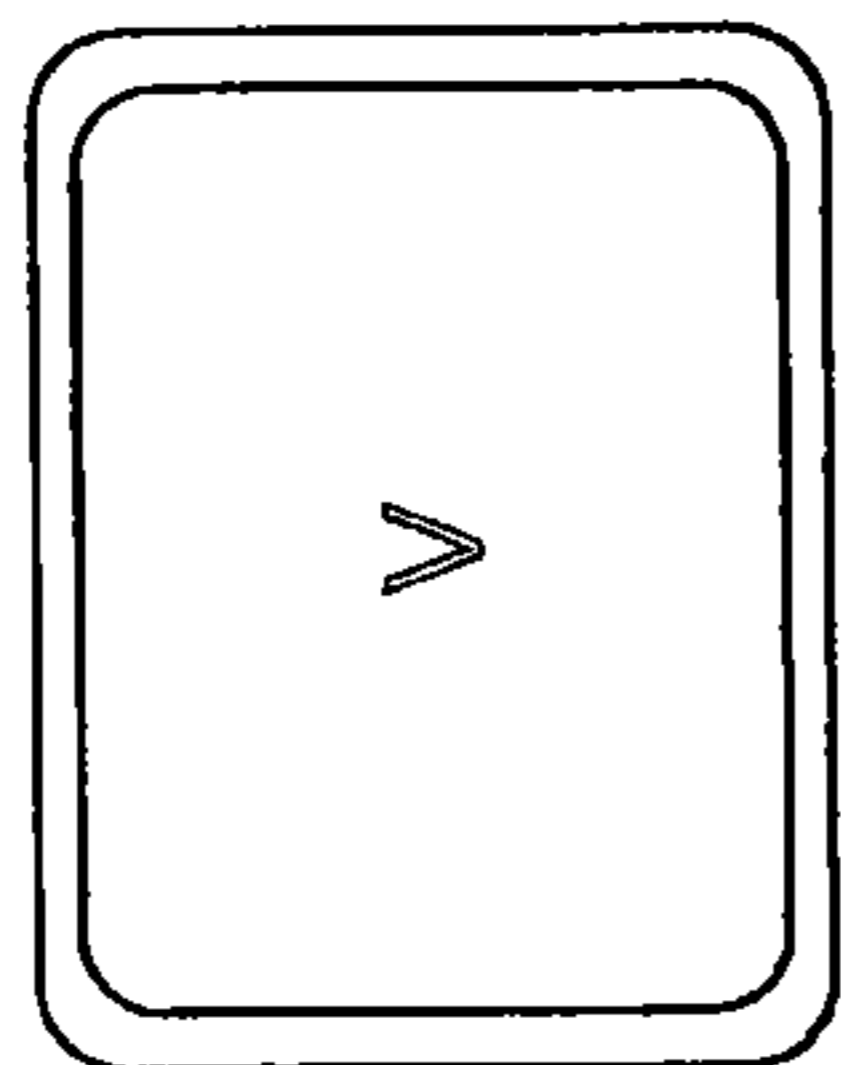

Fig. 244

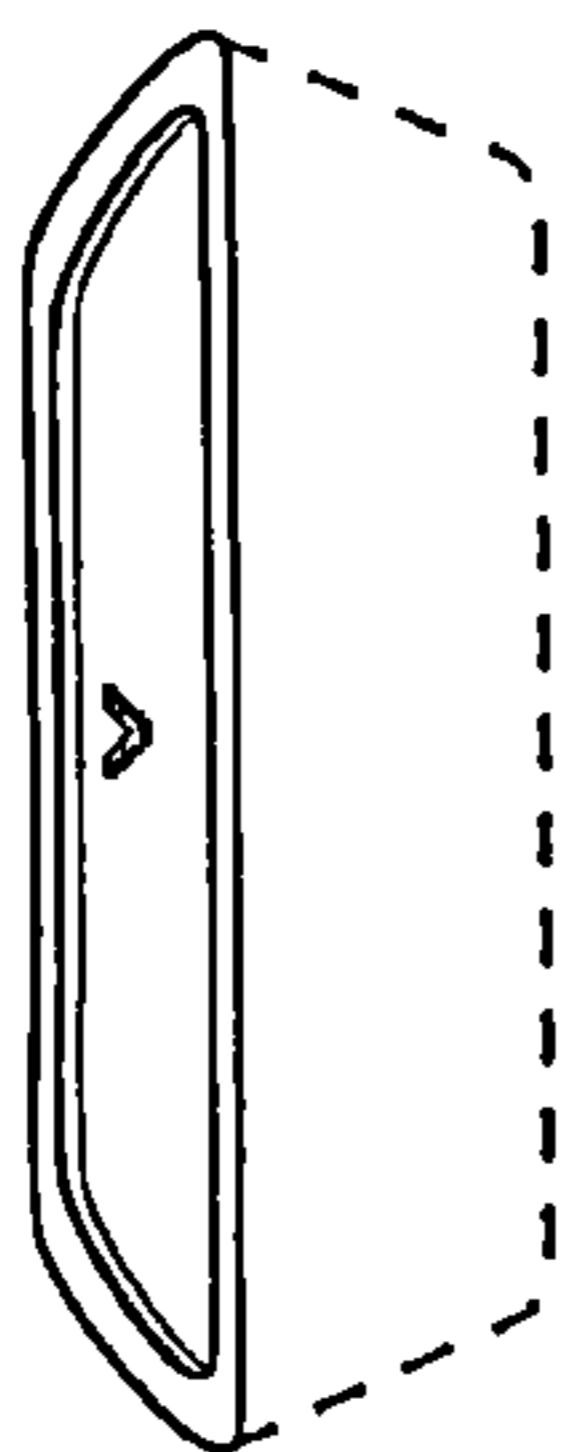

Fig. 243

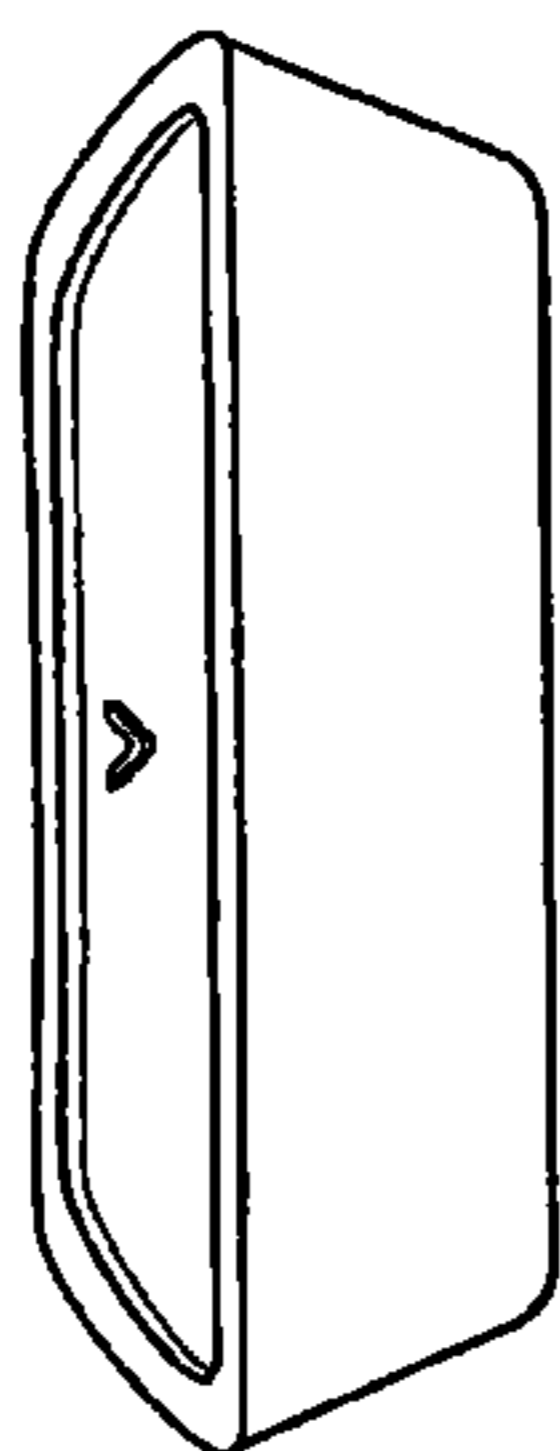

Fig. 242

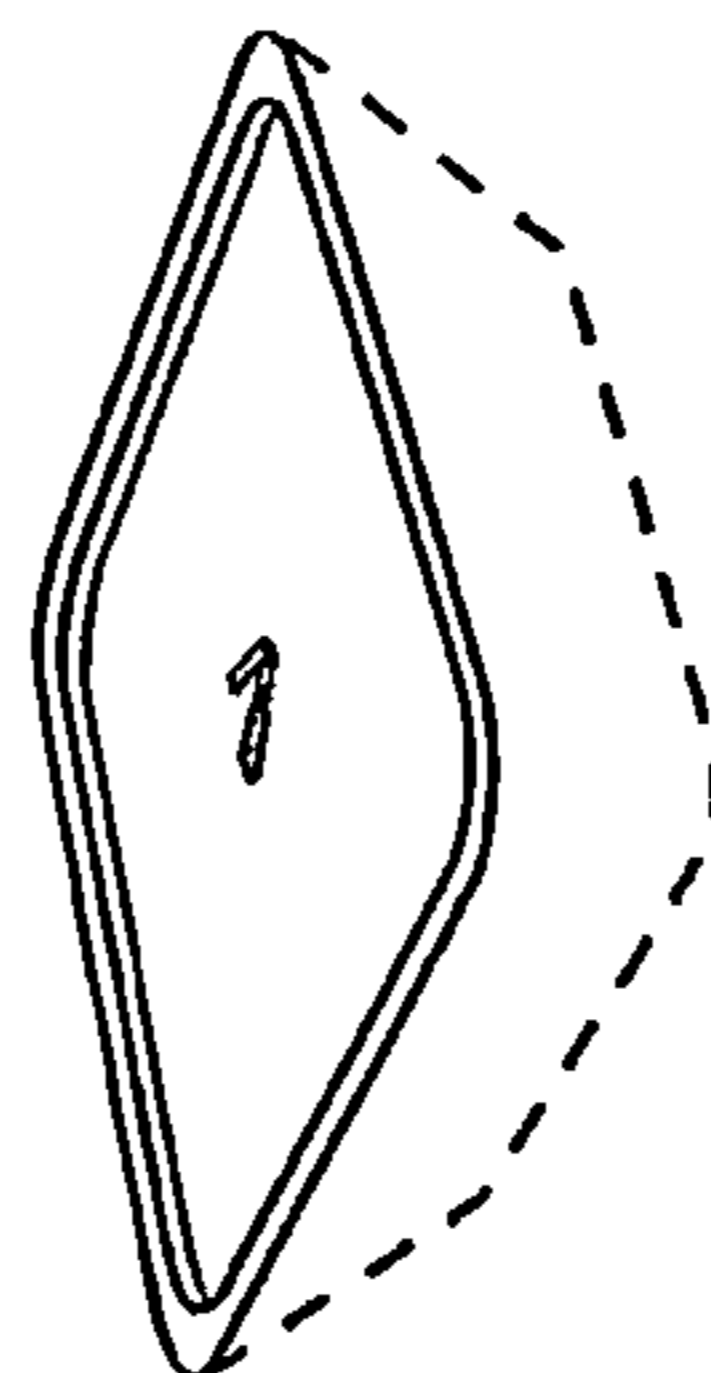

Fig. 246

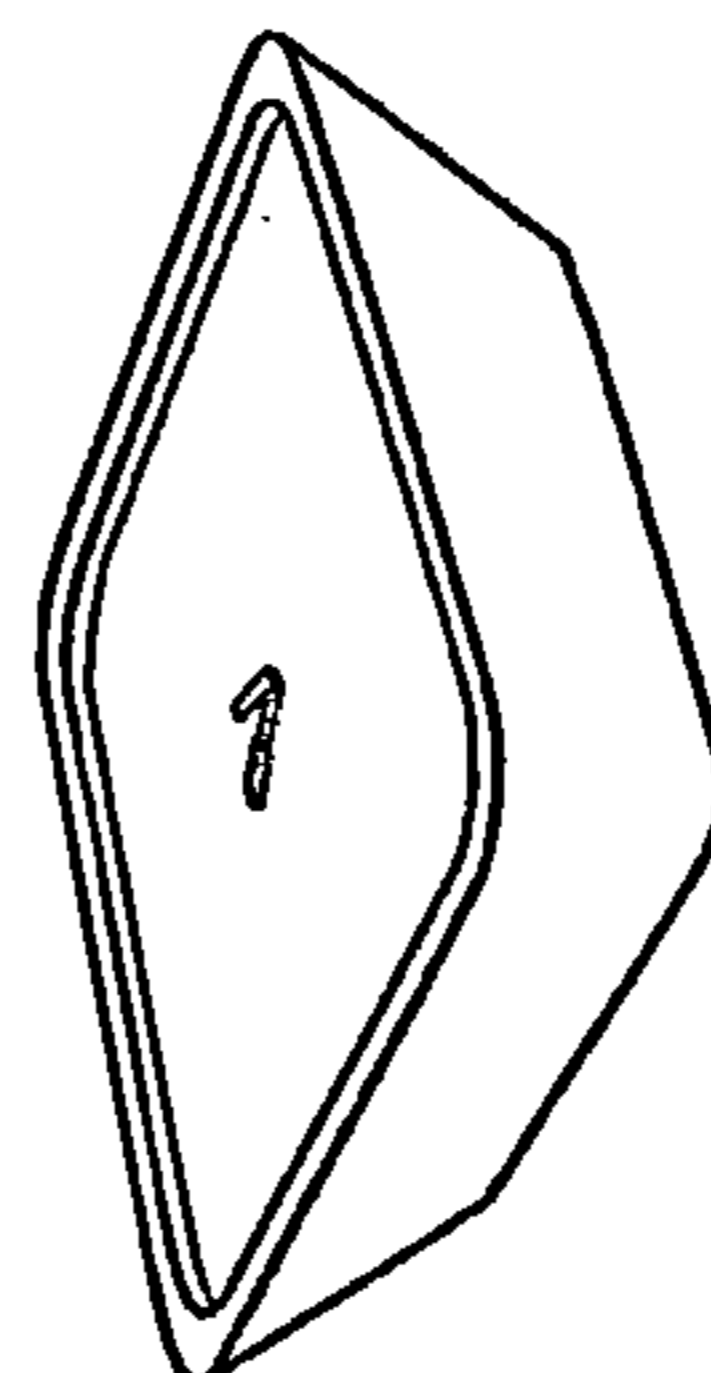

Fig. 245

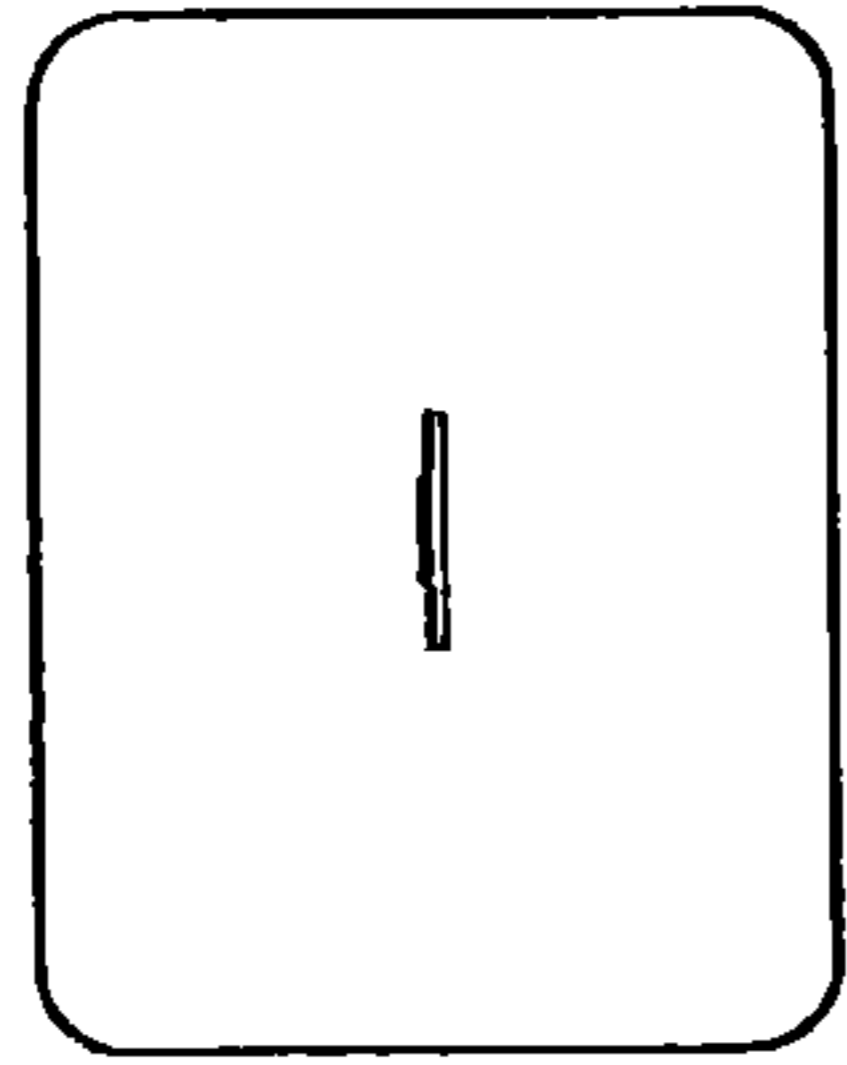

Fig. 249

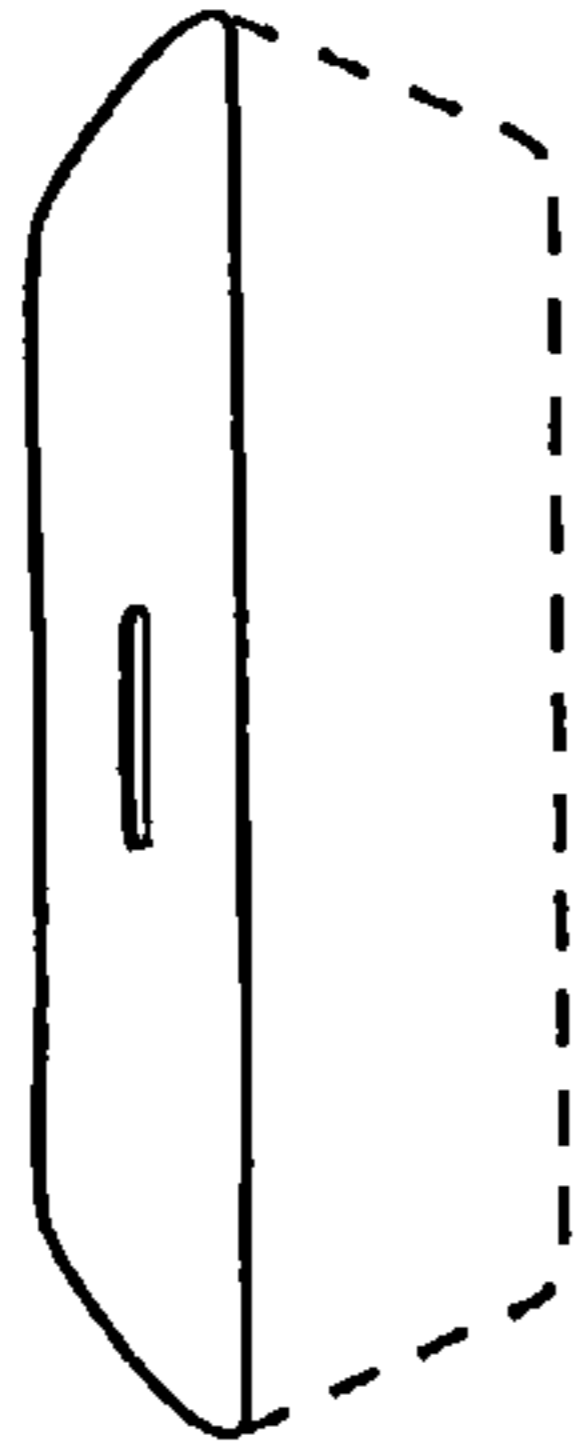

Fig. 248

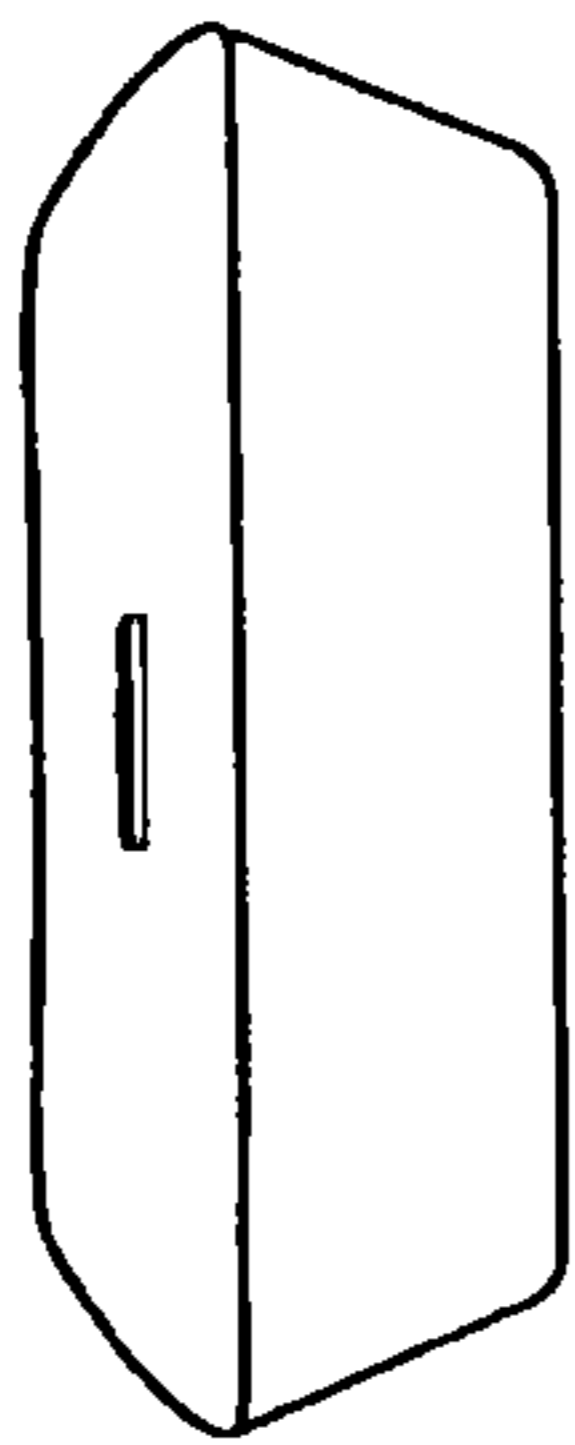

Fig. 247

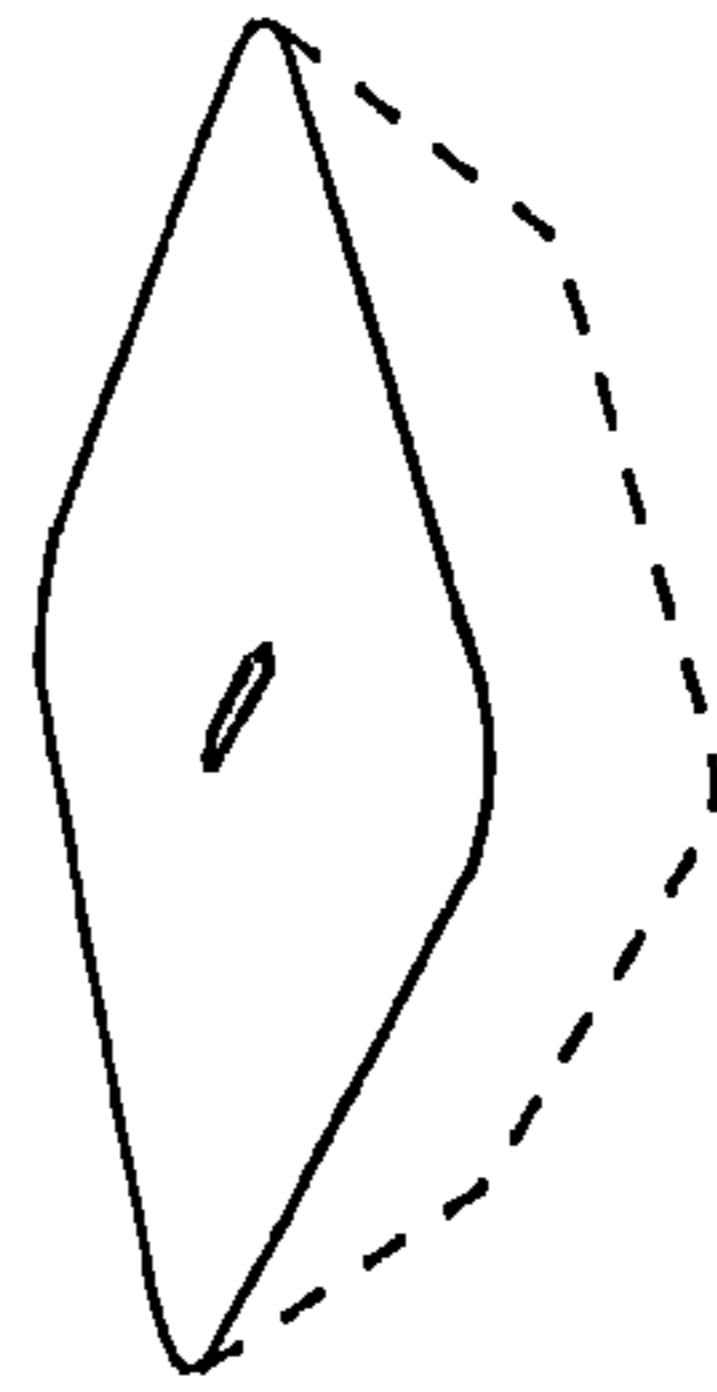

Fig. 251

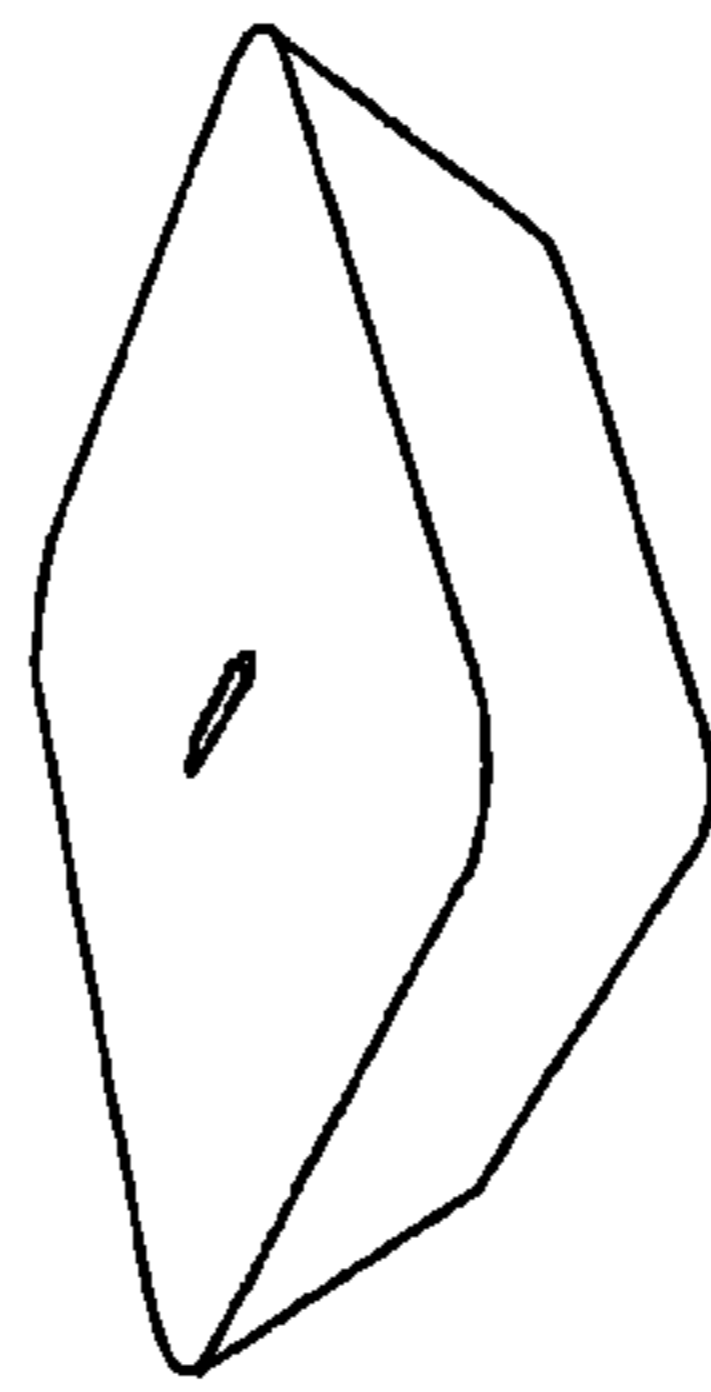

Fig. 250

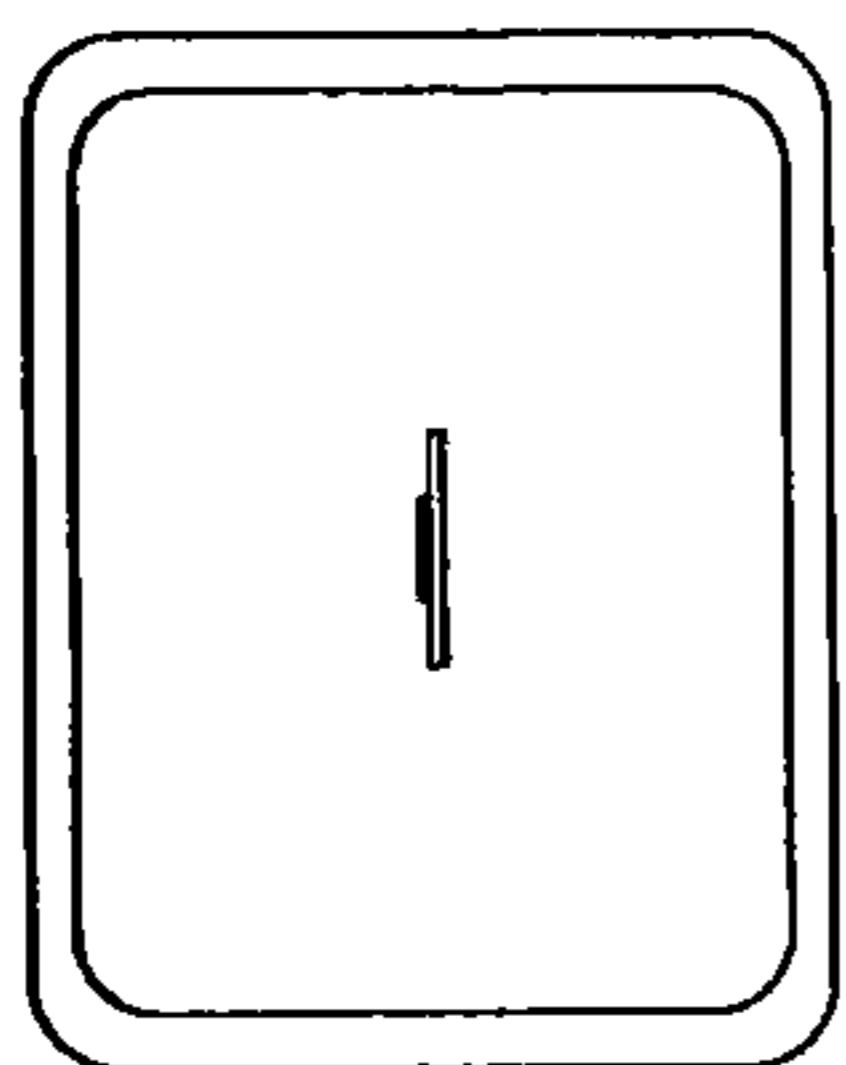

Fig. 254

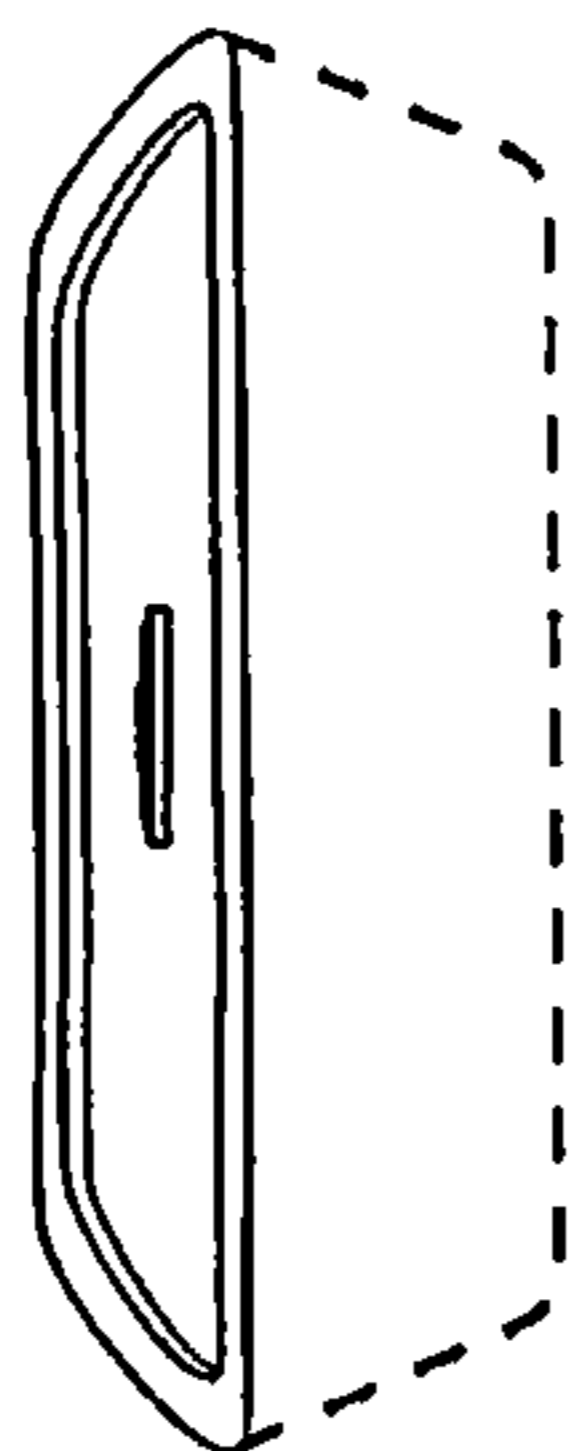

Fig. 253

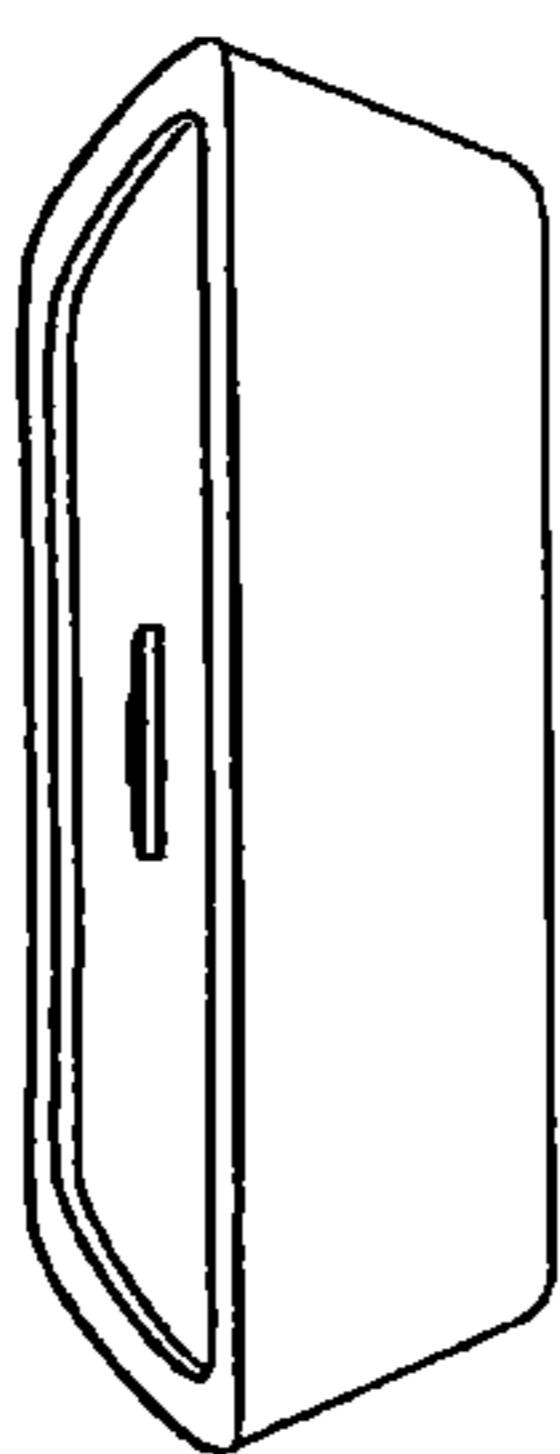

Fig. 252

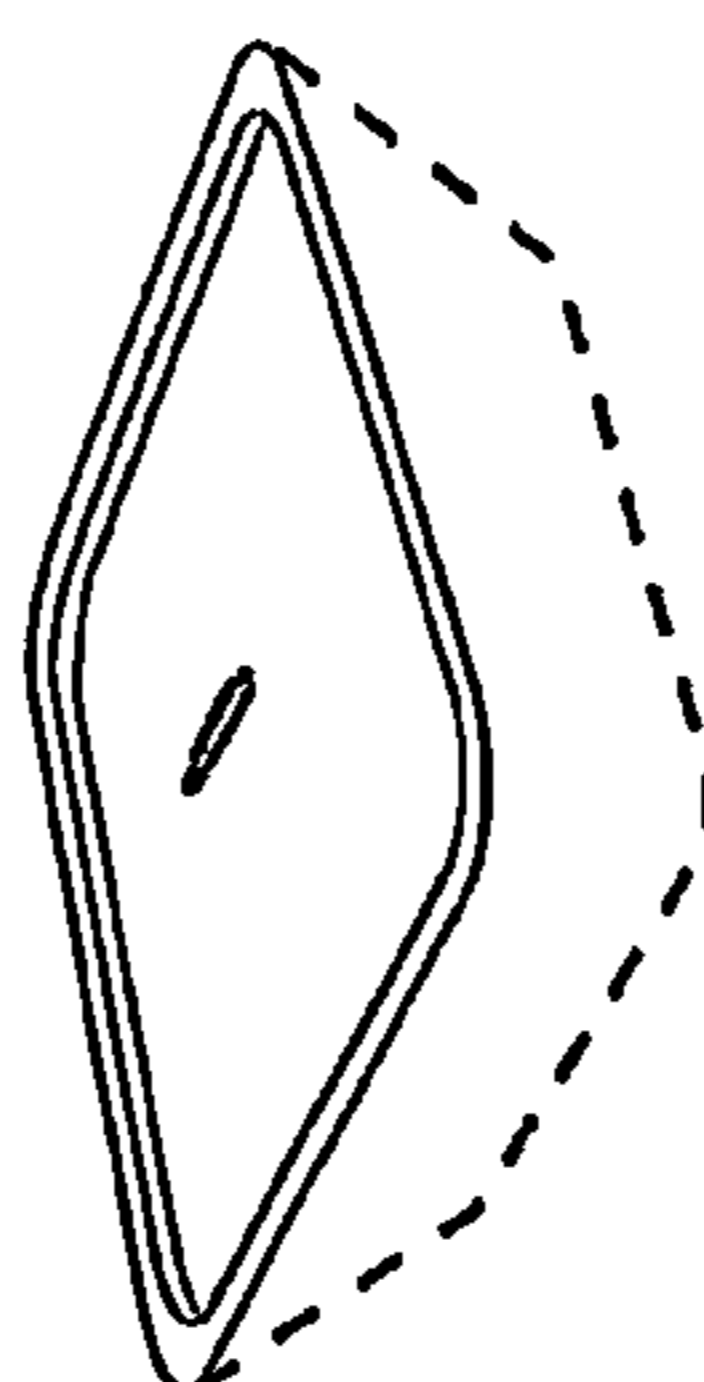

Fig. 256

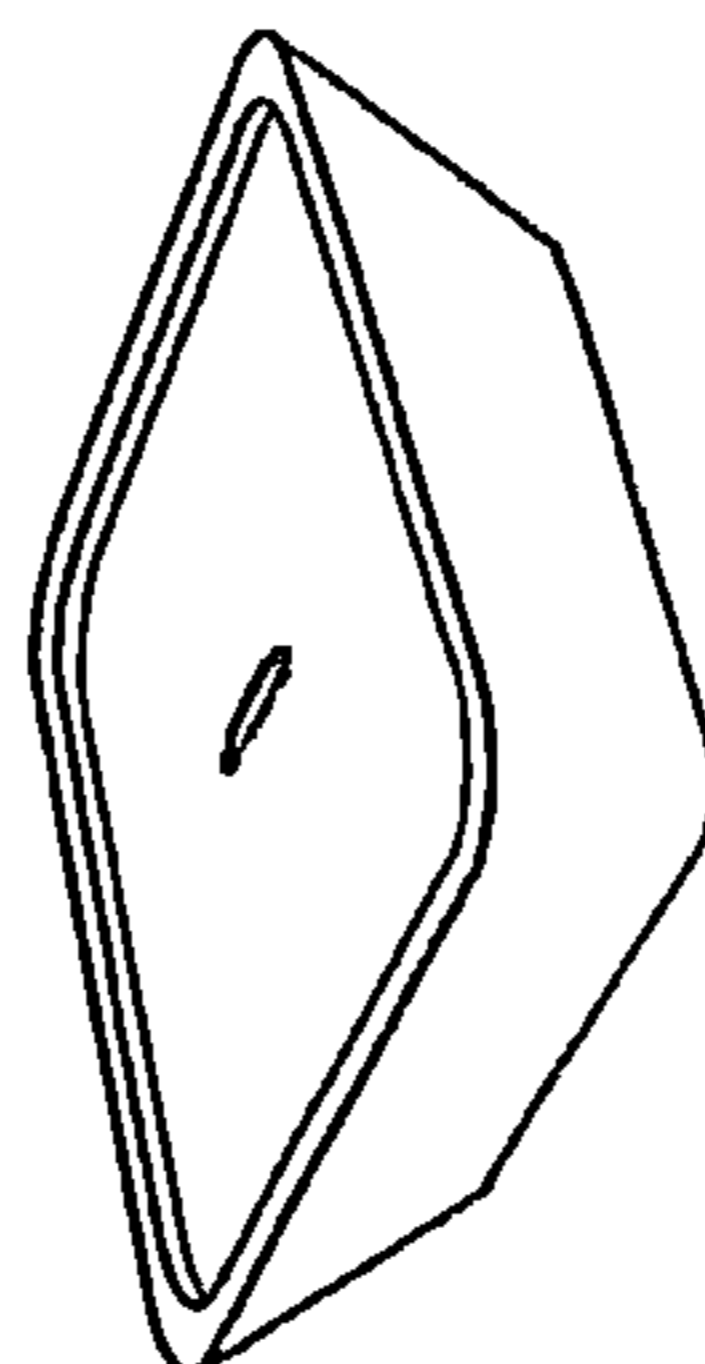

Fig. 255

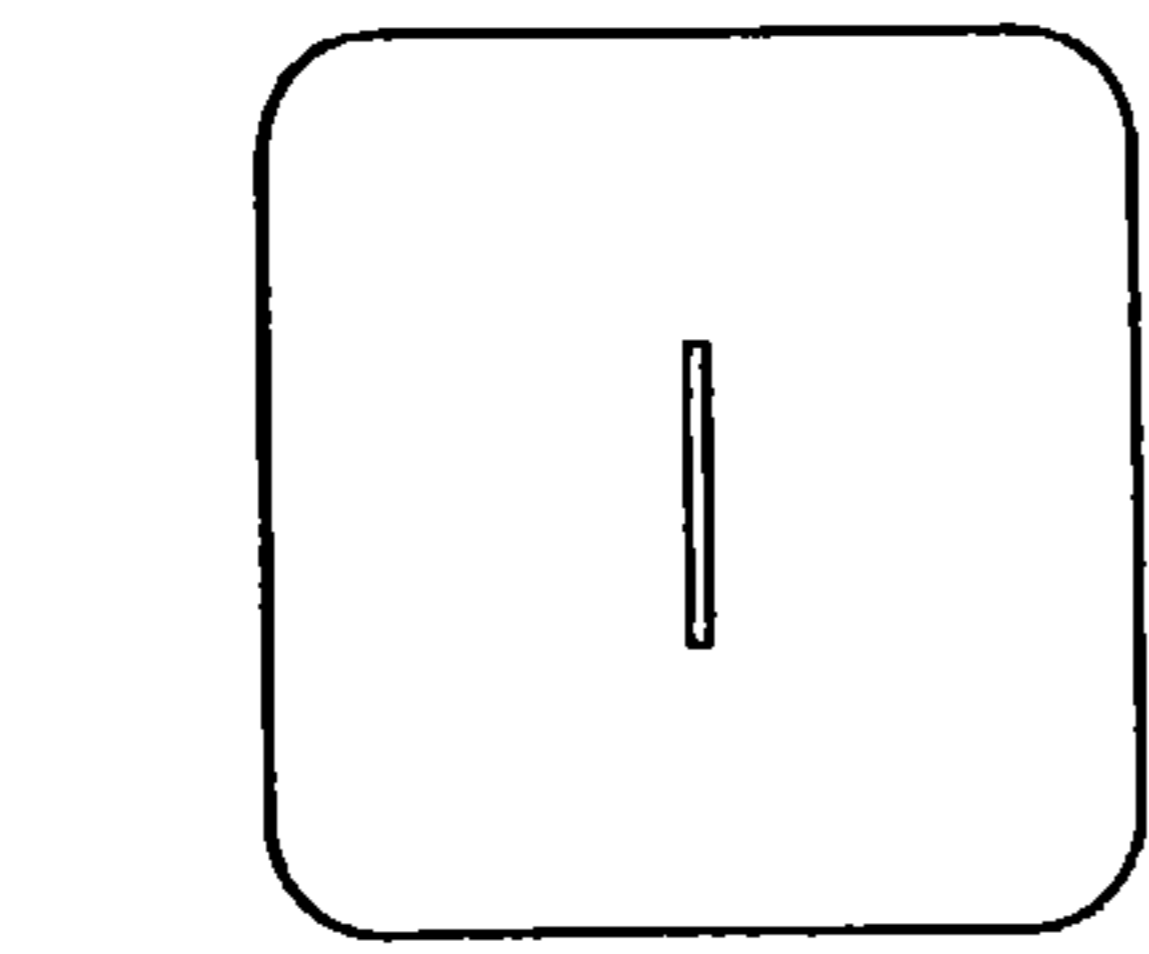

Fig. 259

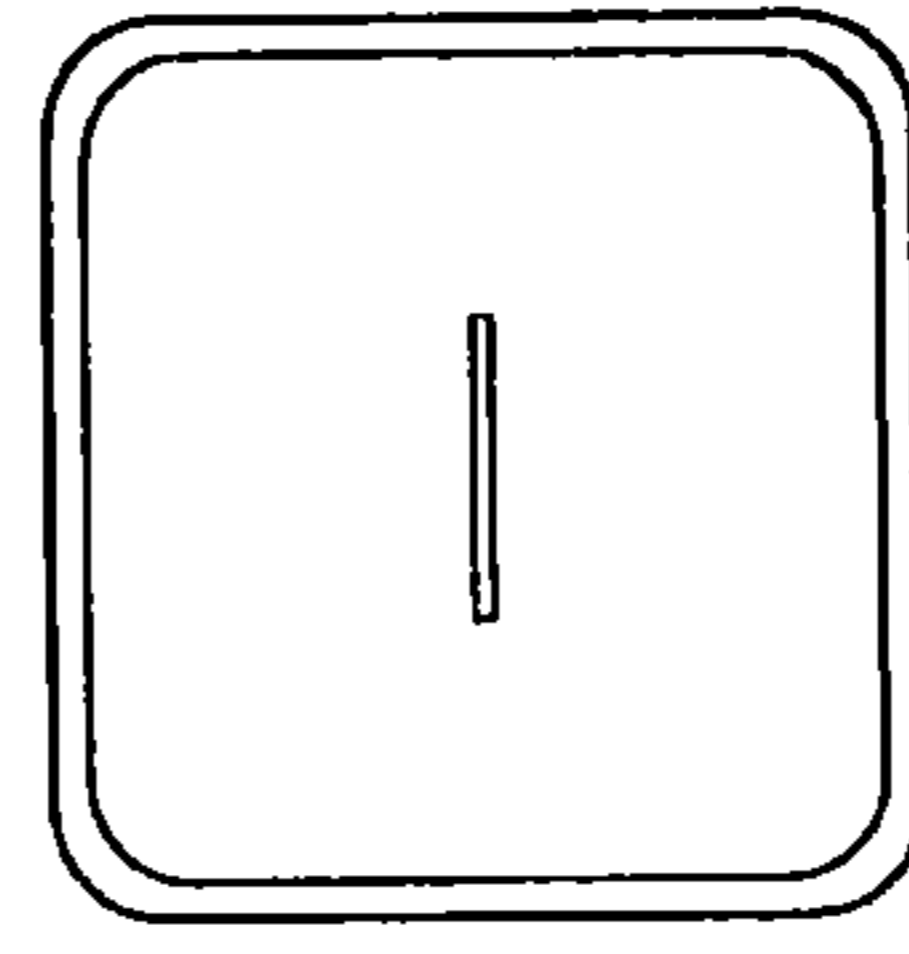

Fig. 262

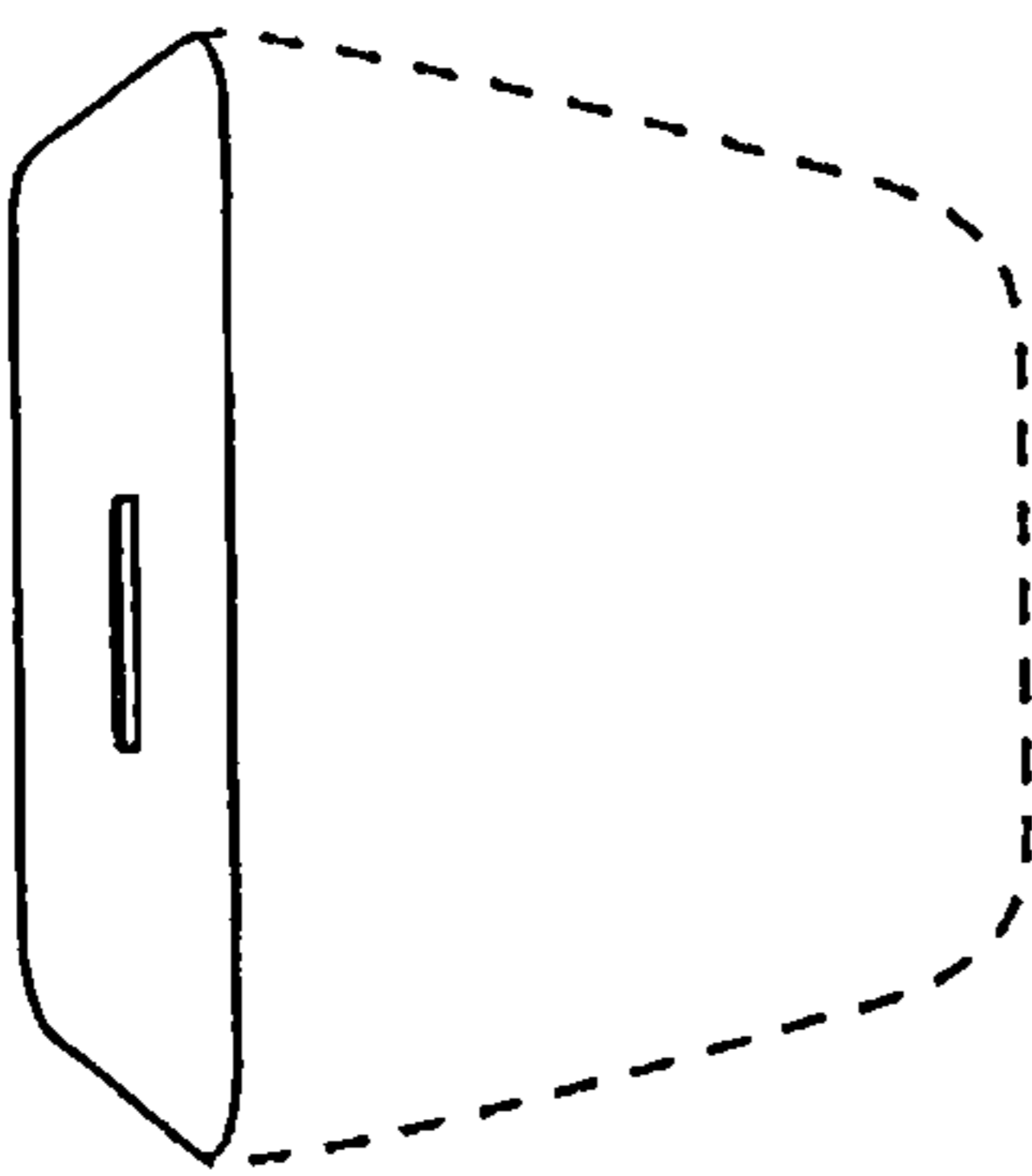

Fig. 258

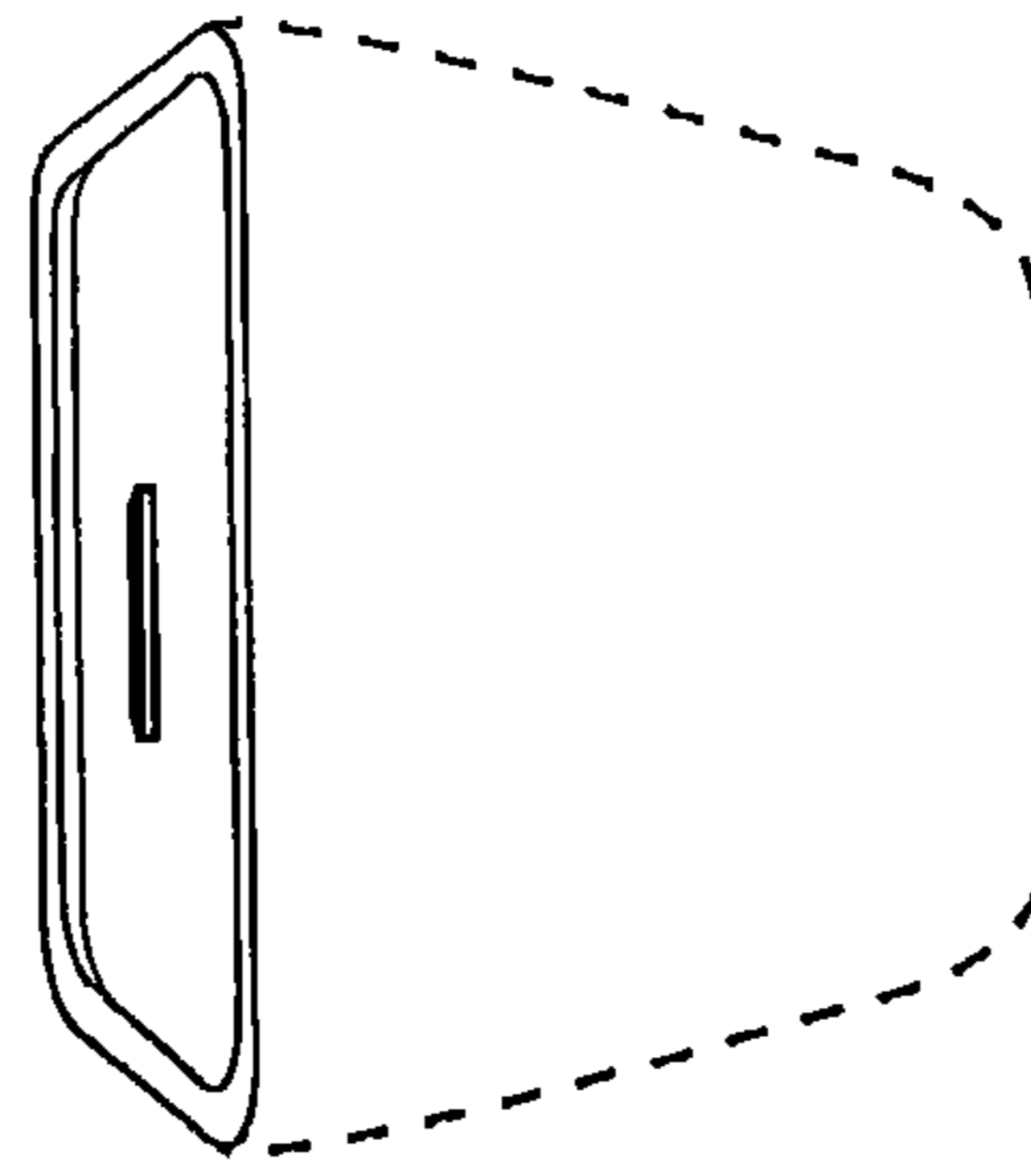

Fig. 261

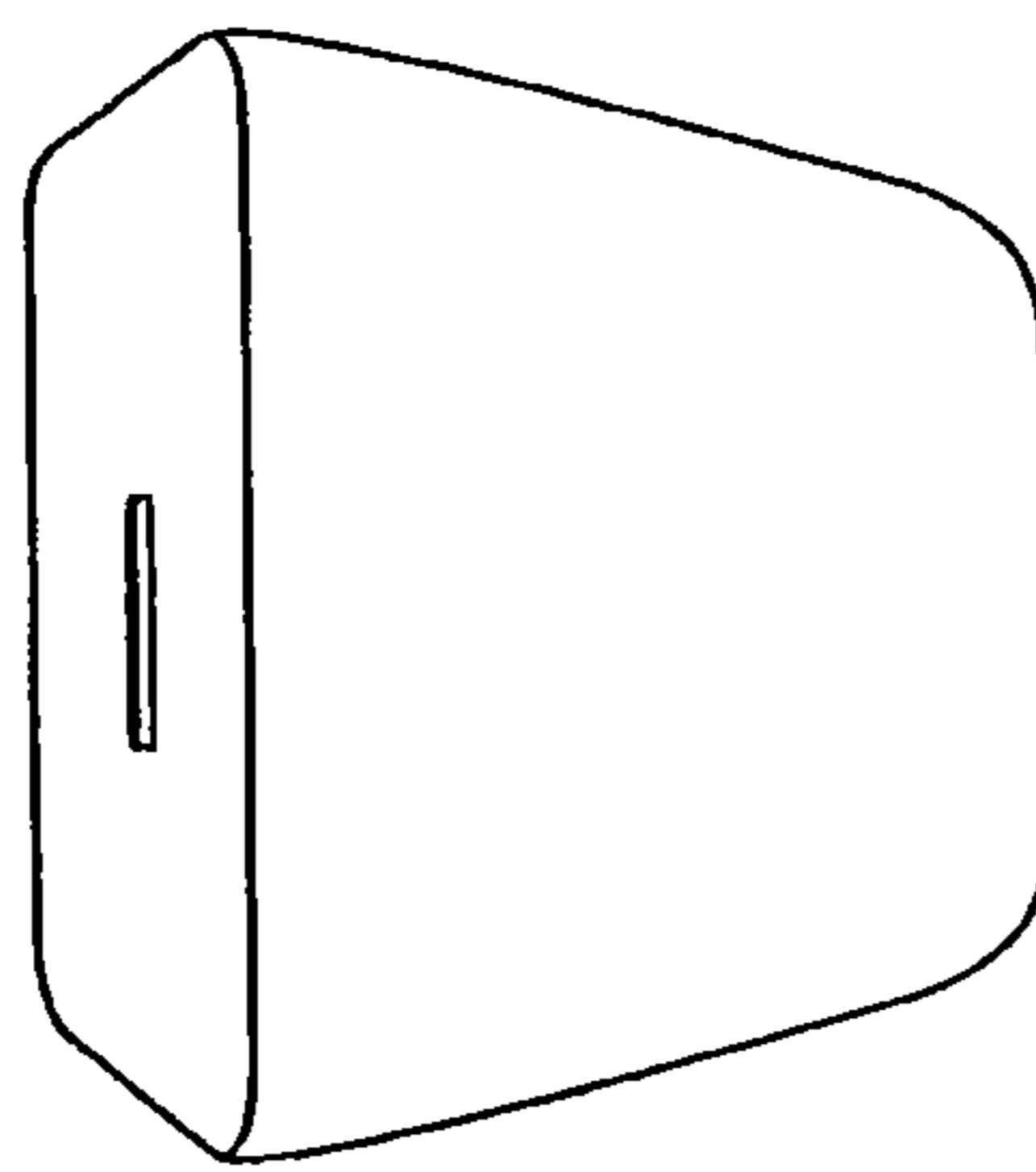

Fig. 257

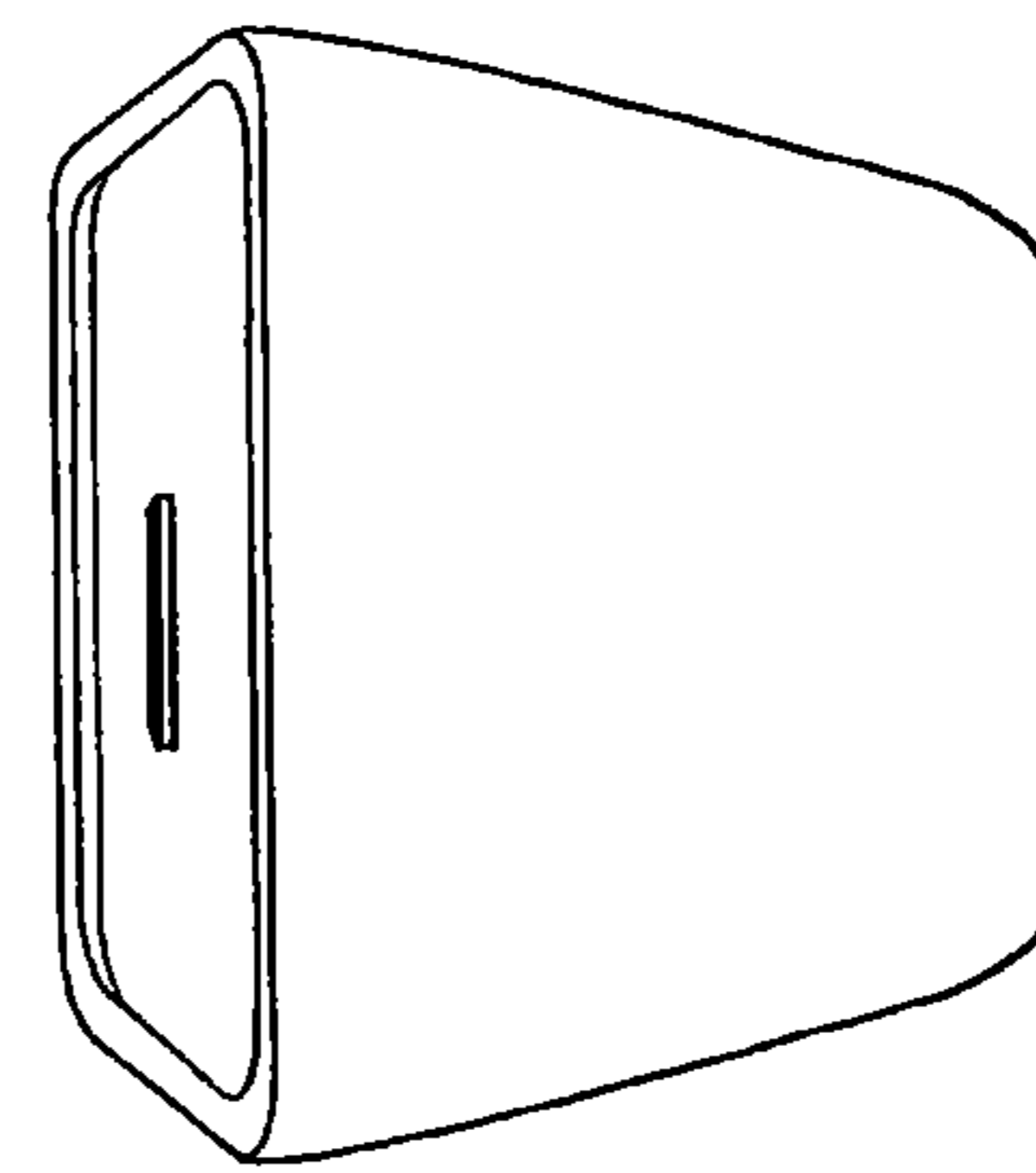

Fig. 260

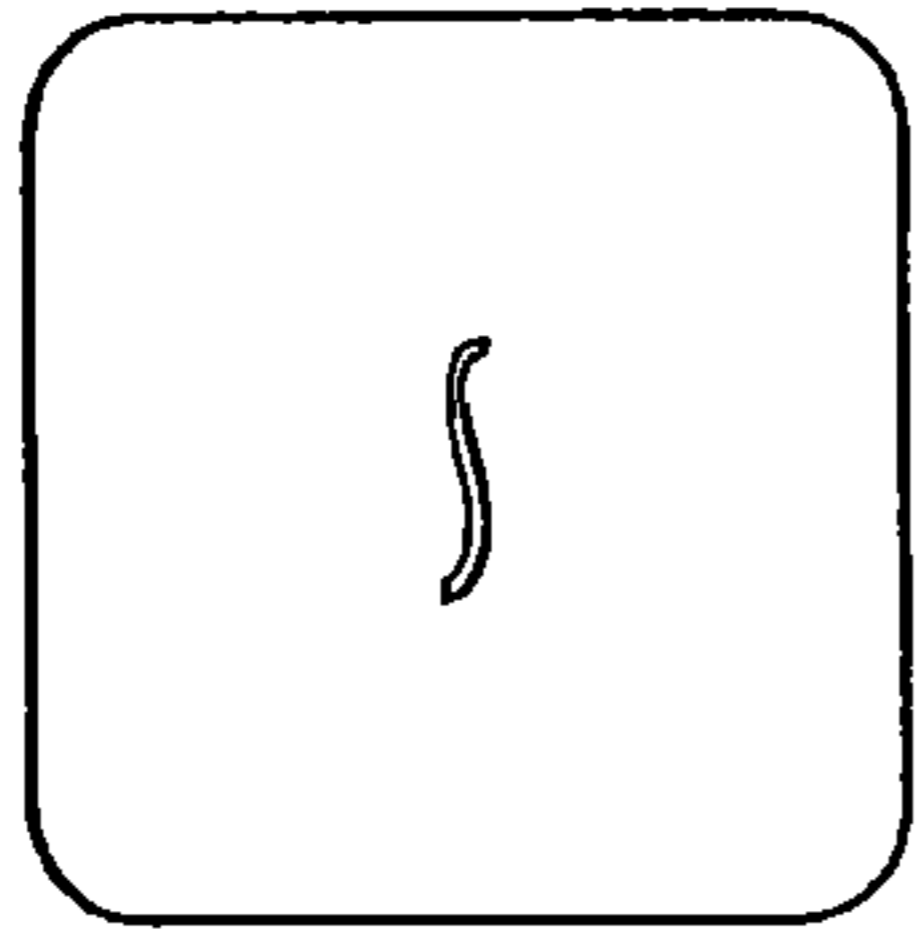

Fig. 265

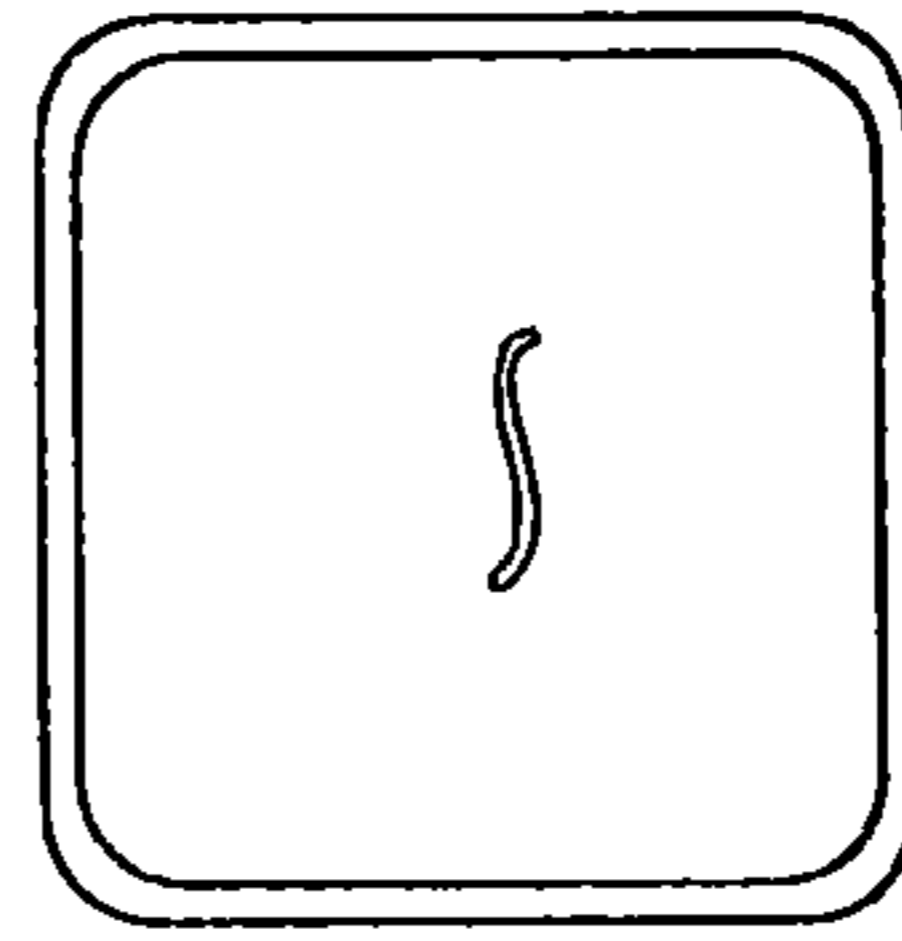

Fig. 268

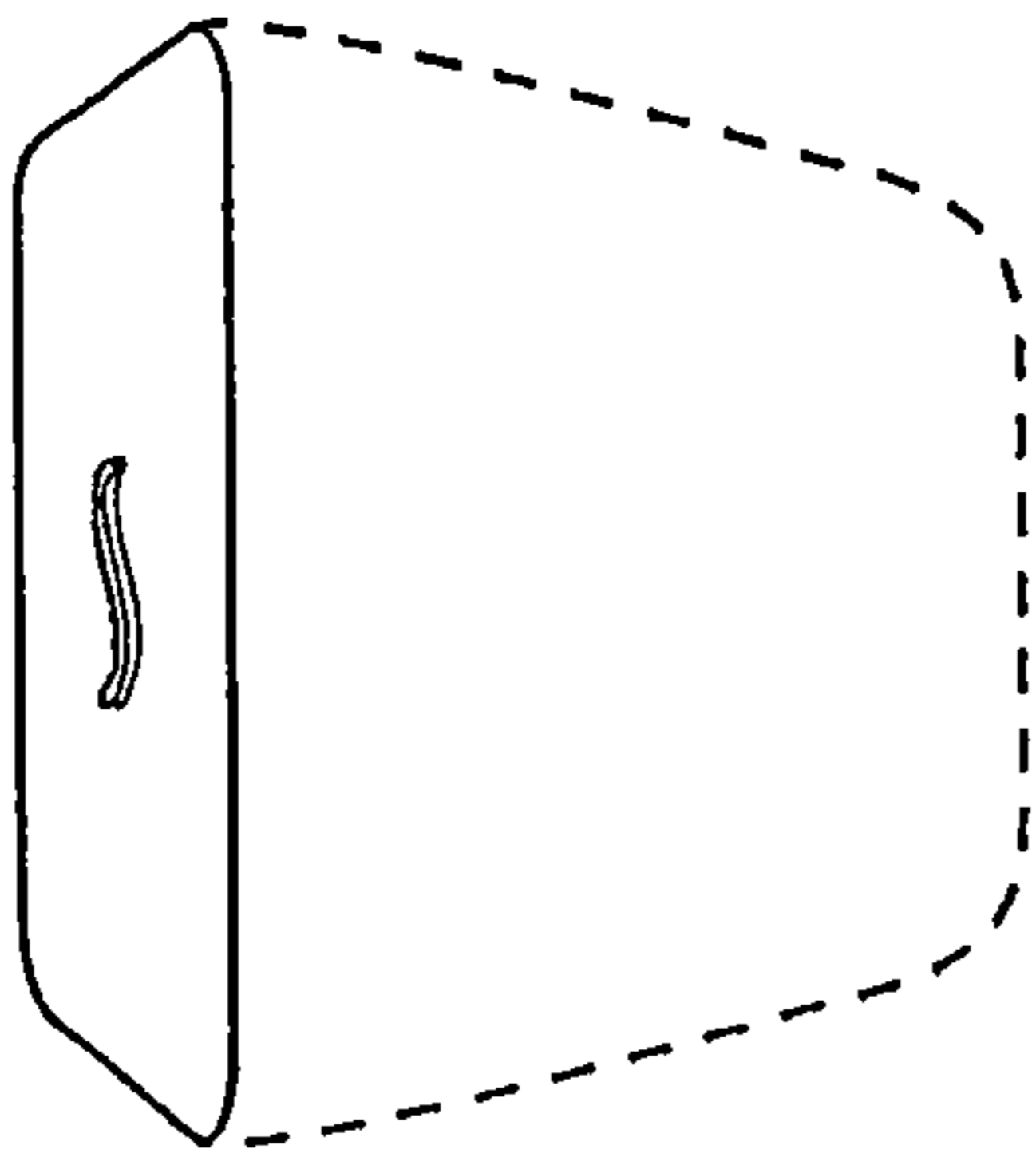

Fig. 264

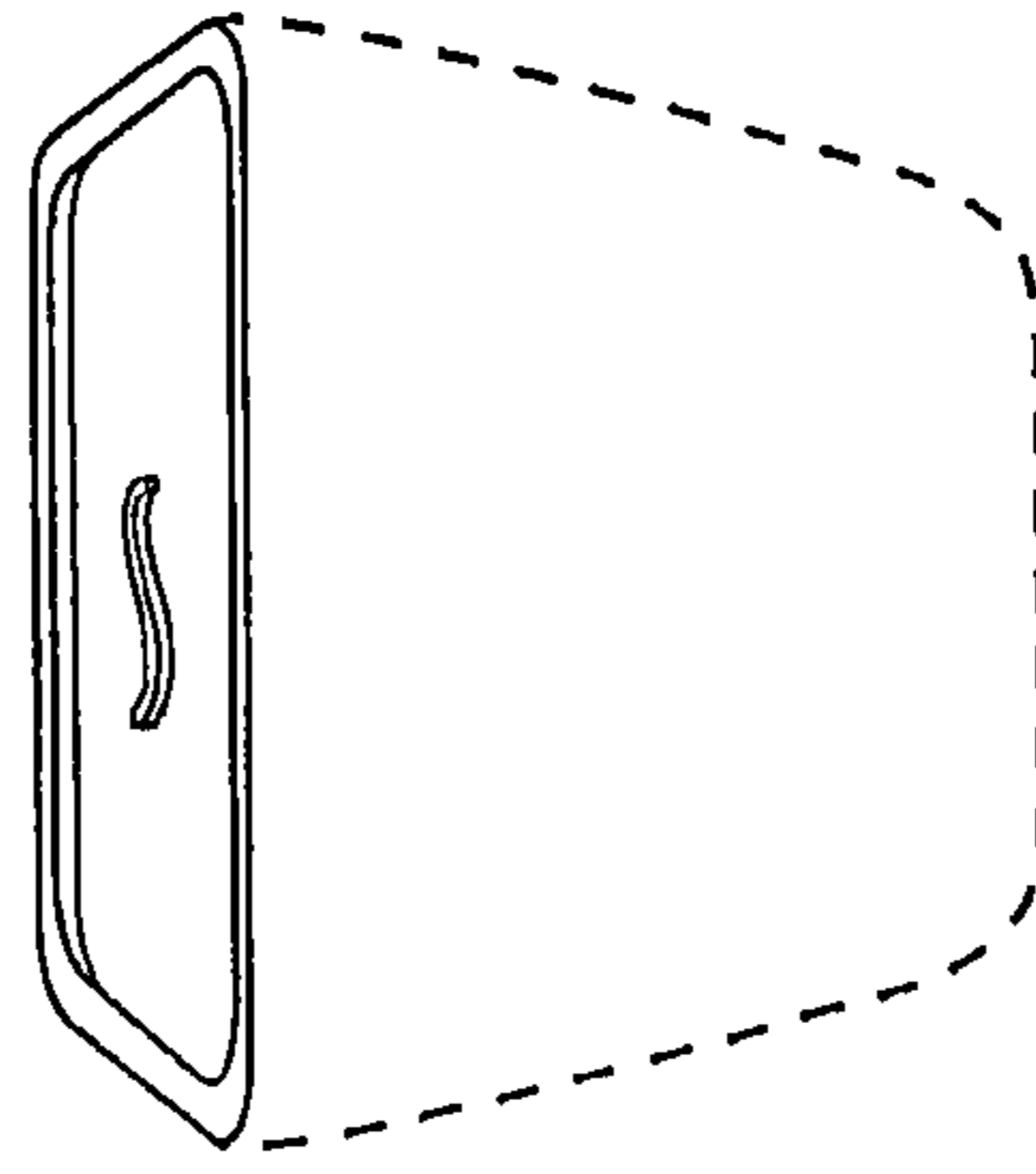

Fig. 267

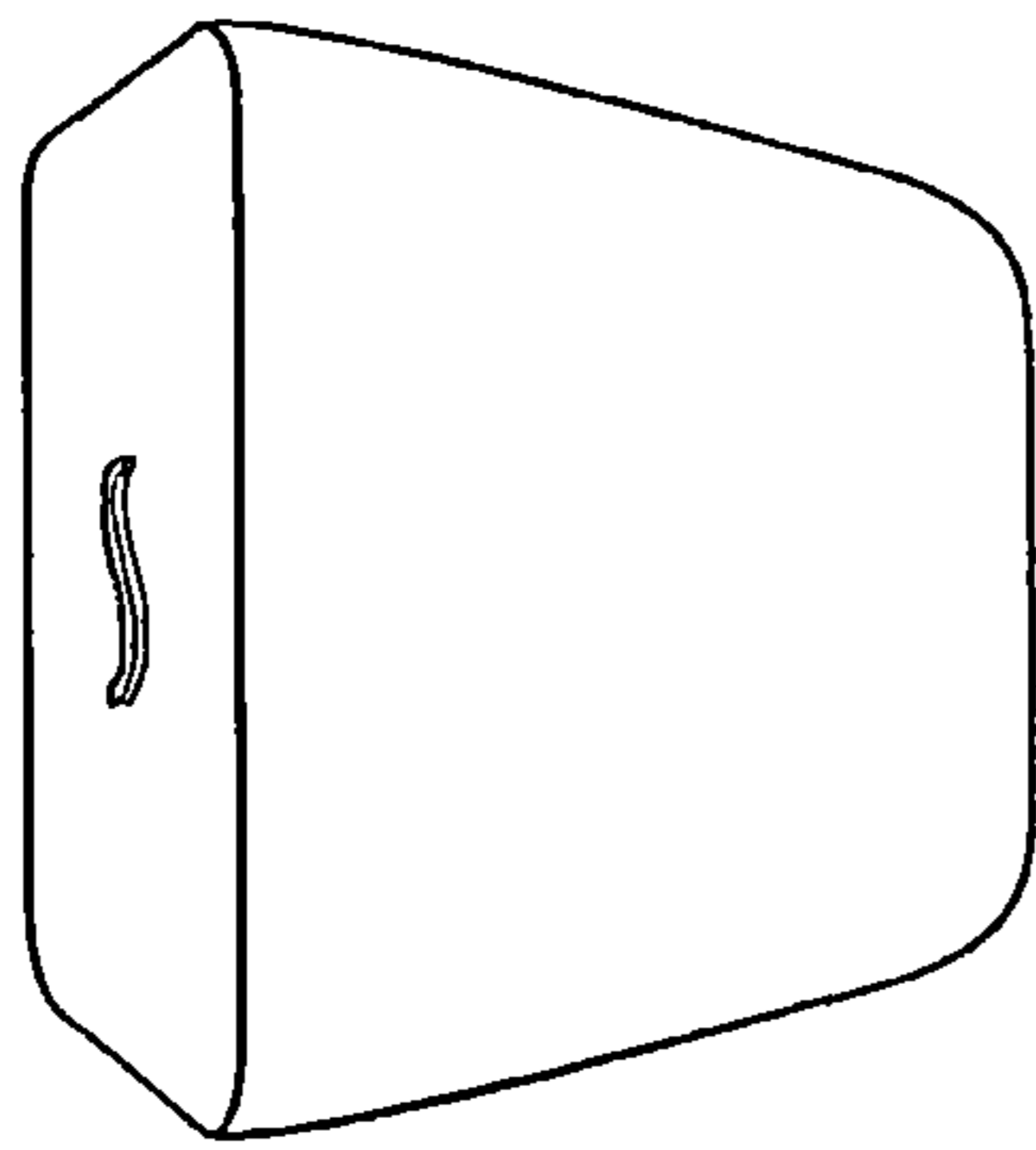

Fig. 263

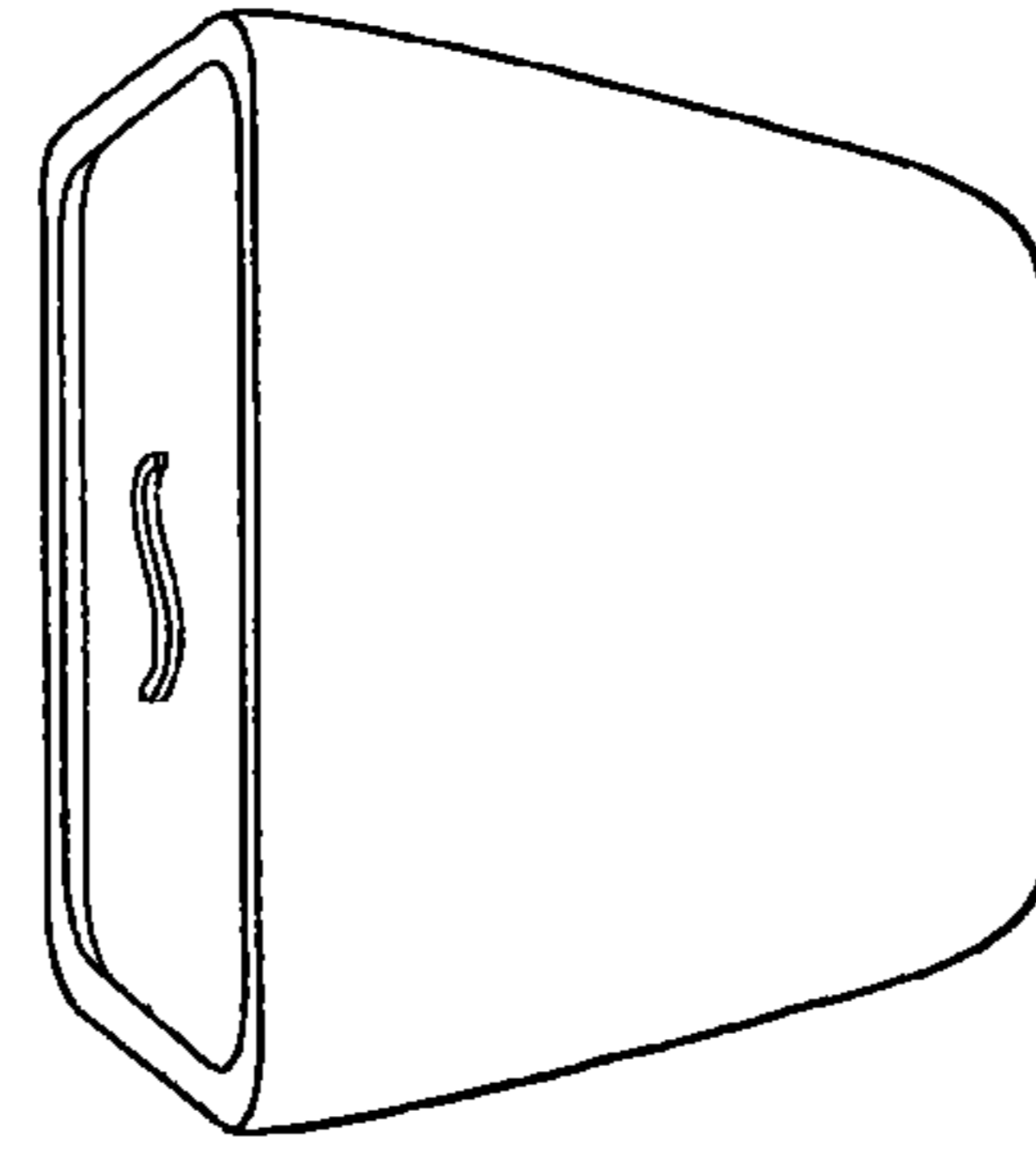

Fig. 266

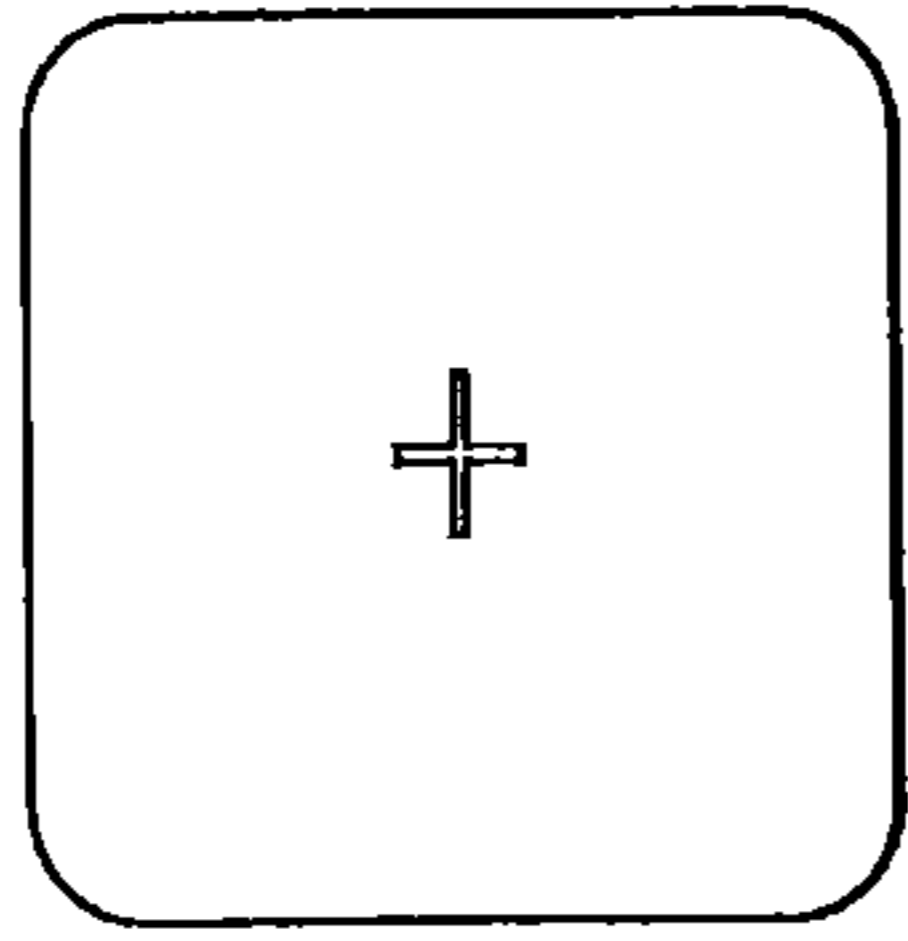

Fig. 271

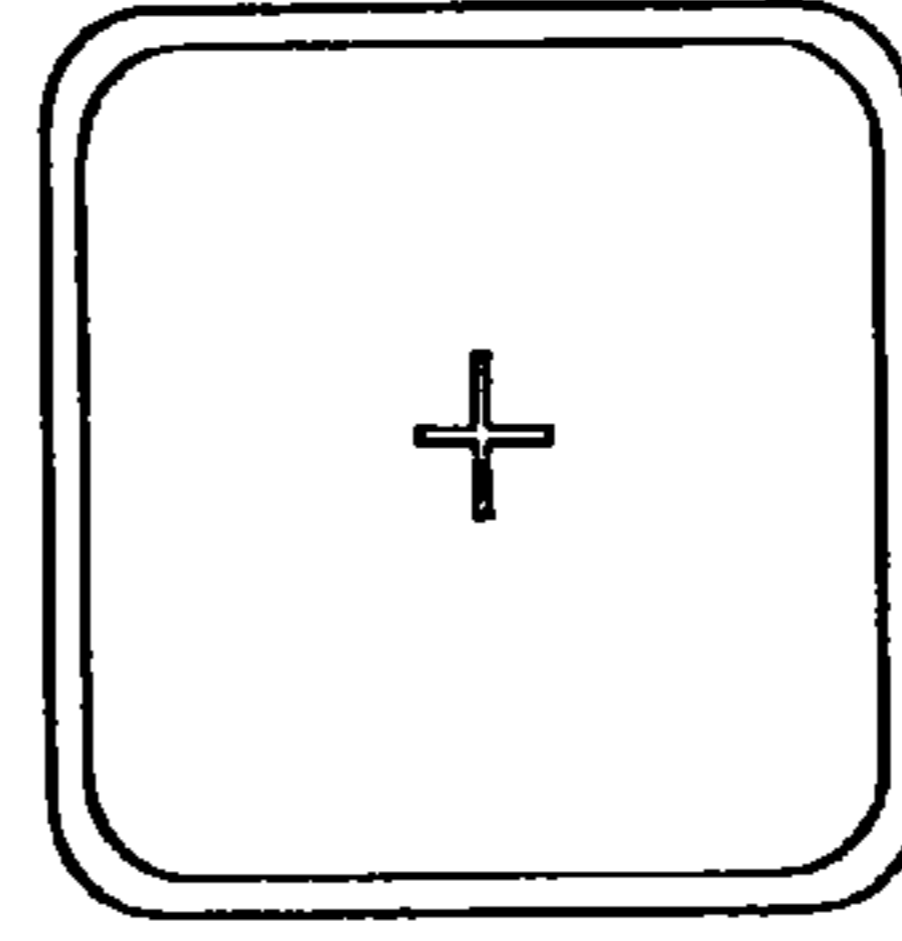

Fig. 274

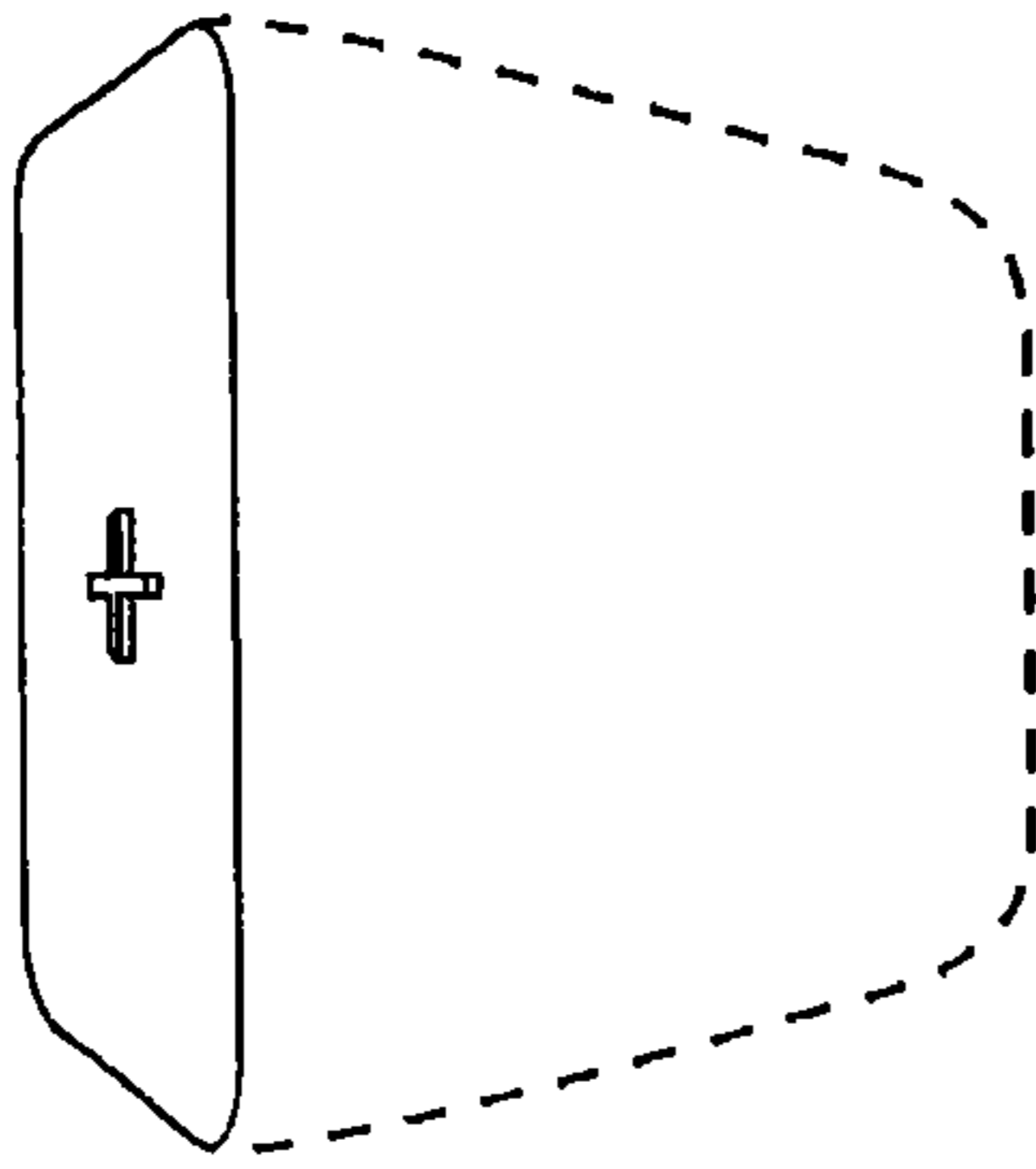

Fig. 270

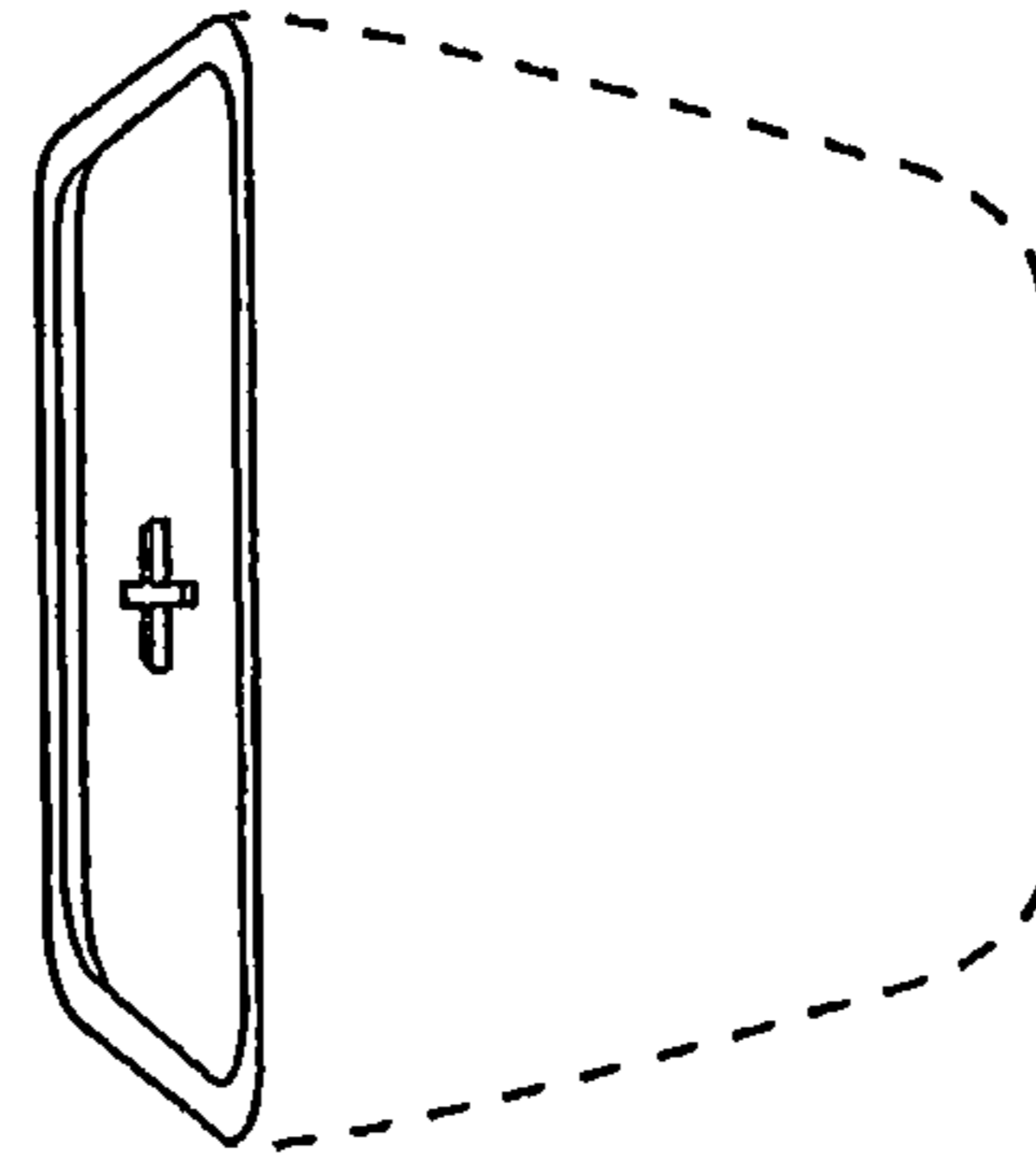

Fig. 273

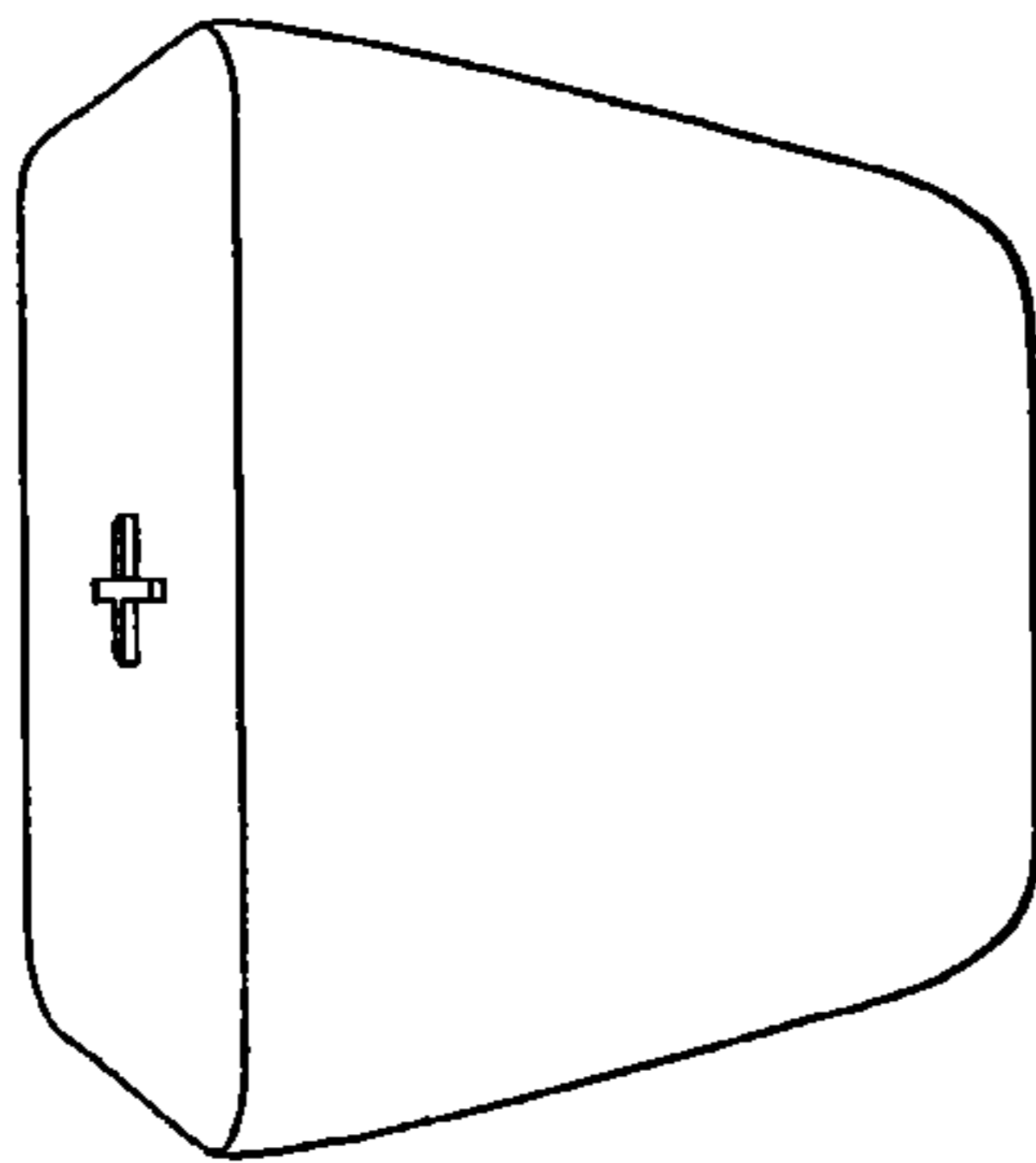

Fig. 269

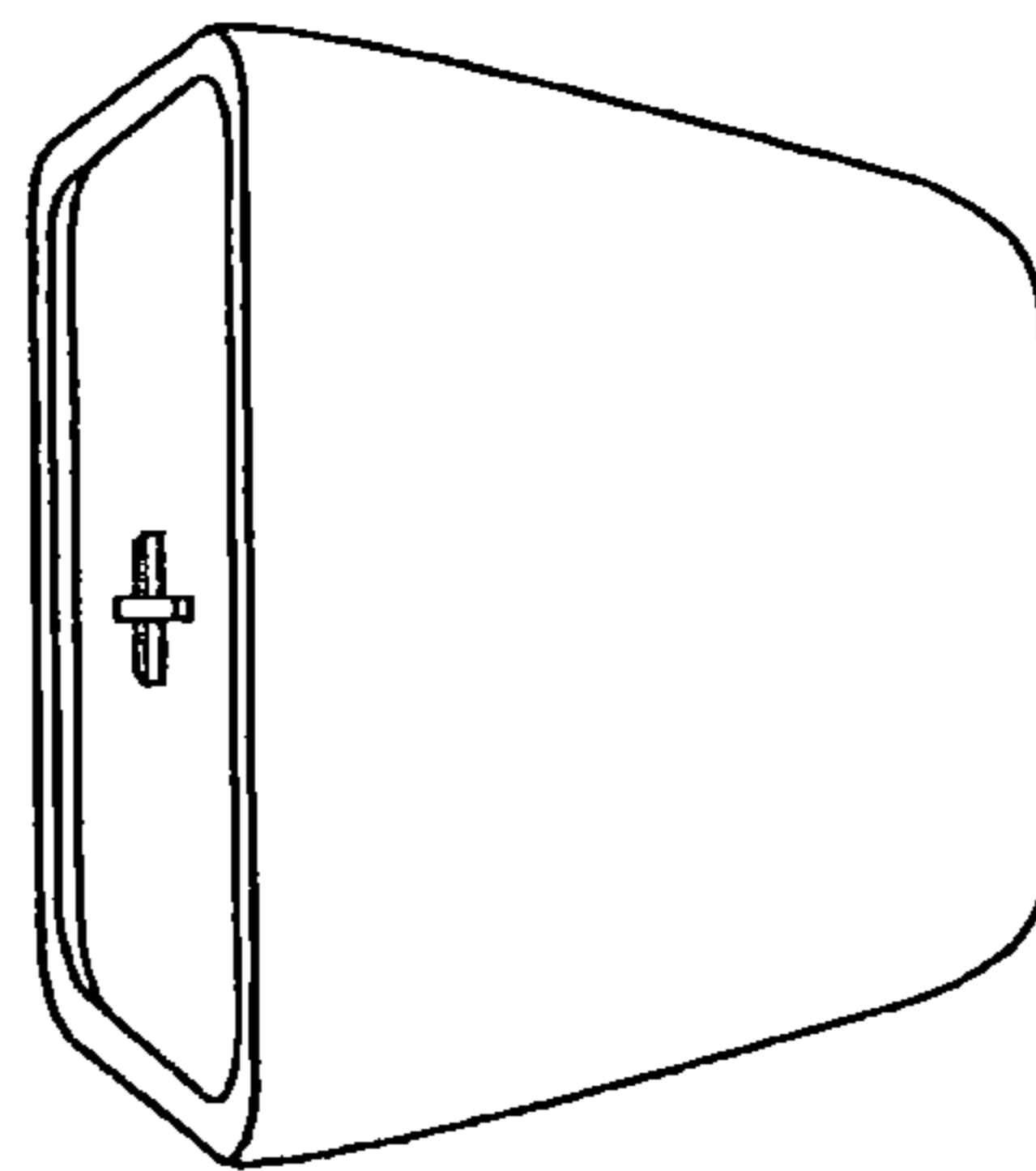

Fig. 272

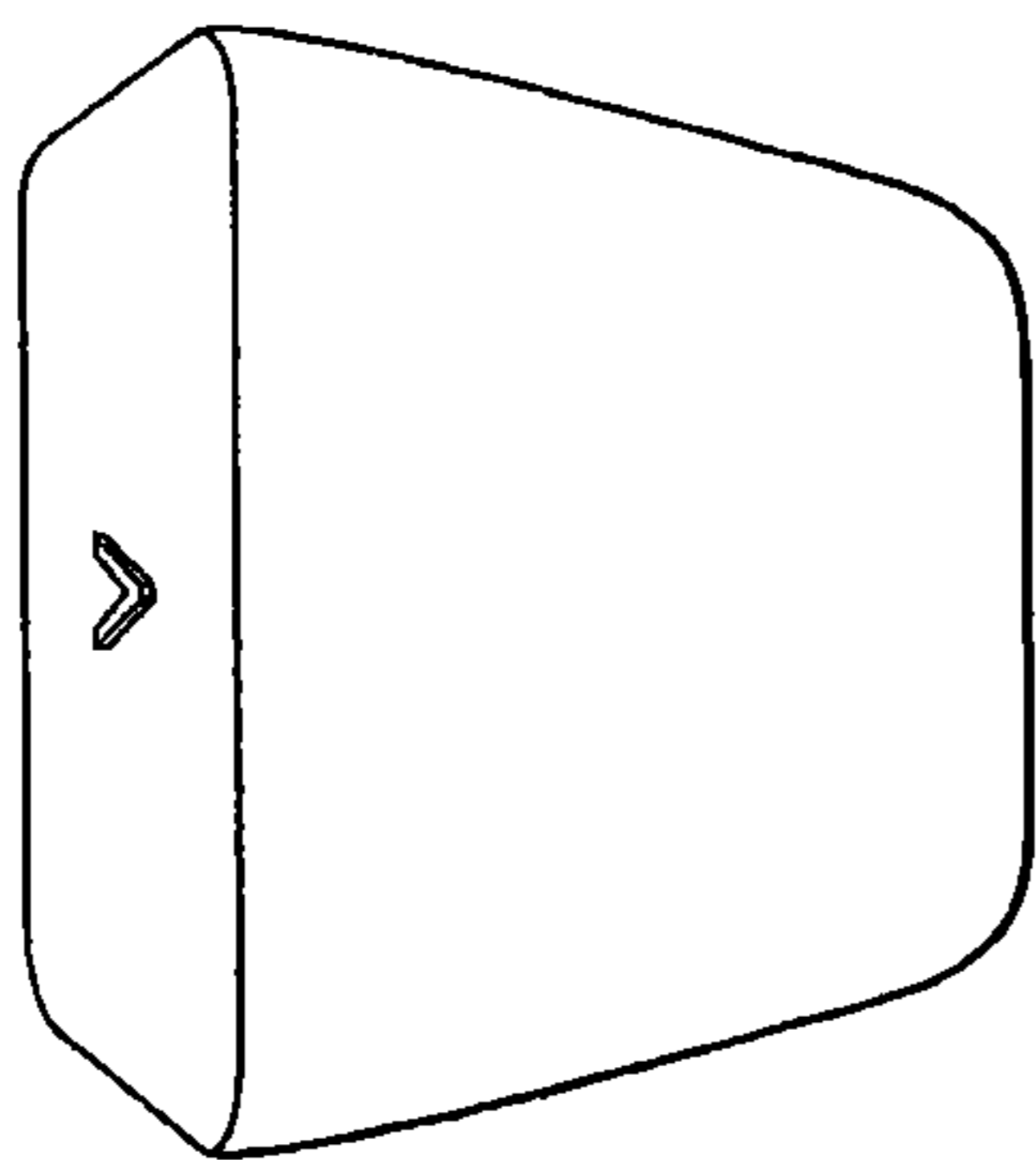

Fig. 275

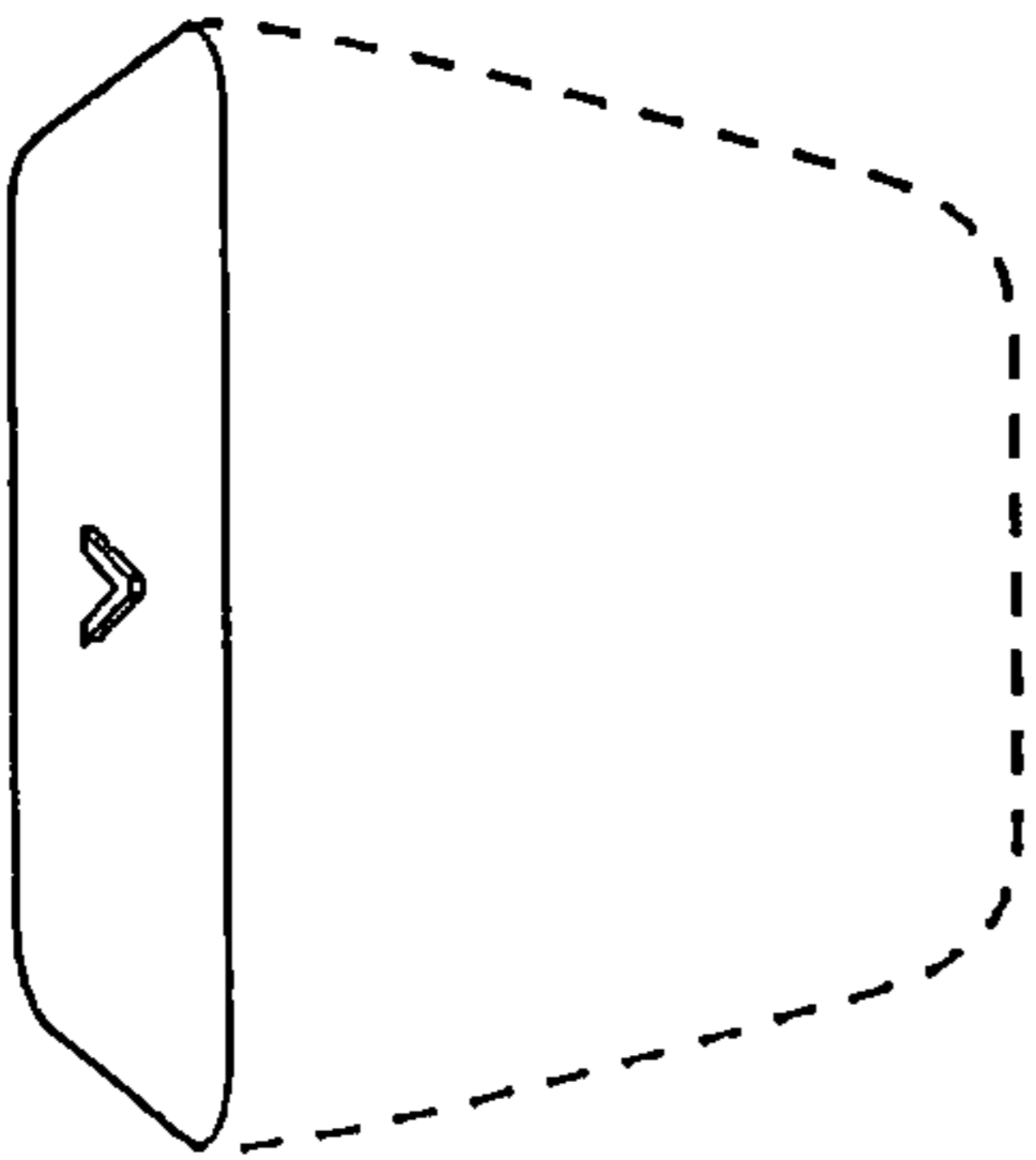

Fig. 276

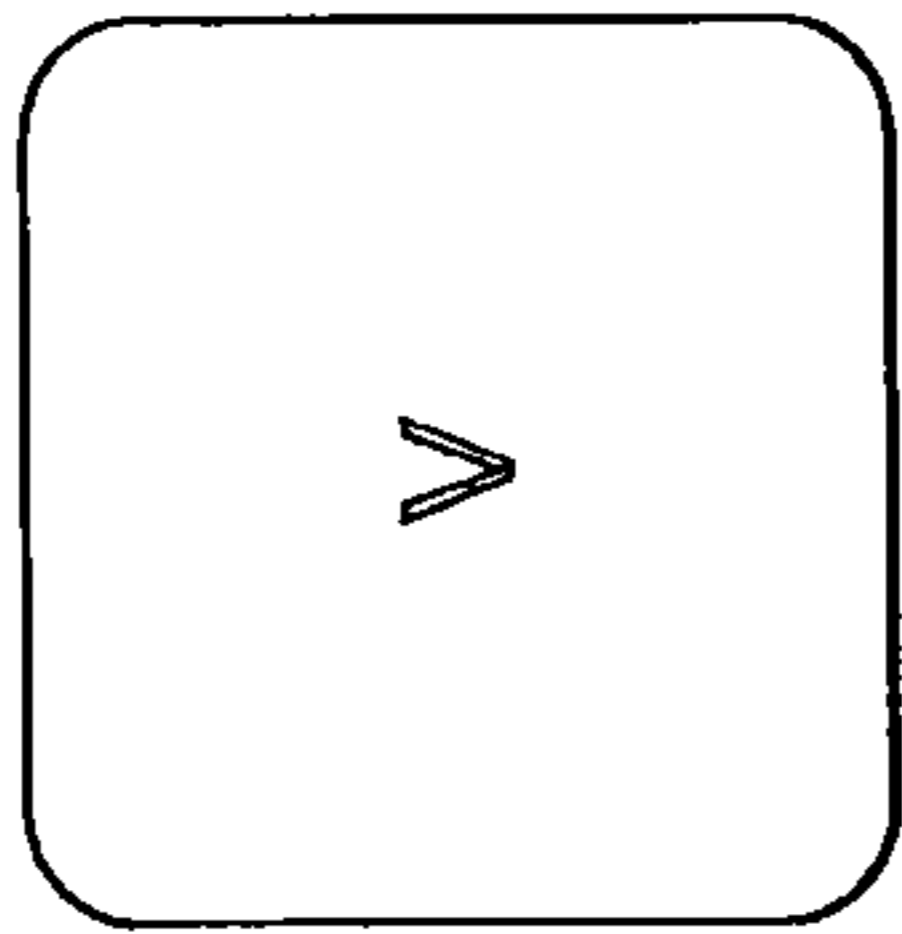

Fig. 277

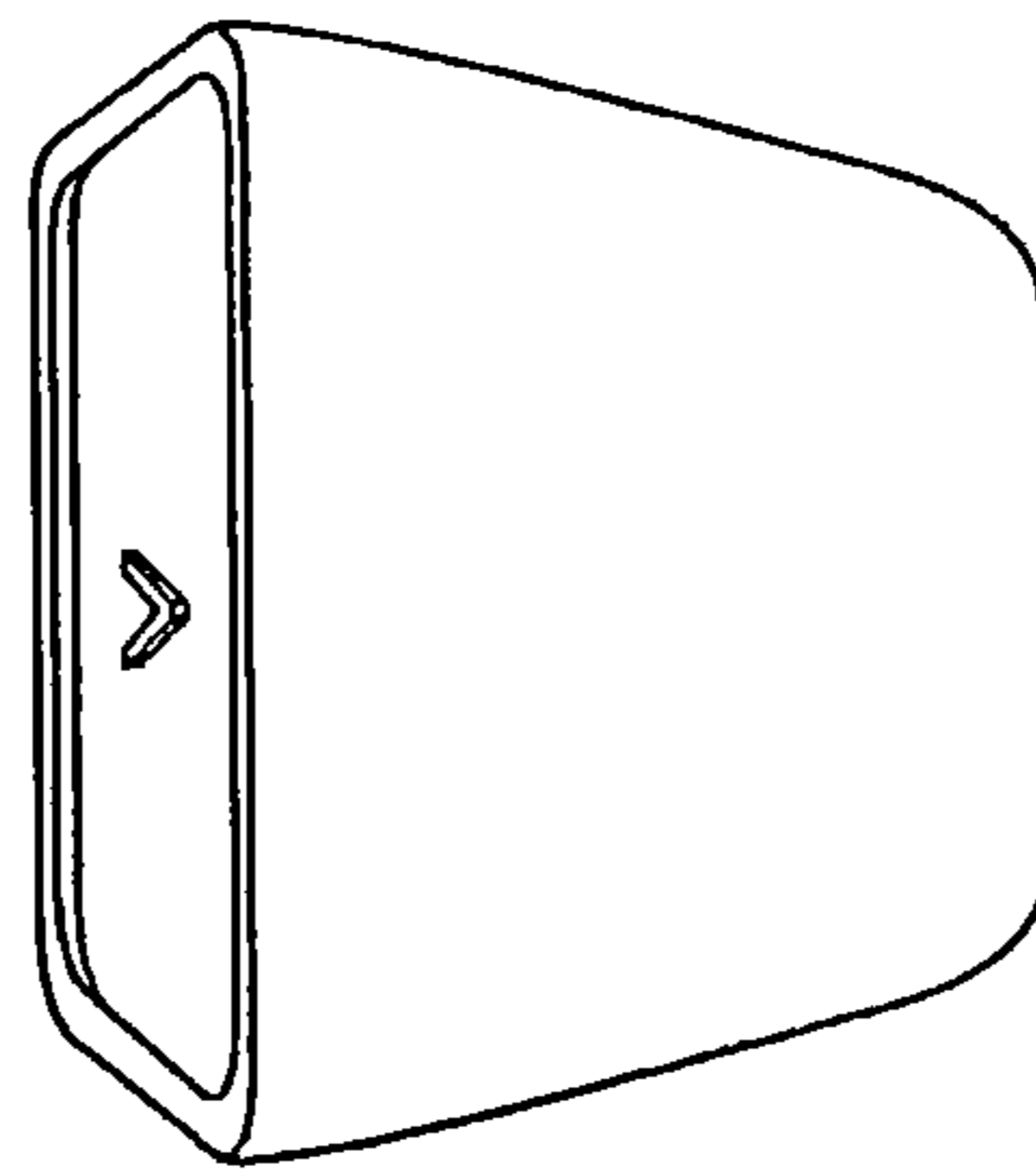

Fig. 278

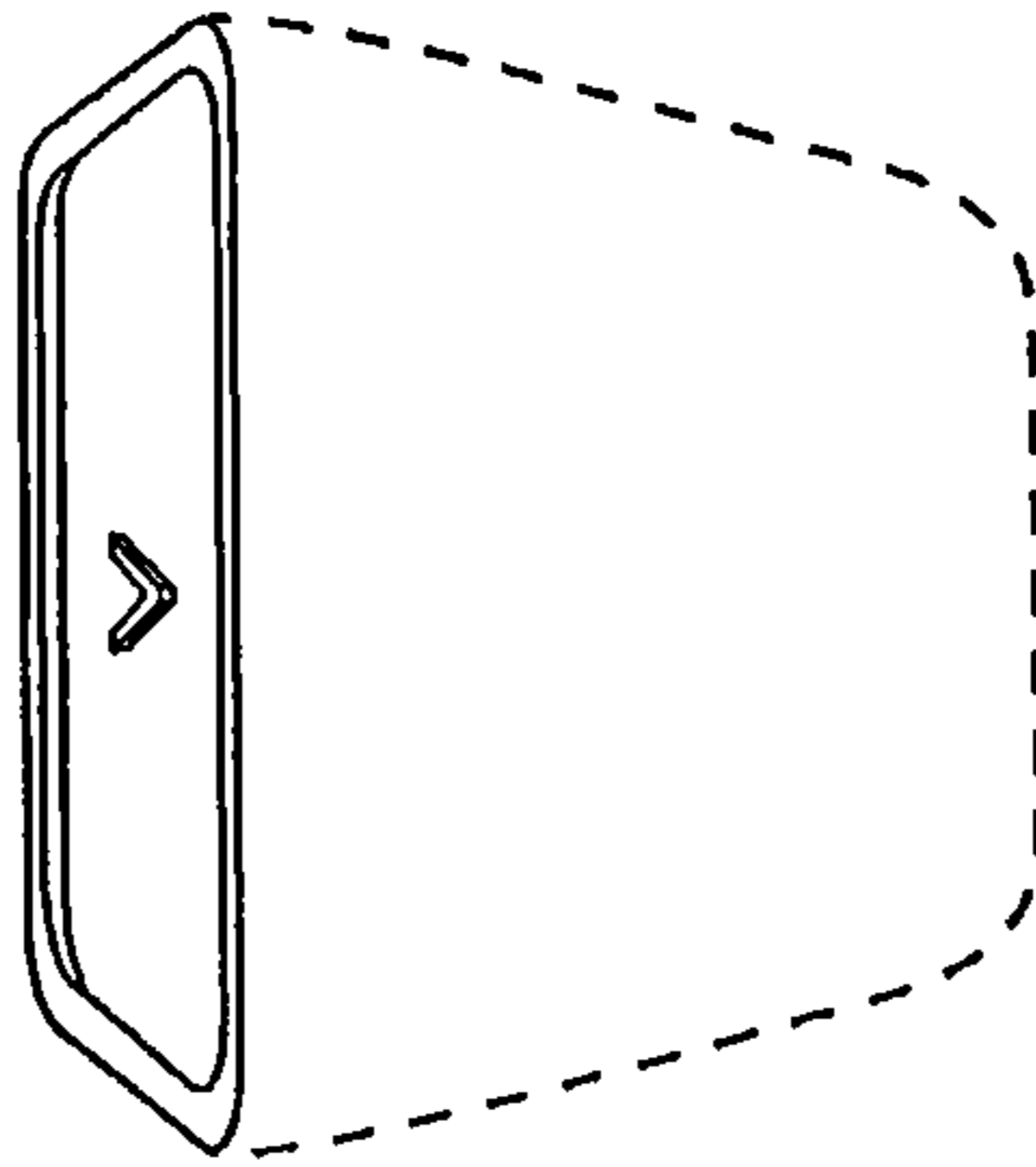

Fig. 279

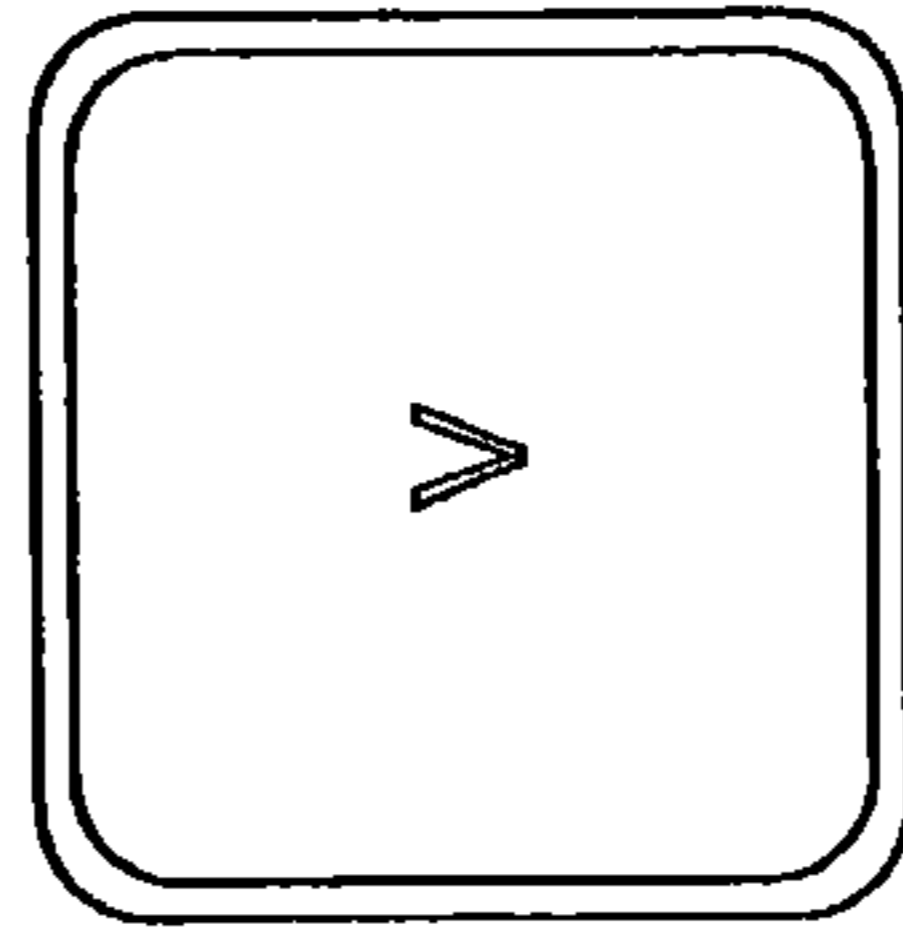

Fig. 280

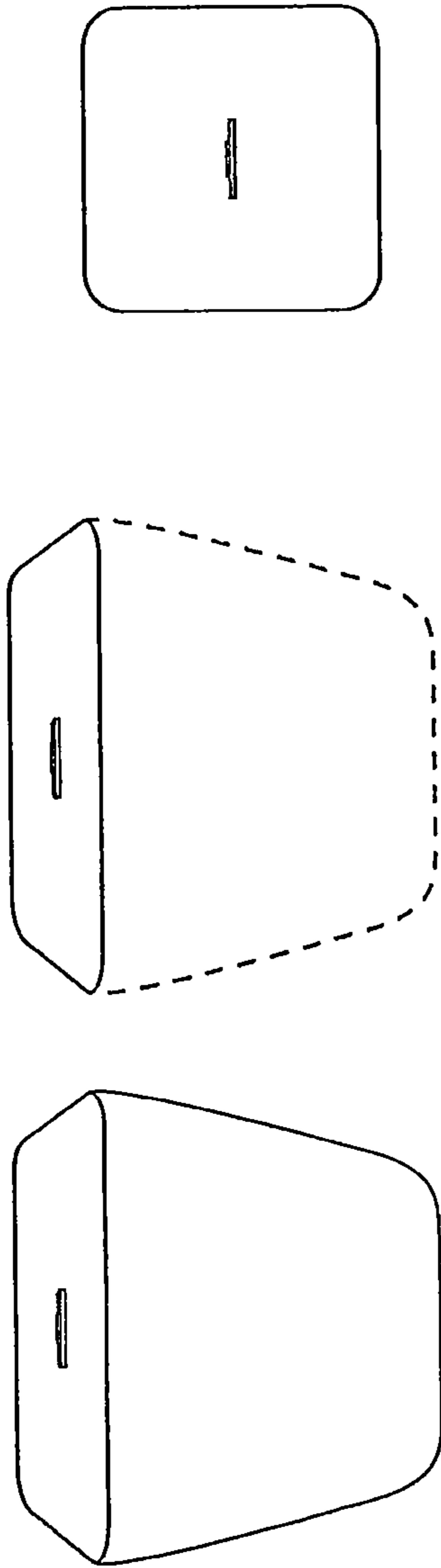

Fig. 281

Fig. 282

Fig. 283

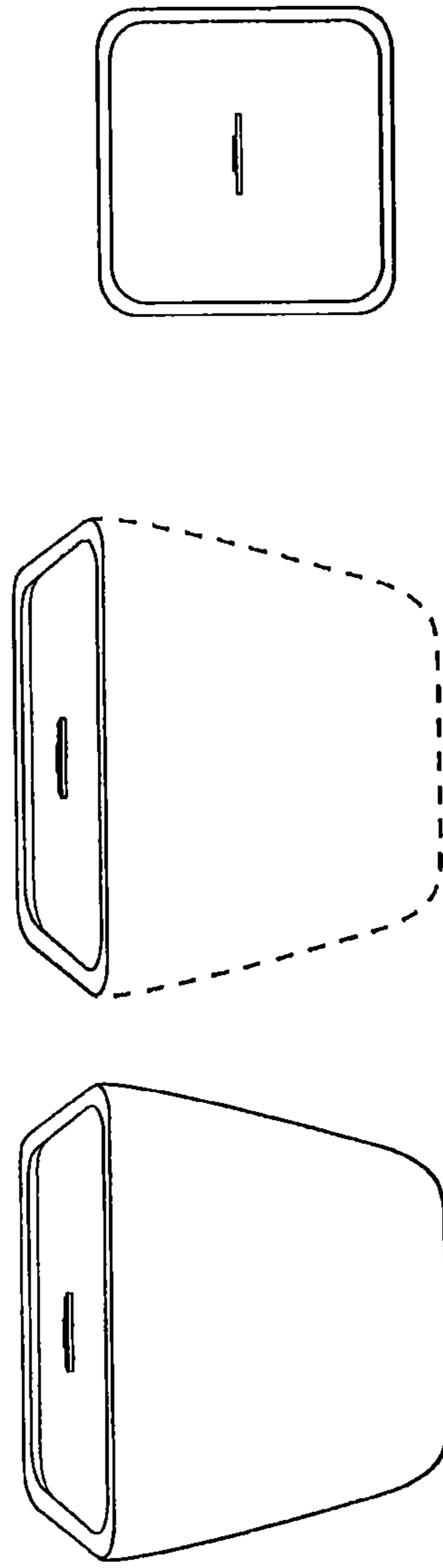

Fig. 284

Fig. 285

Fig. 286

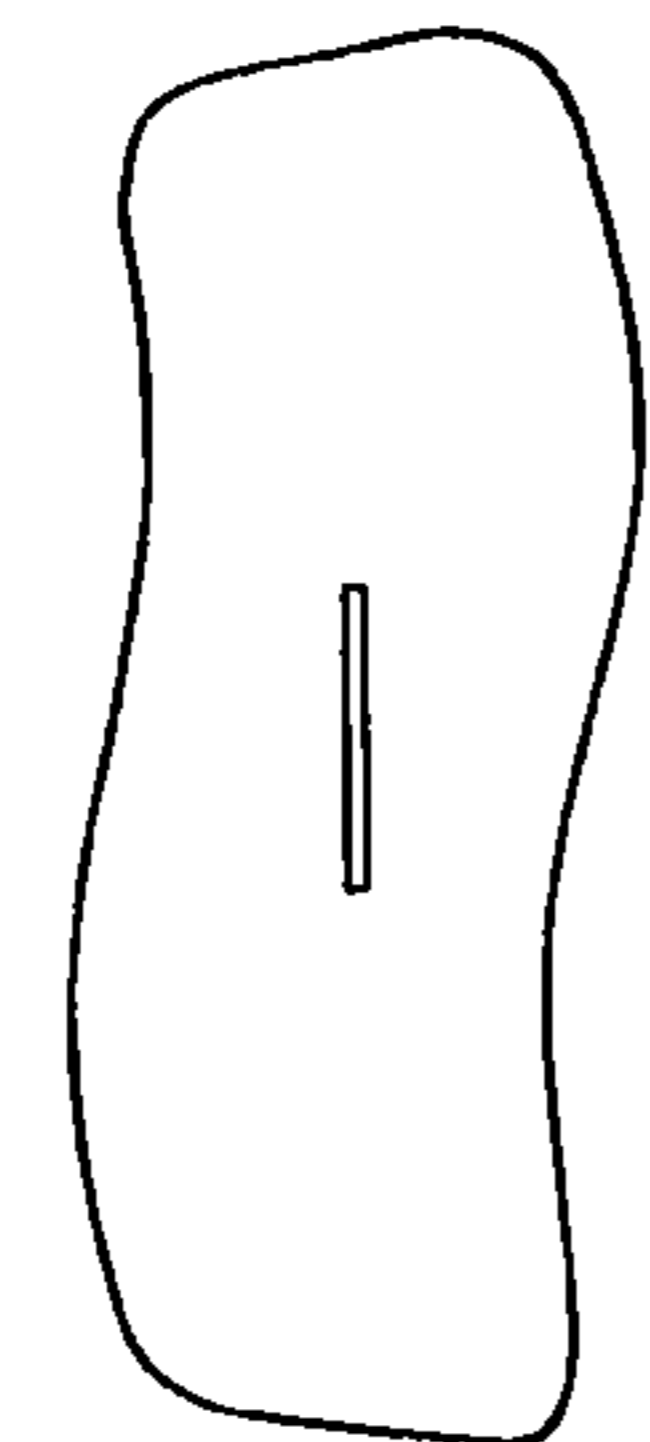

Fig. 289

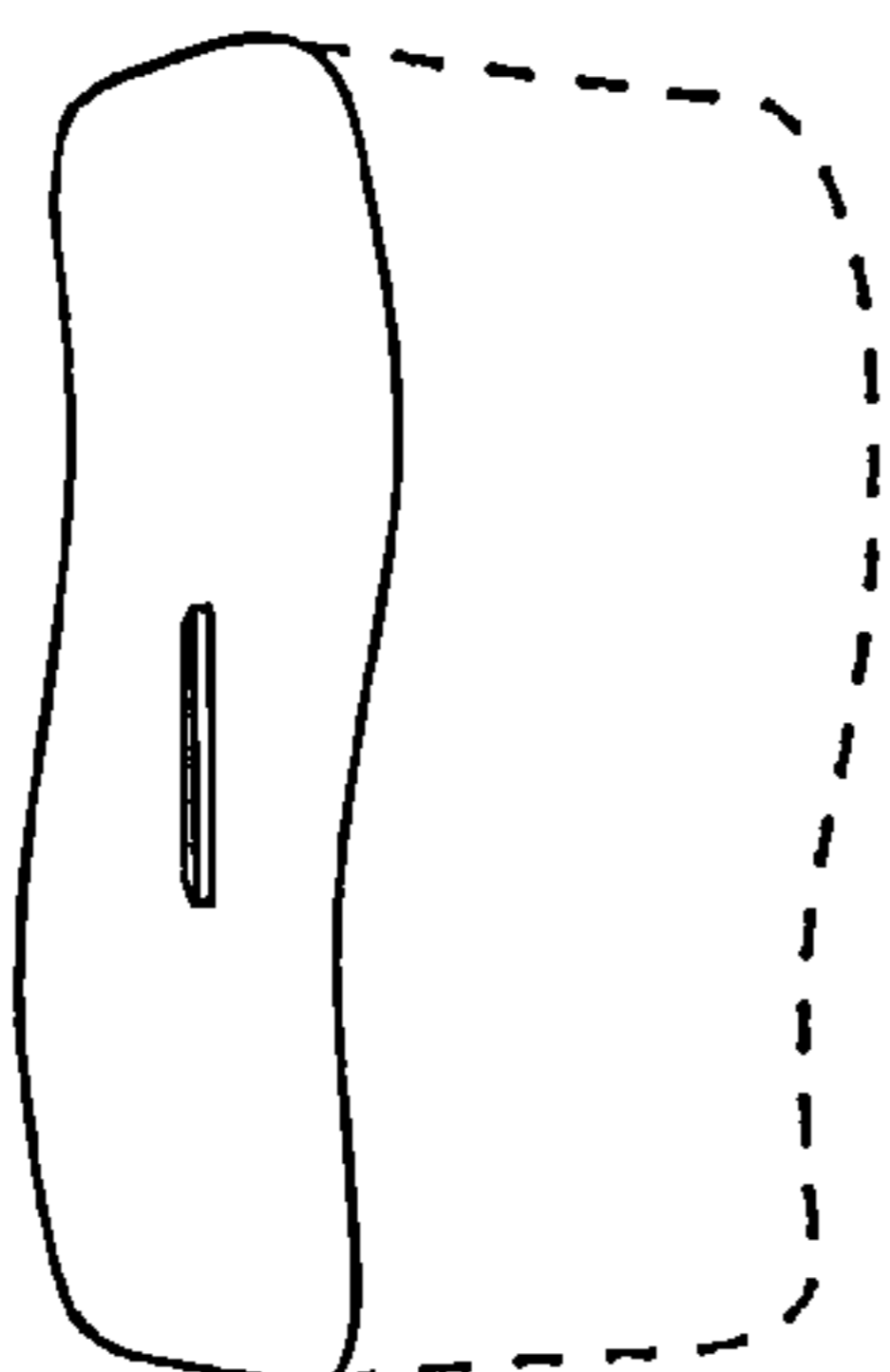

Fig. 288

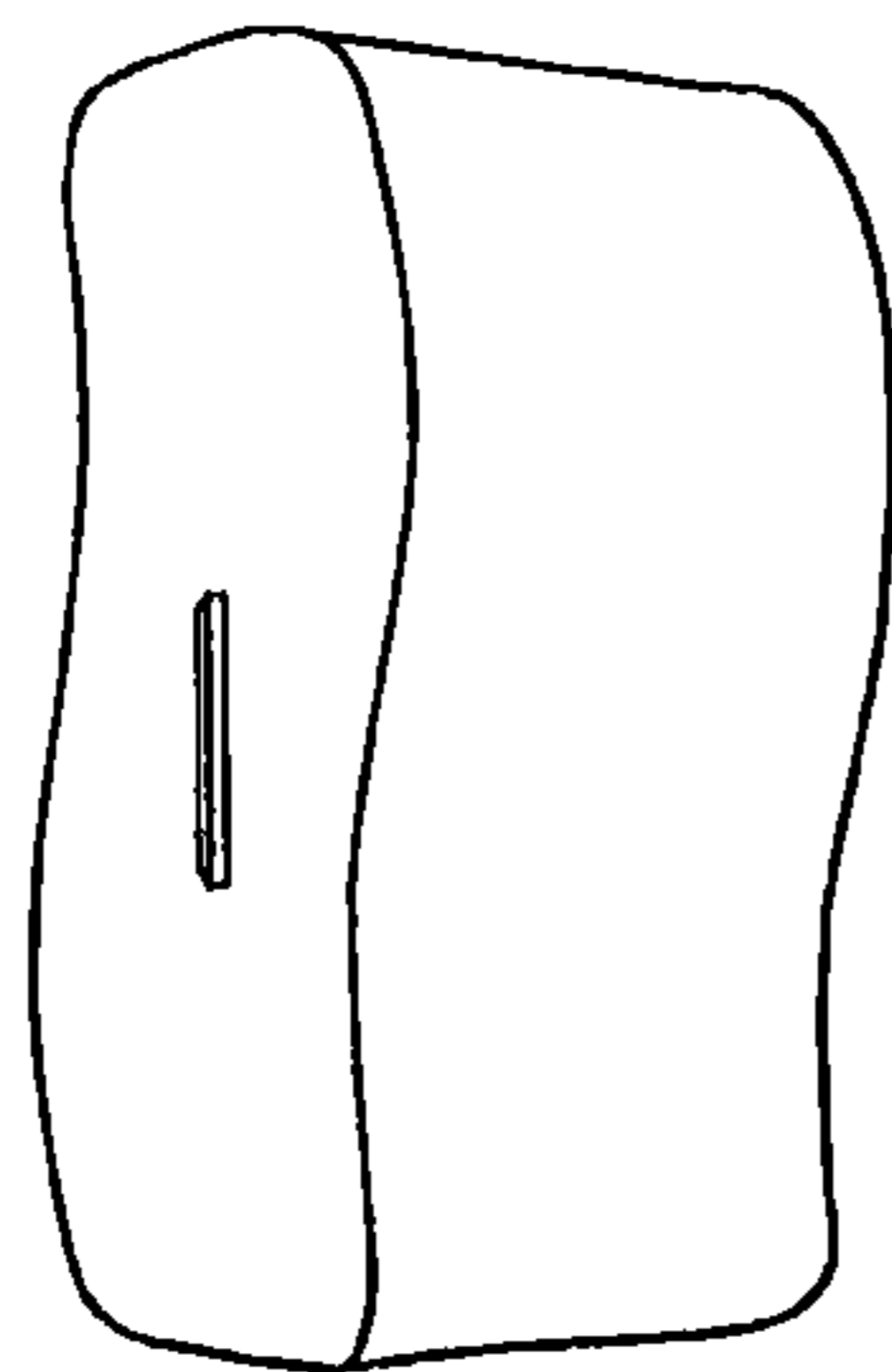

Fig. 287

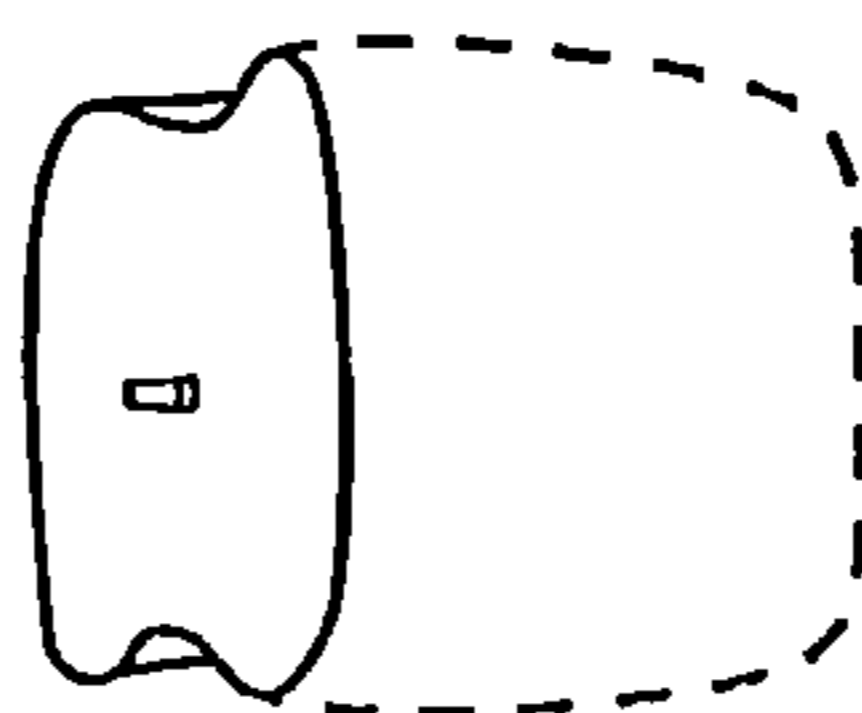

Fig. 291

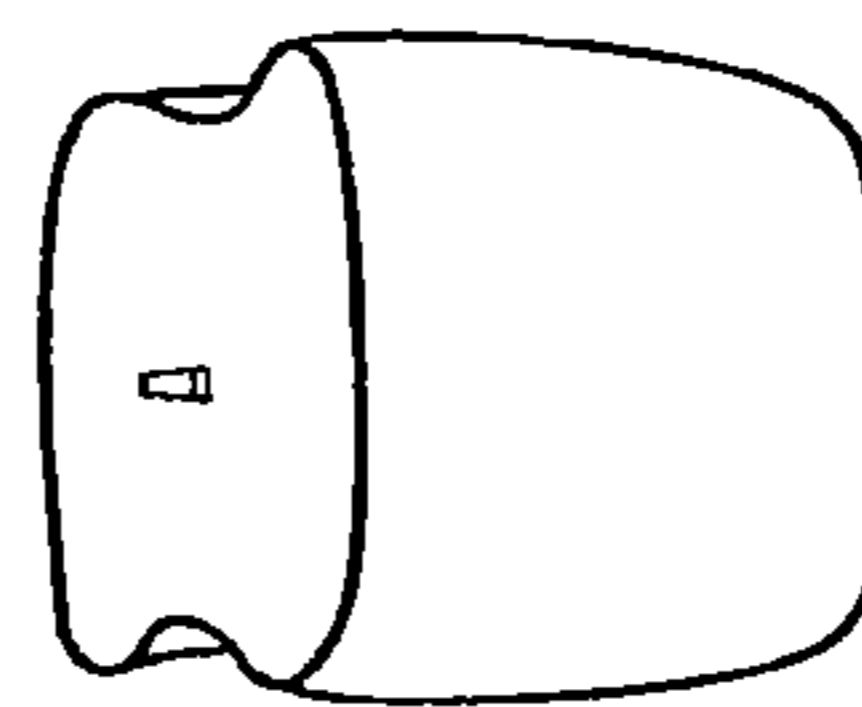

Fig. 290

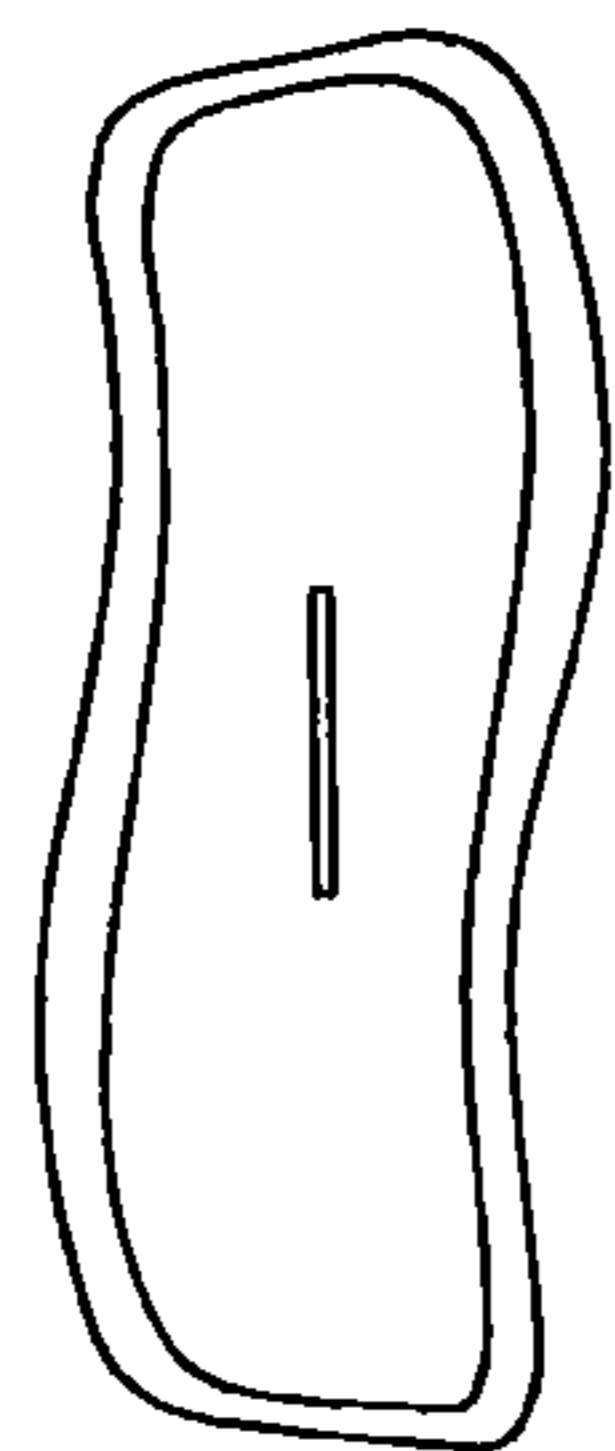

Fig. 294

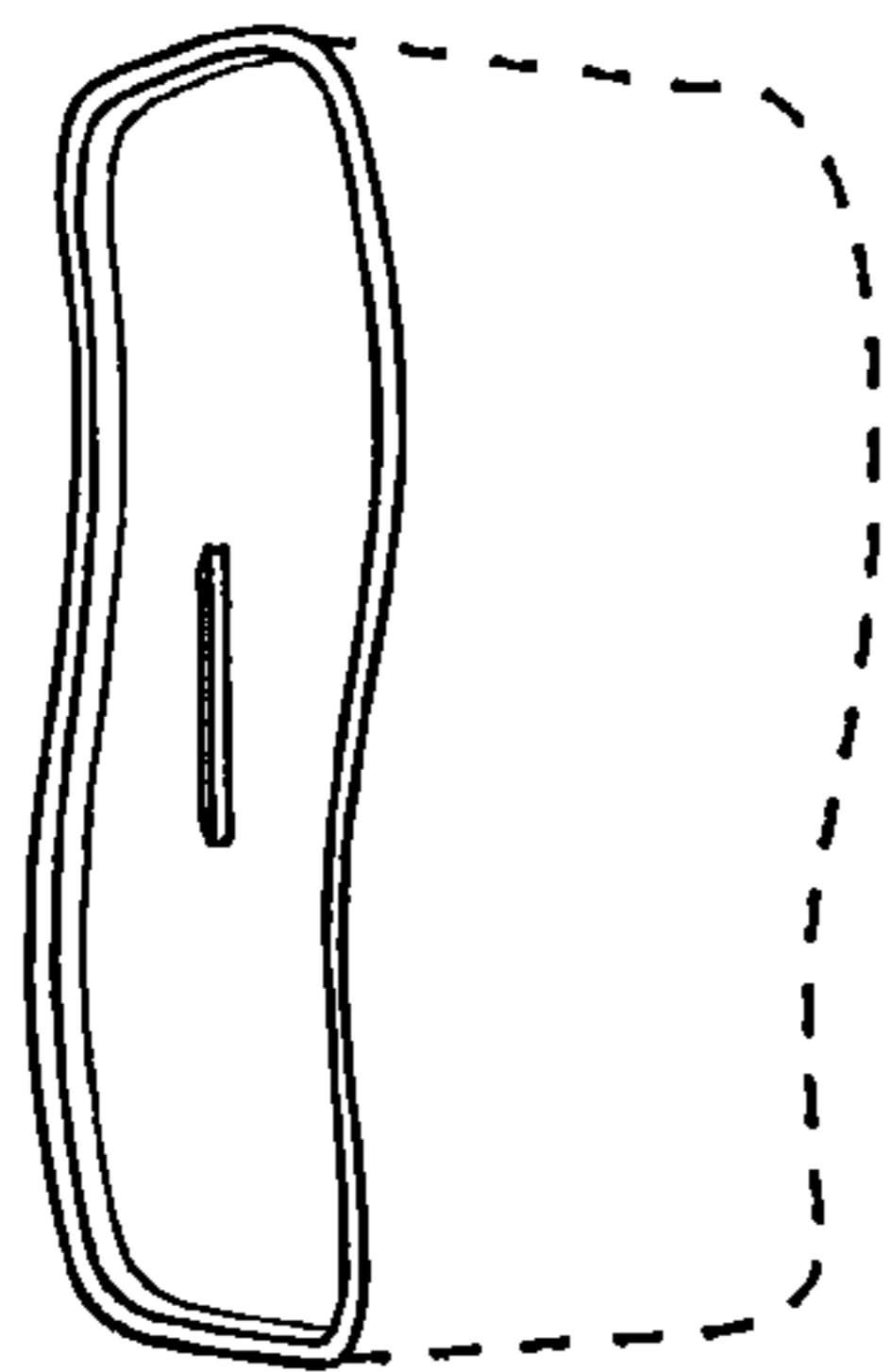

Fig. 293

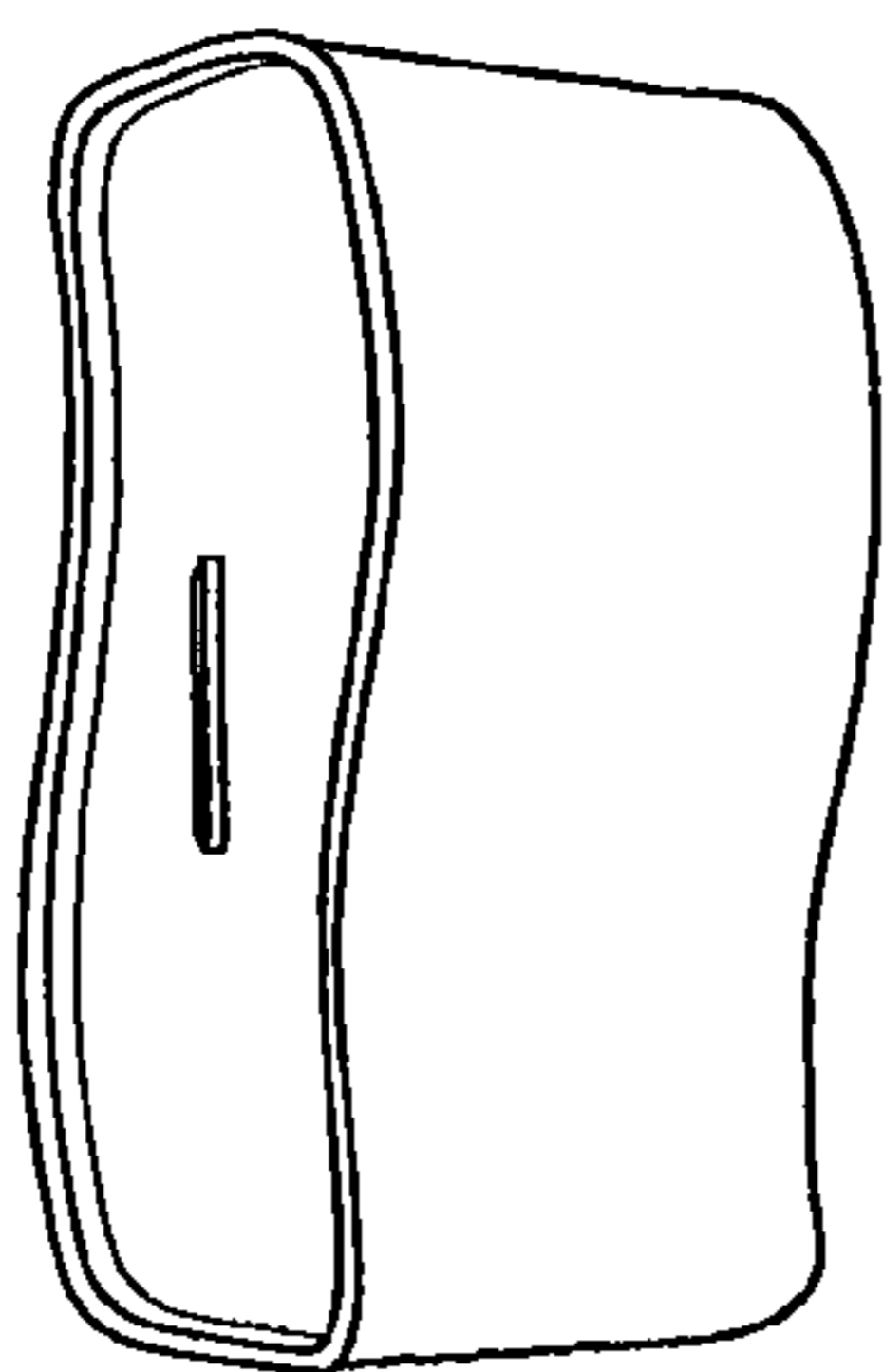

Fig. 292

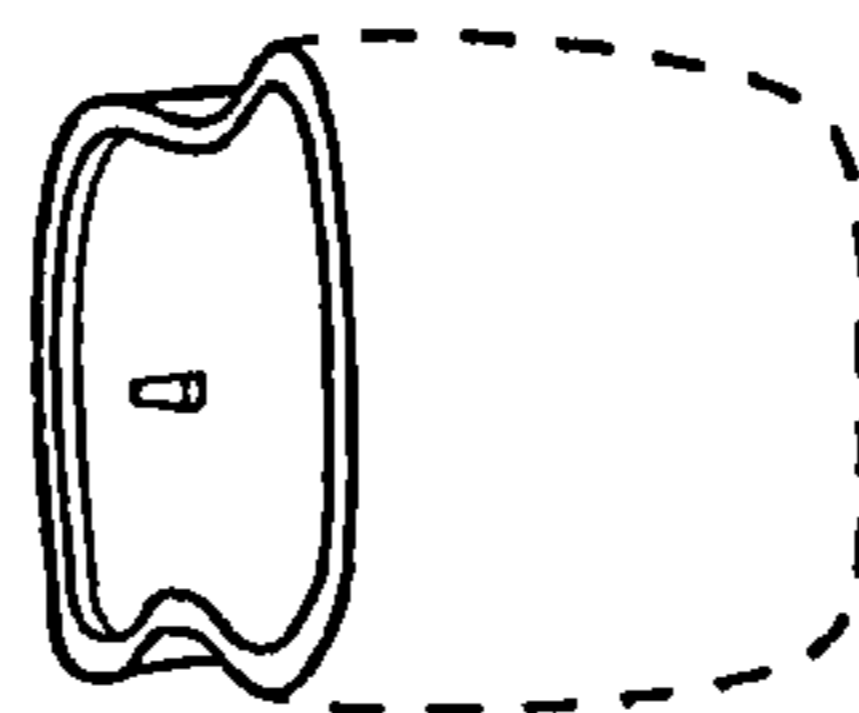

Fig. 296

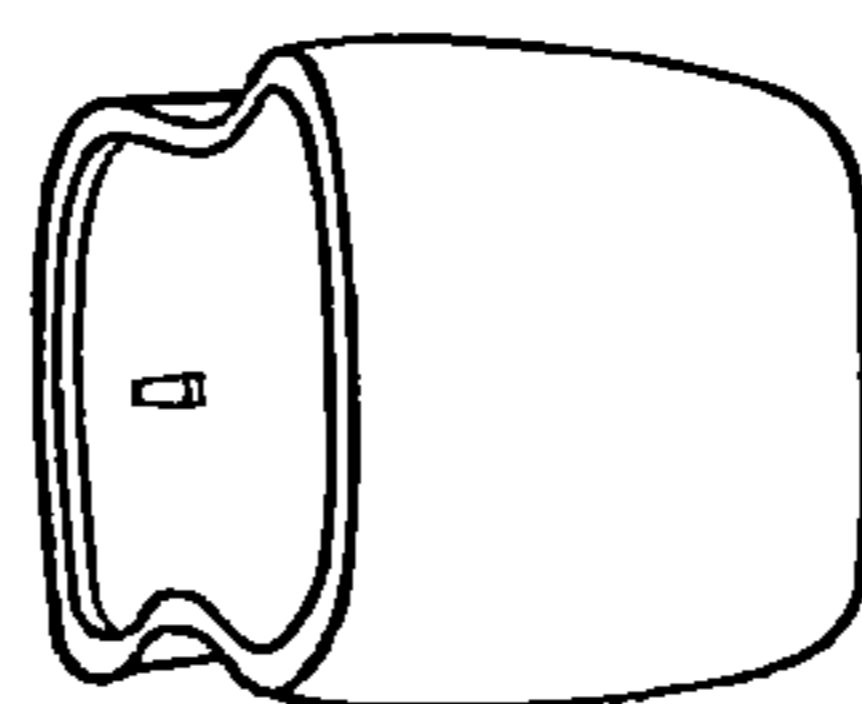

Fig. 295

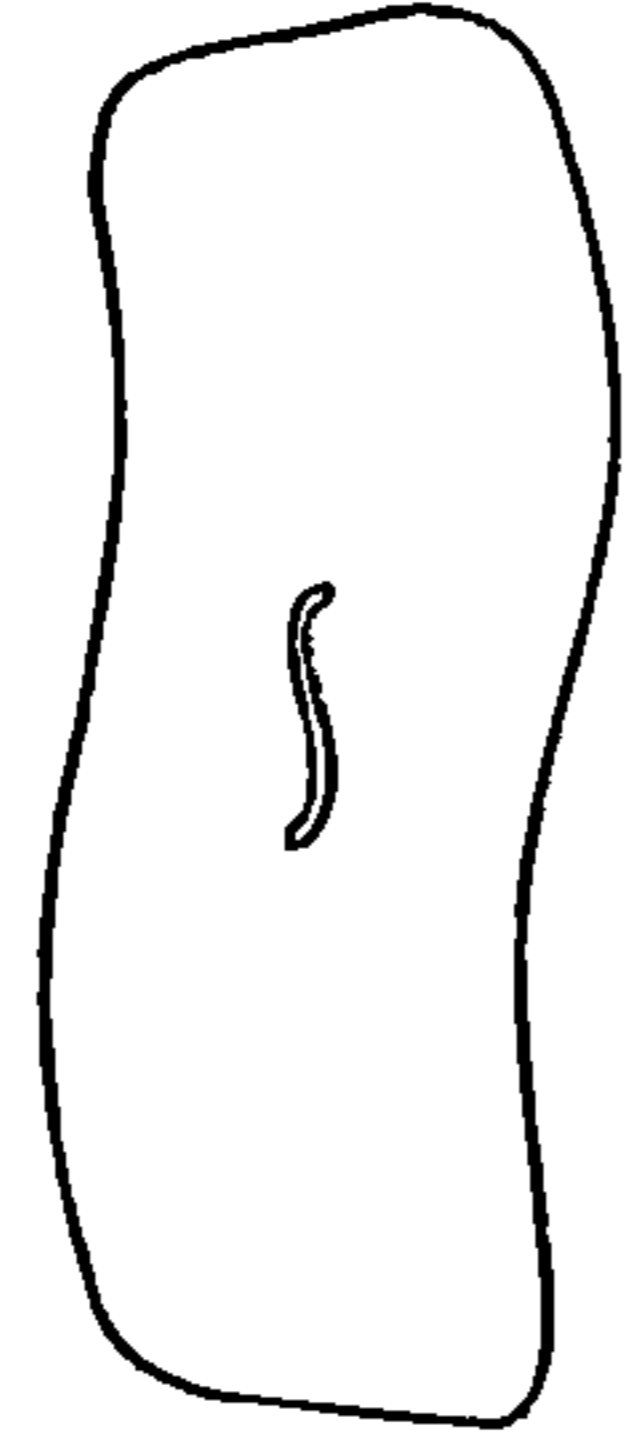

Fig. 299

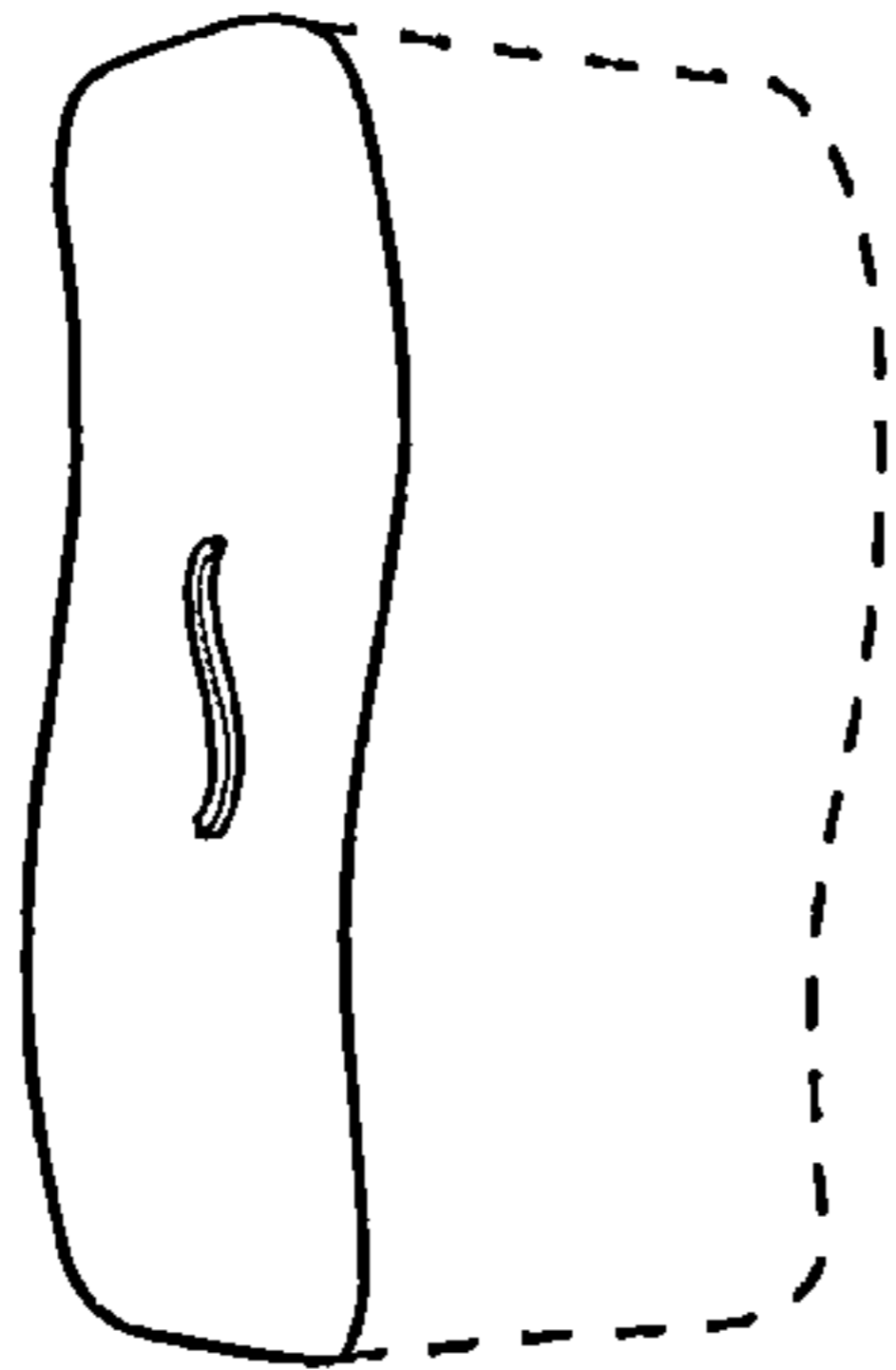

Fig. 298

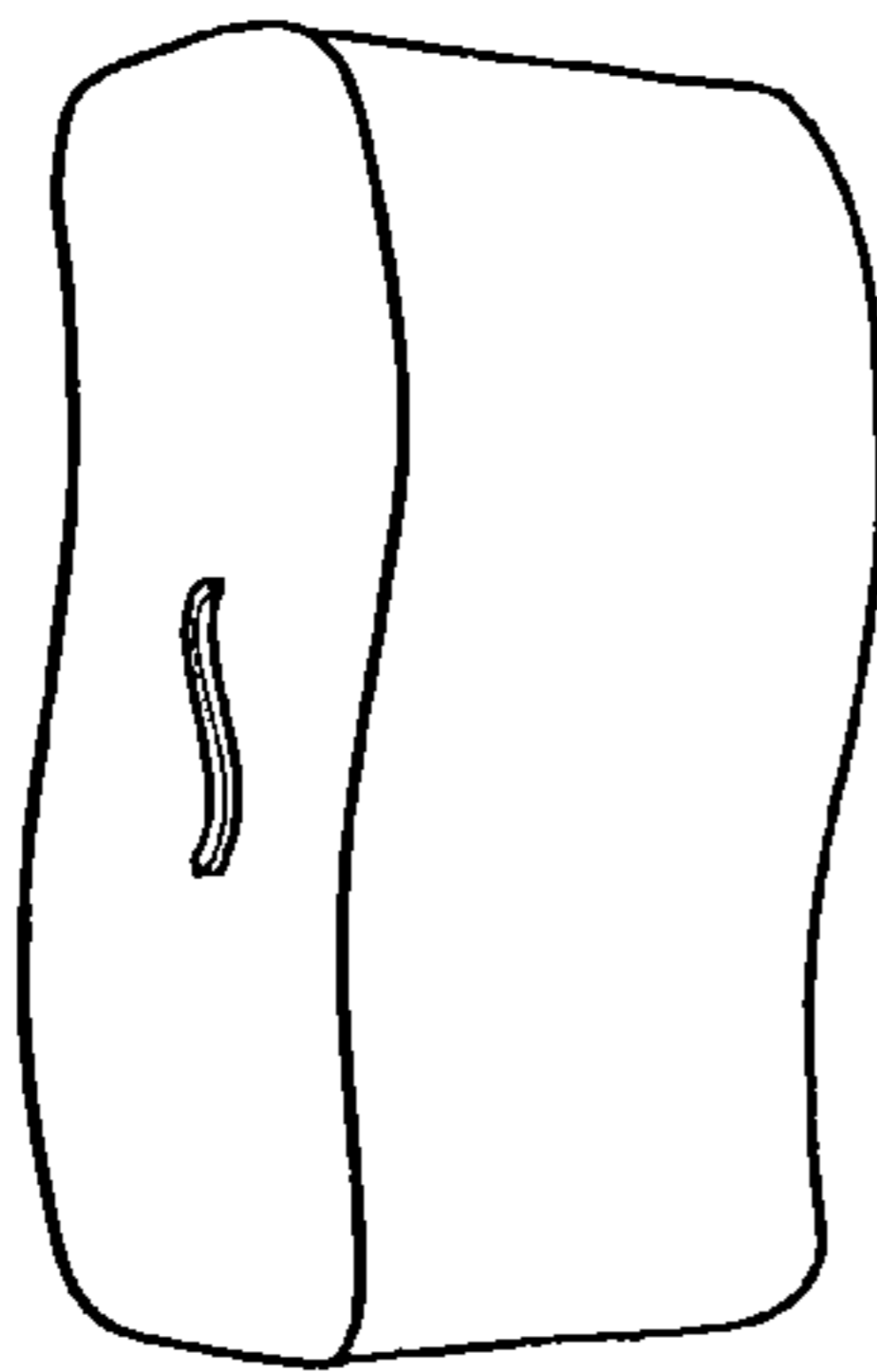

Fig. 297

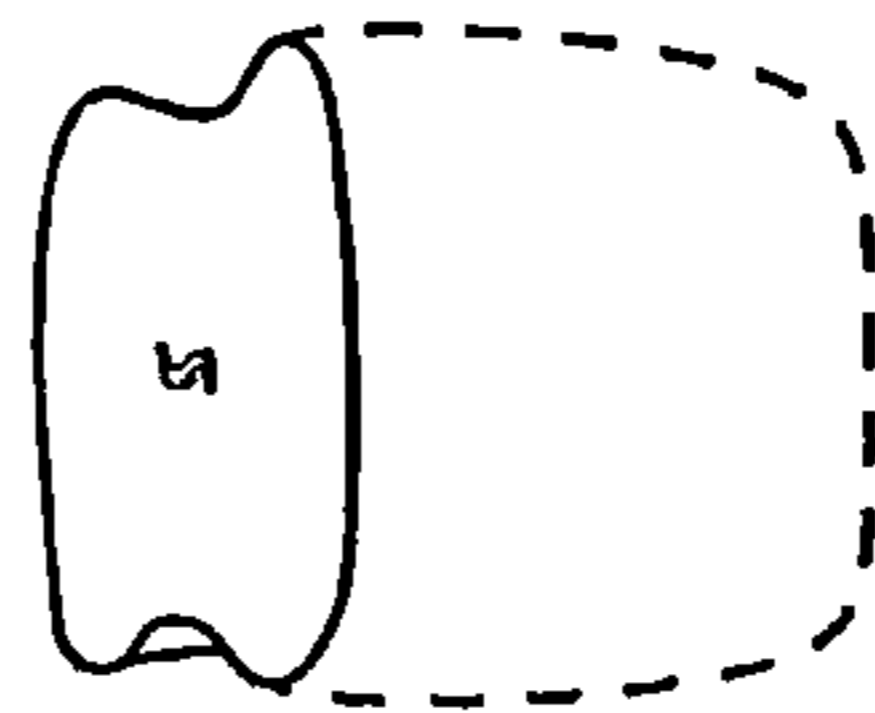

Fig. 301

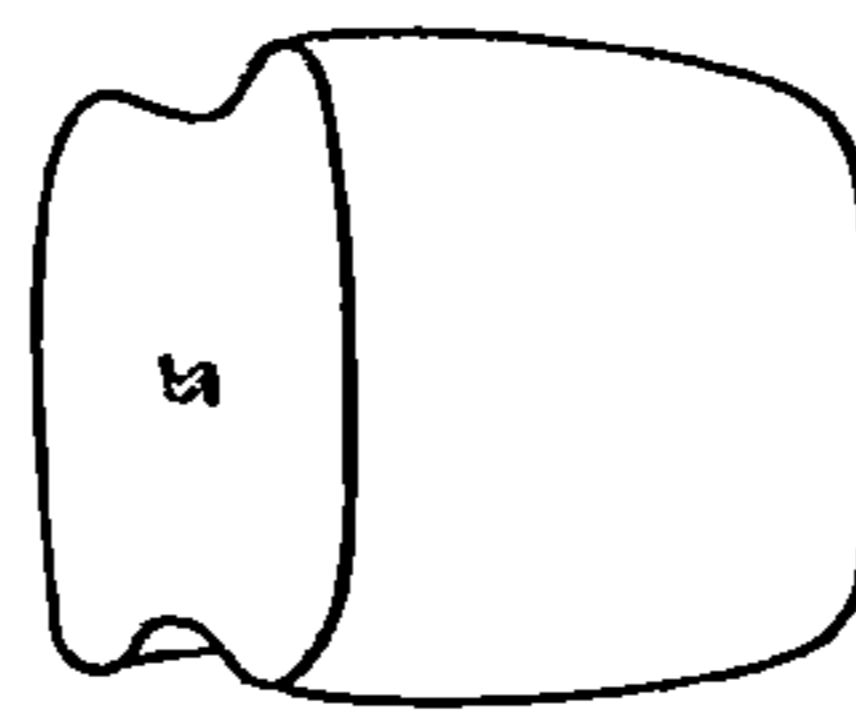

Fig. 300

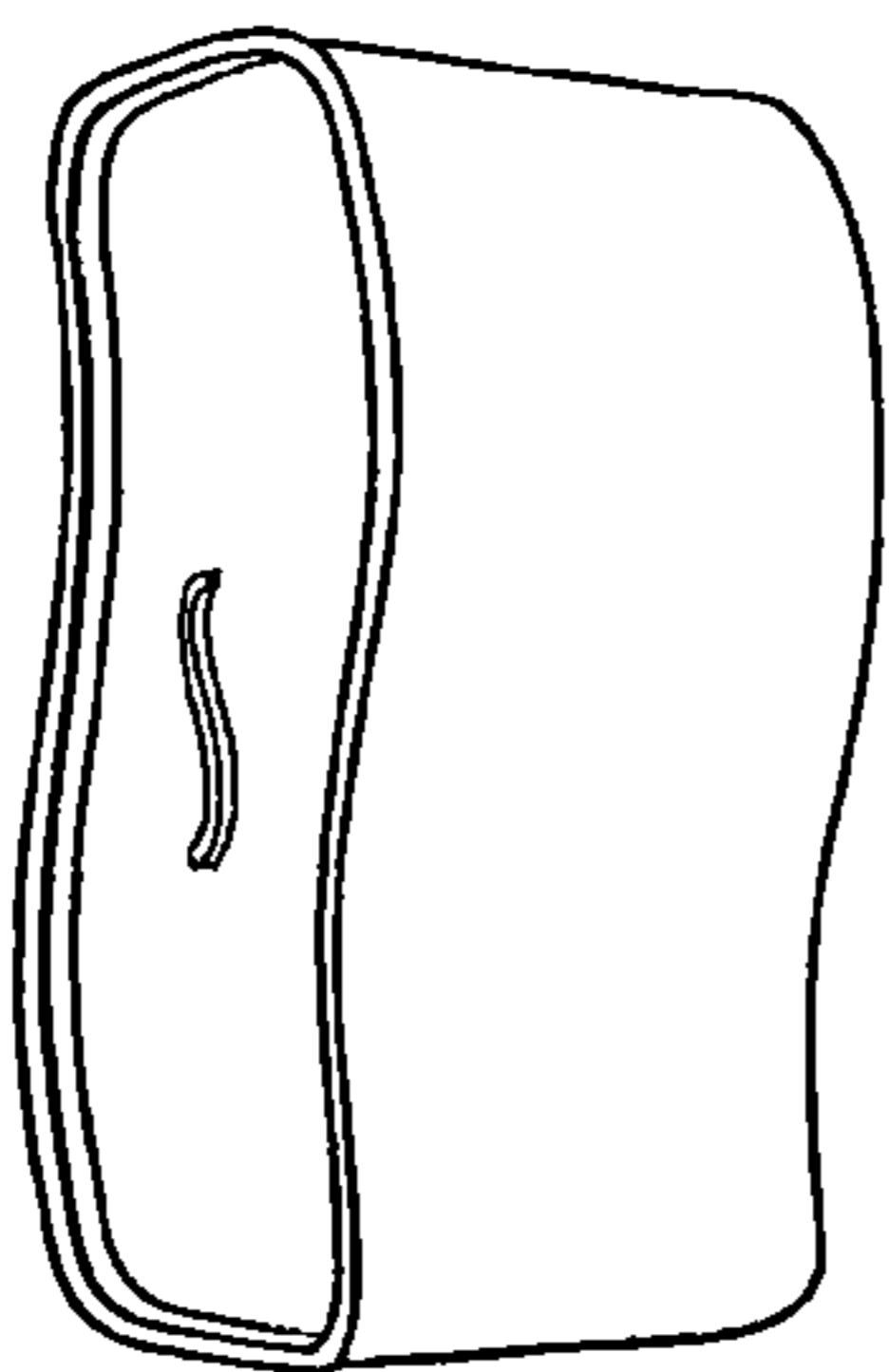

Fig. 302

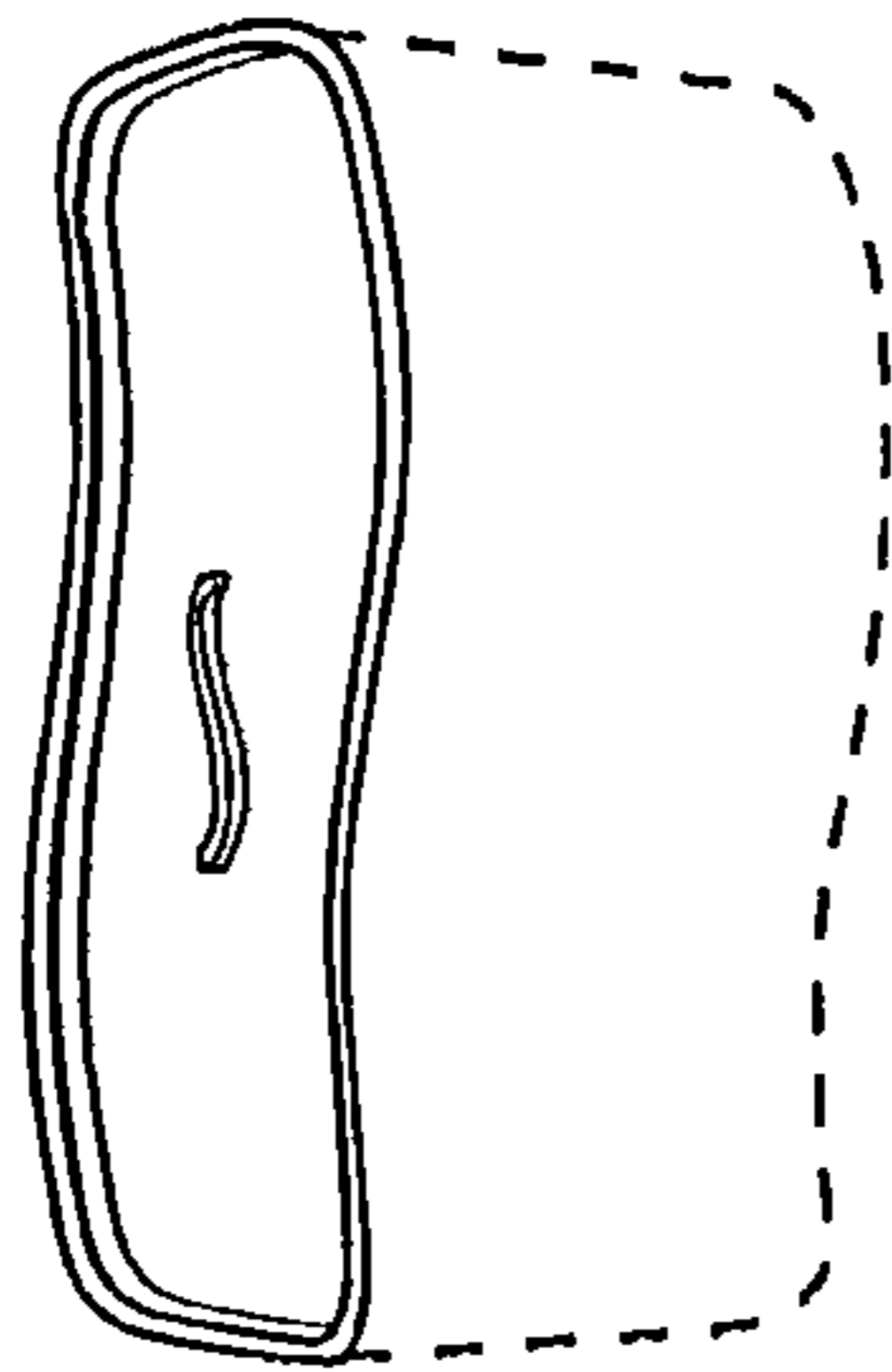

Fig. 303

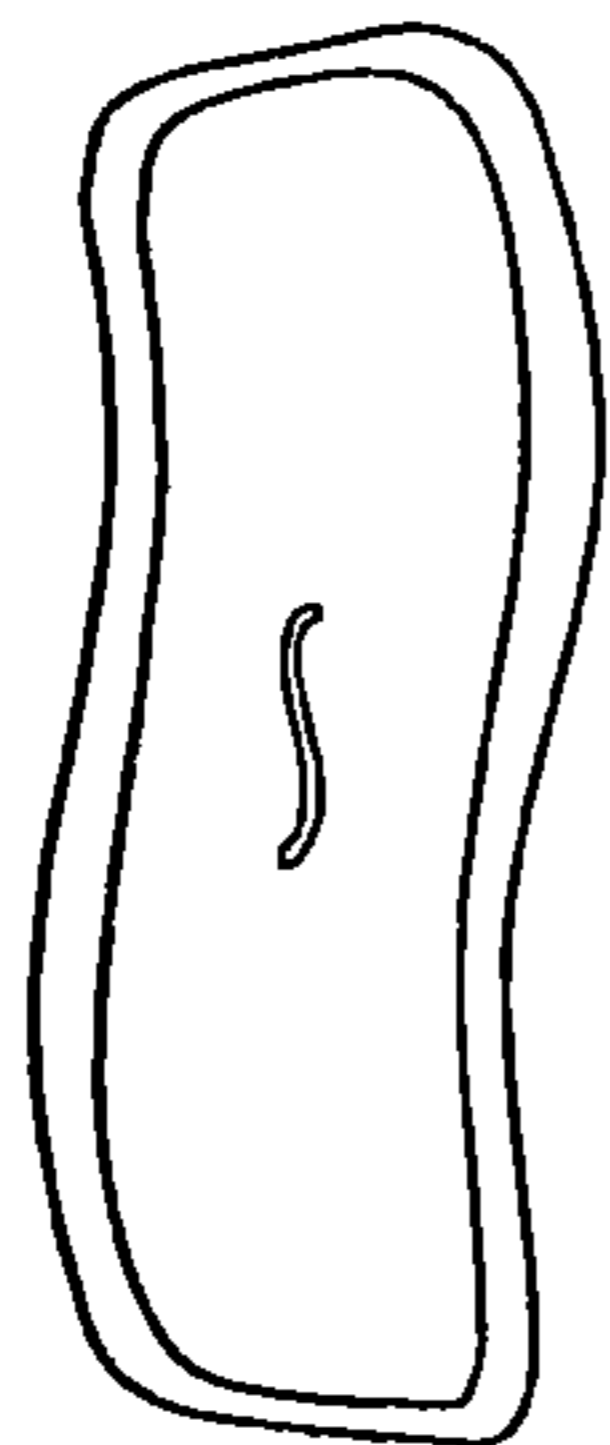

Fig. 304

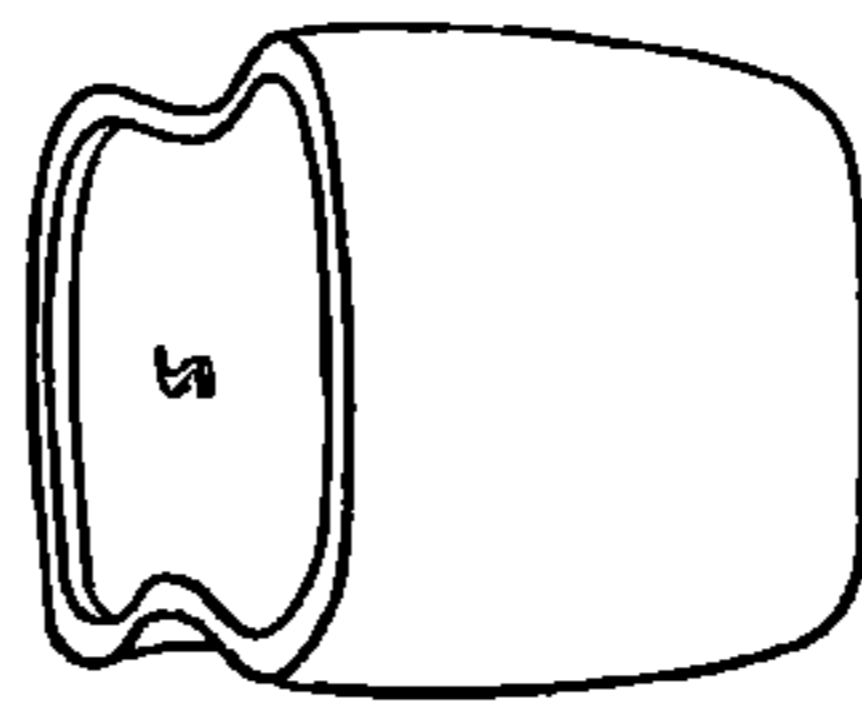

Fig. 305

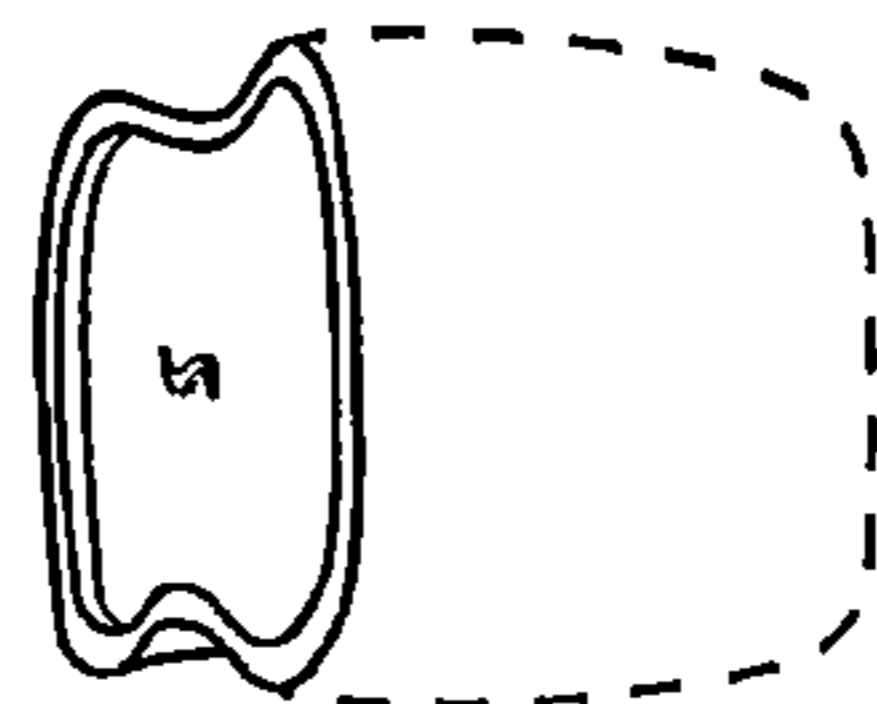

Fig. 306

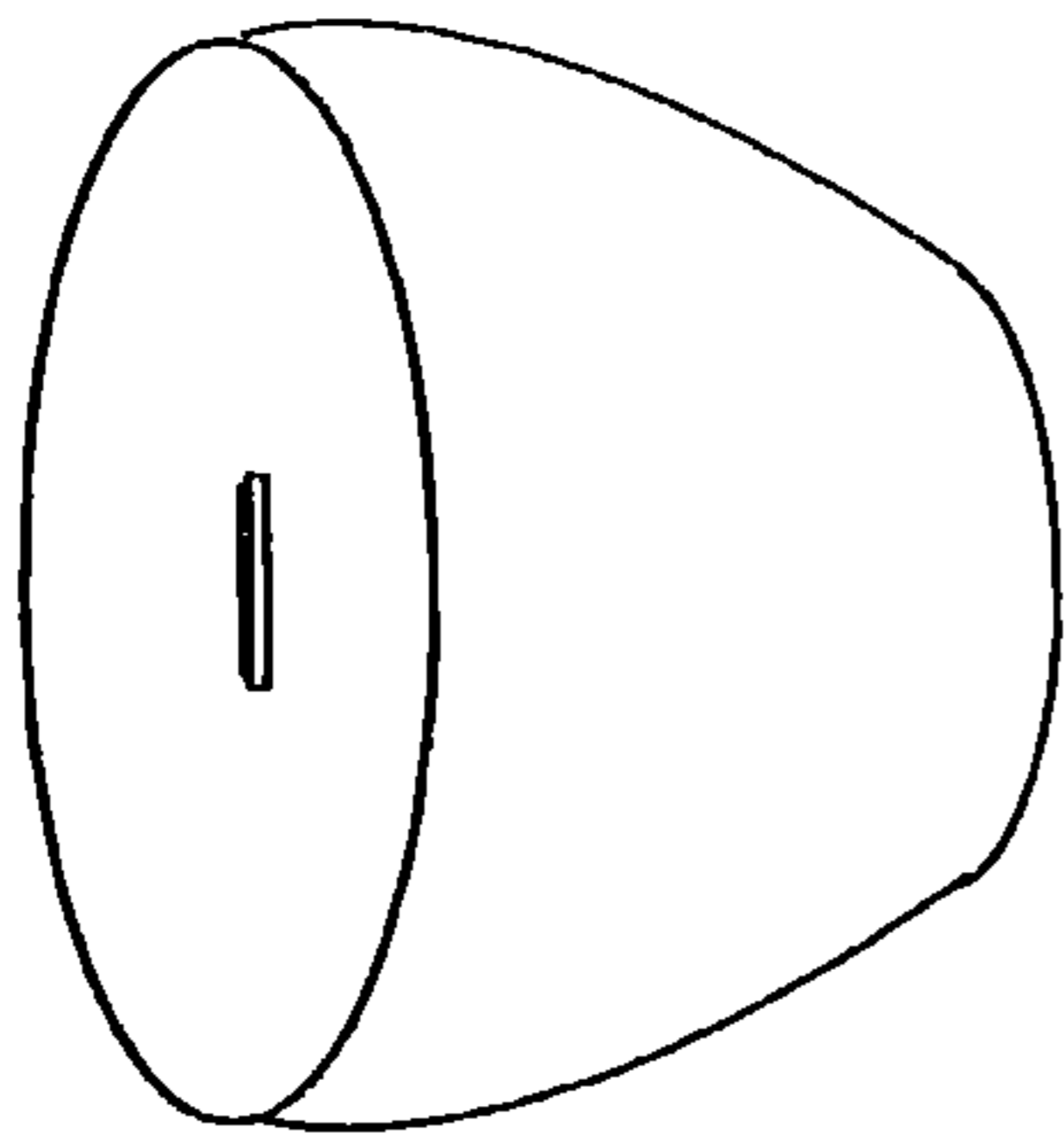

Fig. 307

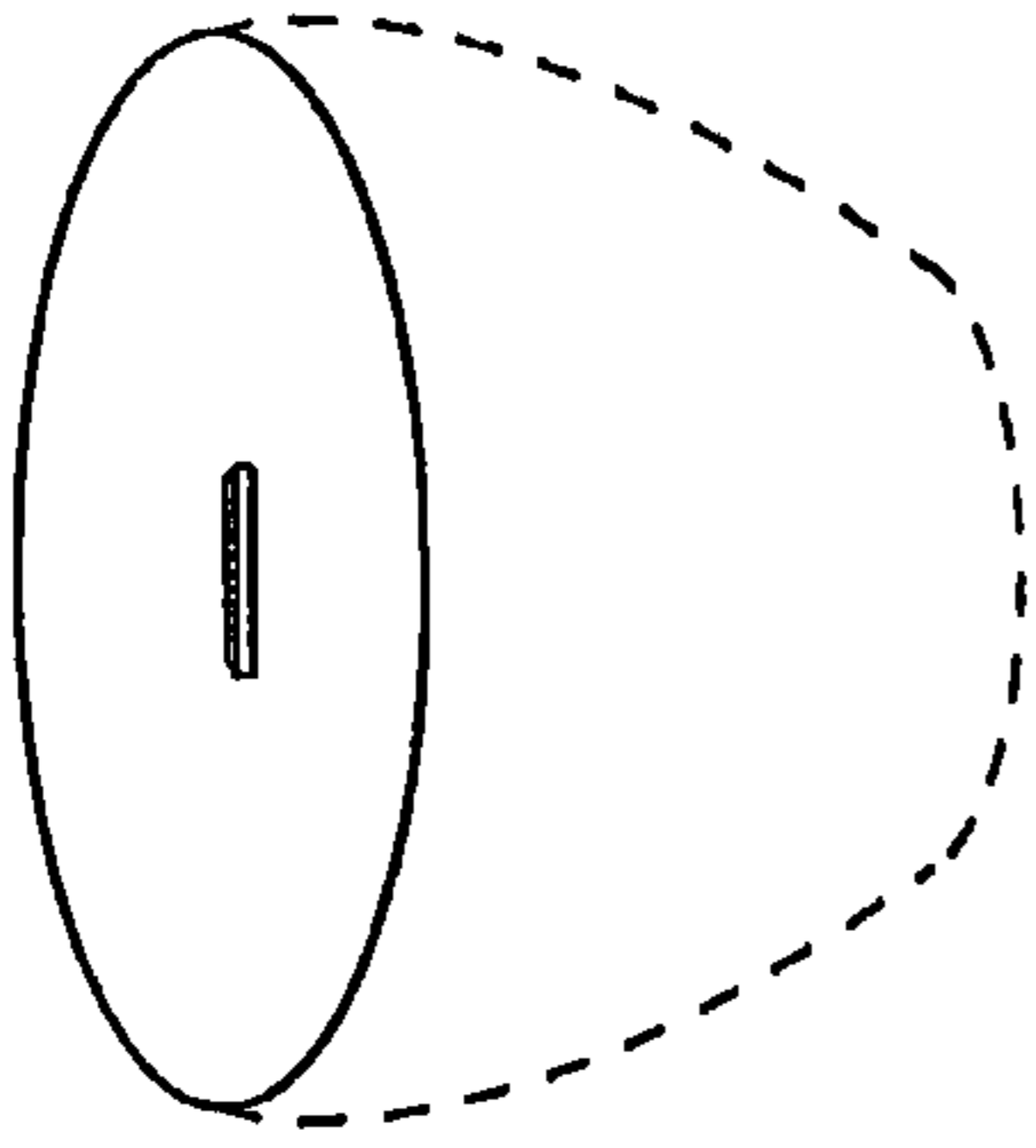

Fig. 308

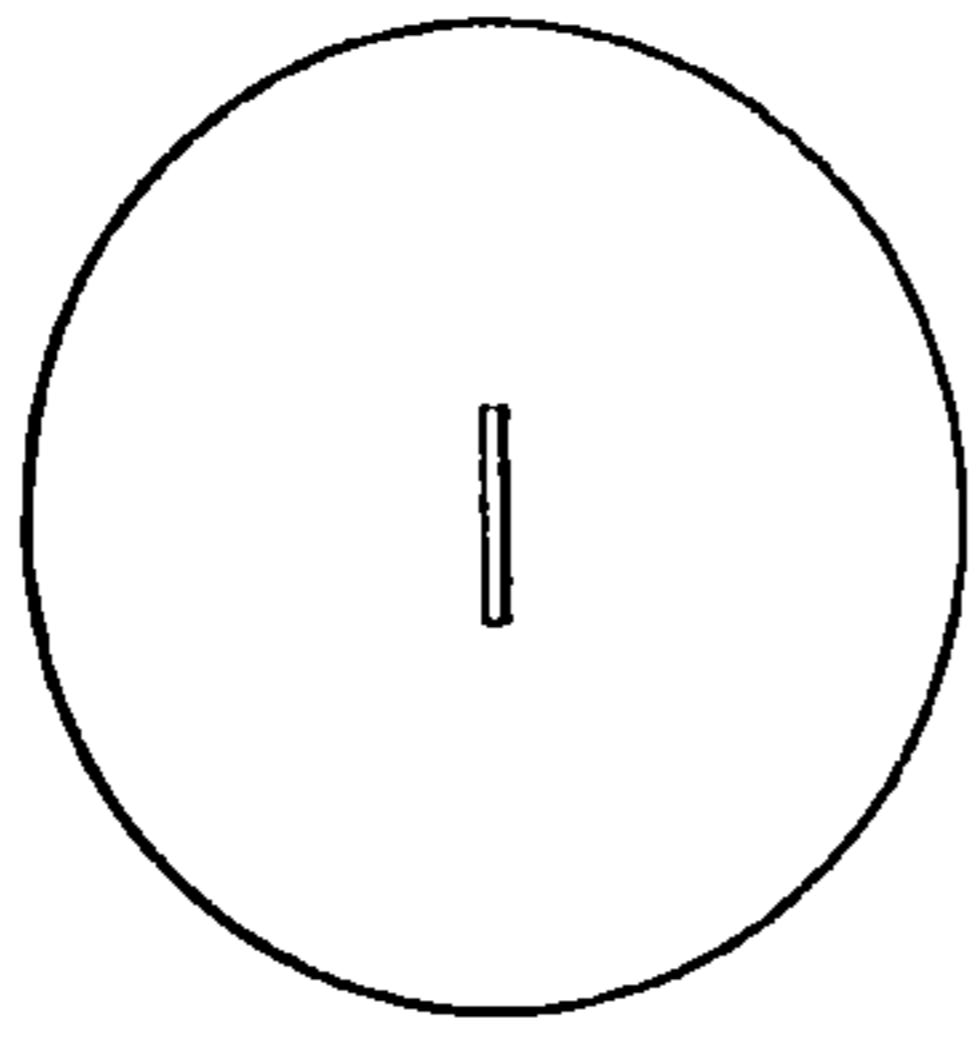

Fig. 309

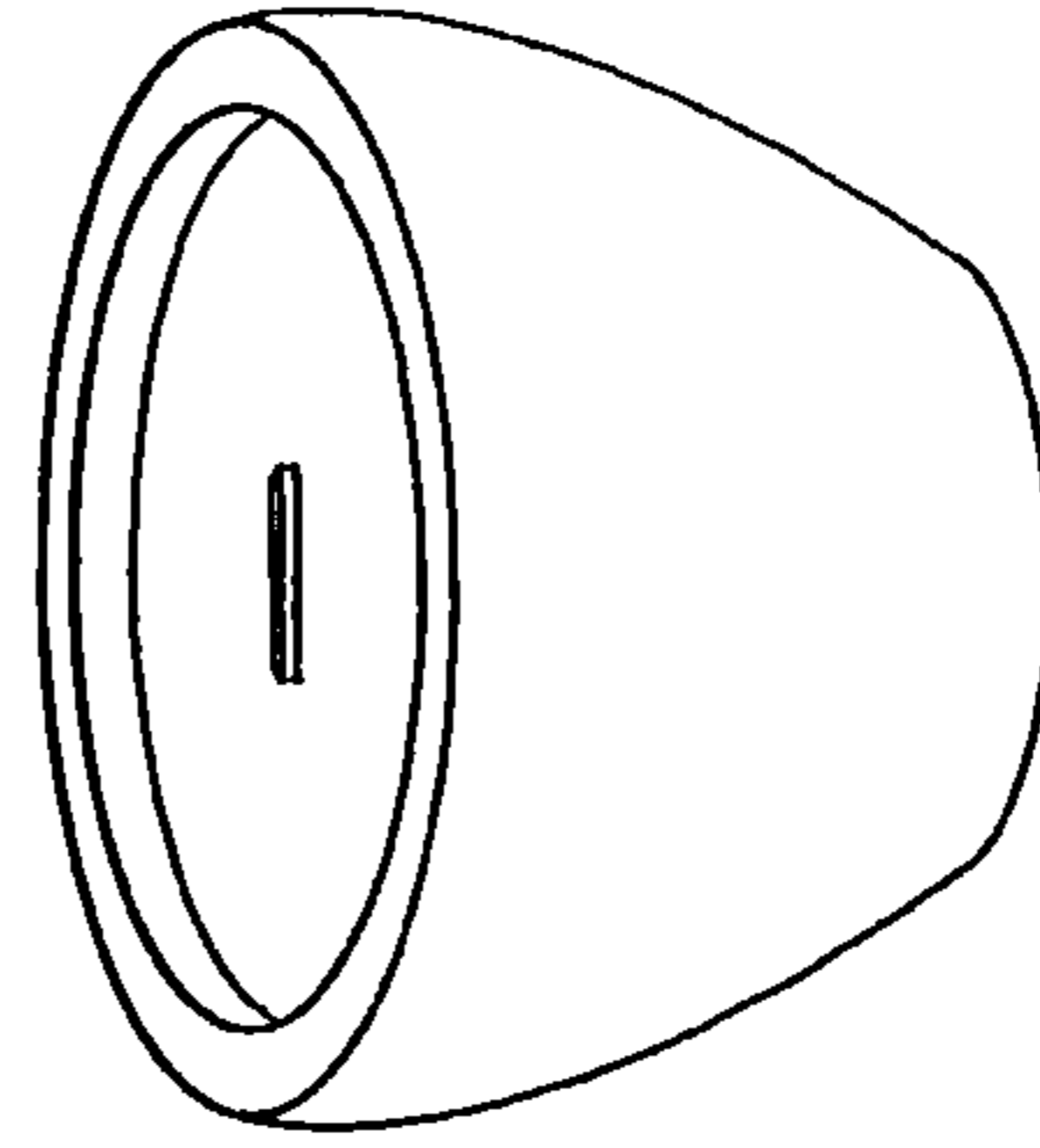

Fig. 310

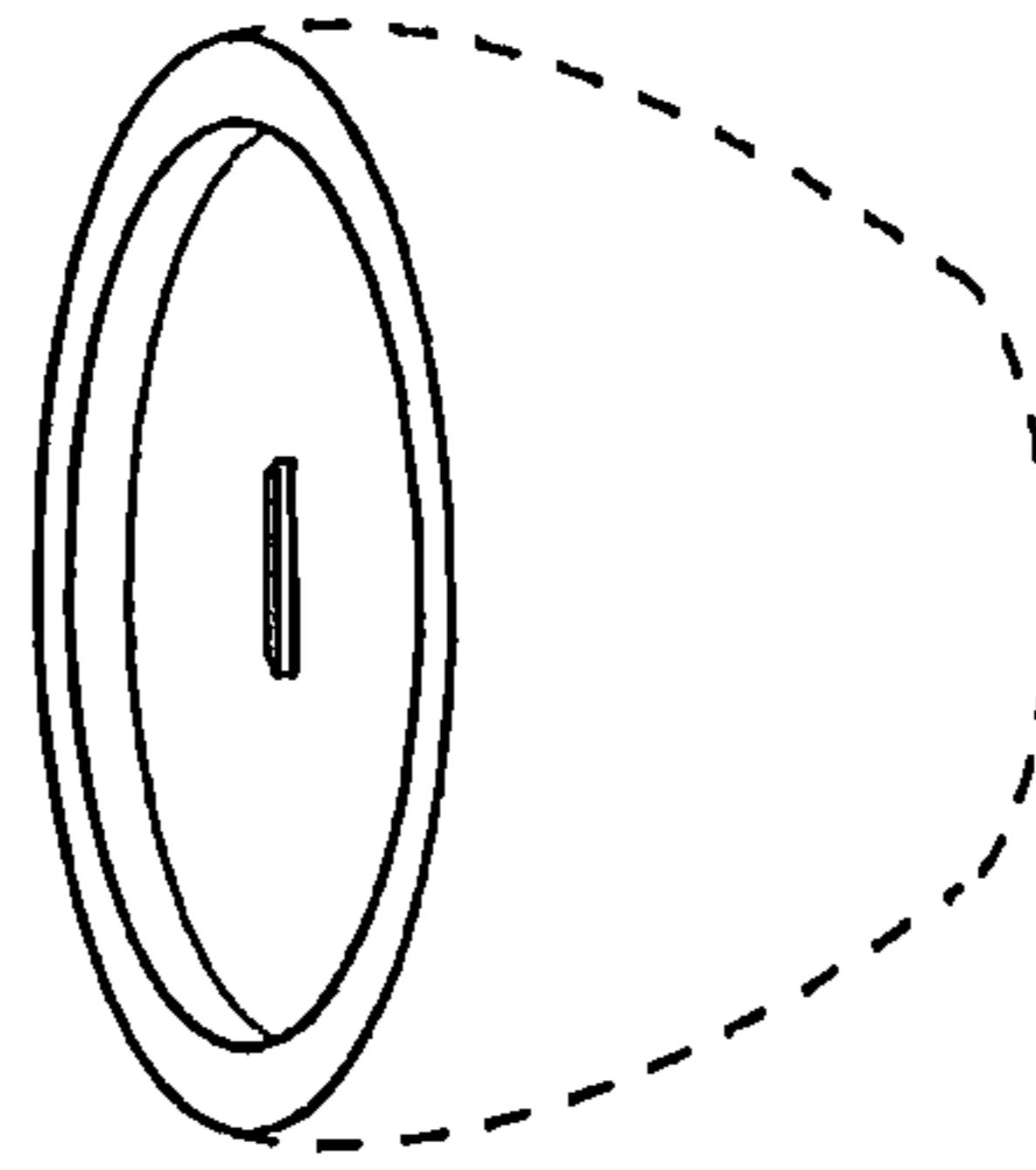

Fig. 311

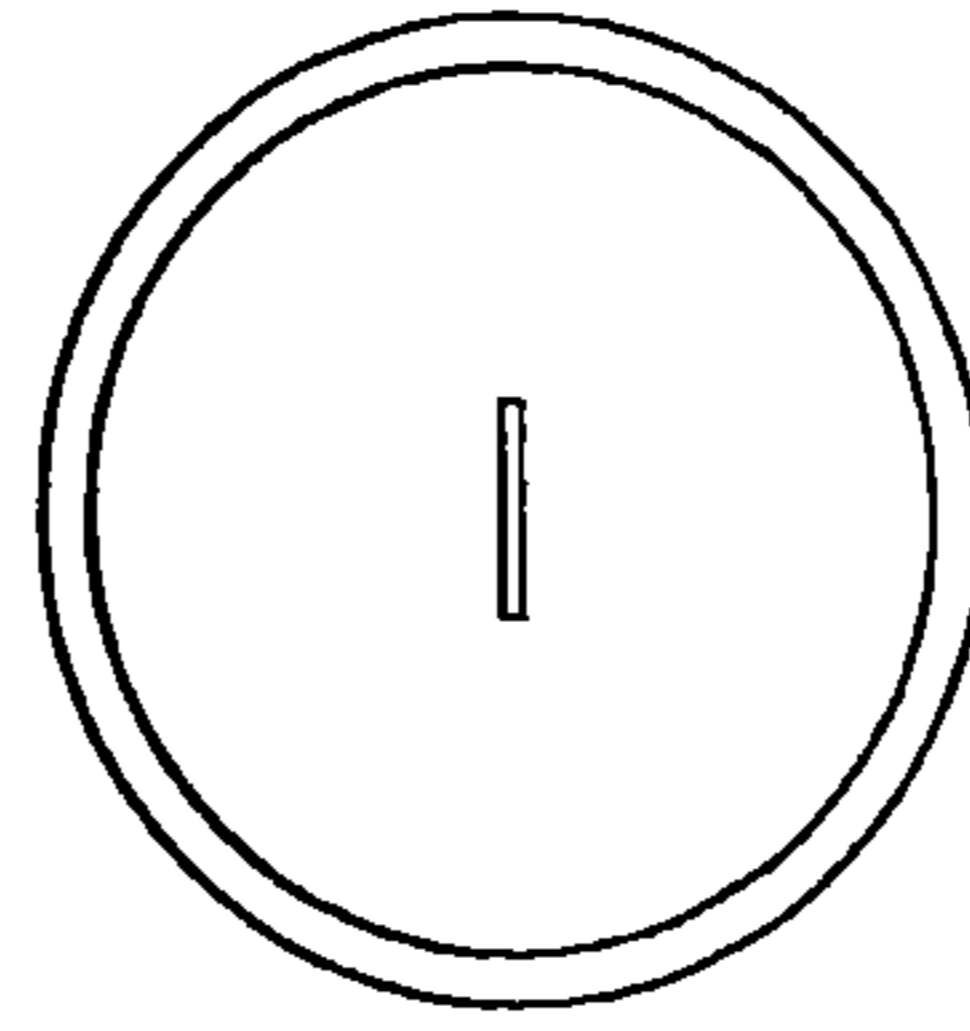

Fig. 312

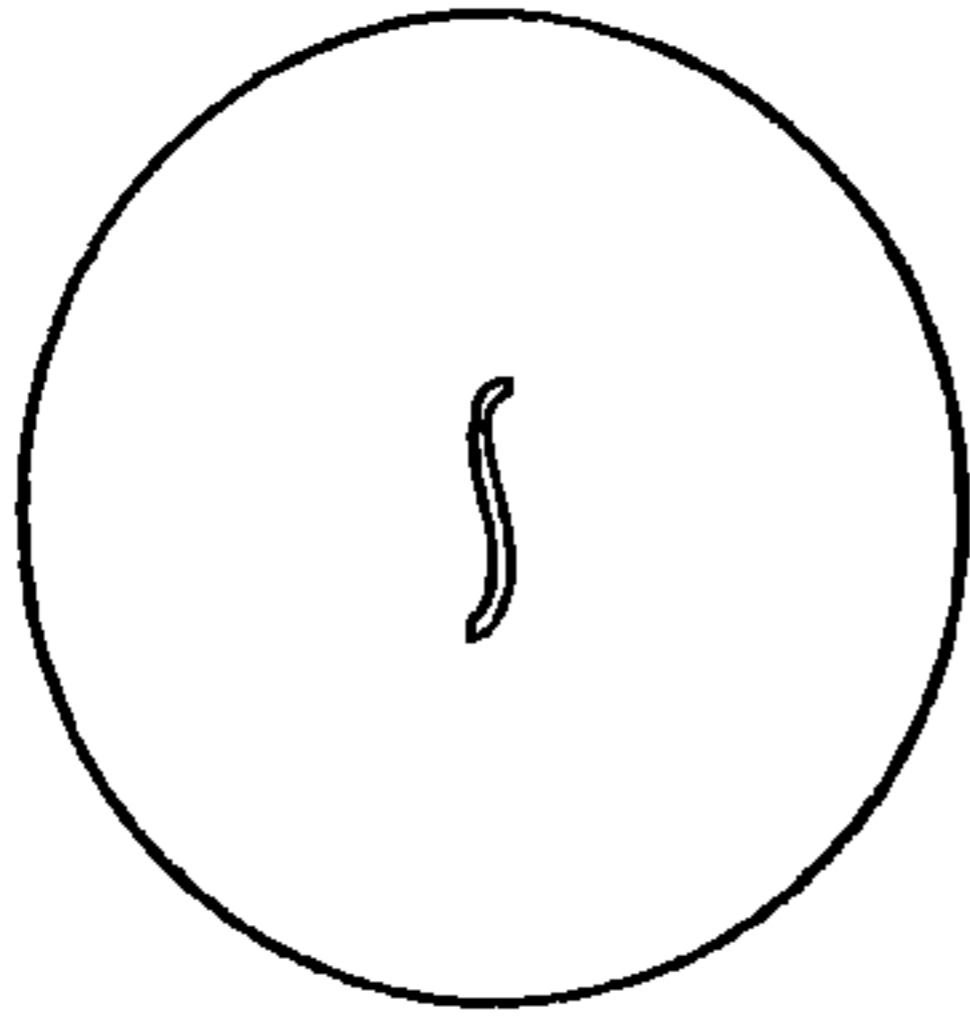

Fig. 315

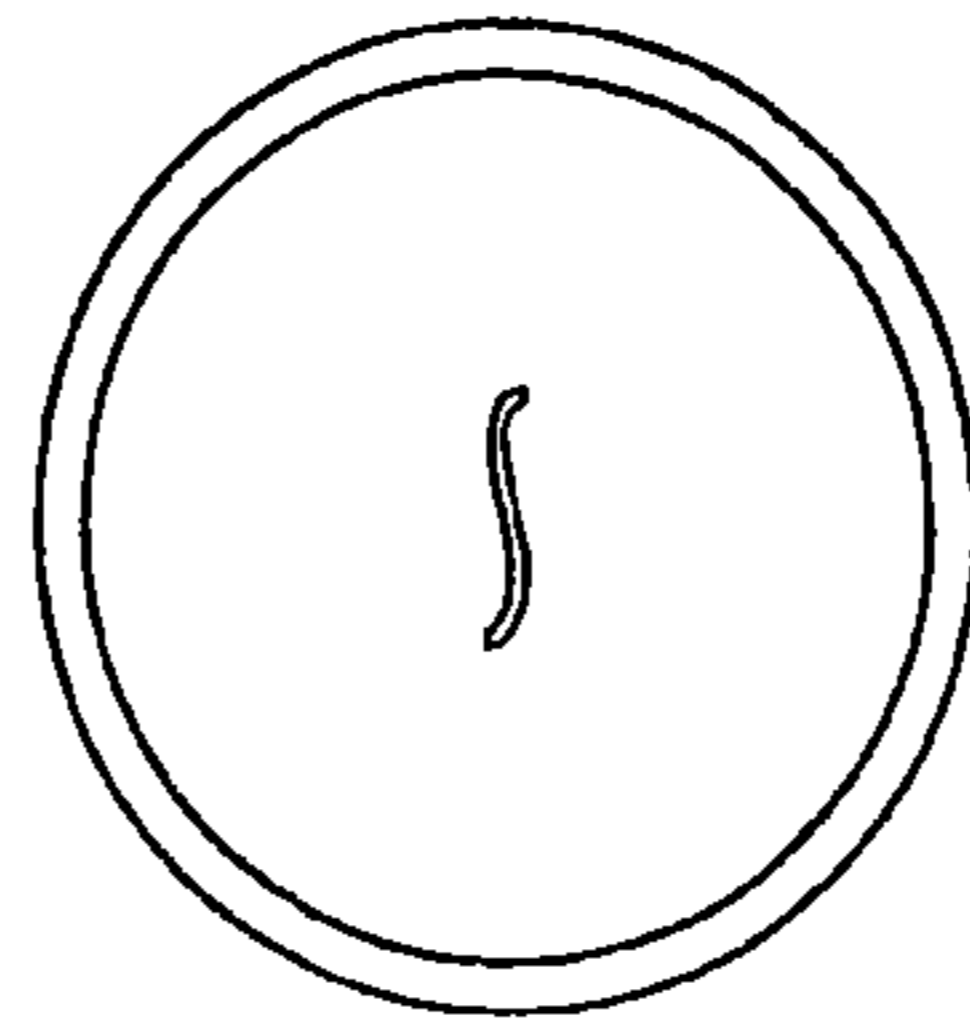

Fig. 318

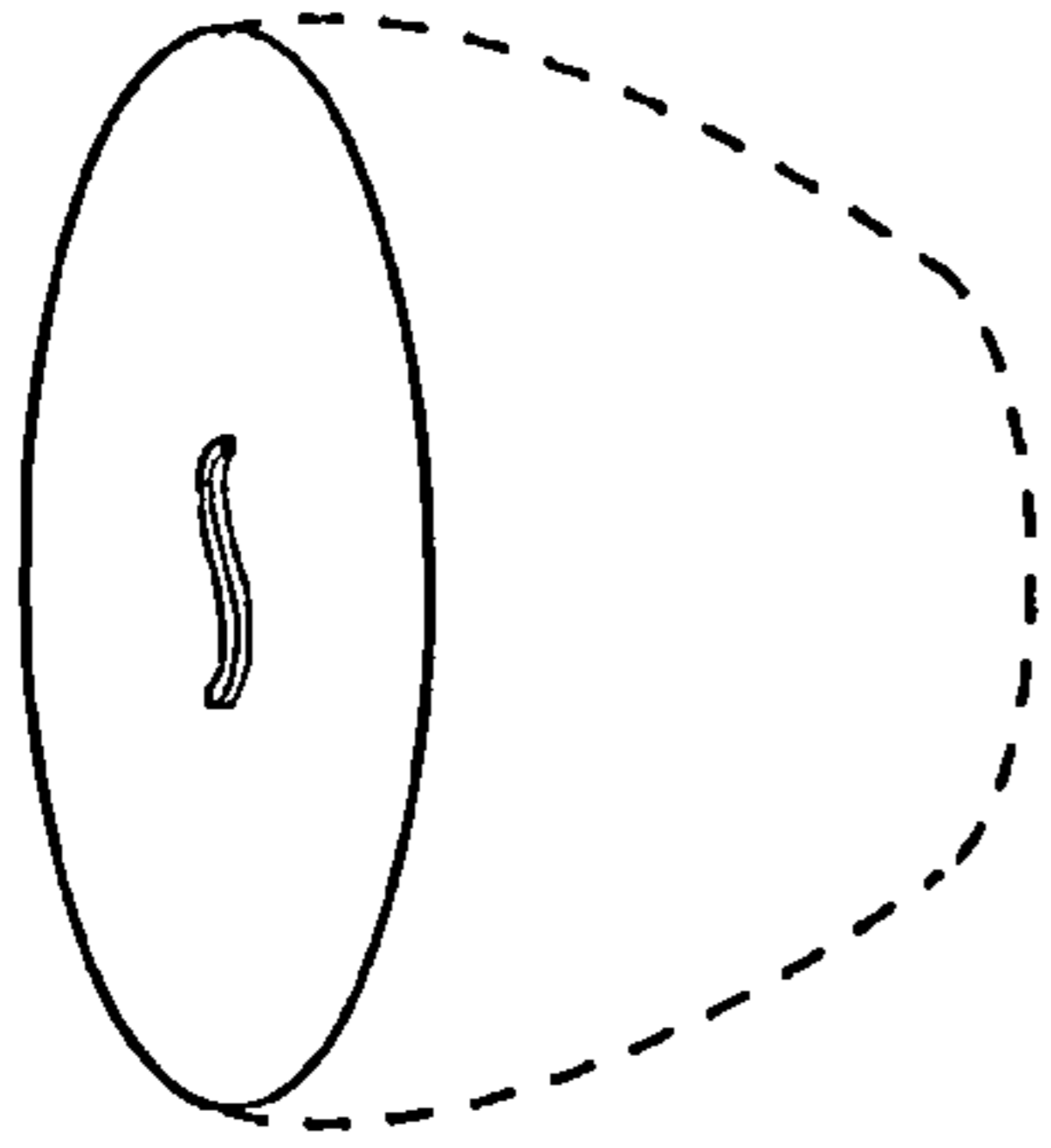

Fig. 314

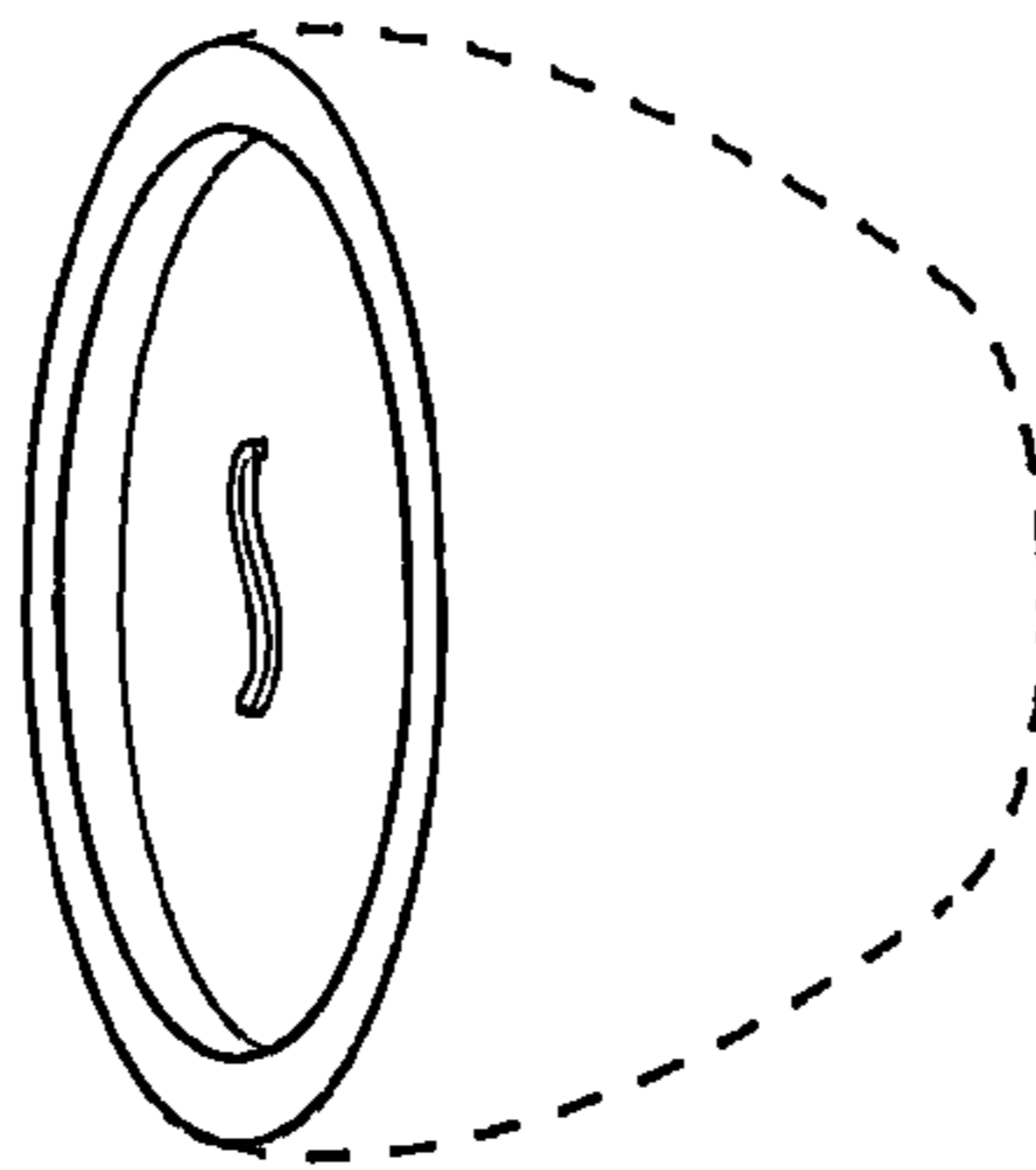

Fig. 317

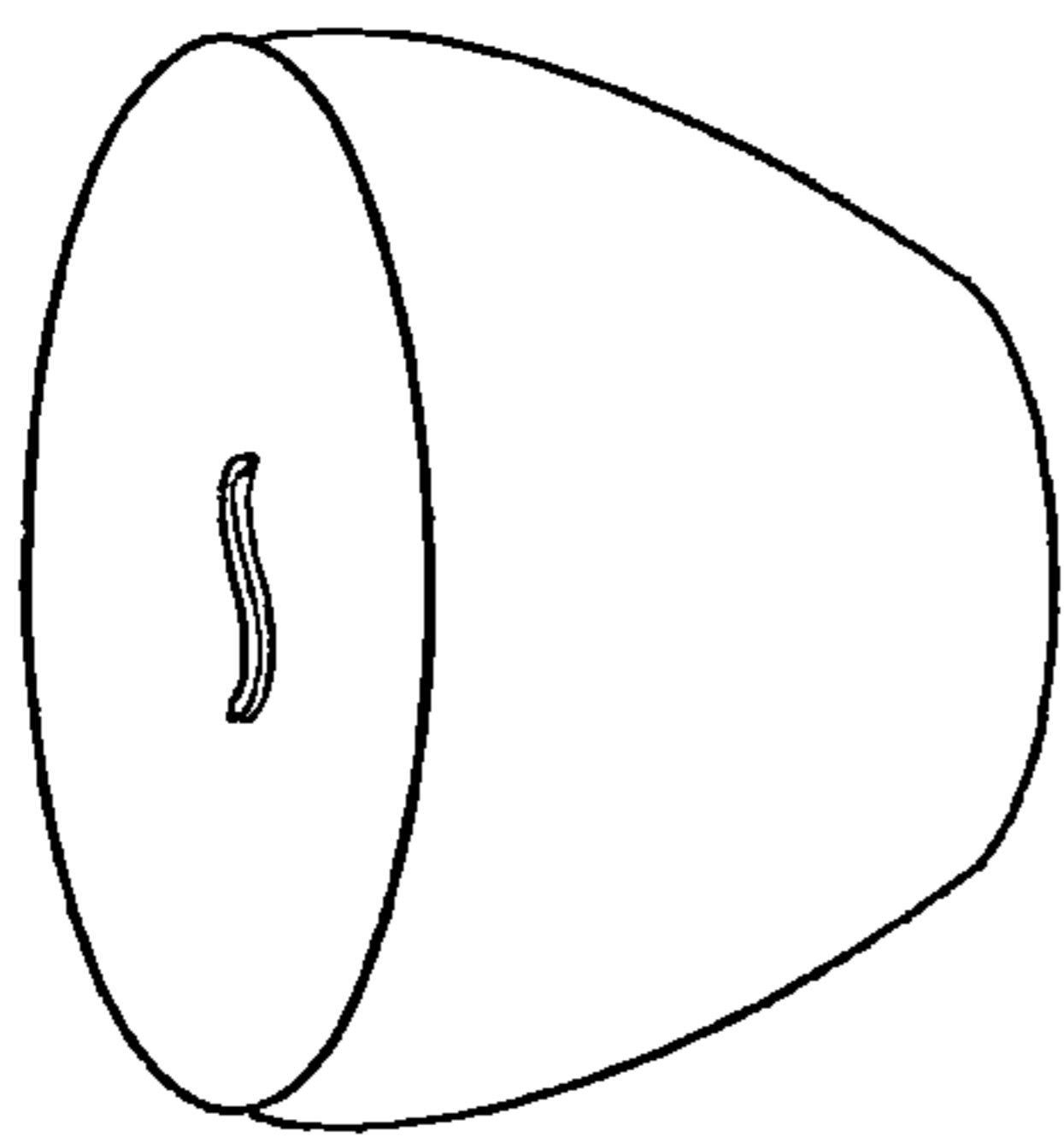

Fig. 313

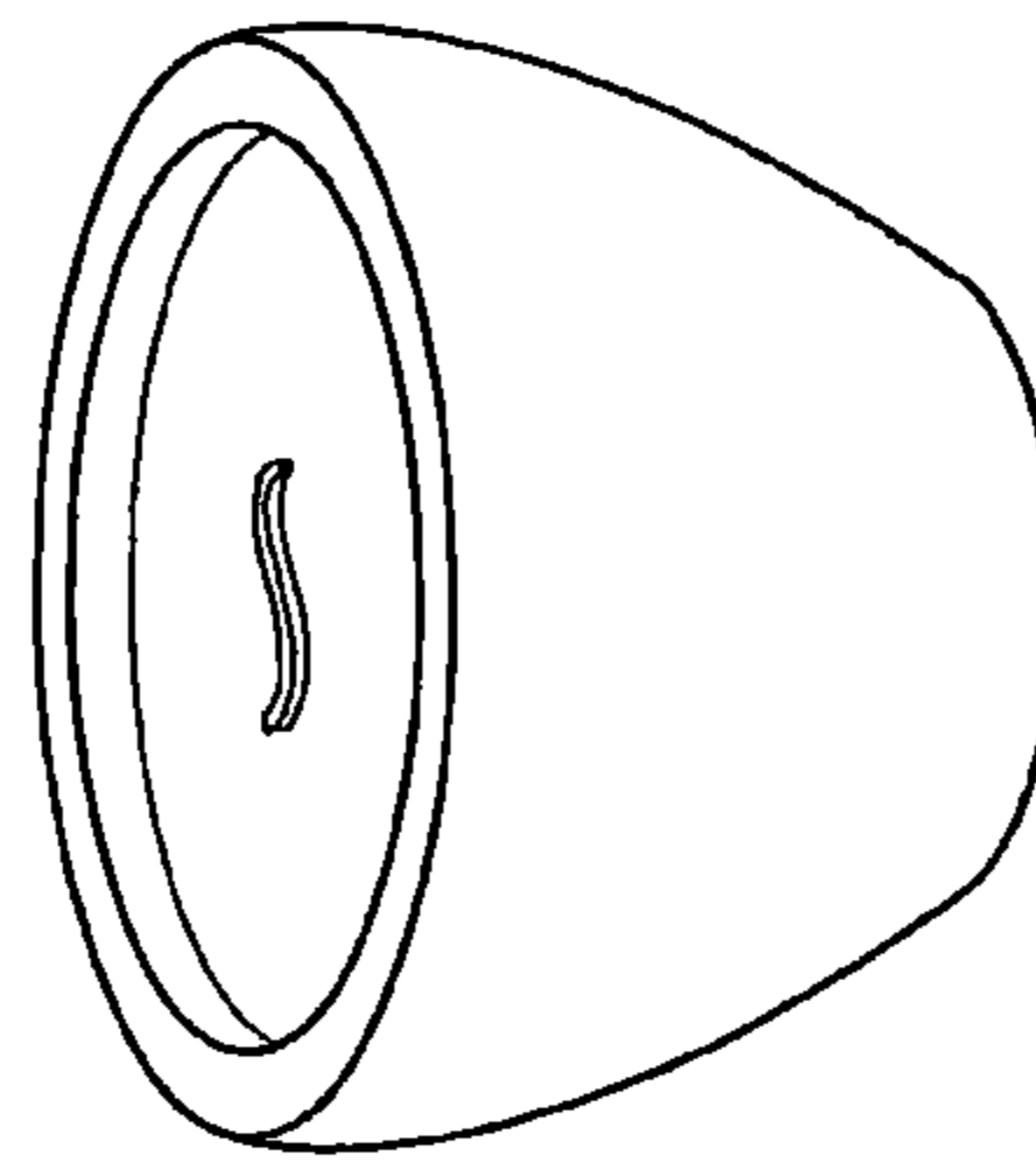

Fig. 316

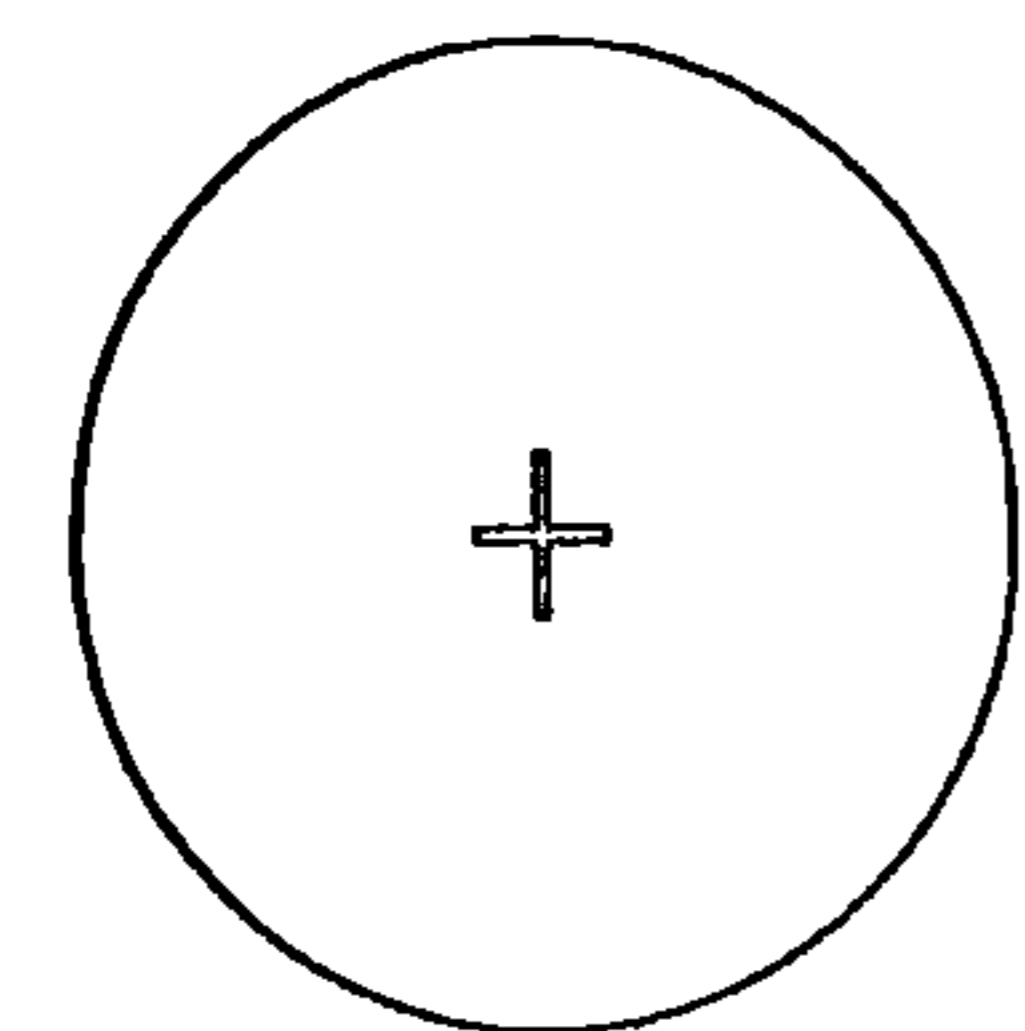

Fig. 321

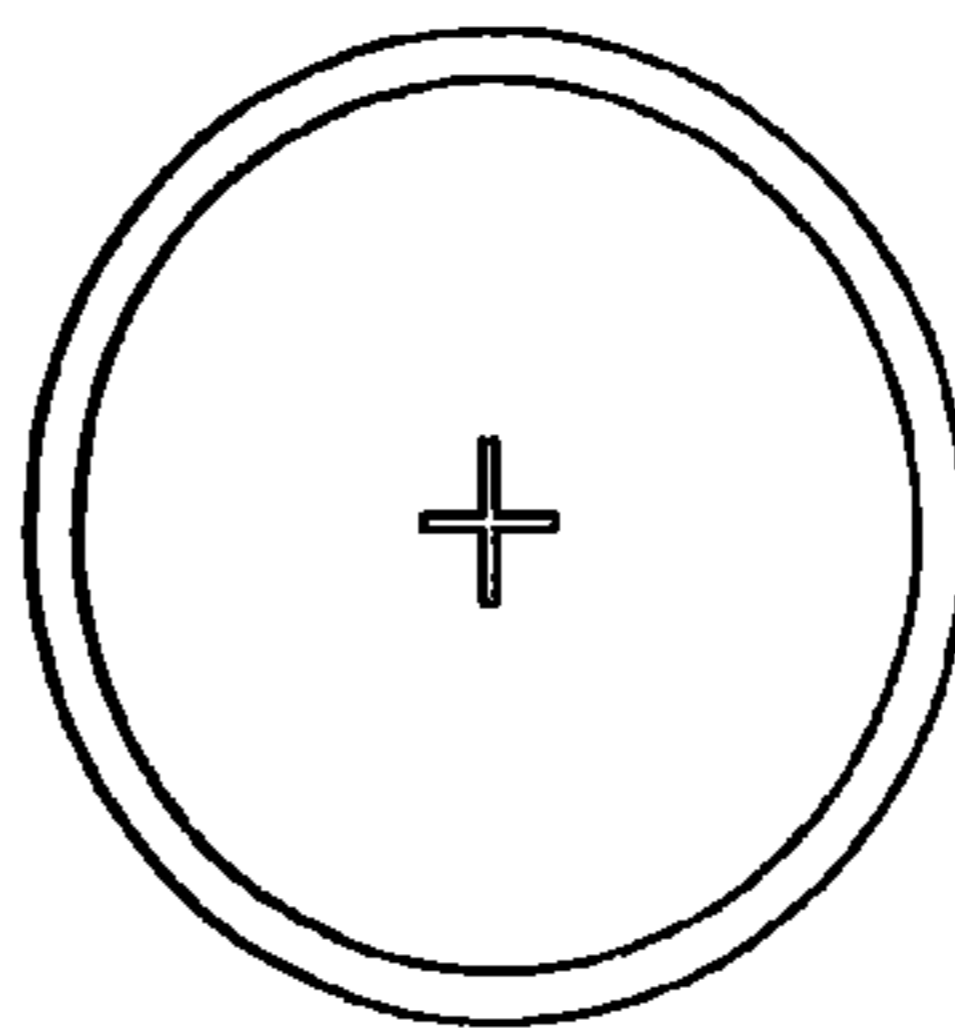

Fig. 324

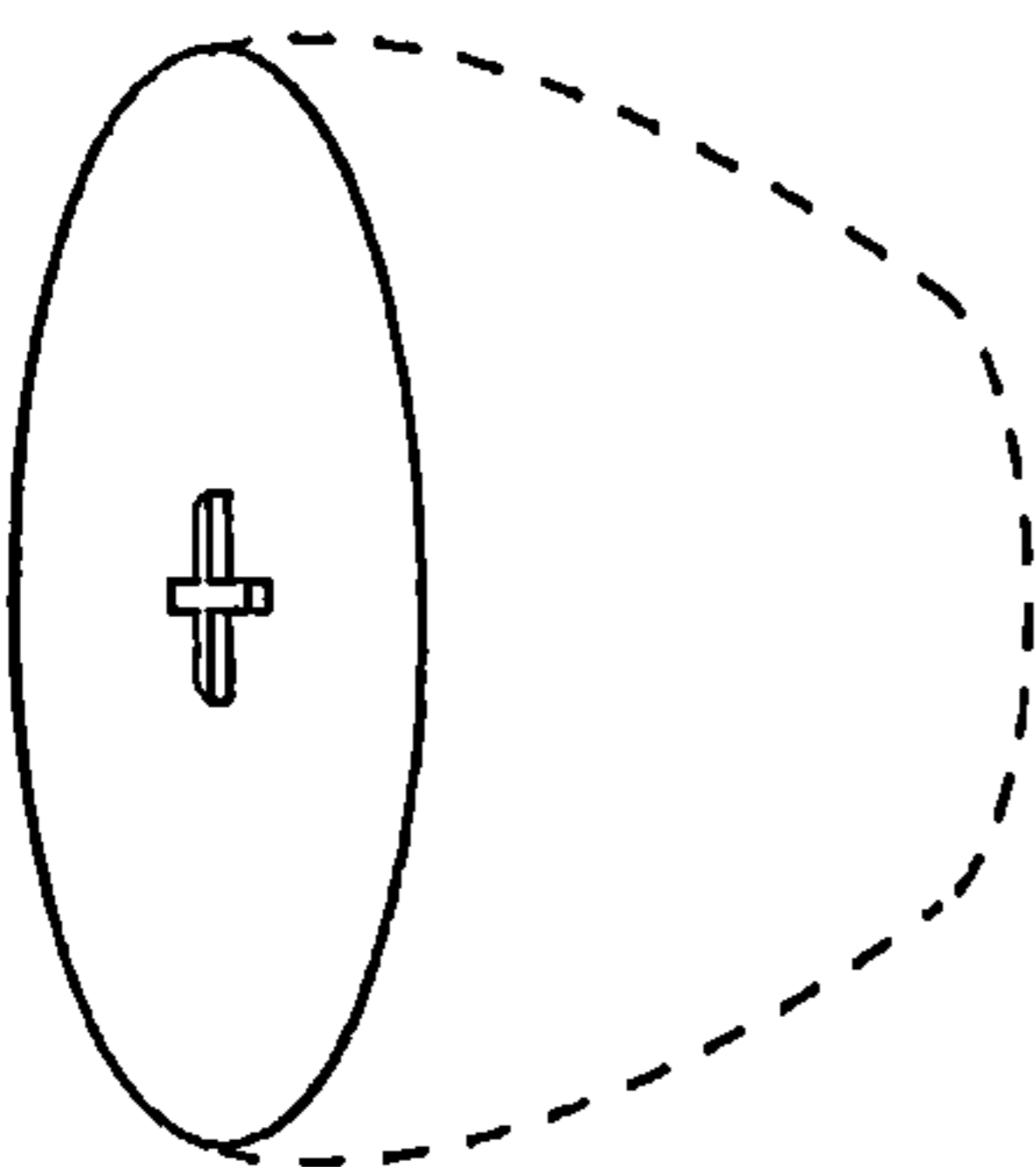

Fig. 320

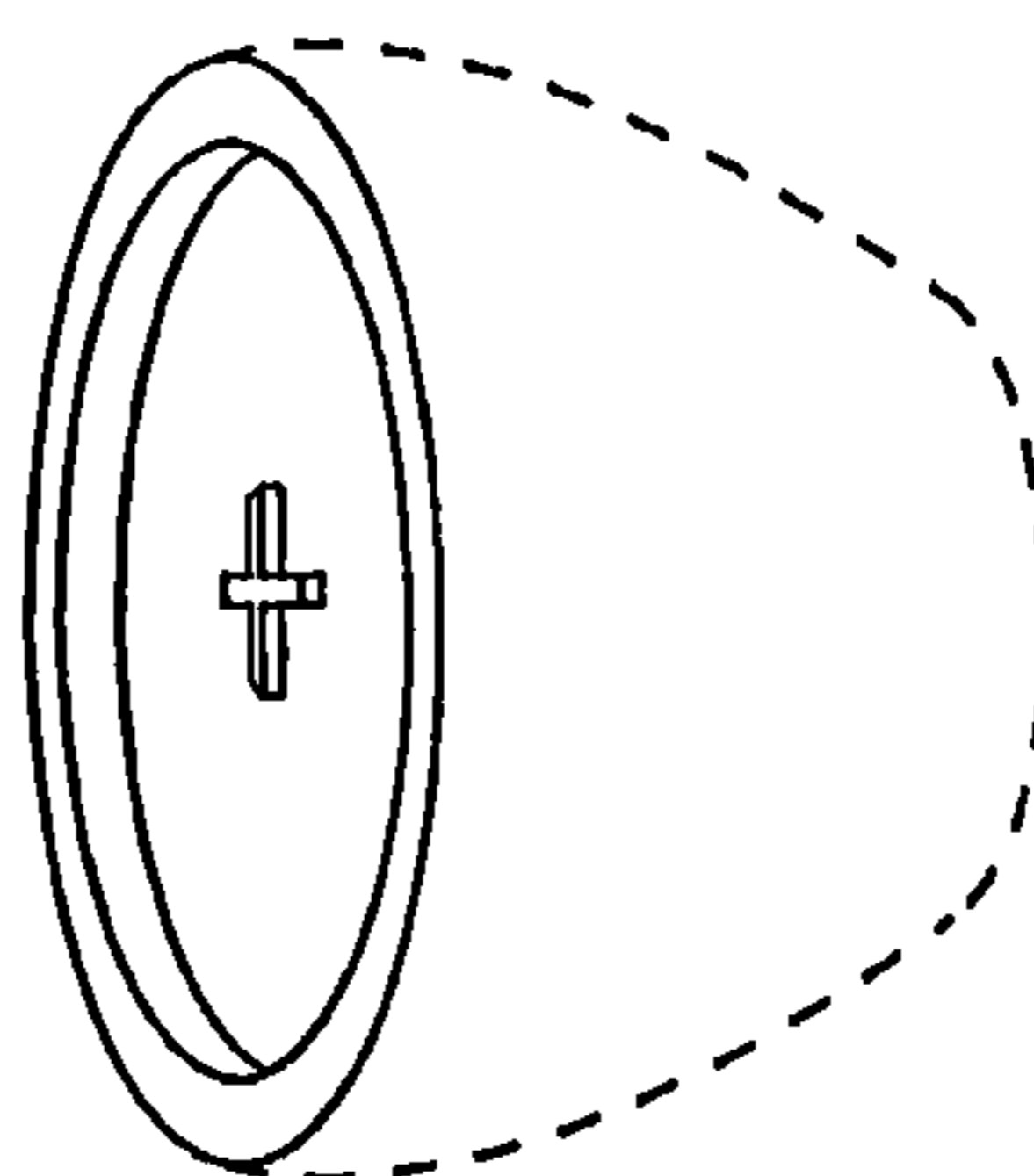

Fig. 323

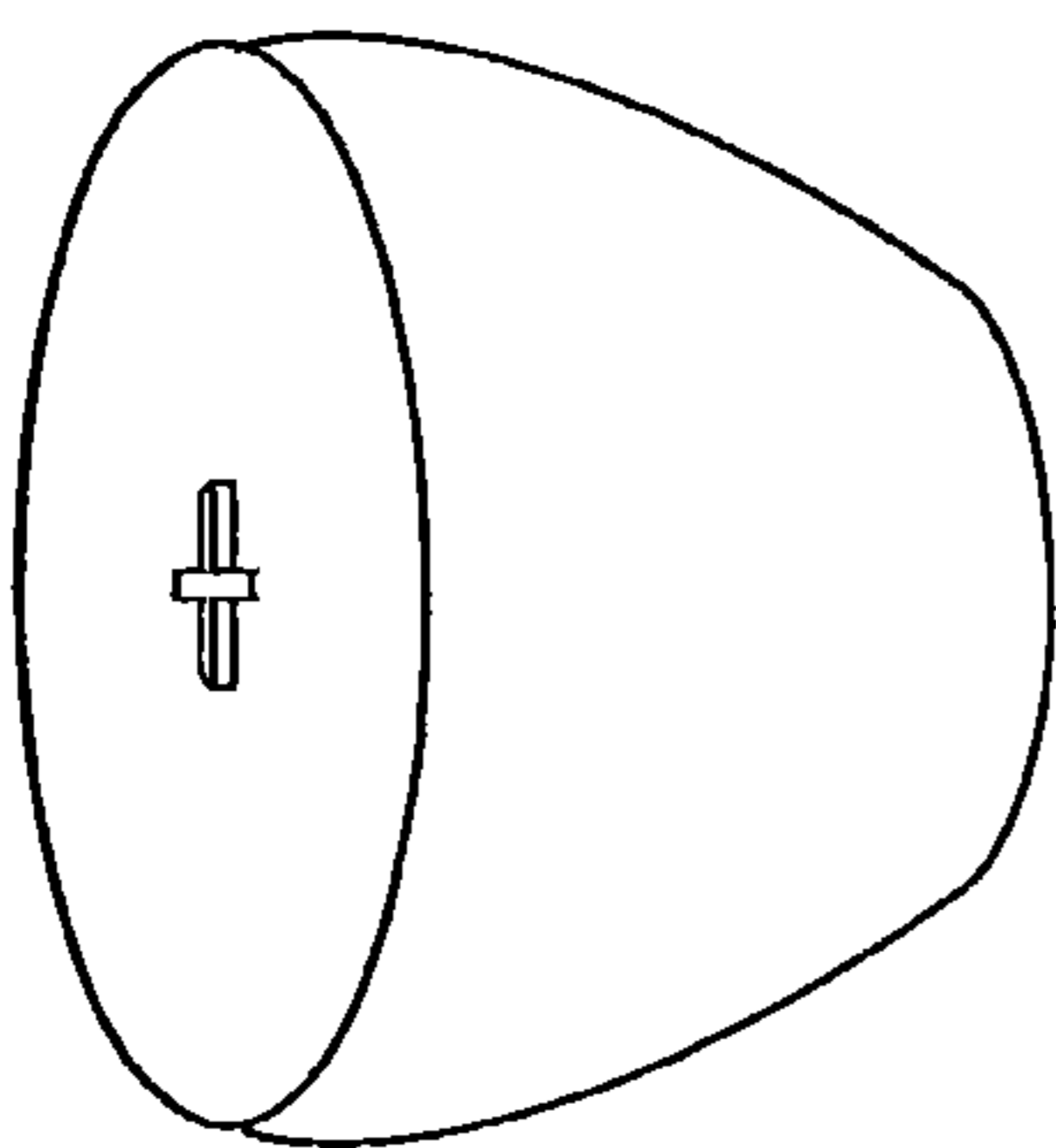

Fig. 319

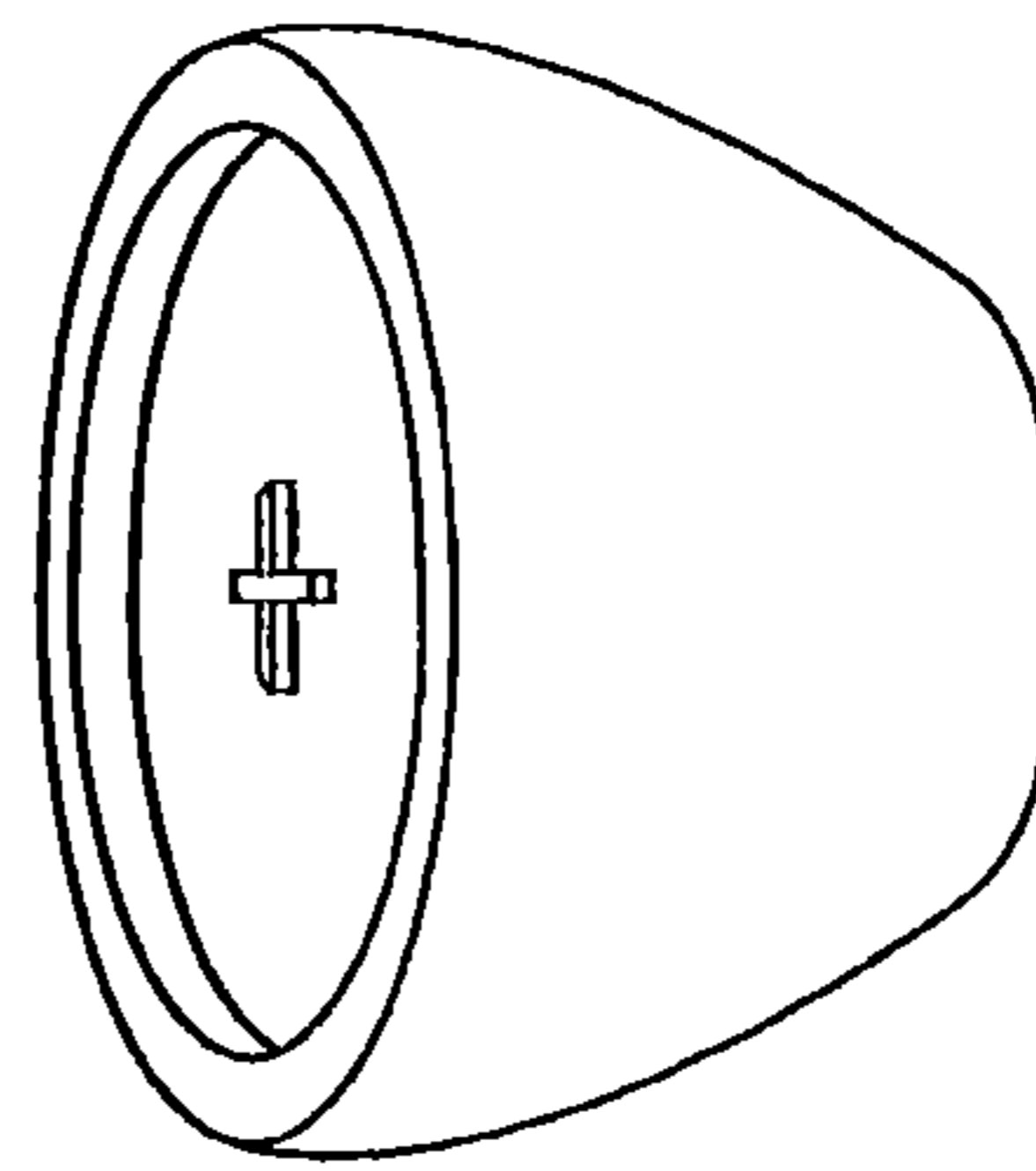

Fig. 322

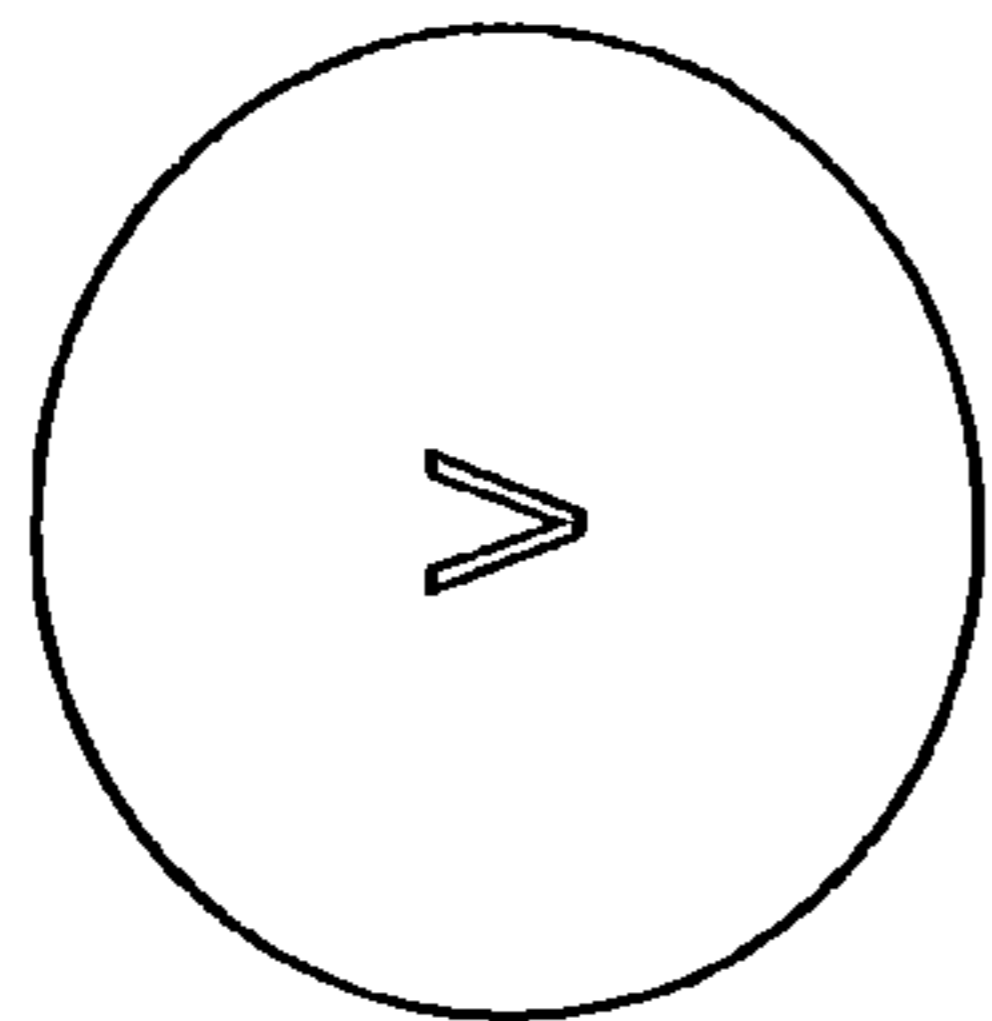

Fig. 327

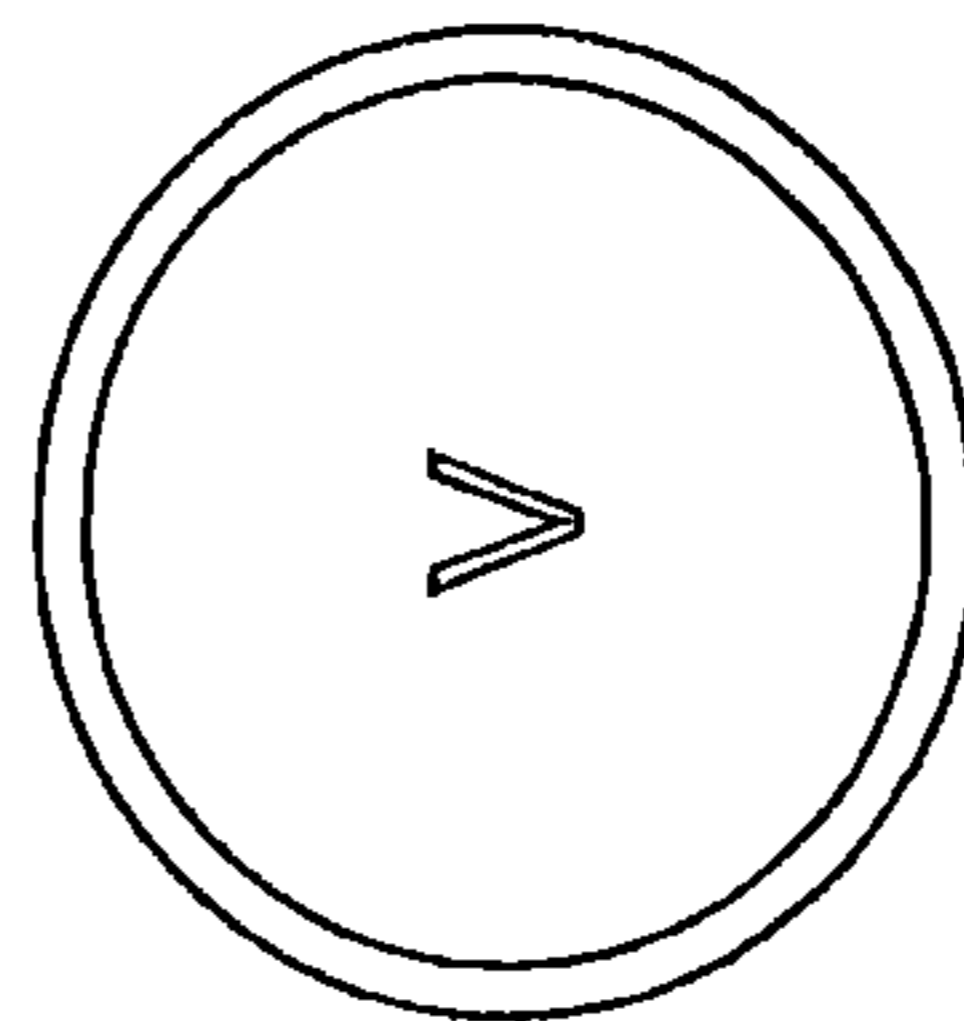

Fig. 330

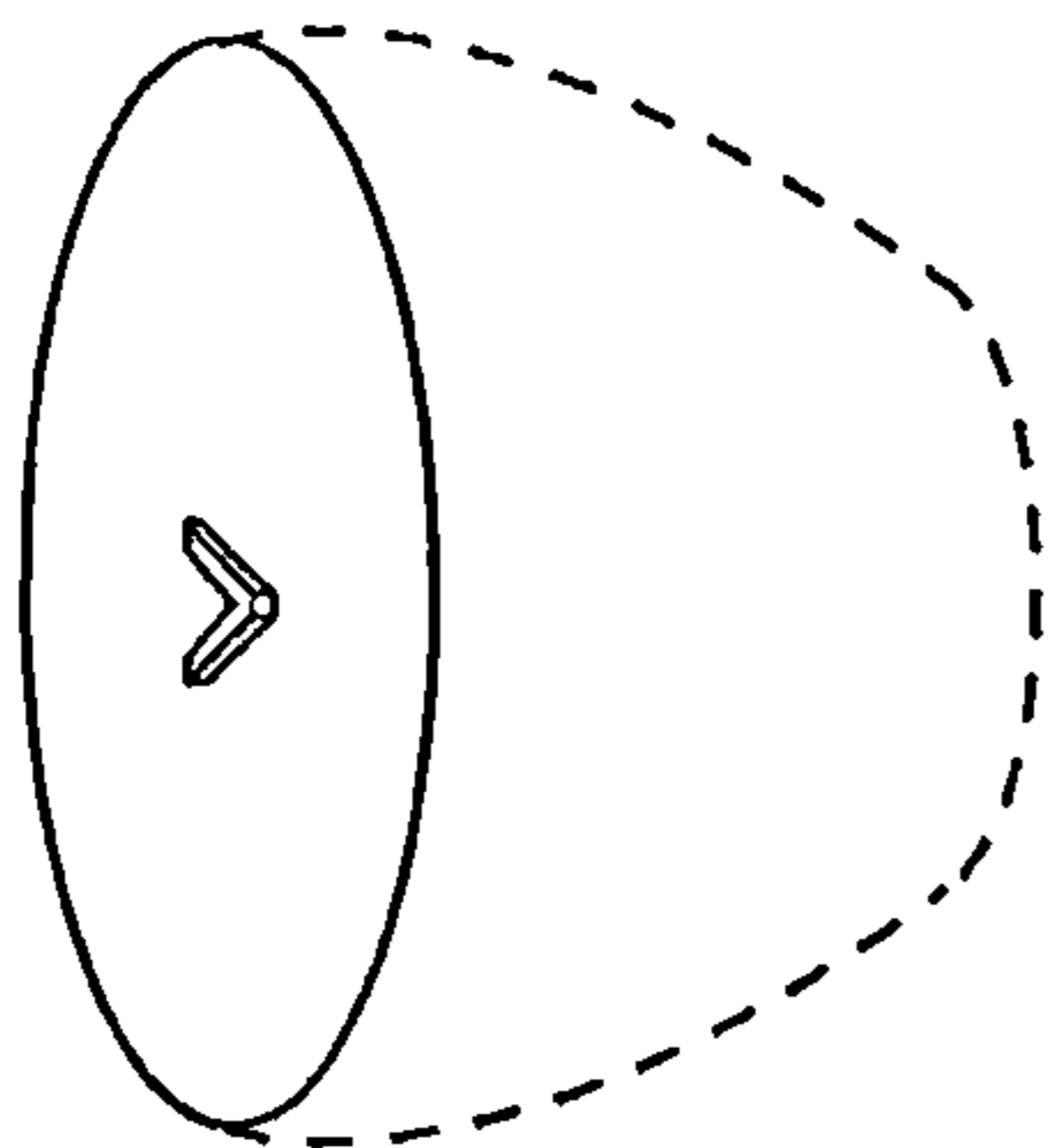

Fig. 326

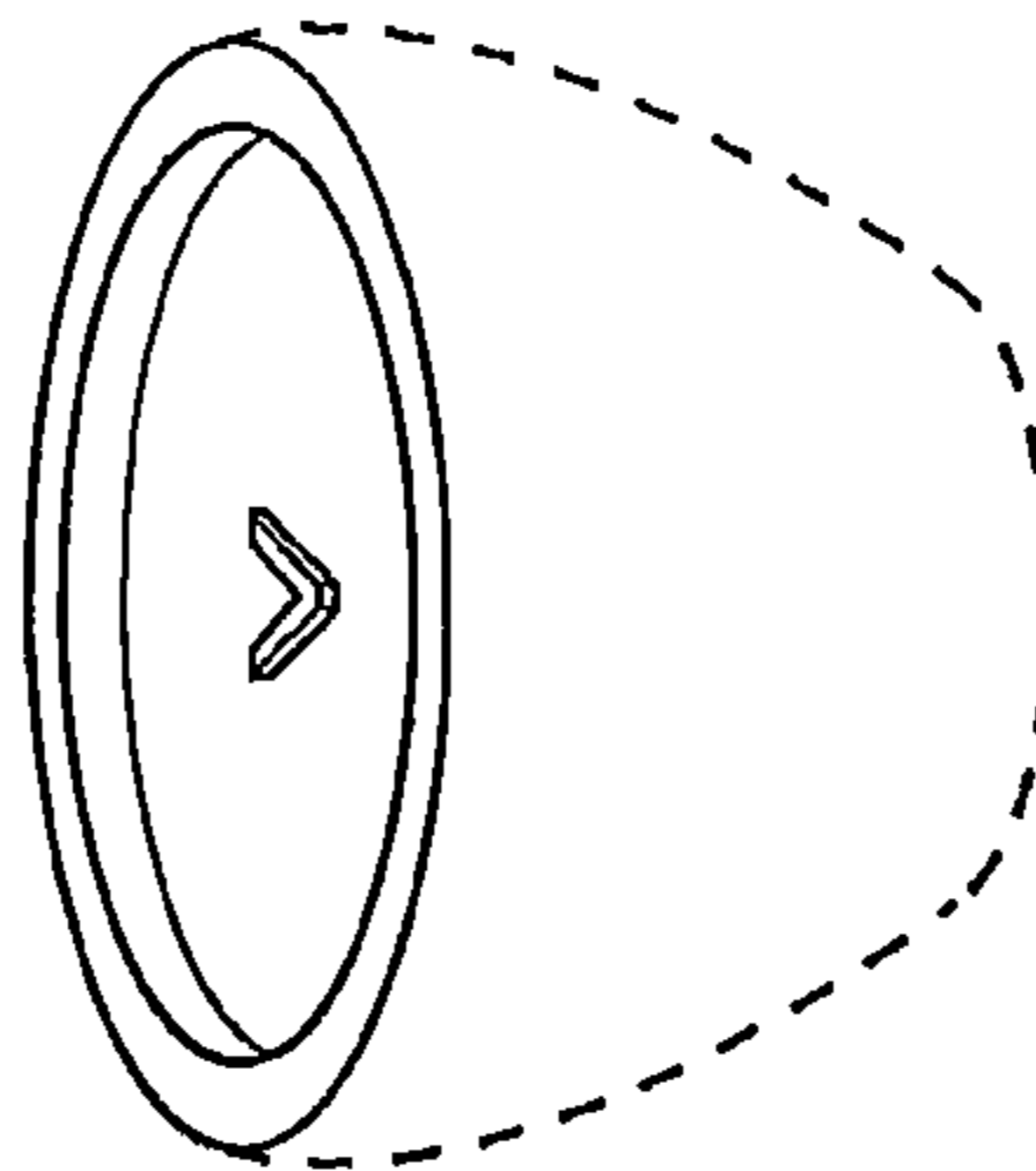

Fig. 329

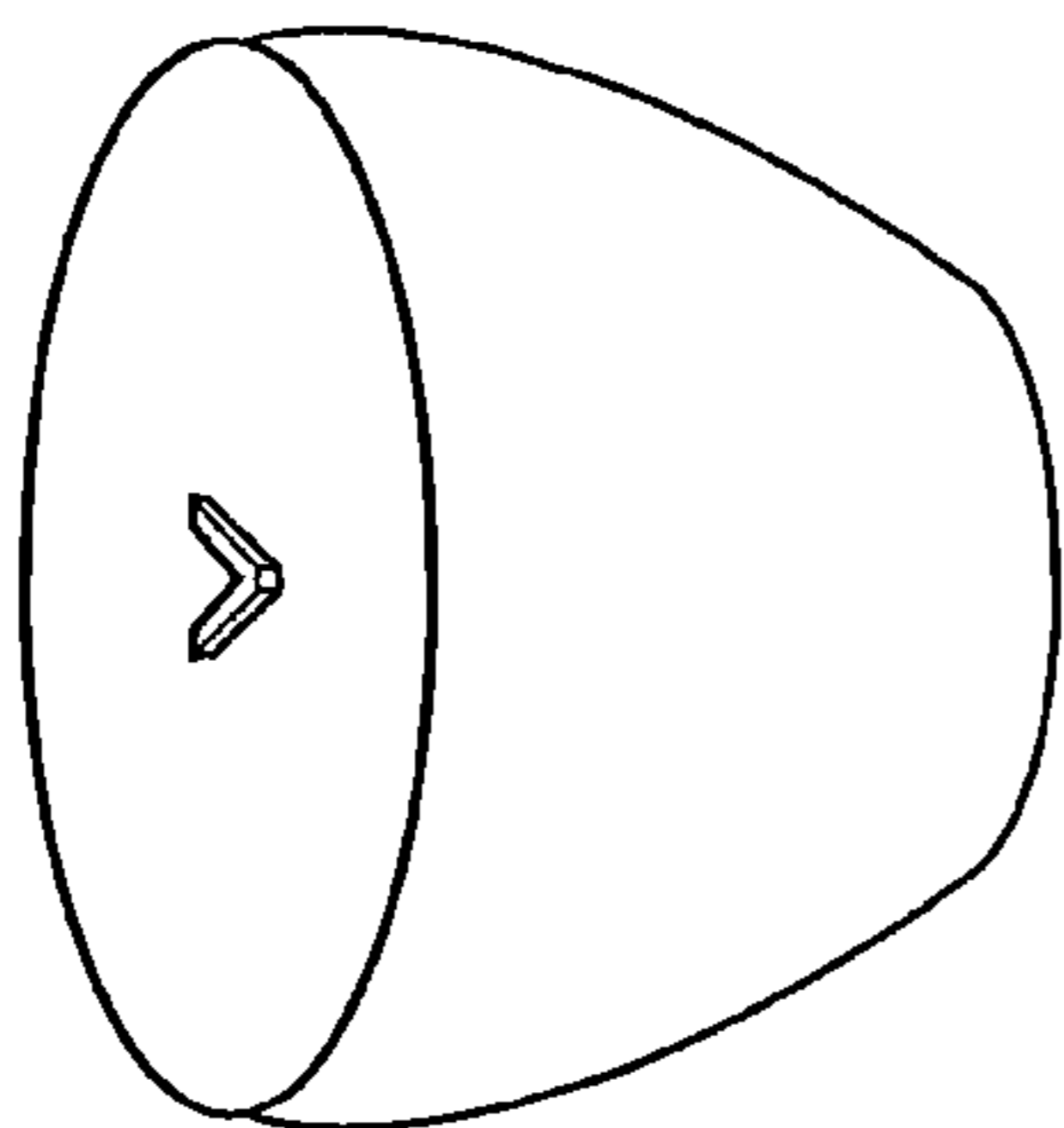

Fig. 325

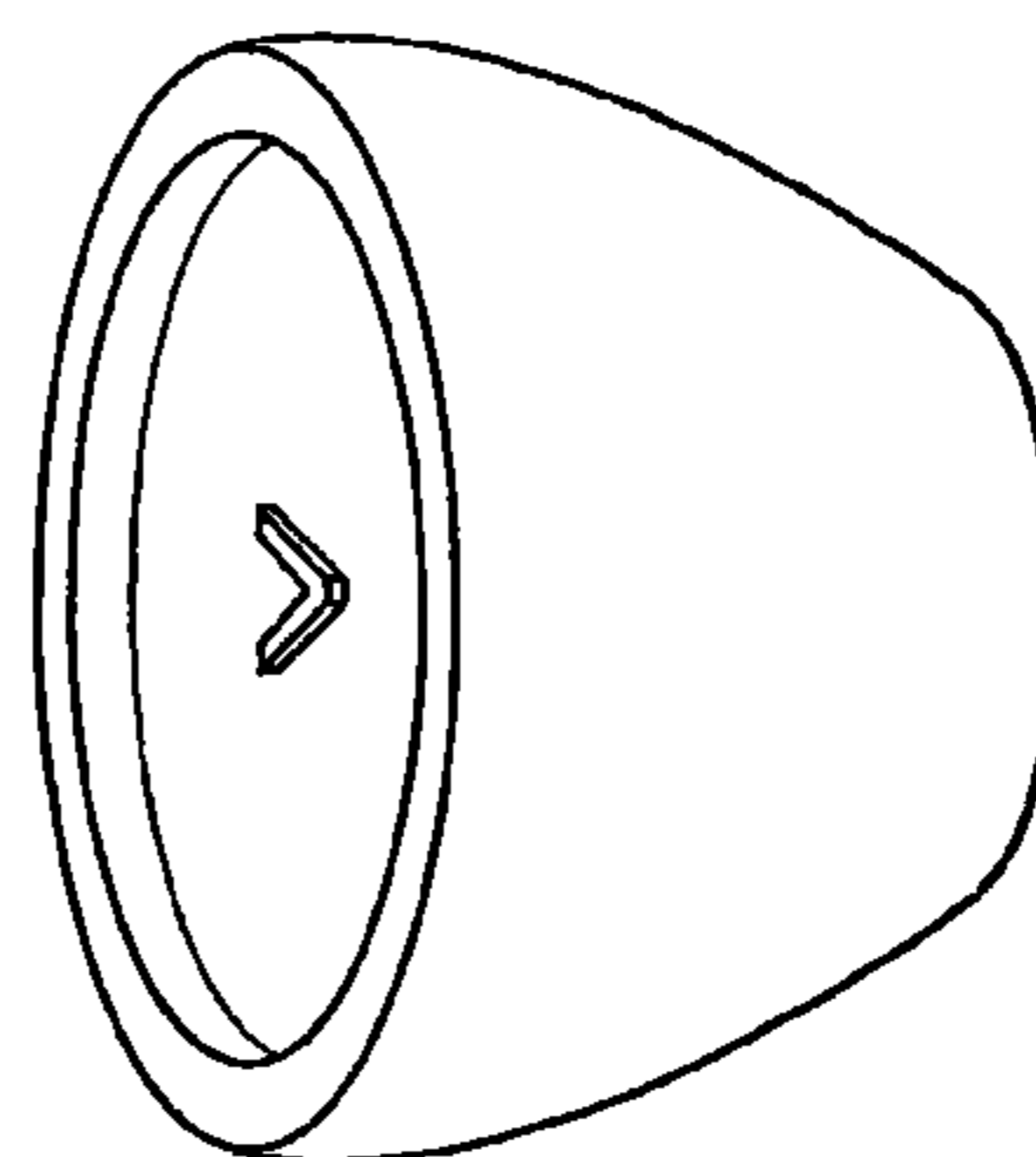

Fig. 328

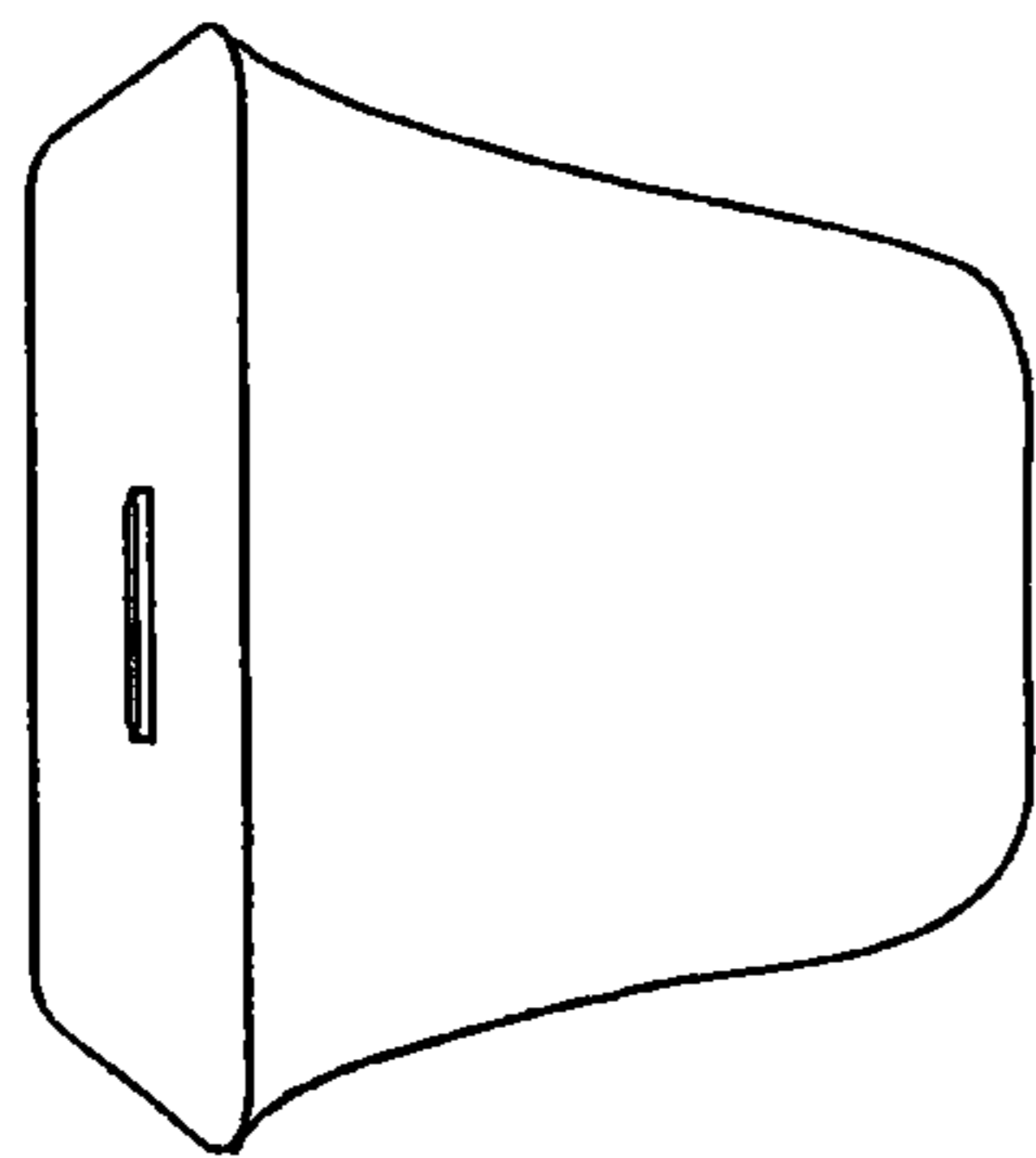

Fig. 331

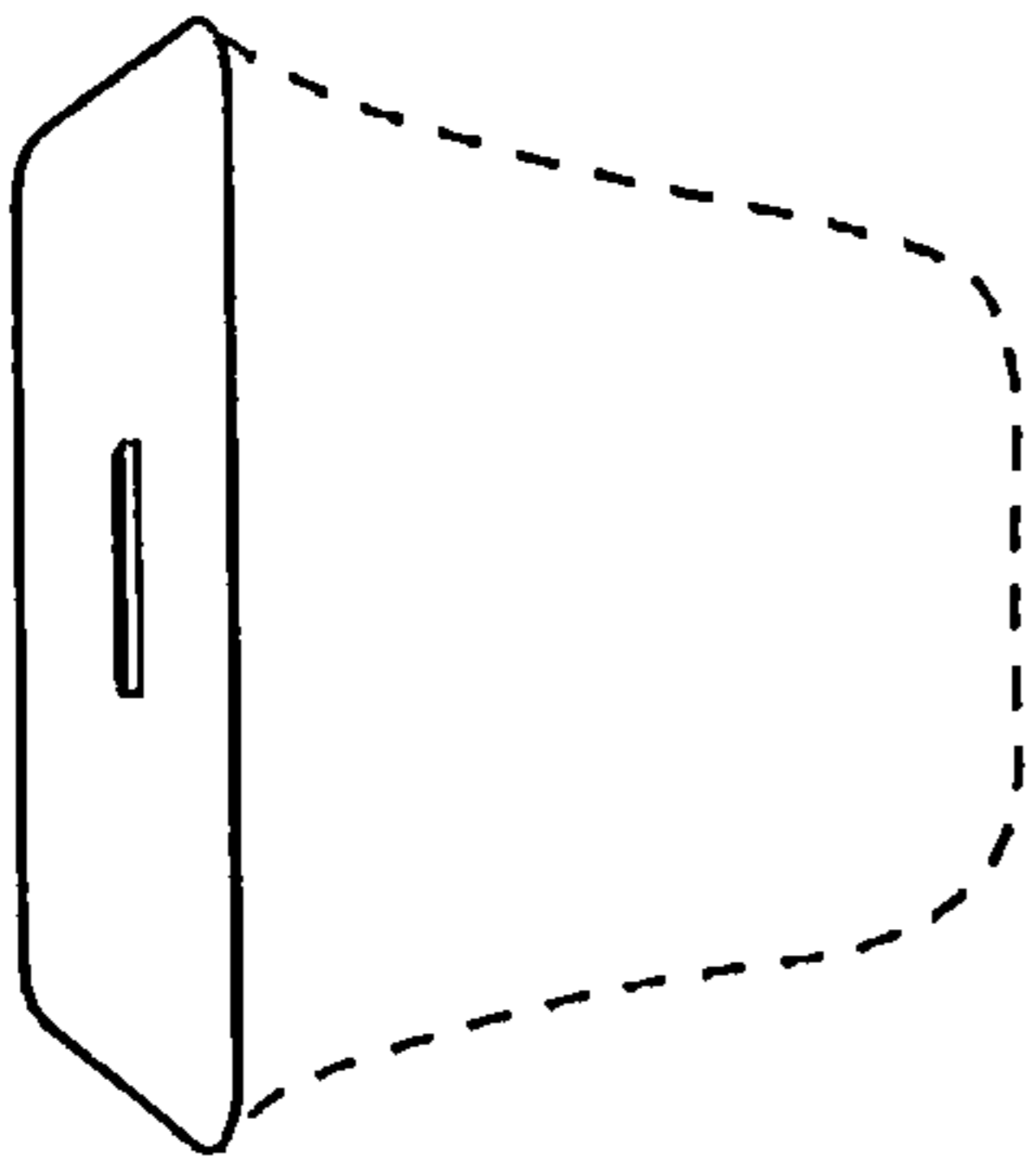

Fig. 332

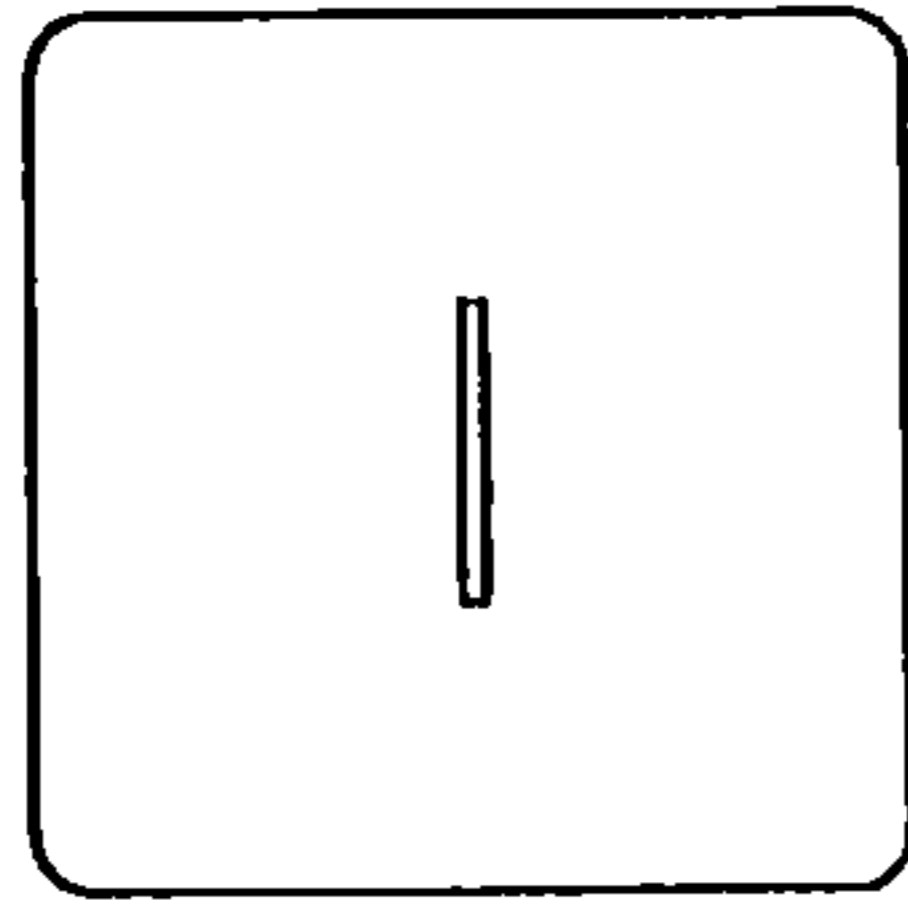

Fig. 333

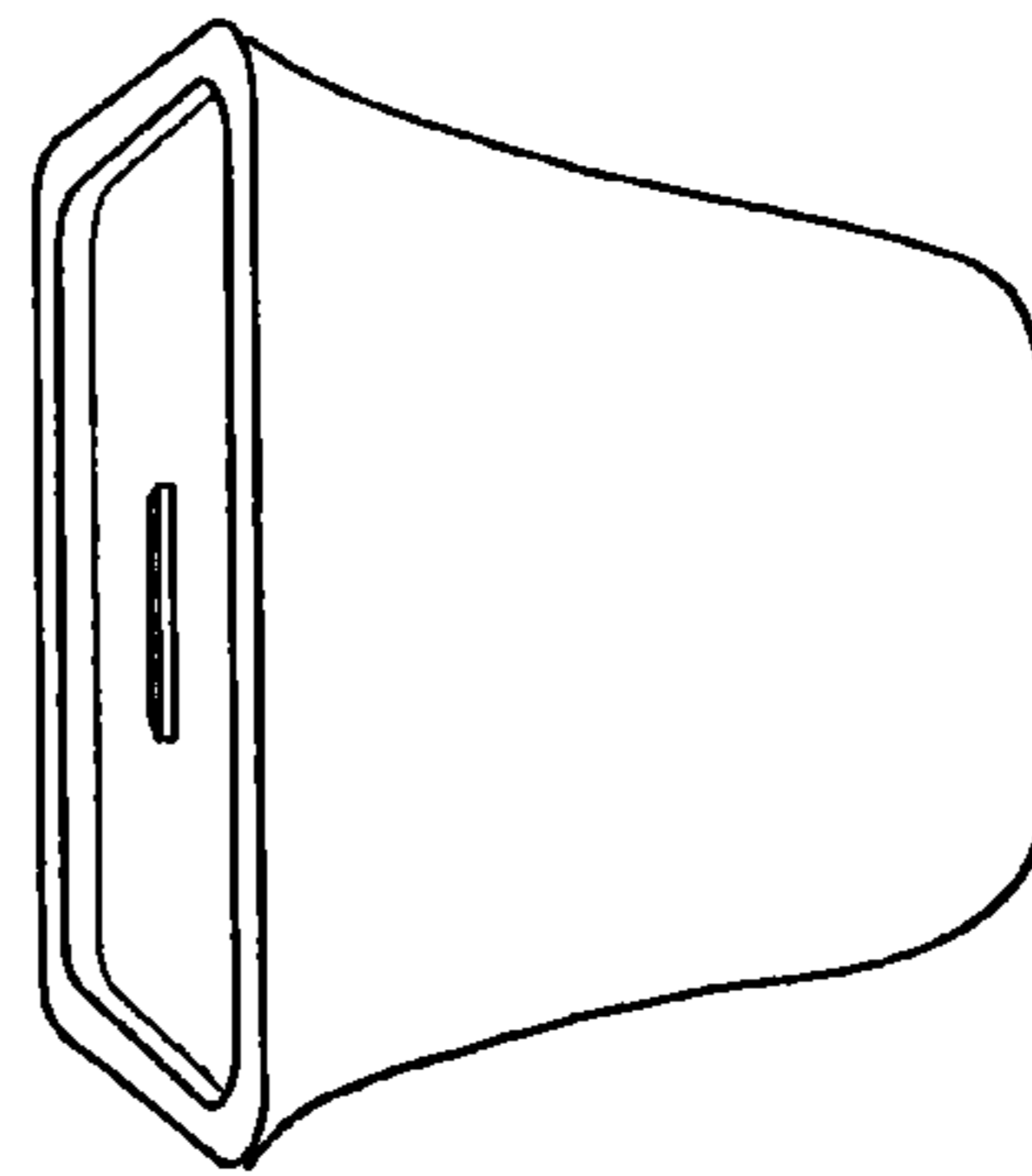

Fig. 334

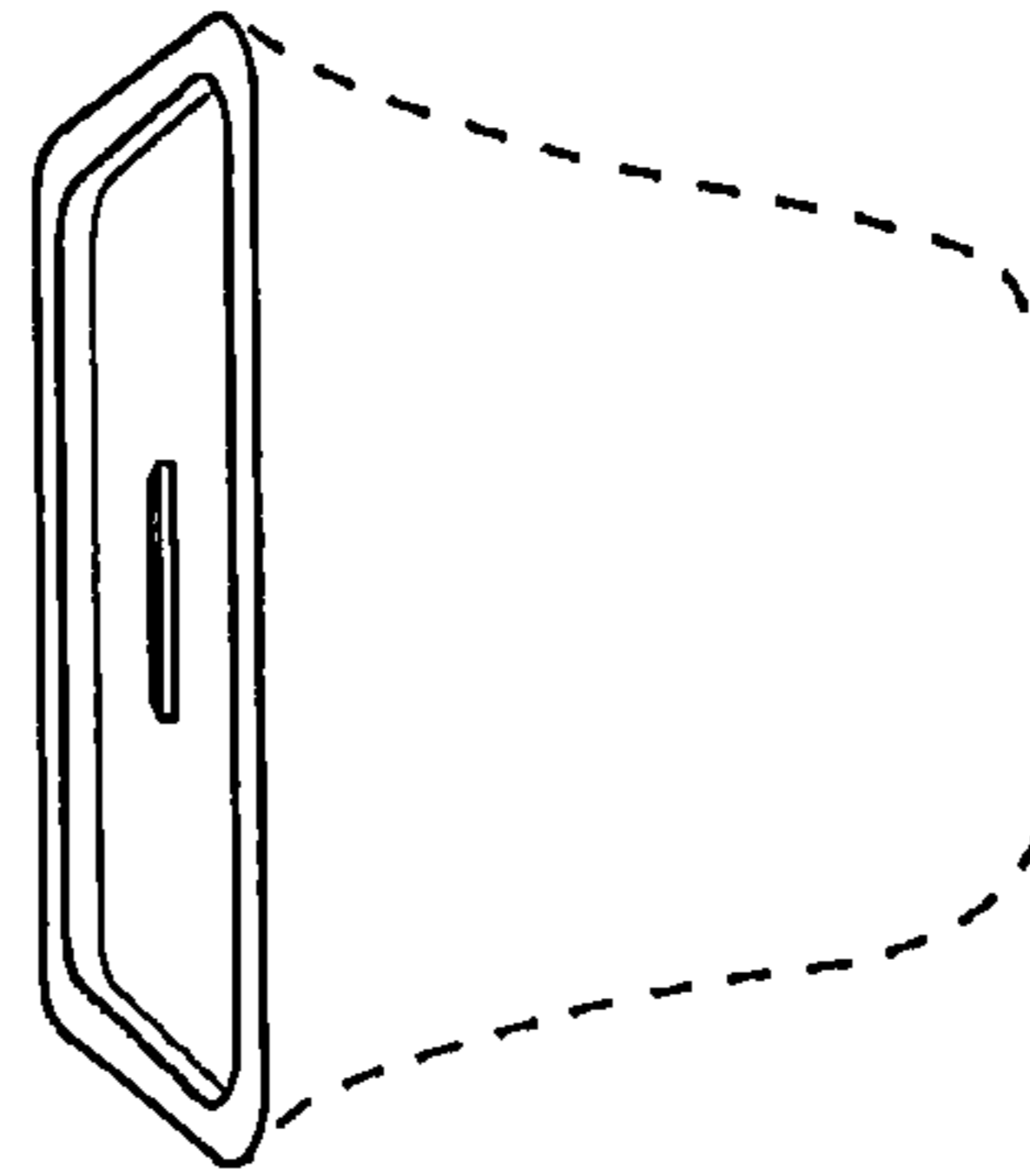

Fig. 335

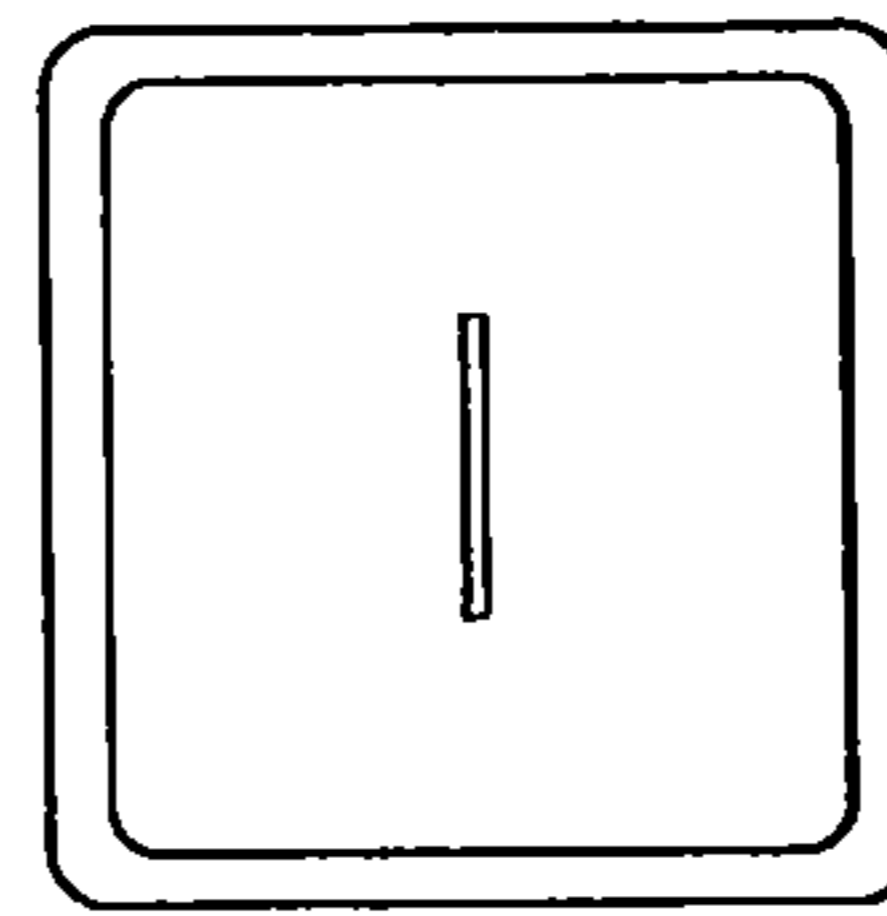

Fig. 336

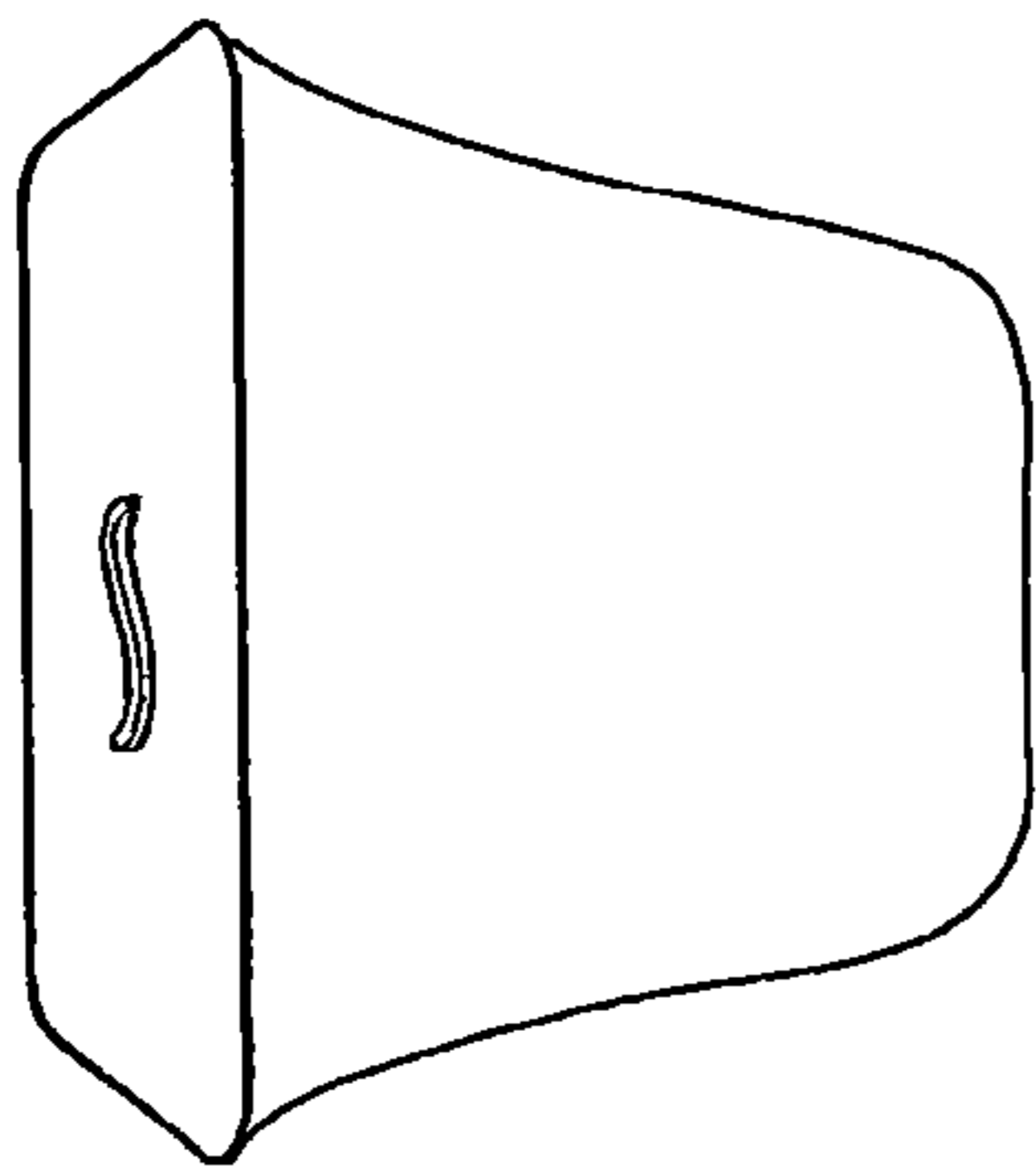

Fig. 337

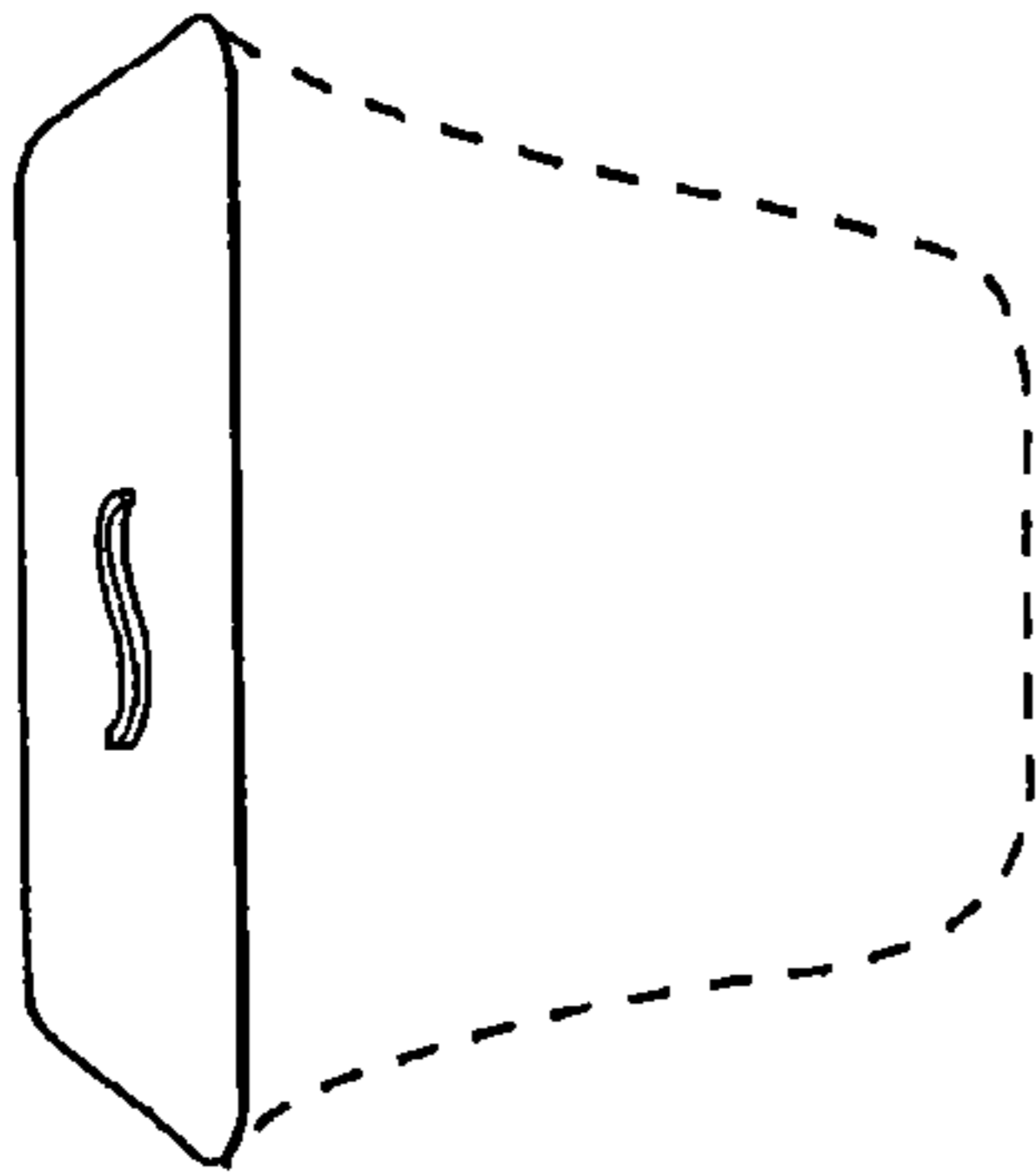

Fig. 338

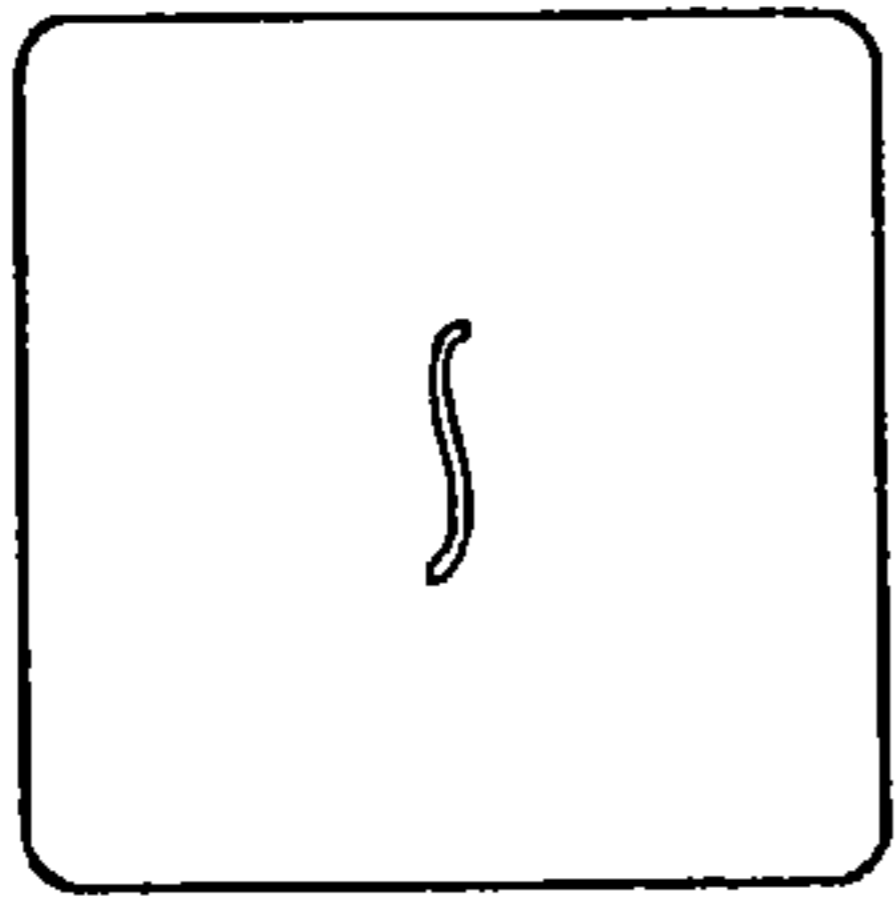

Fig. 339

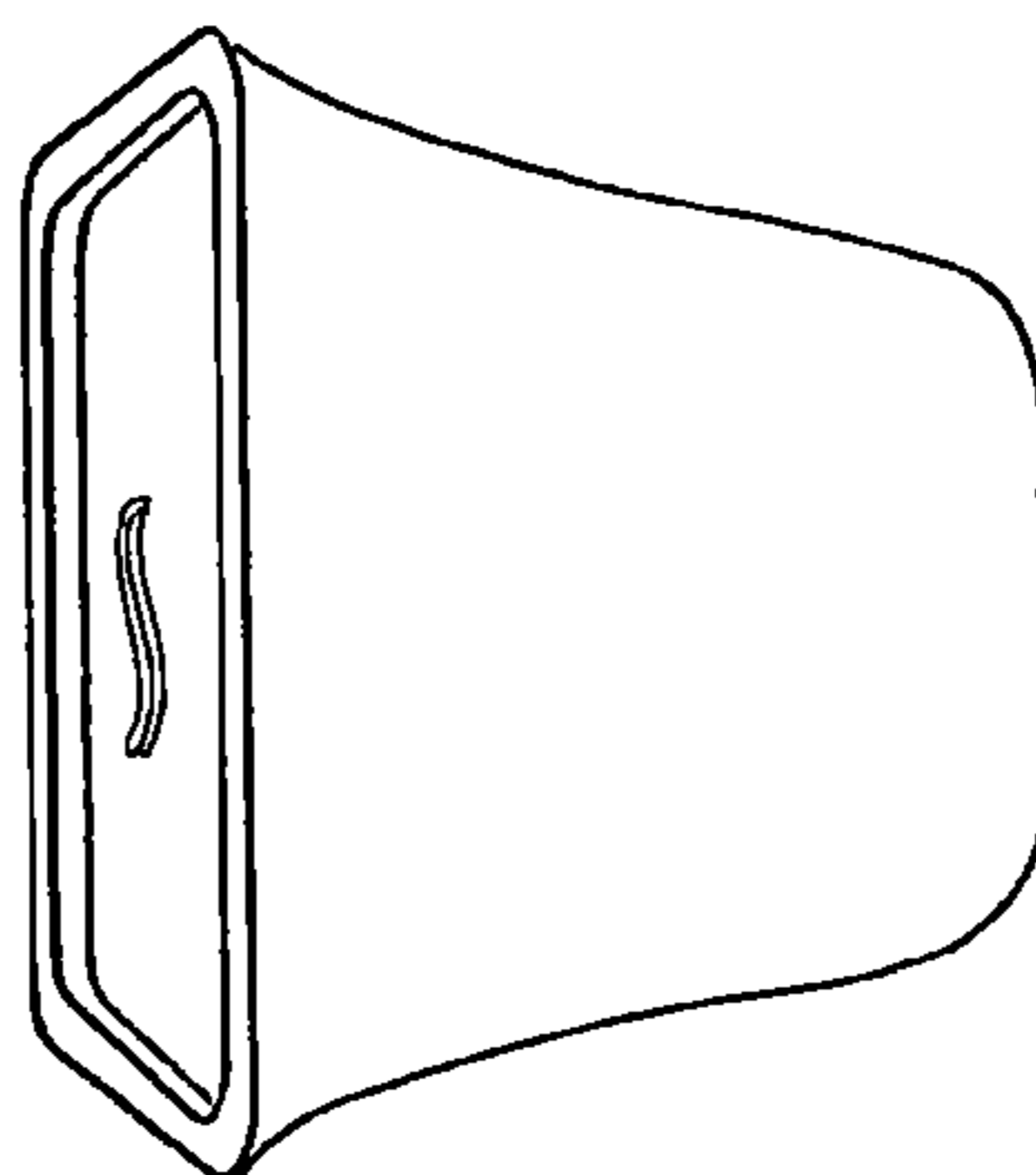

Fig. 340

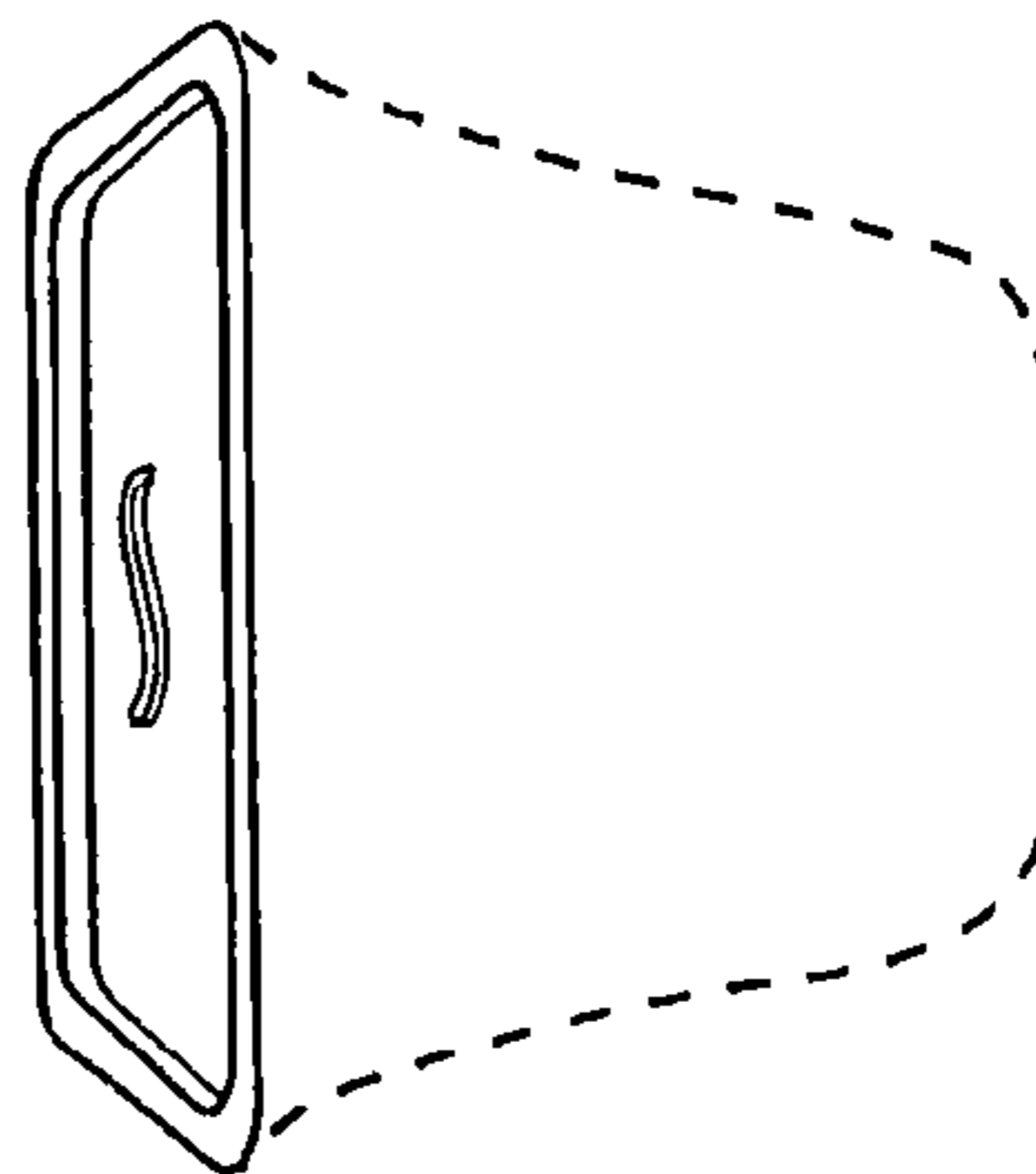

Fig. 341

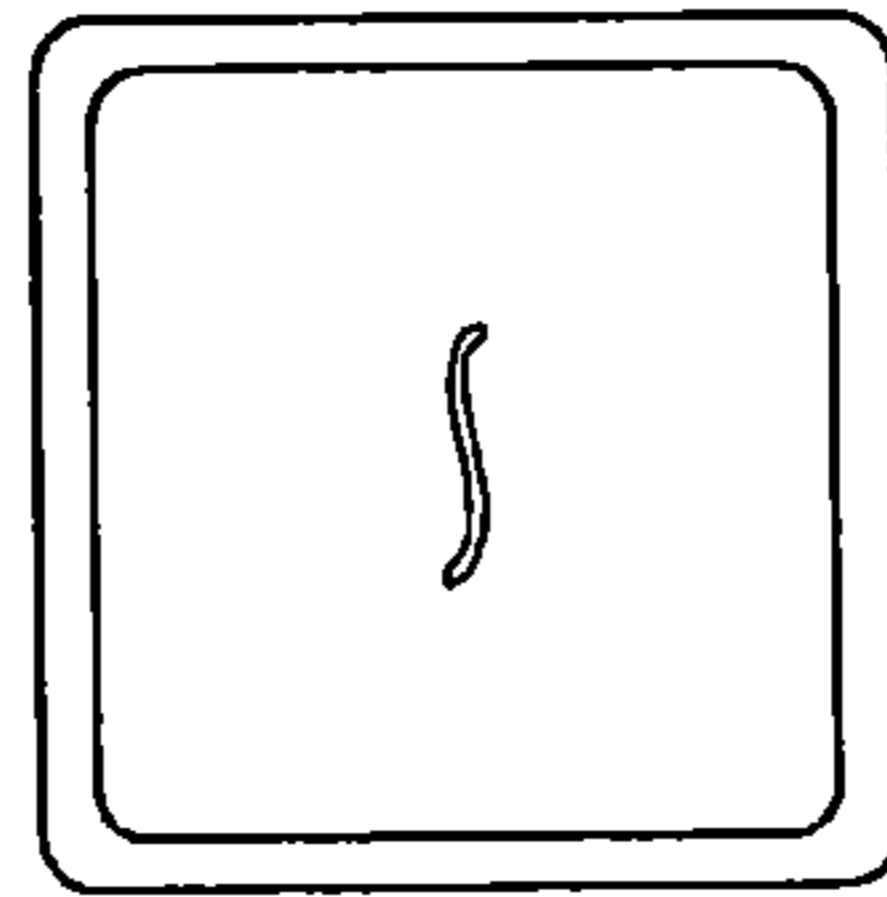

Fig. 342

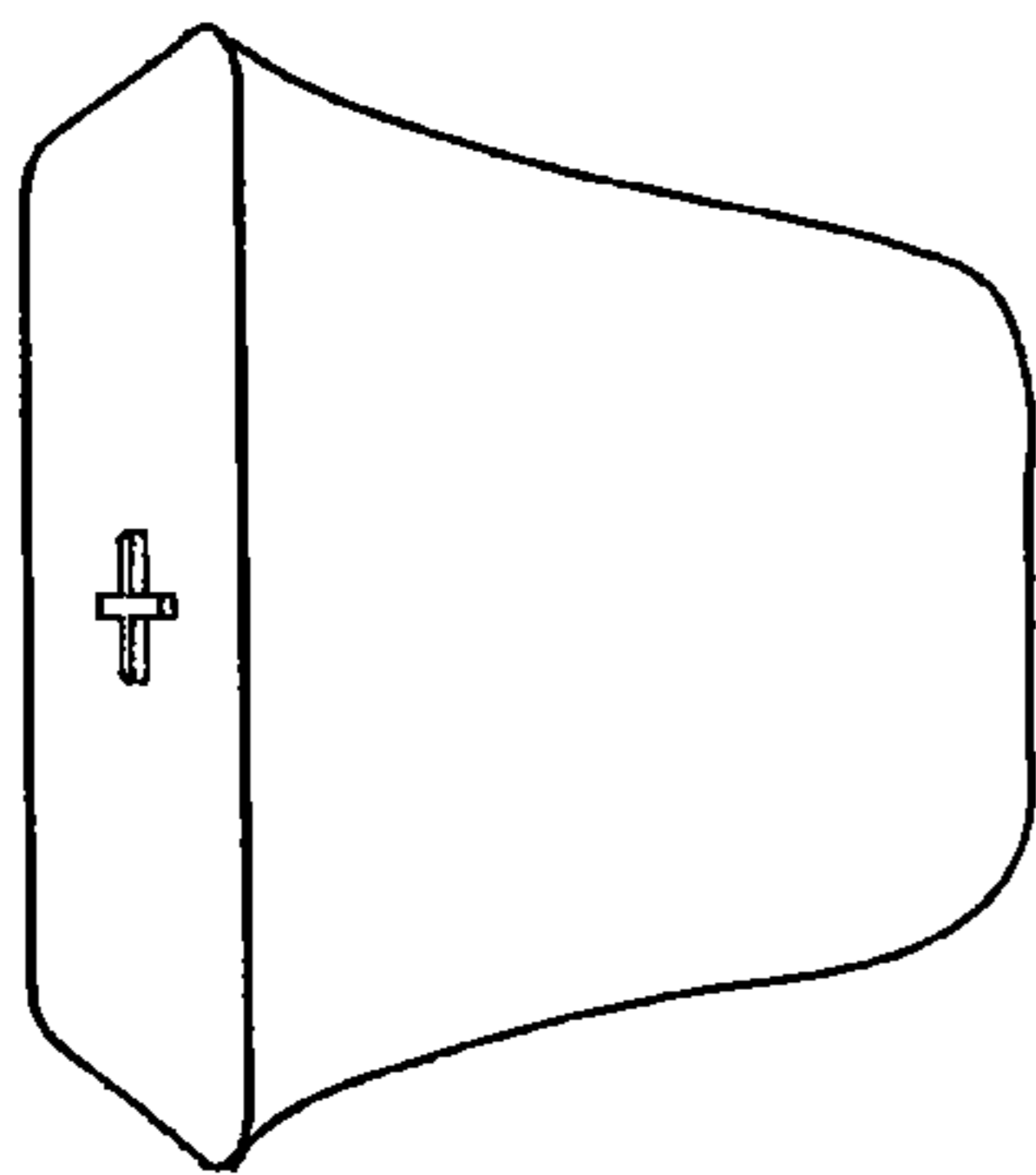

Fig. 343

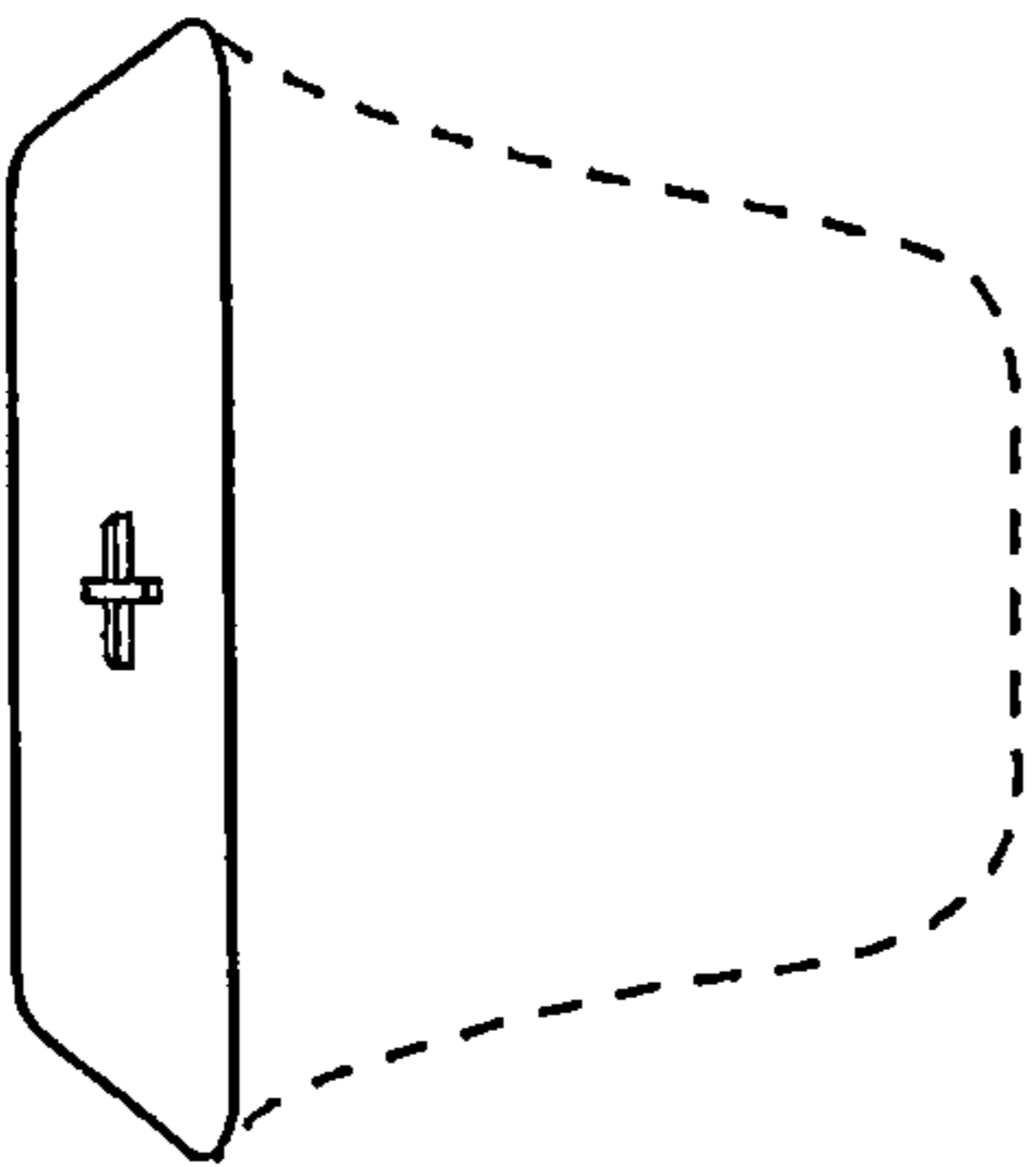

Fig. 344

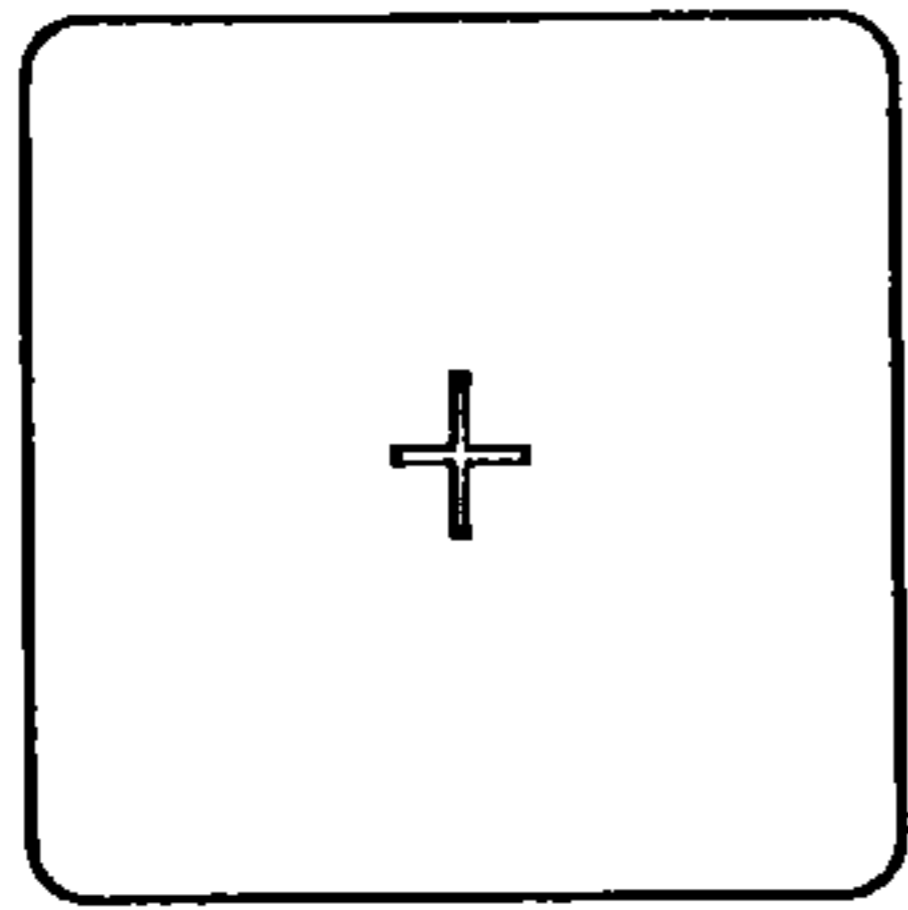

Fig. 345

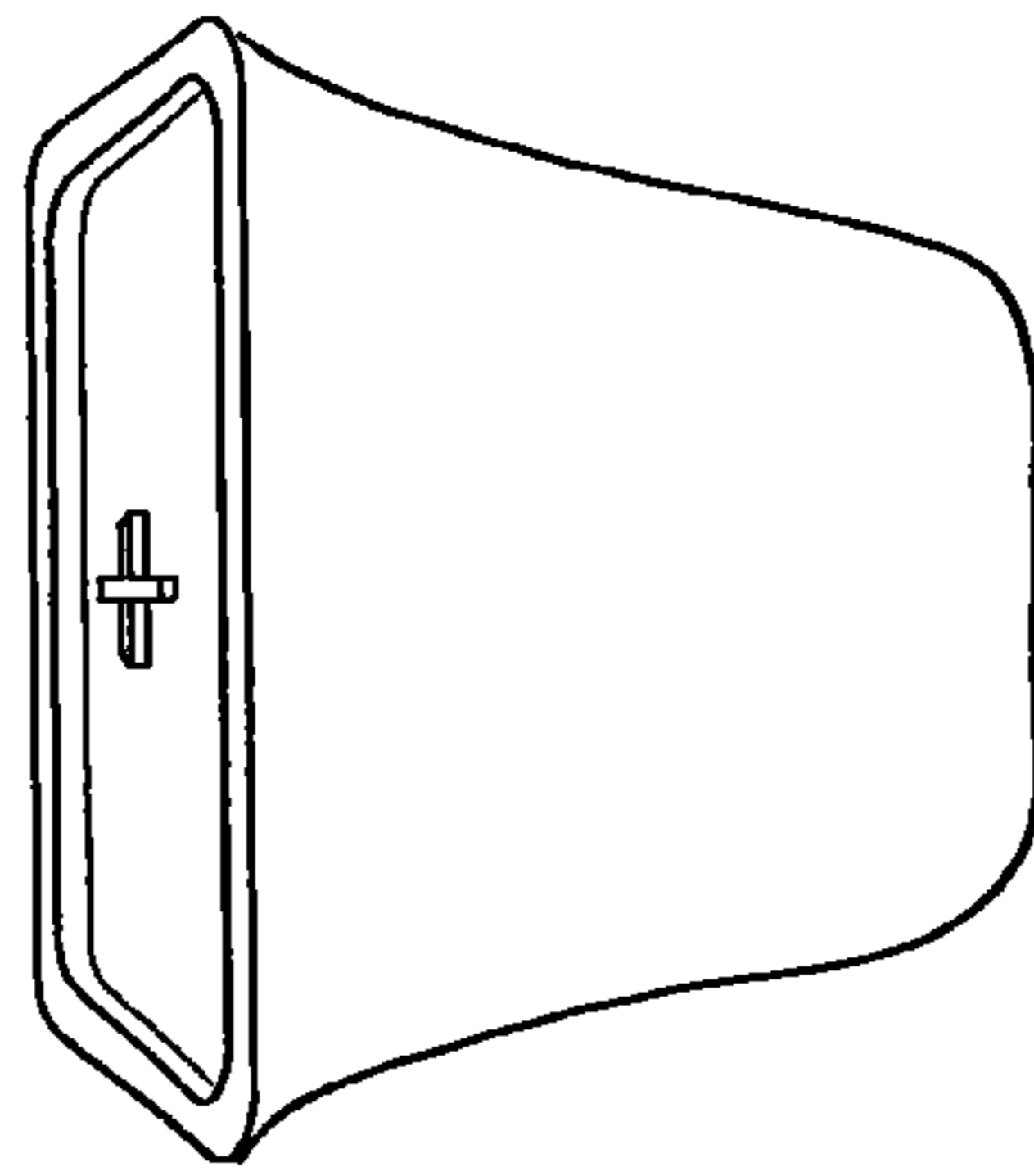

Fig. 346

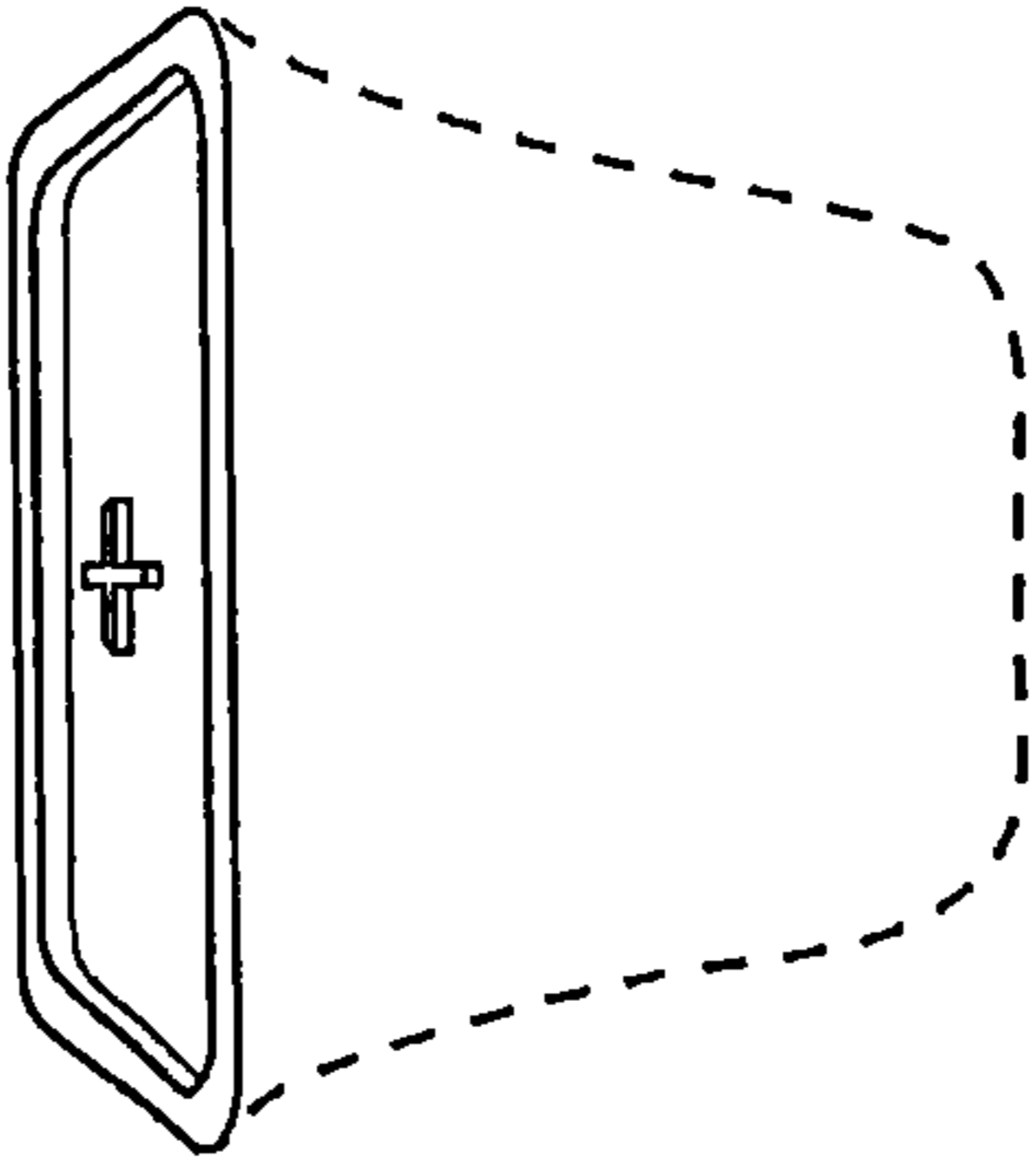

Fig. 347

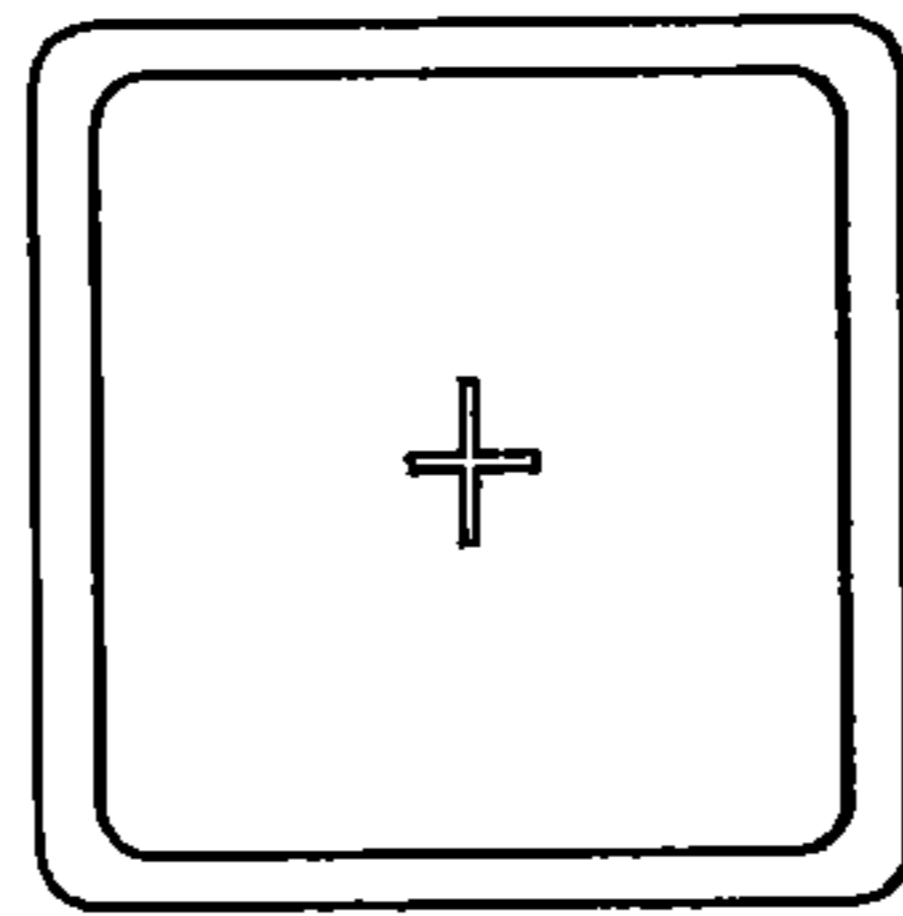

Fig. 348

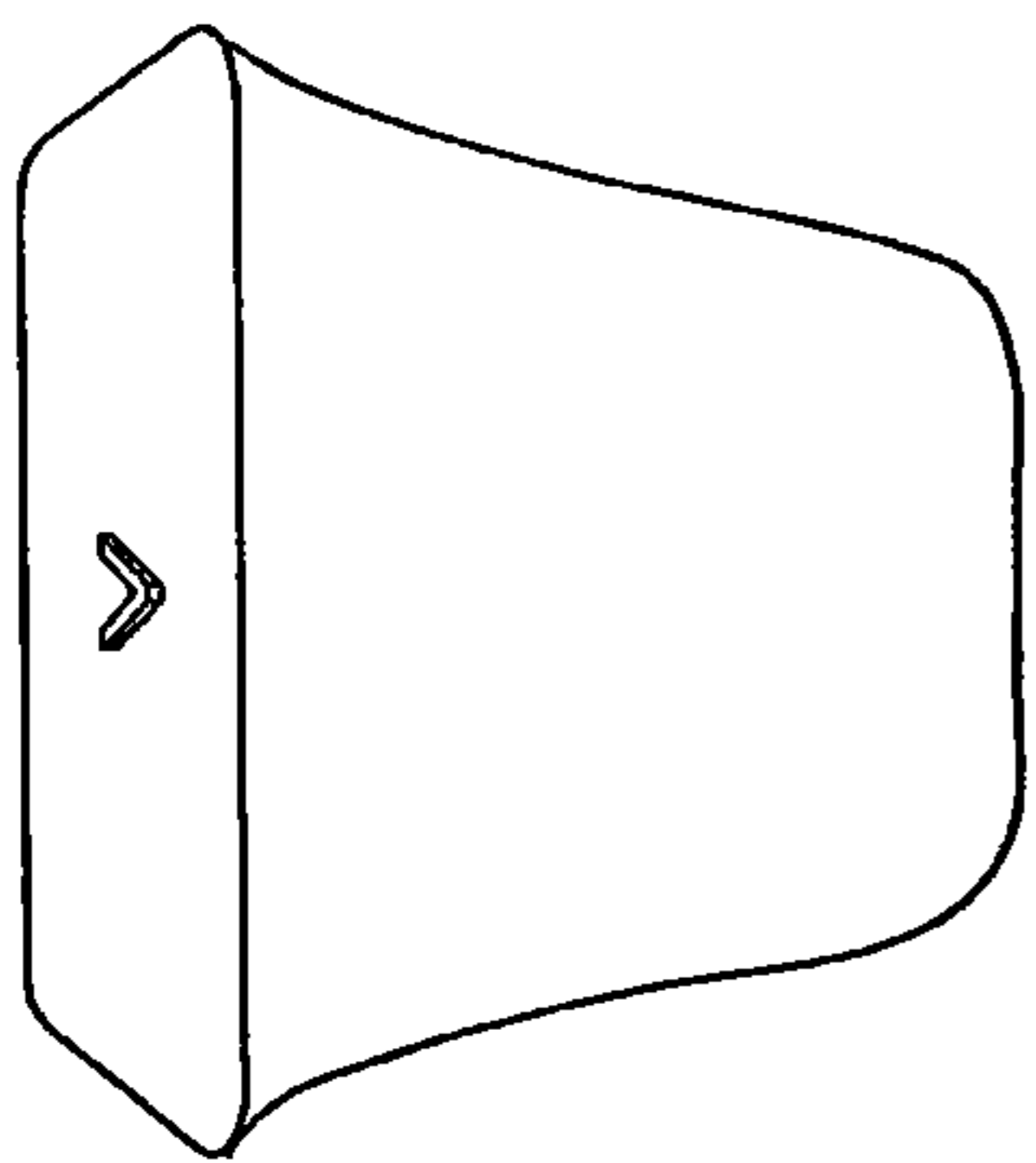

Fig. 349

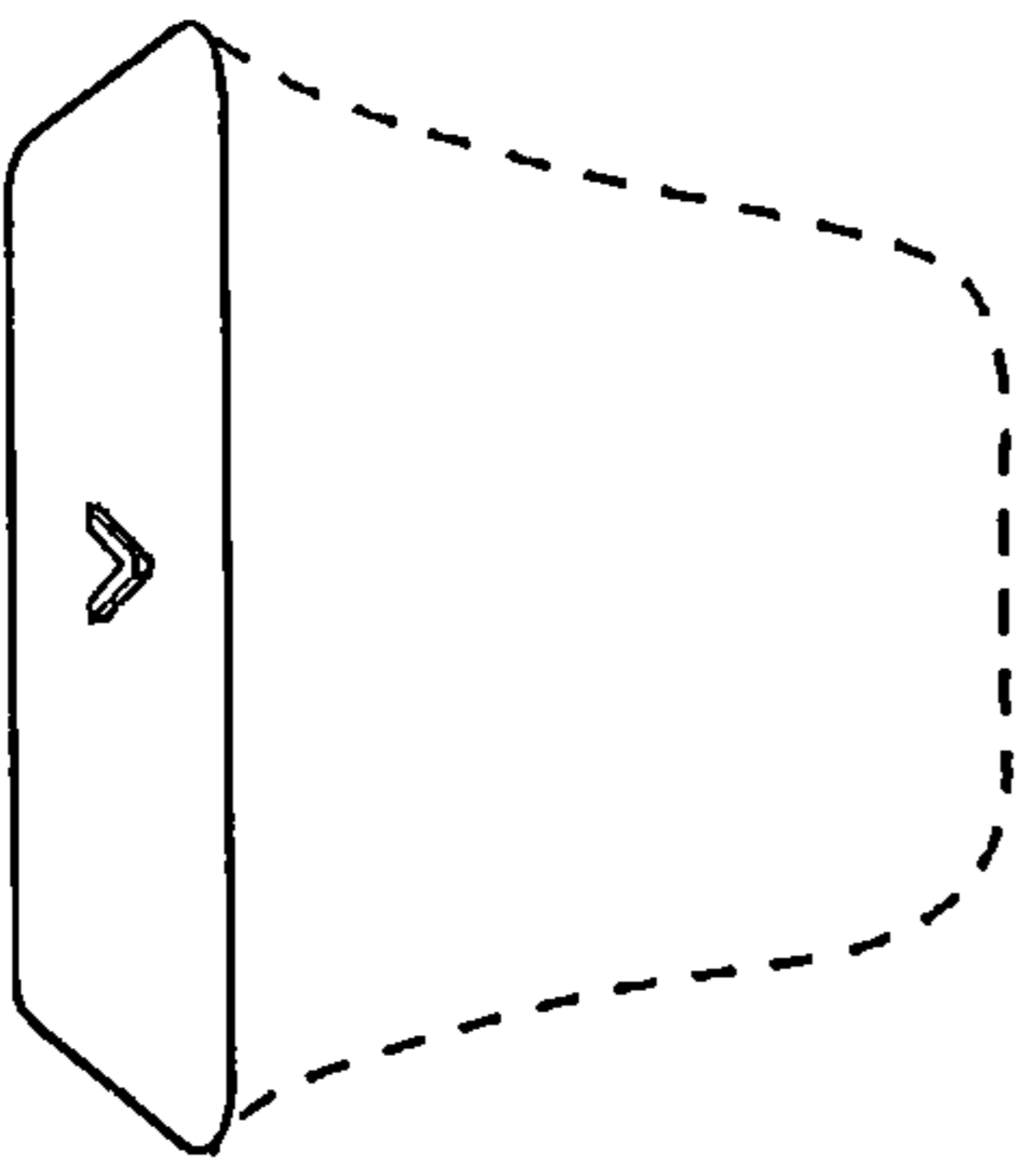

Fig. 350

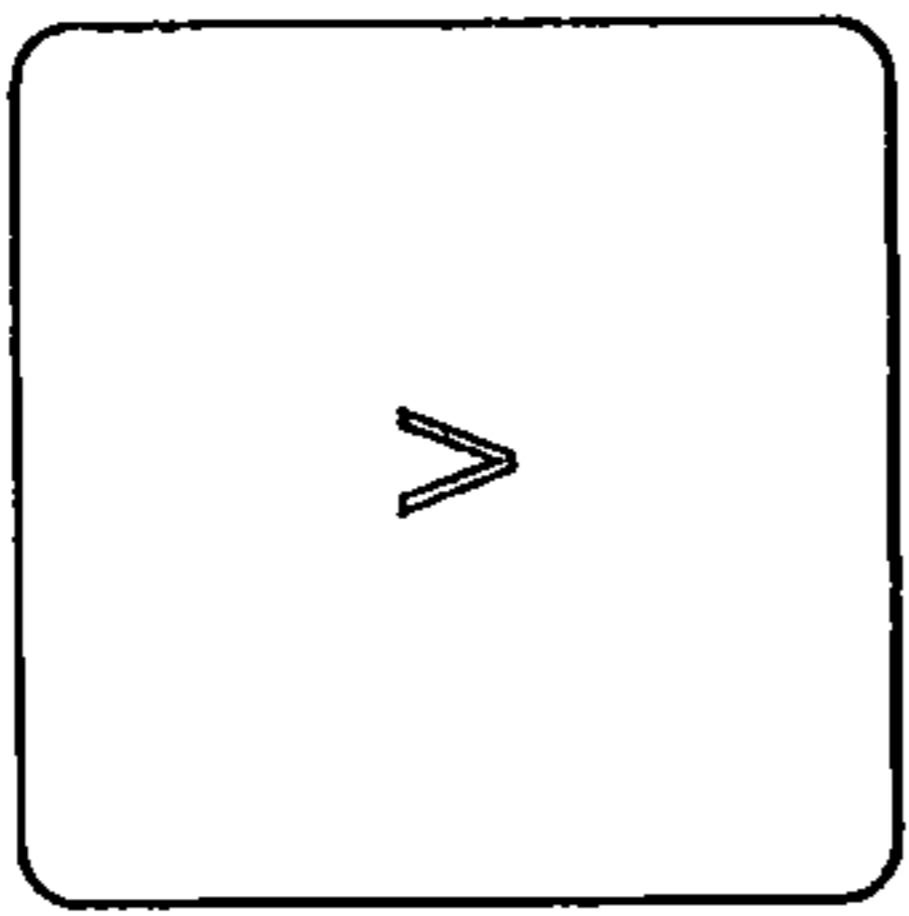

Fig. 351

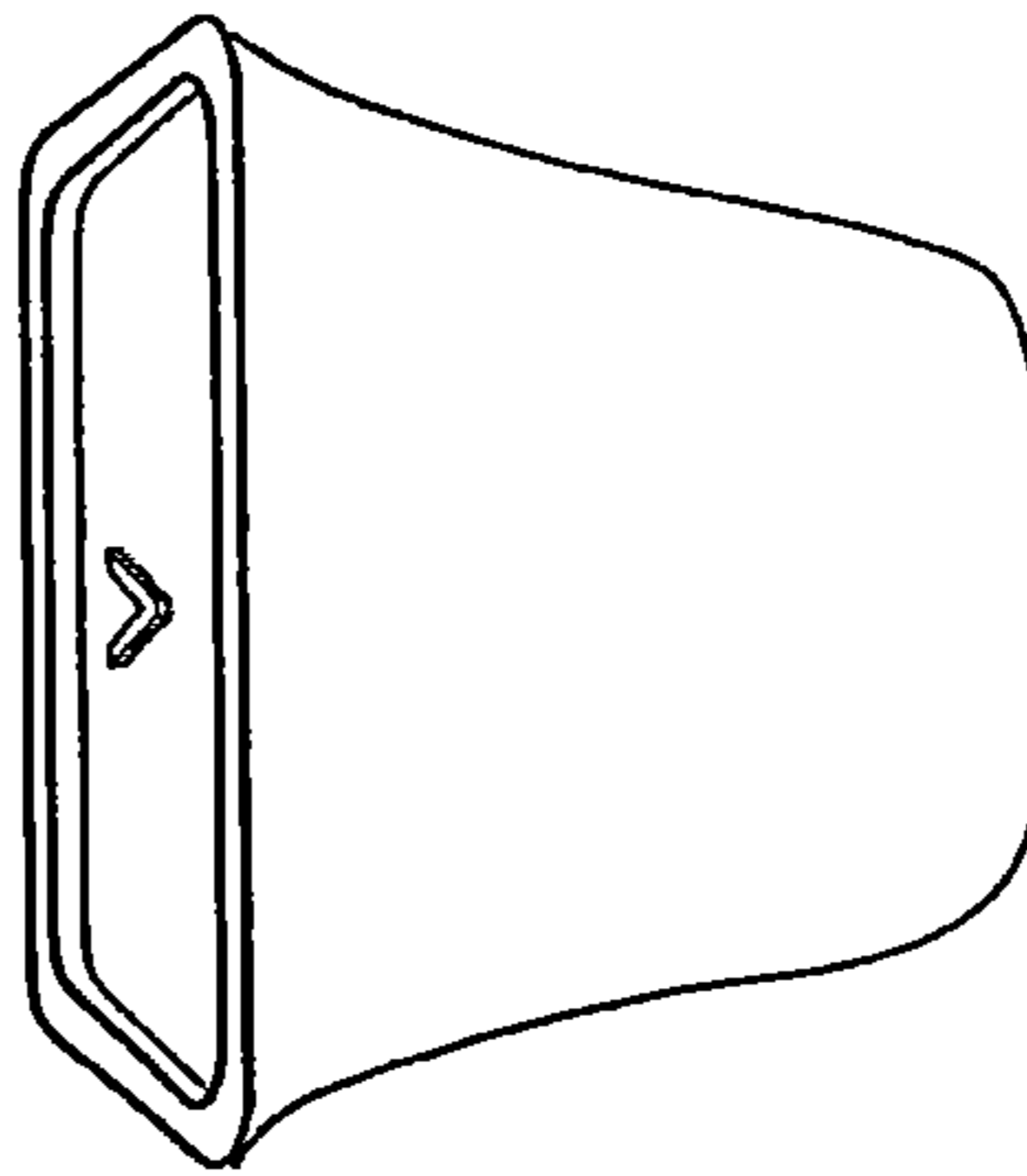

Fig. 352

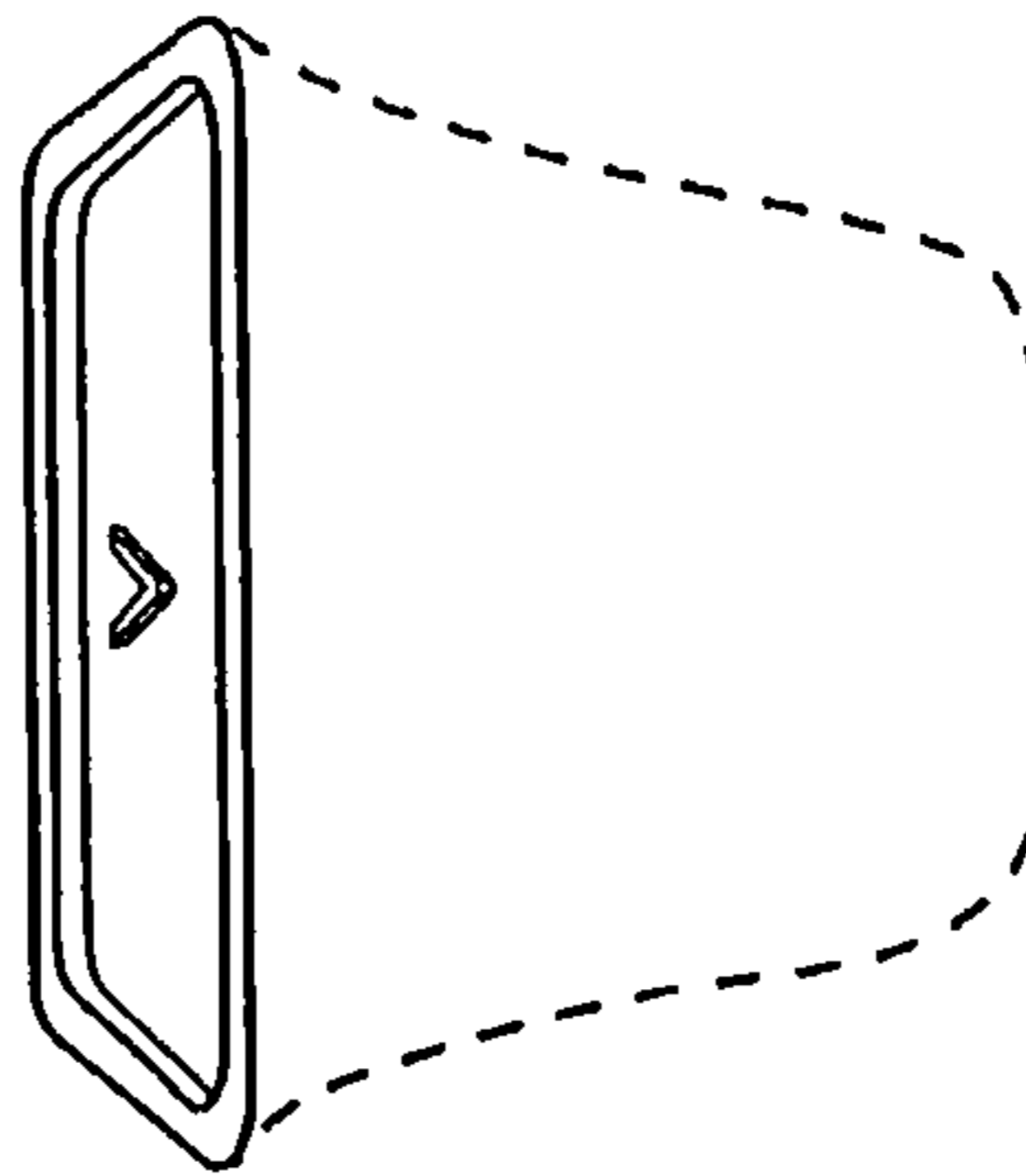

Fig. 353

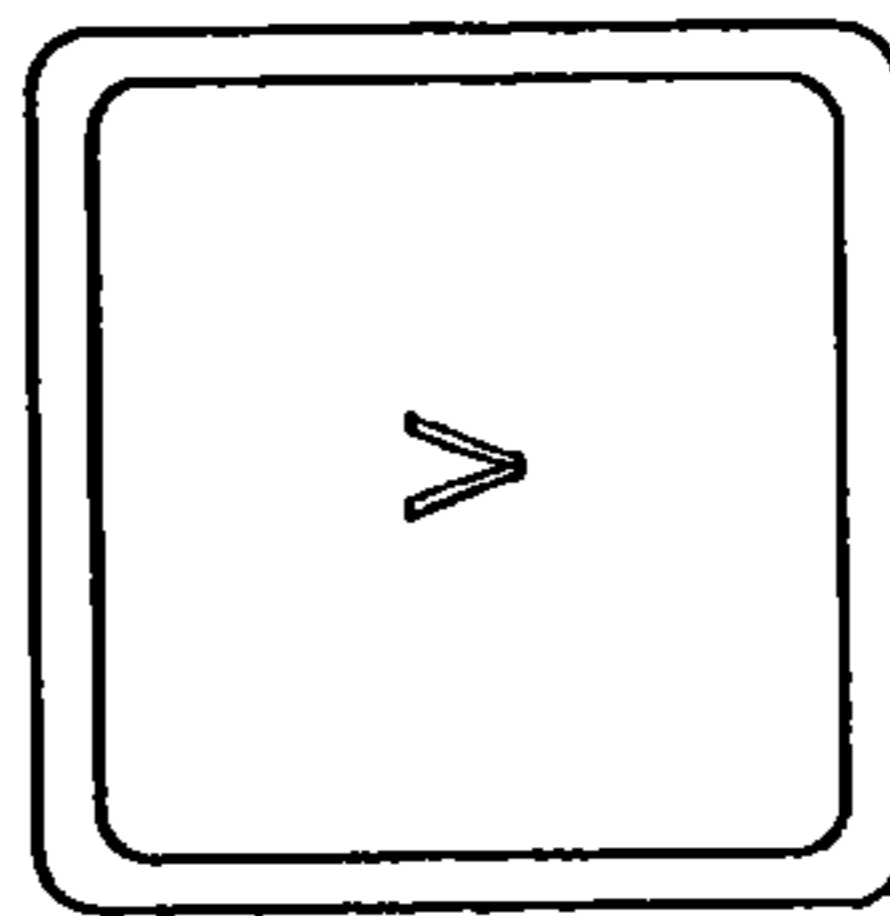

Fig. 354

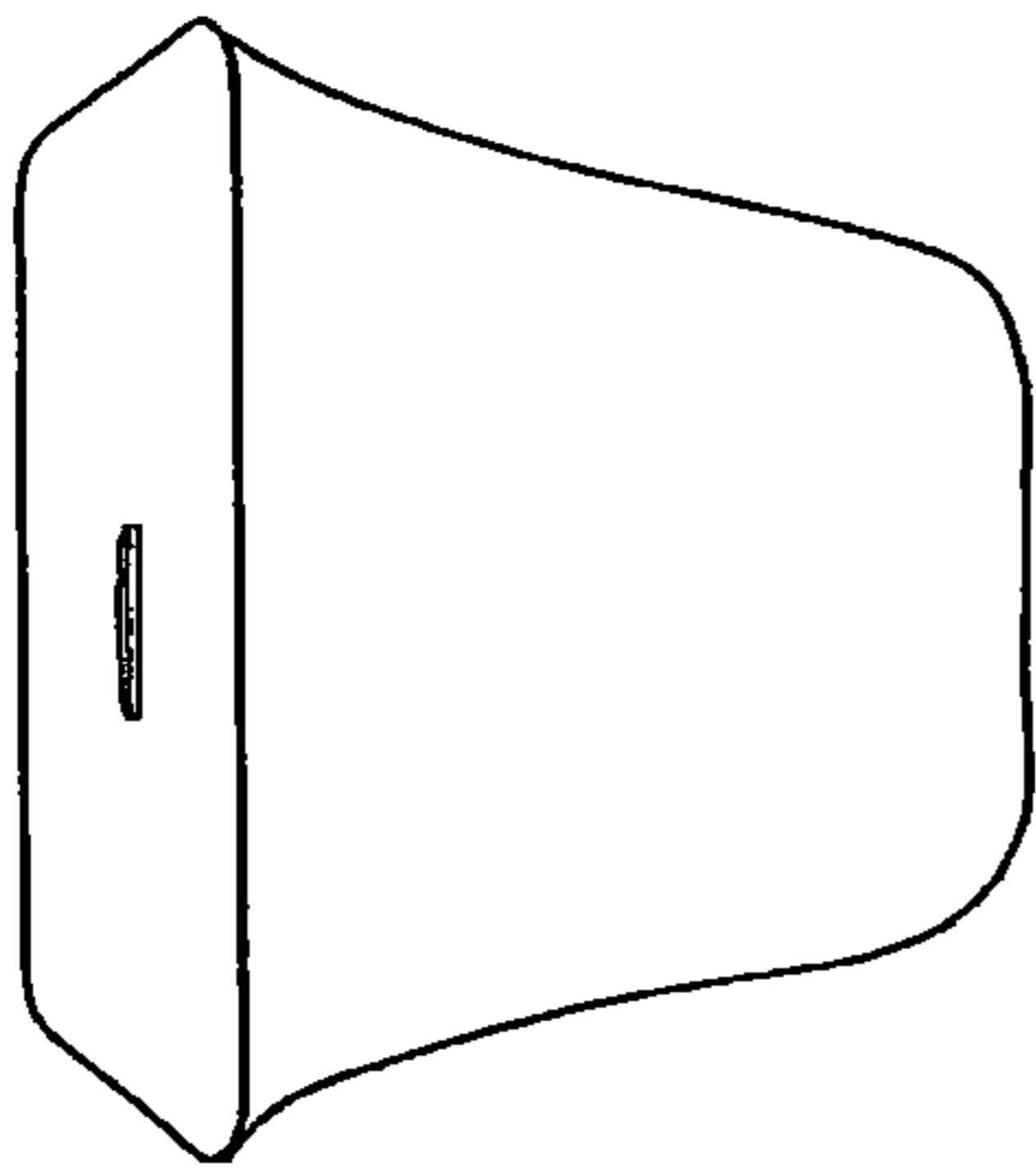

Fig. 355

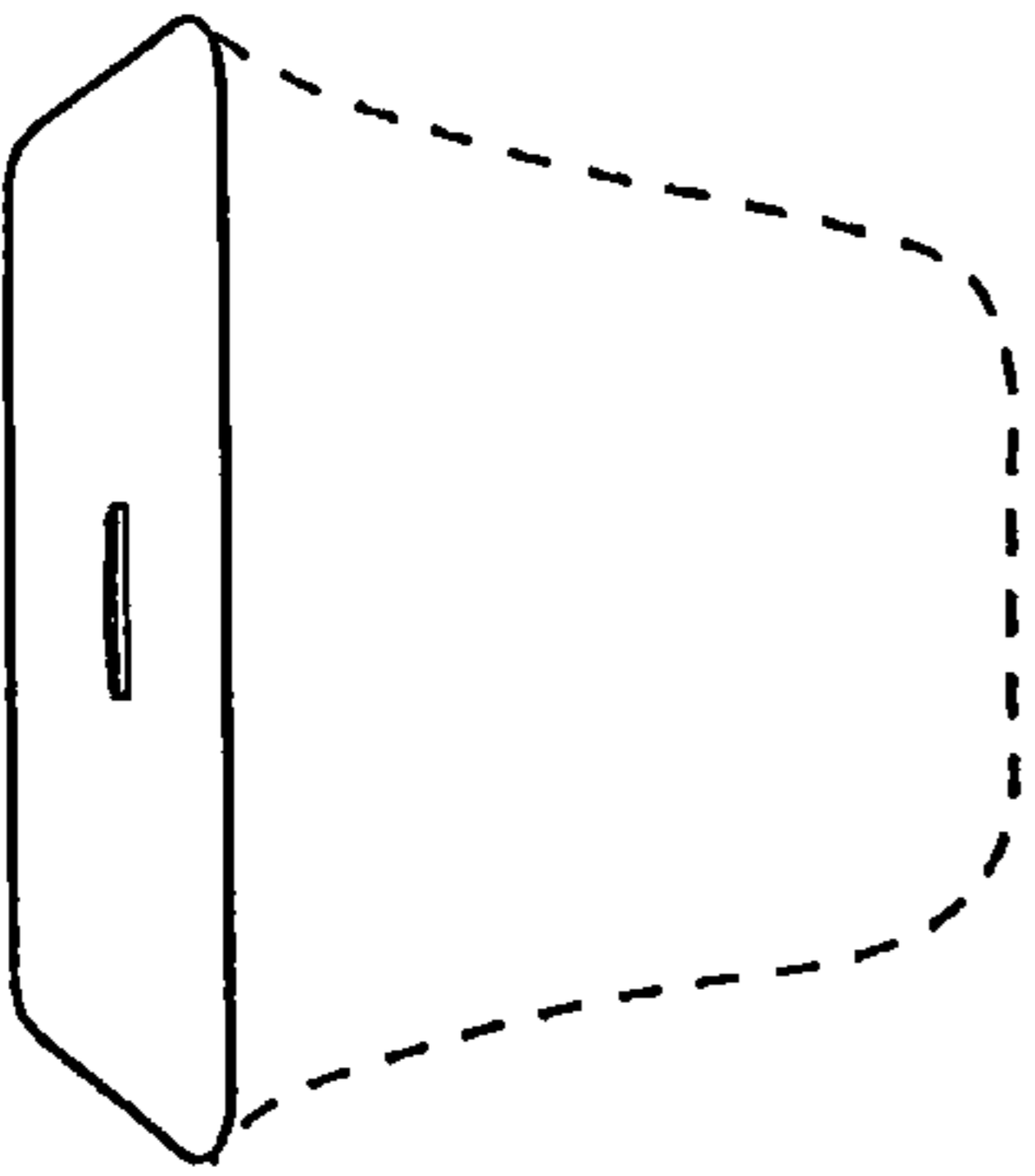

Fig. 356

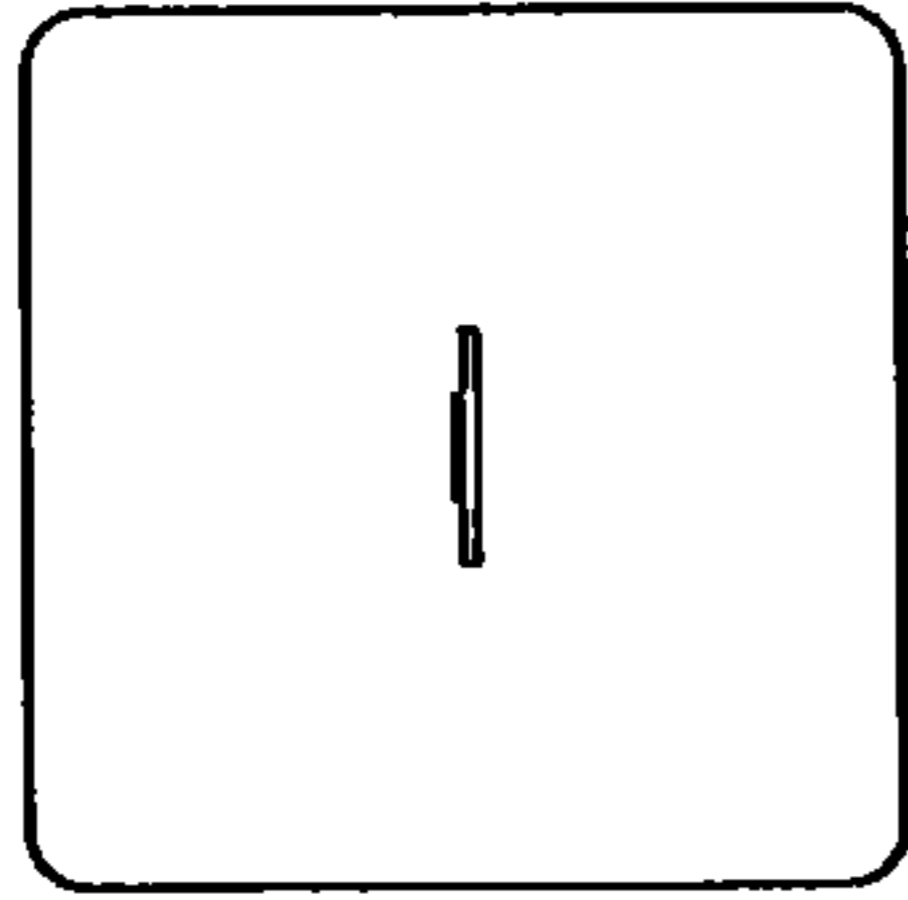

Fig. 357

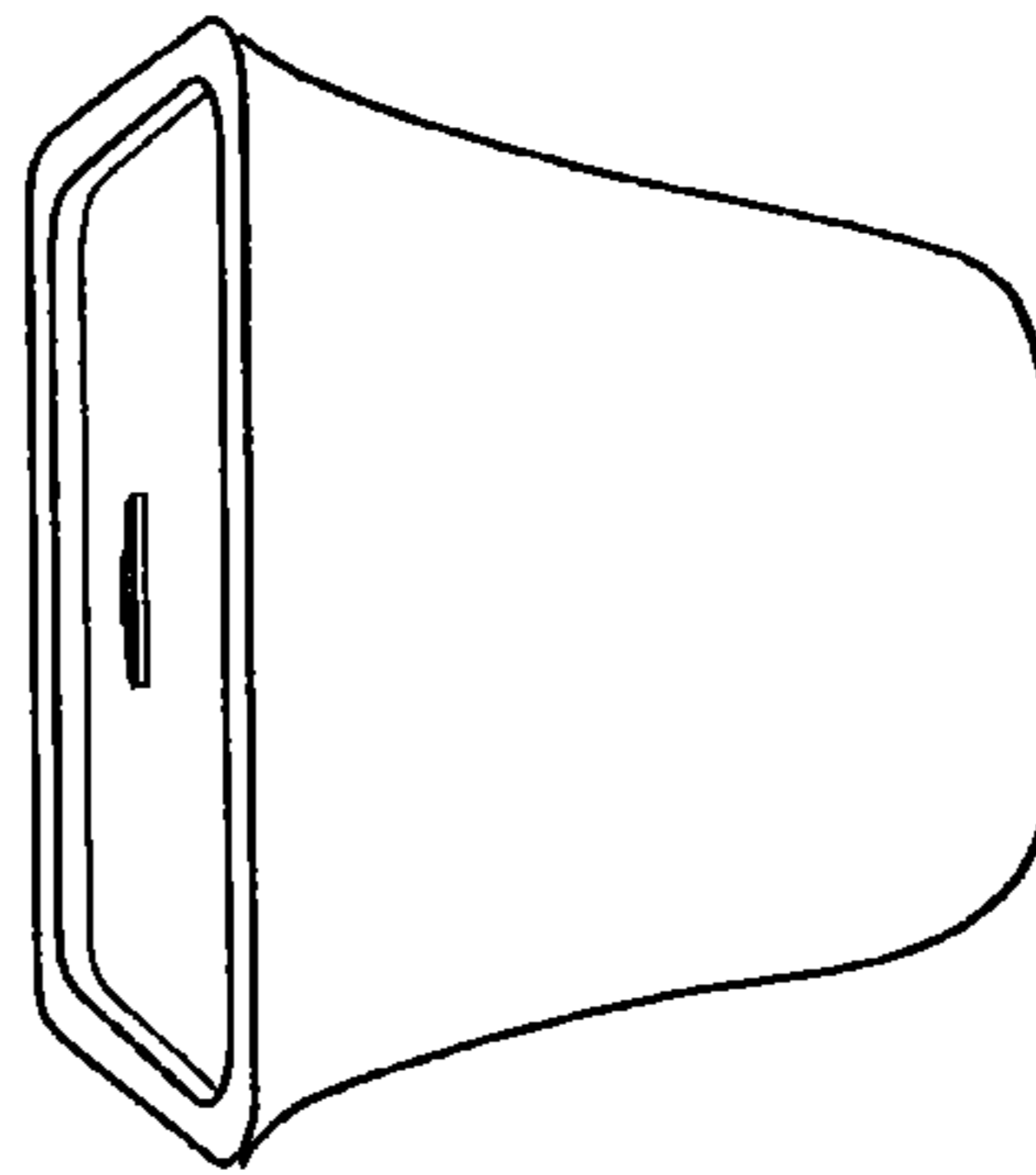

Fig. 358

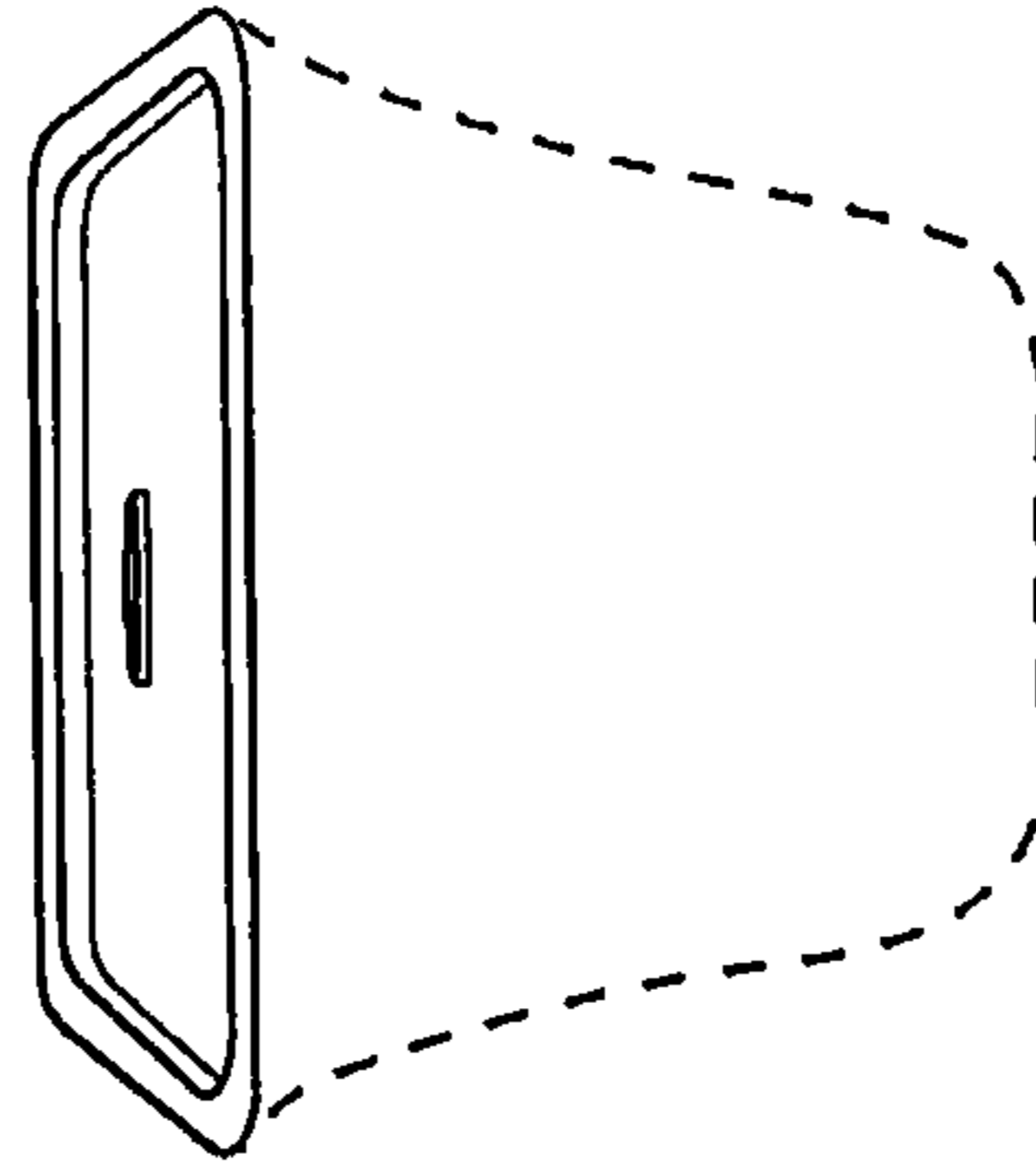

Fig. 359

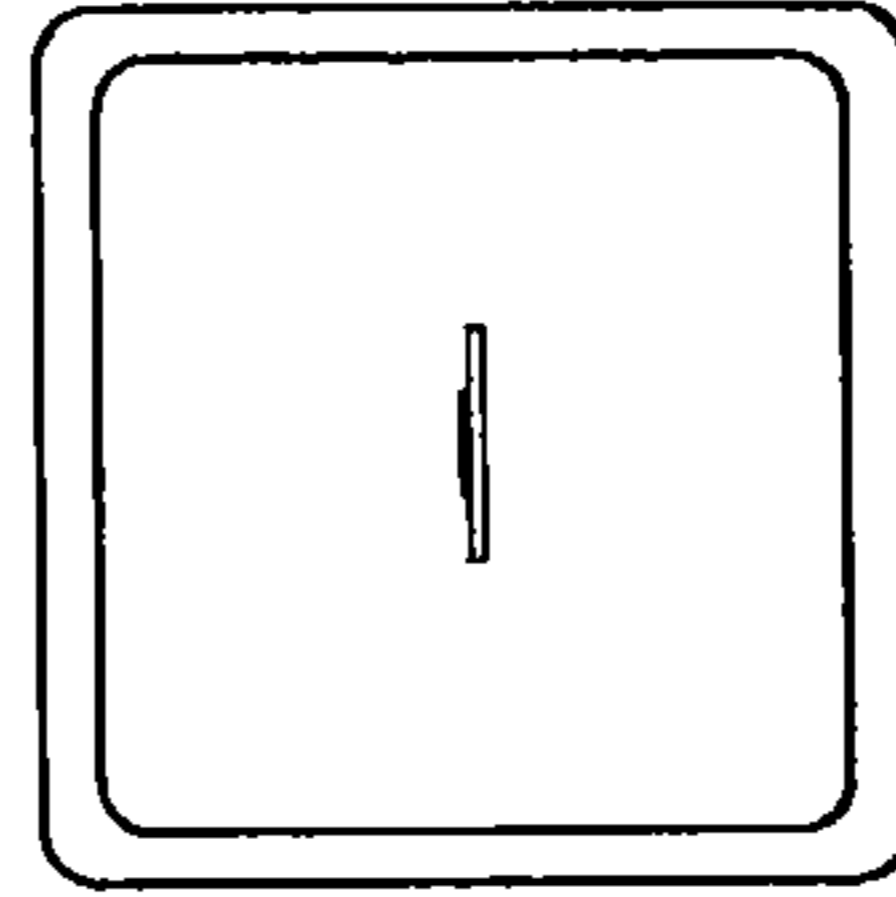

Fig. 360

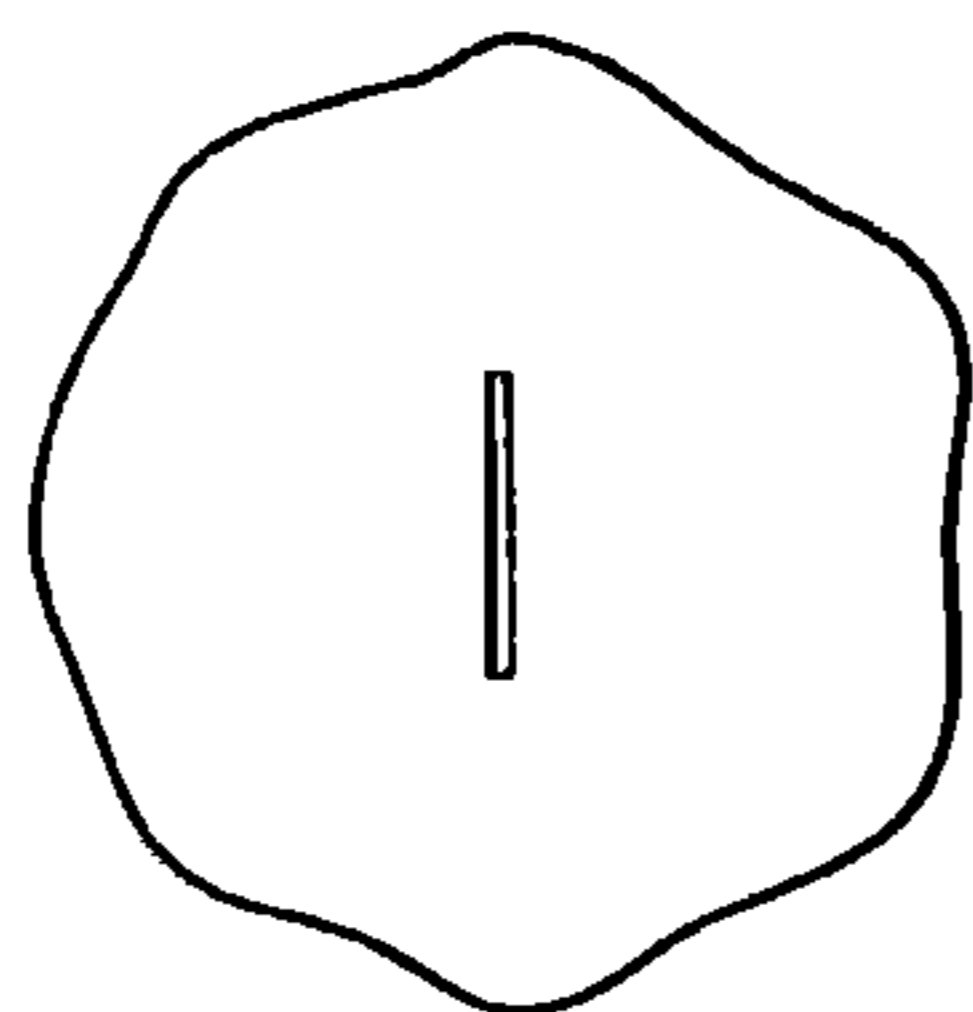

Fig. 363

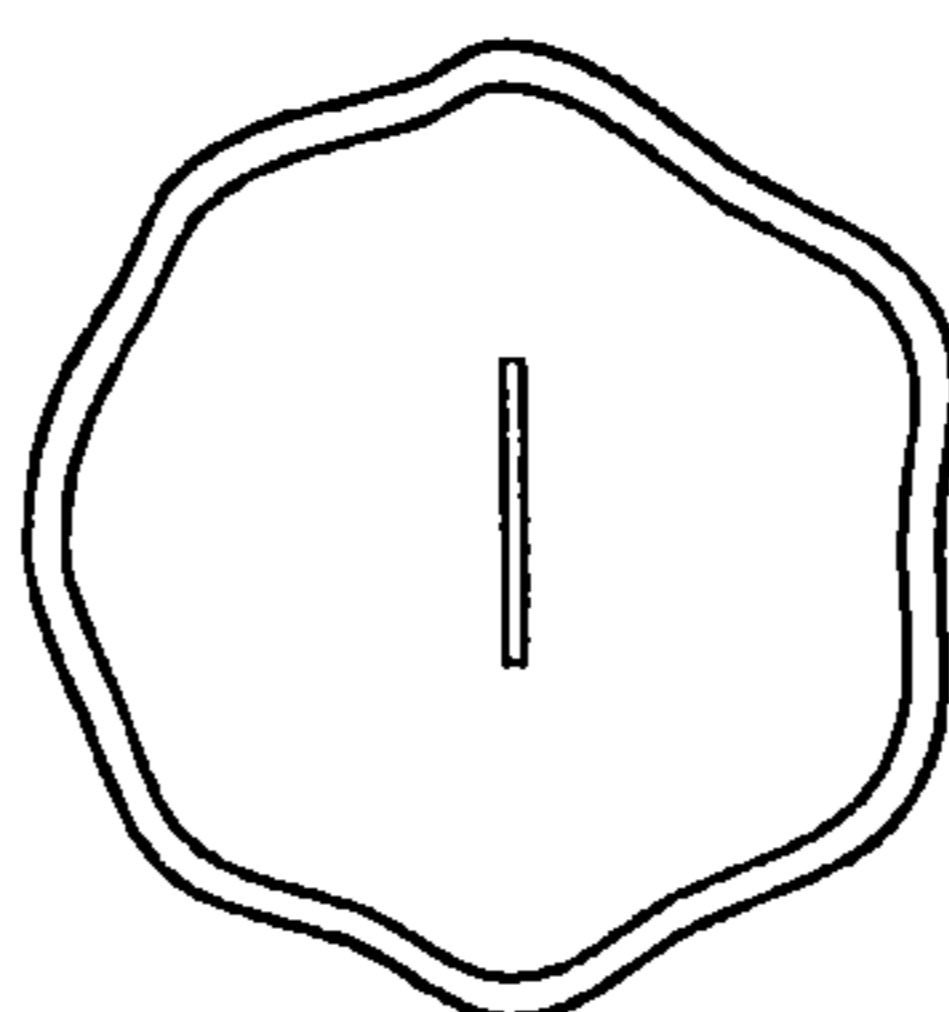

Fig. 366

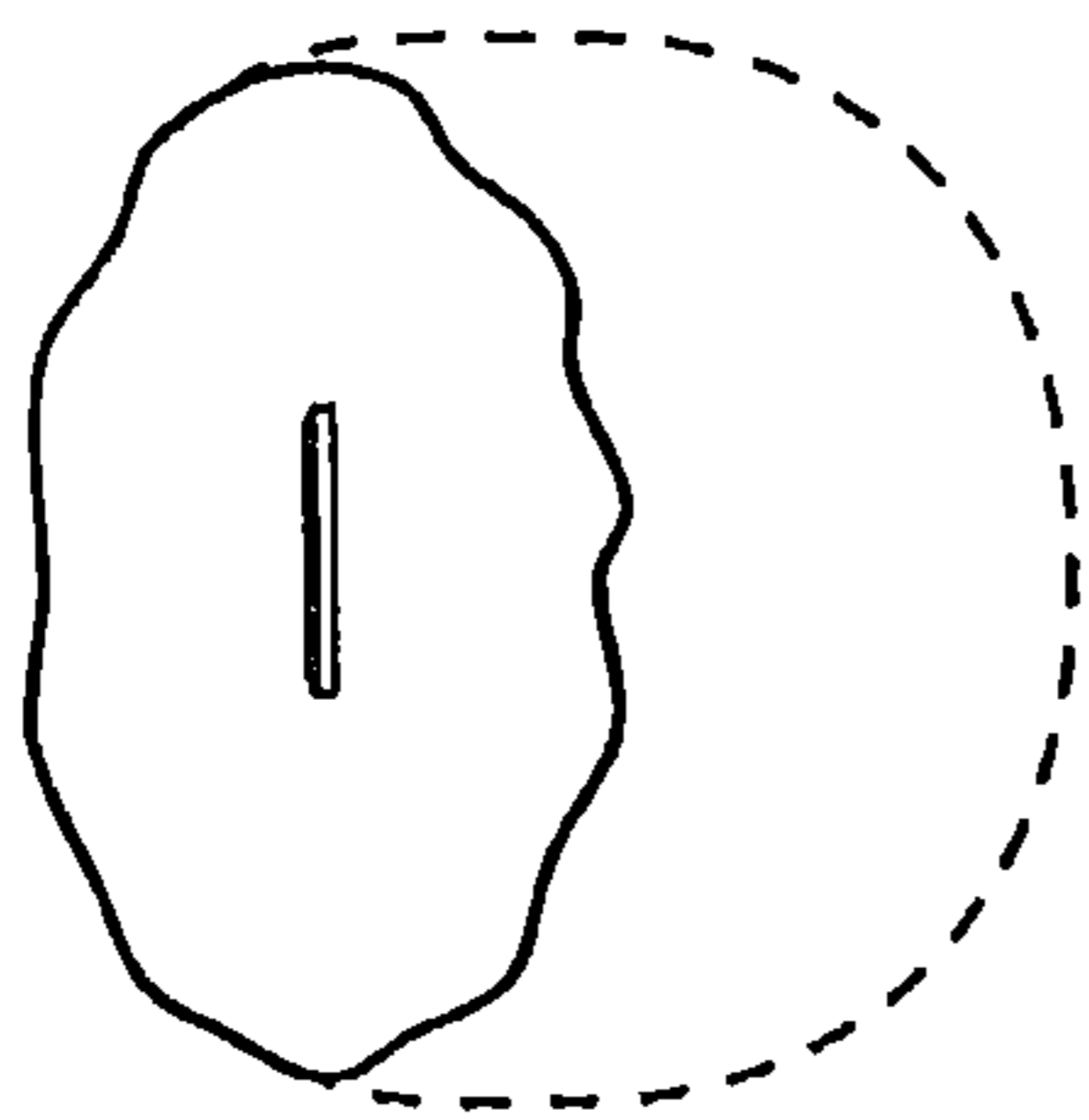

Fig. 362

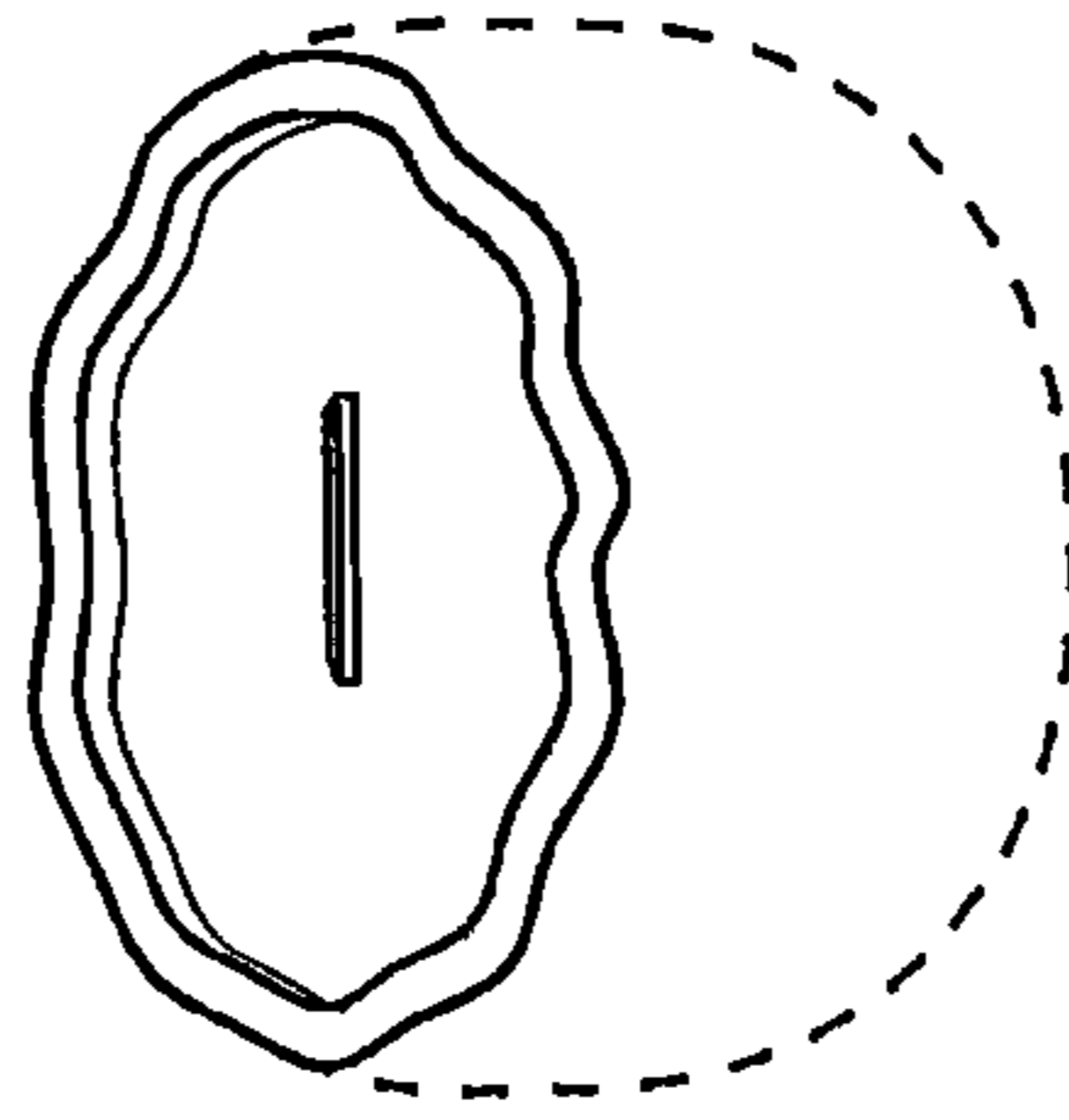

Fig. 365

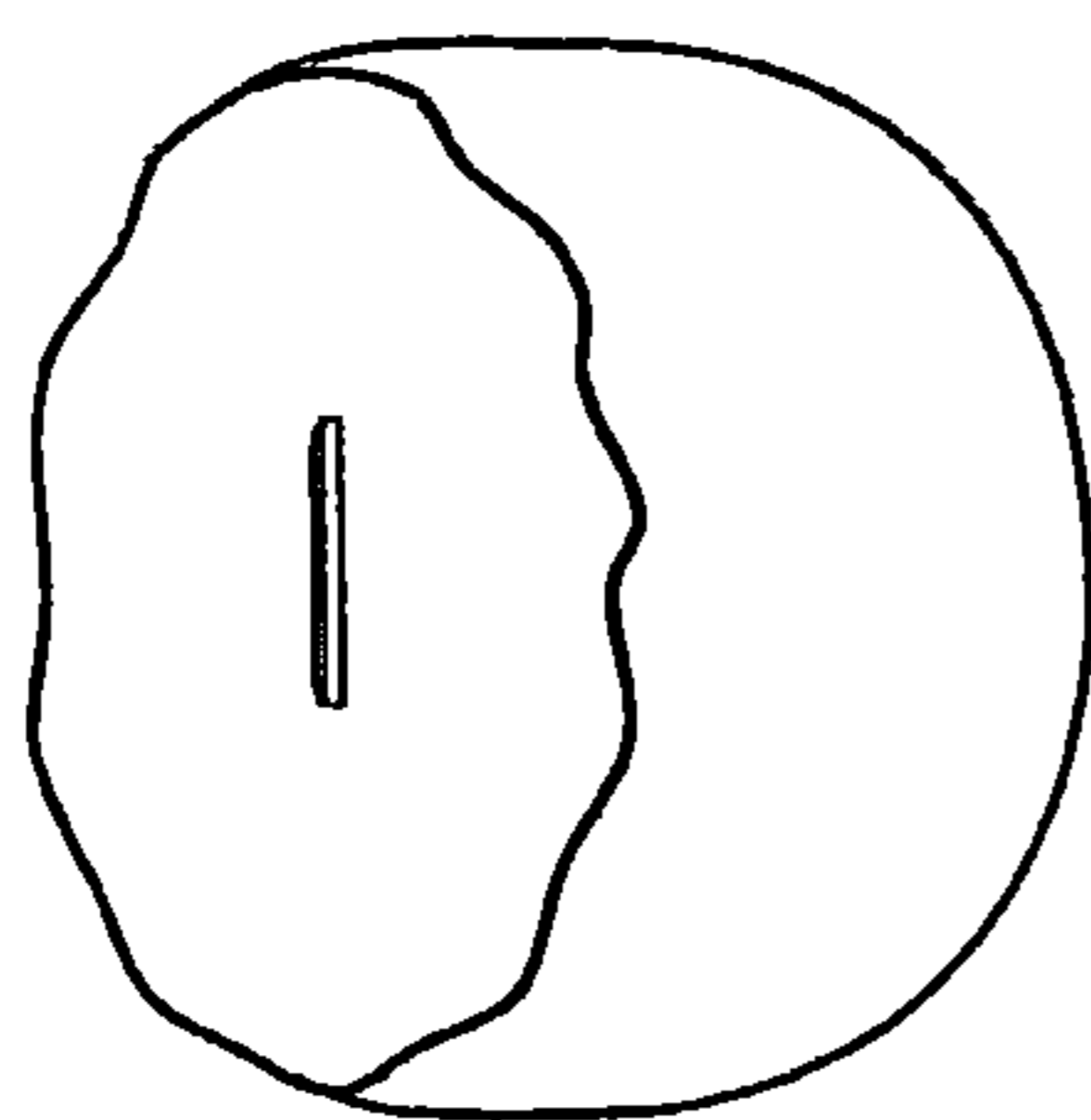

Fig. 361

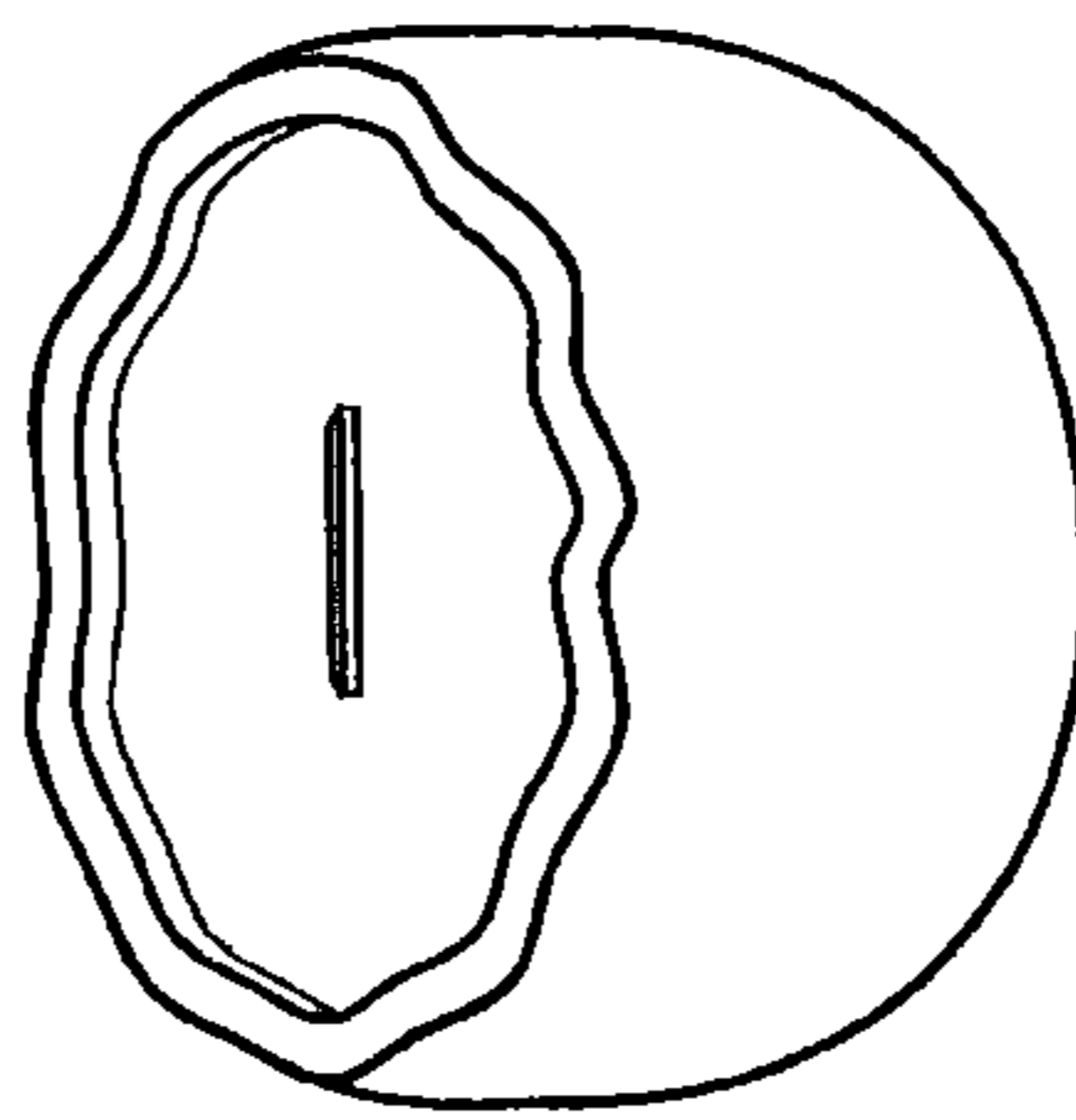

Fig. 364

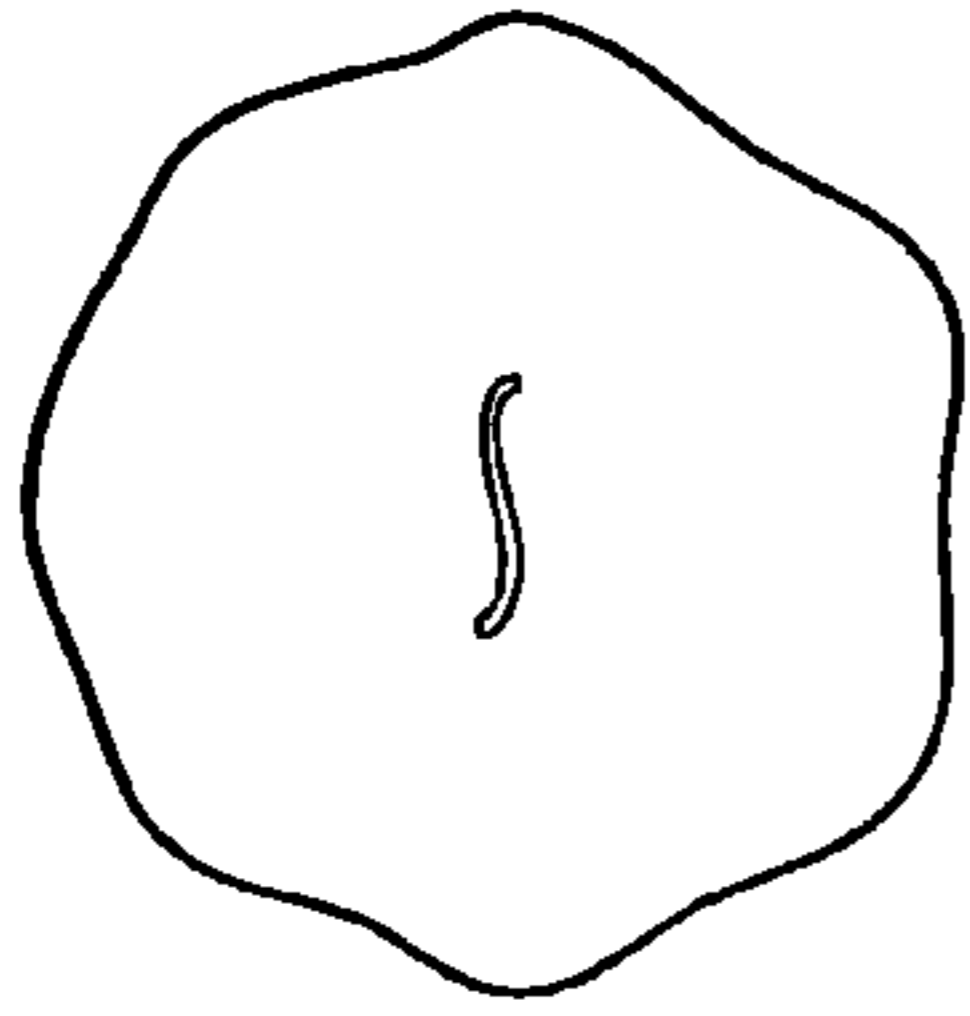

Fig. 369

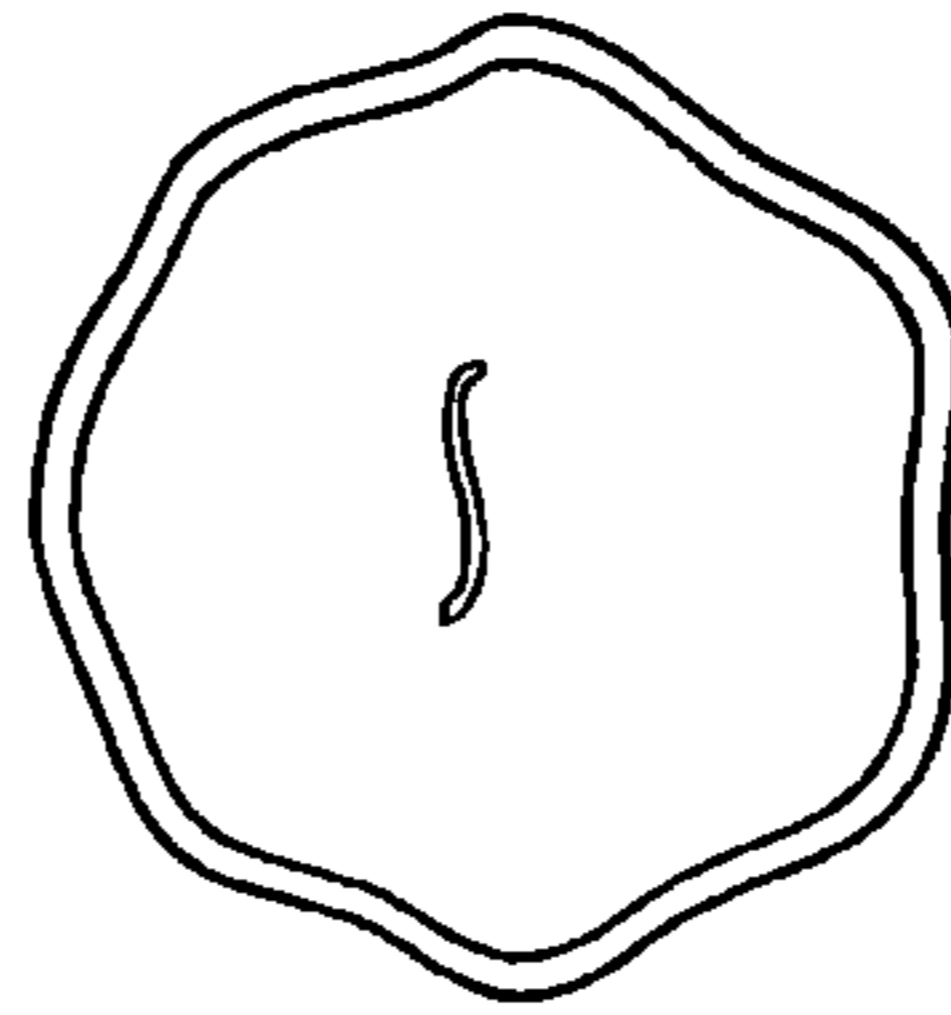

Fig. 372

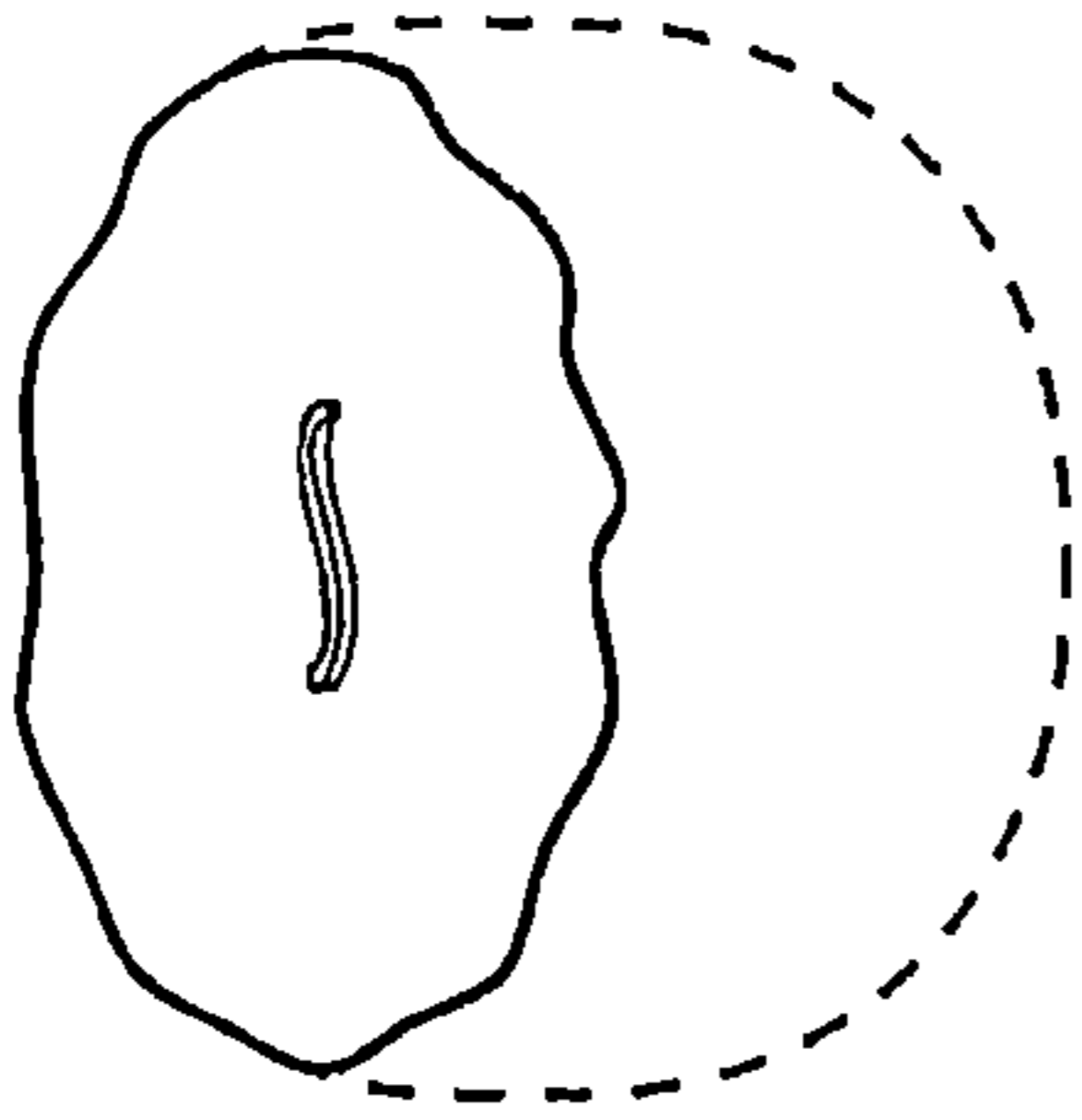

Fig. 368

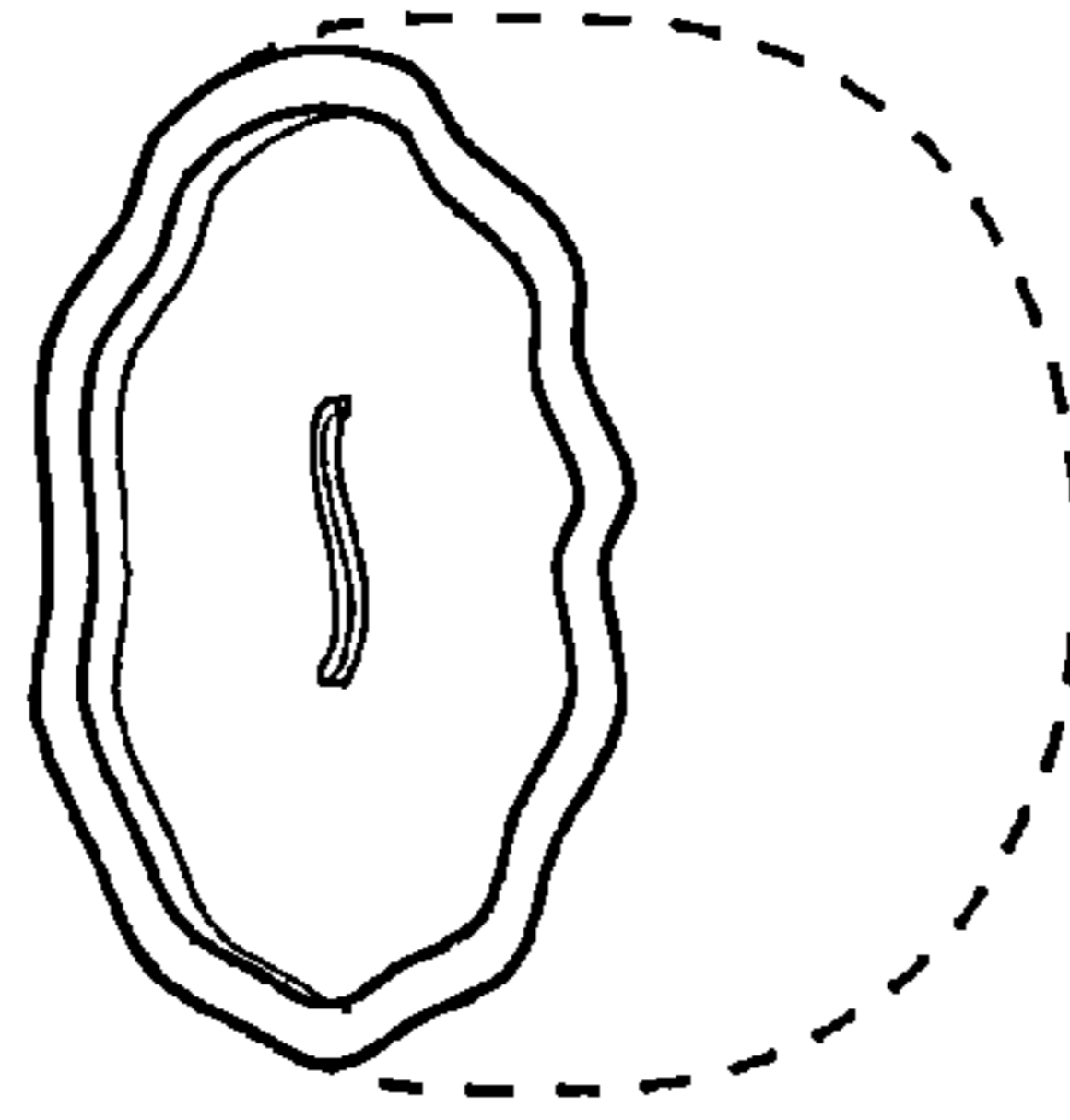

Fig. 371

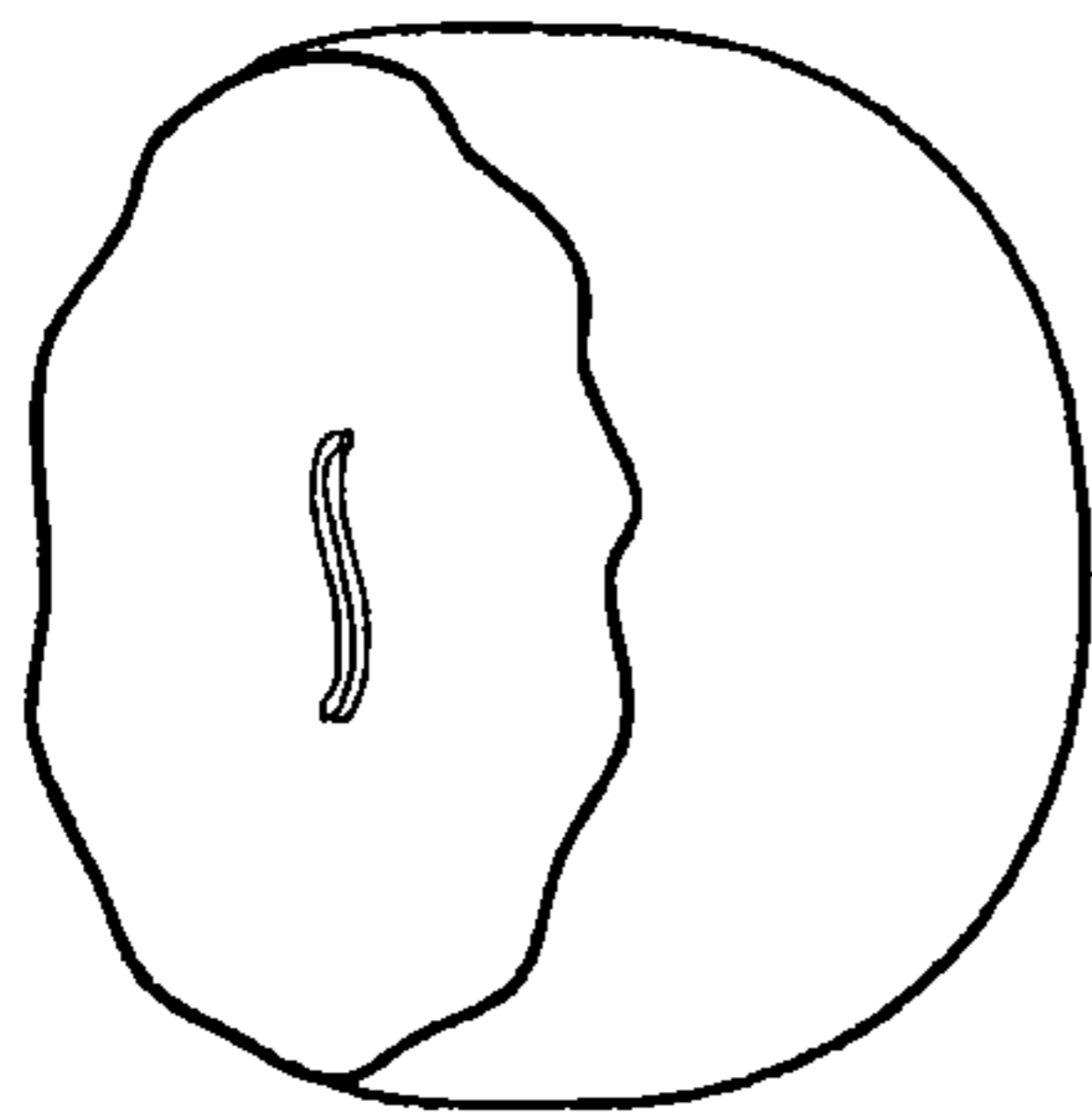

Fig. 367

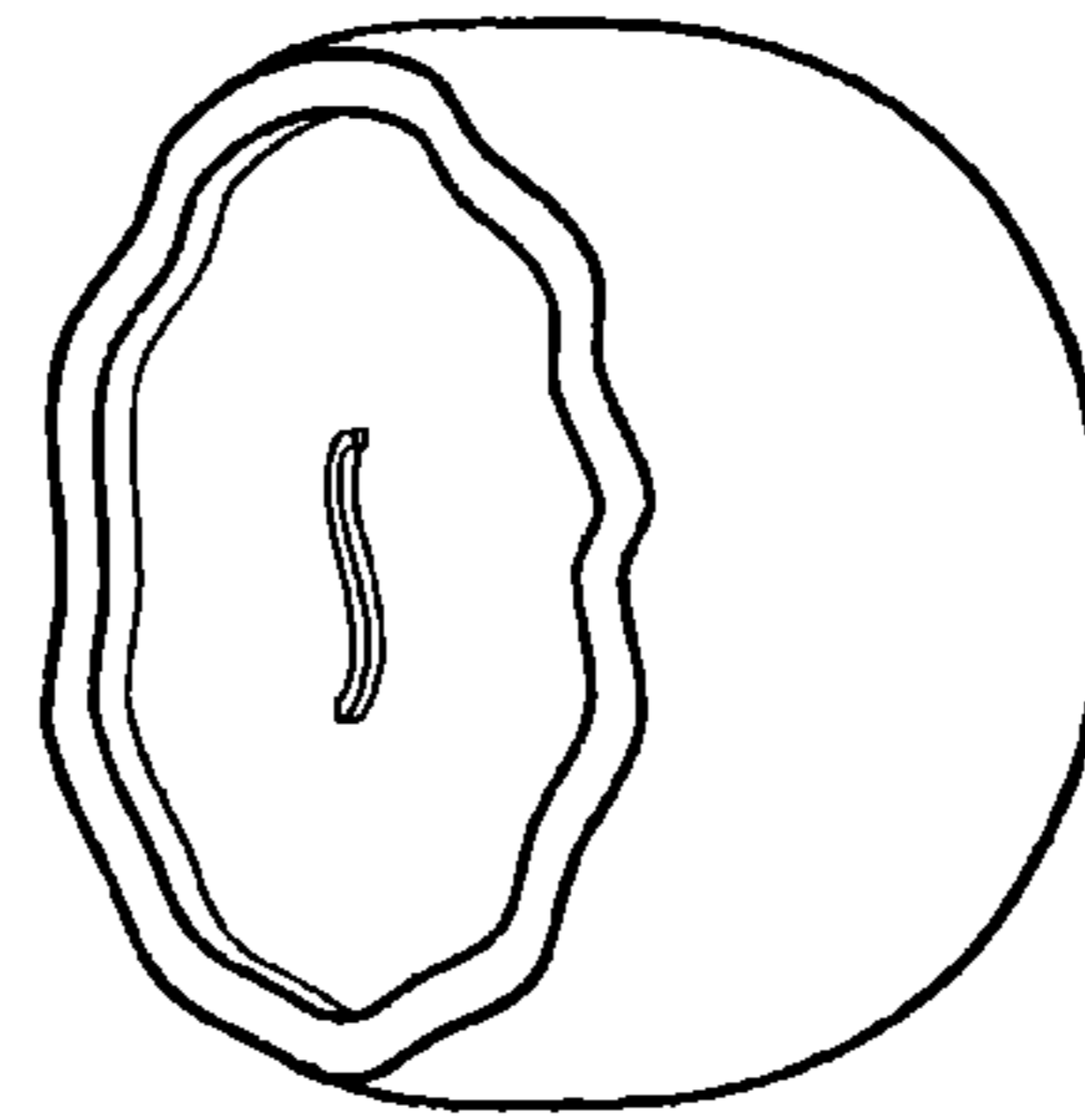

Fig. 370

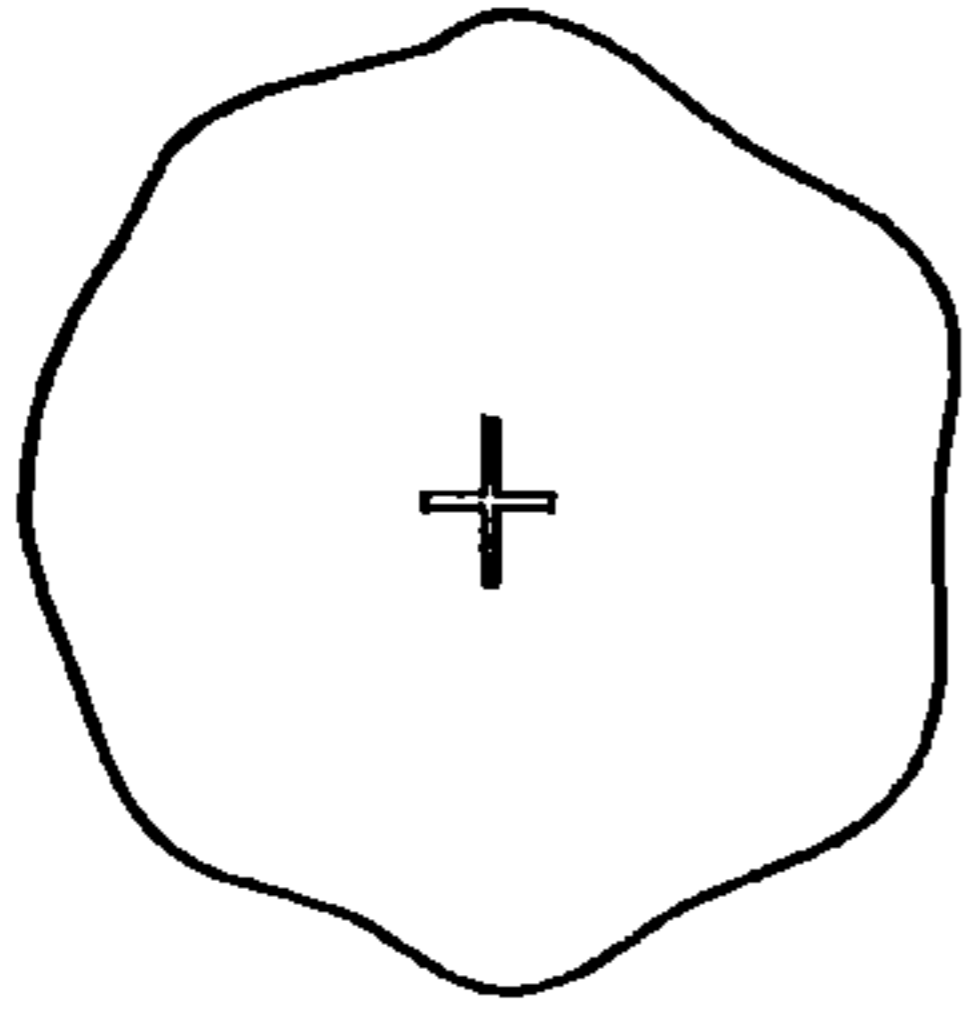

Fig. 375

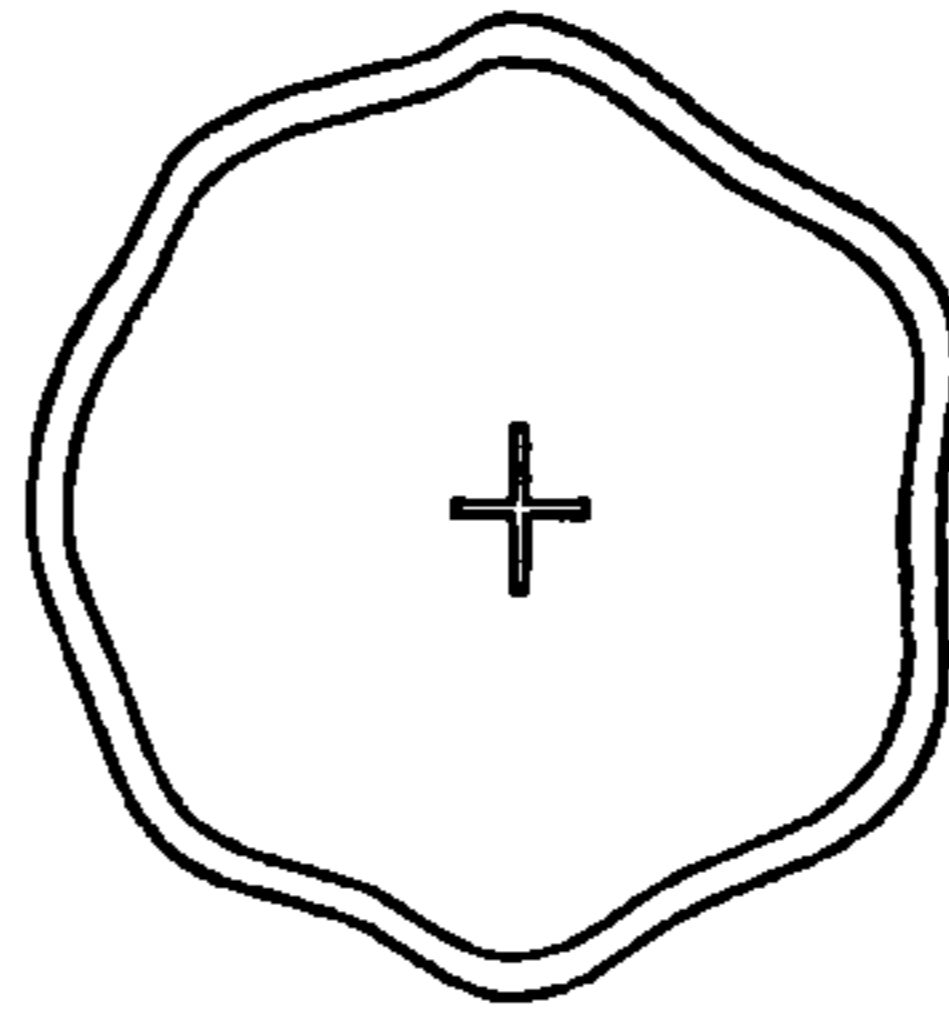

Fig. 378

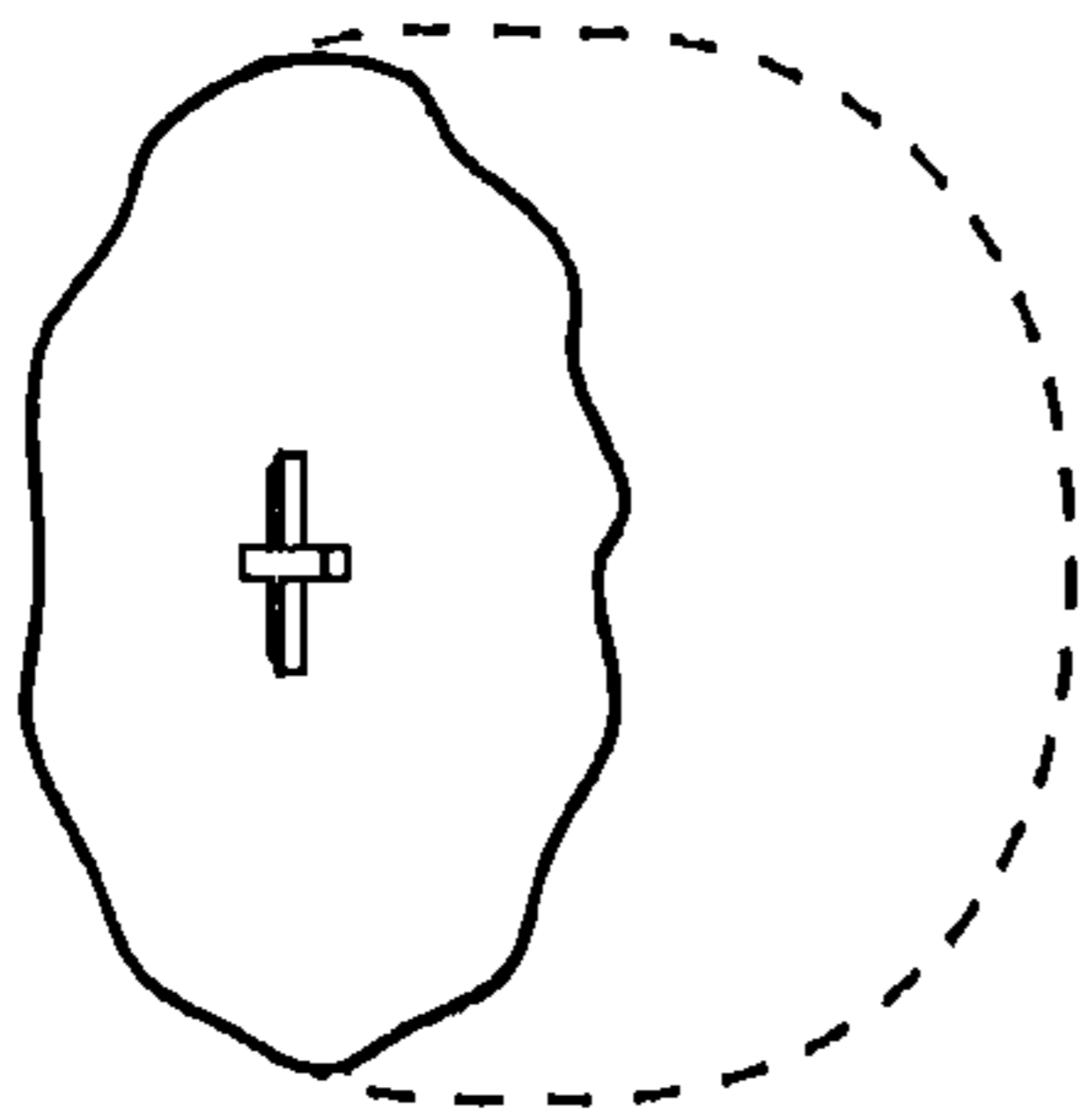

Fig. 374

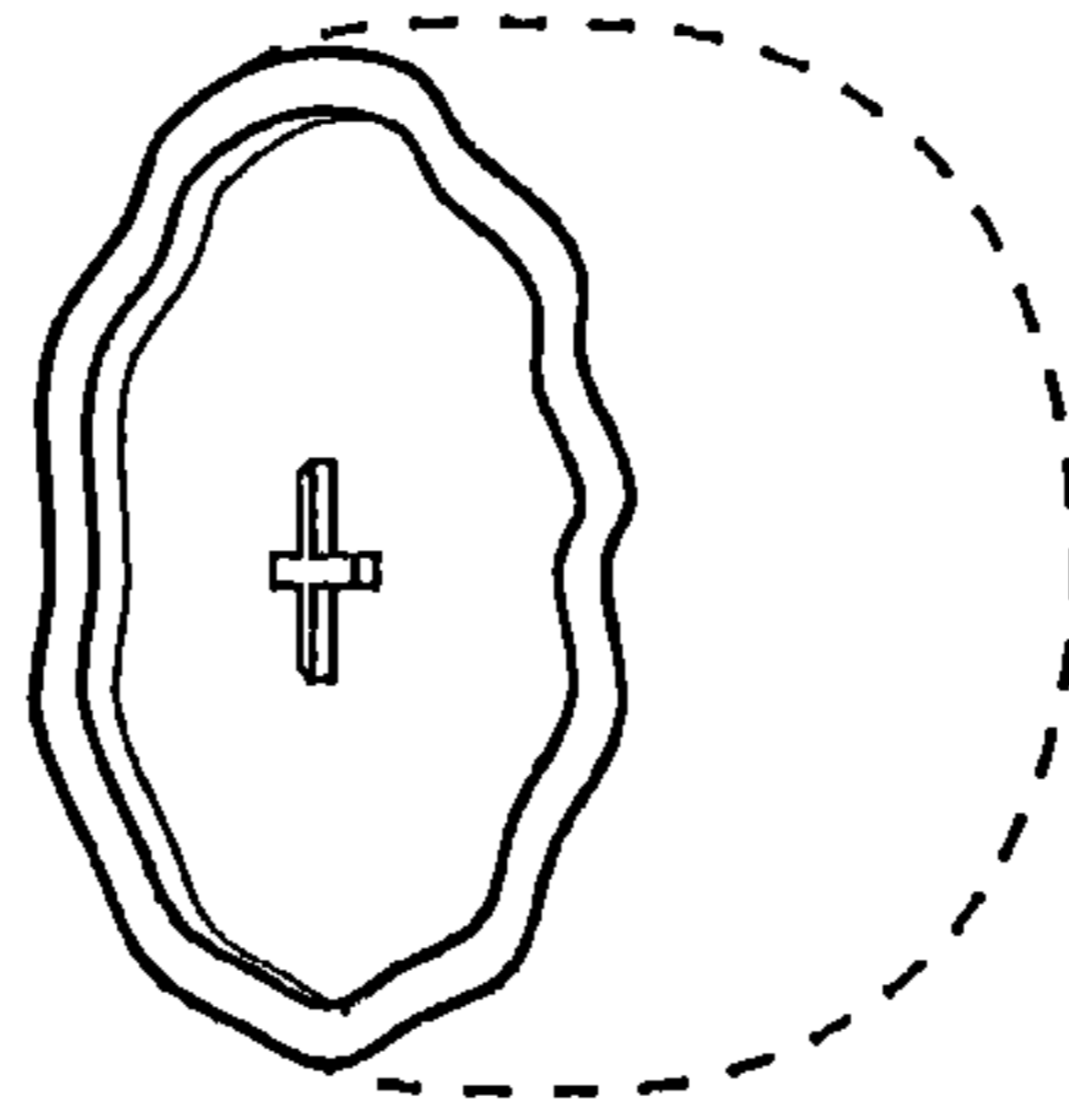

Fig. 377

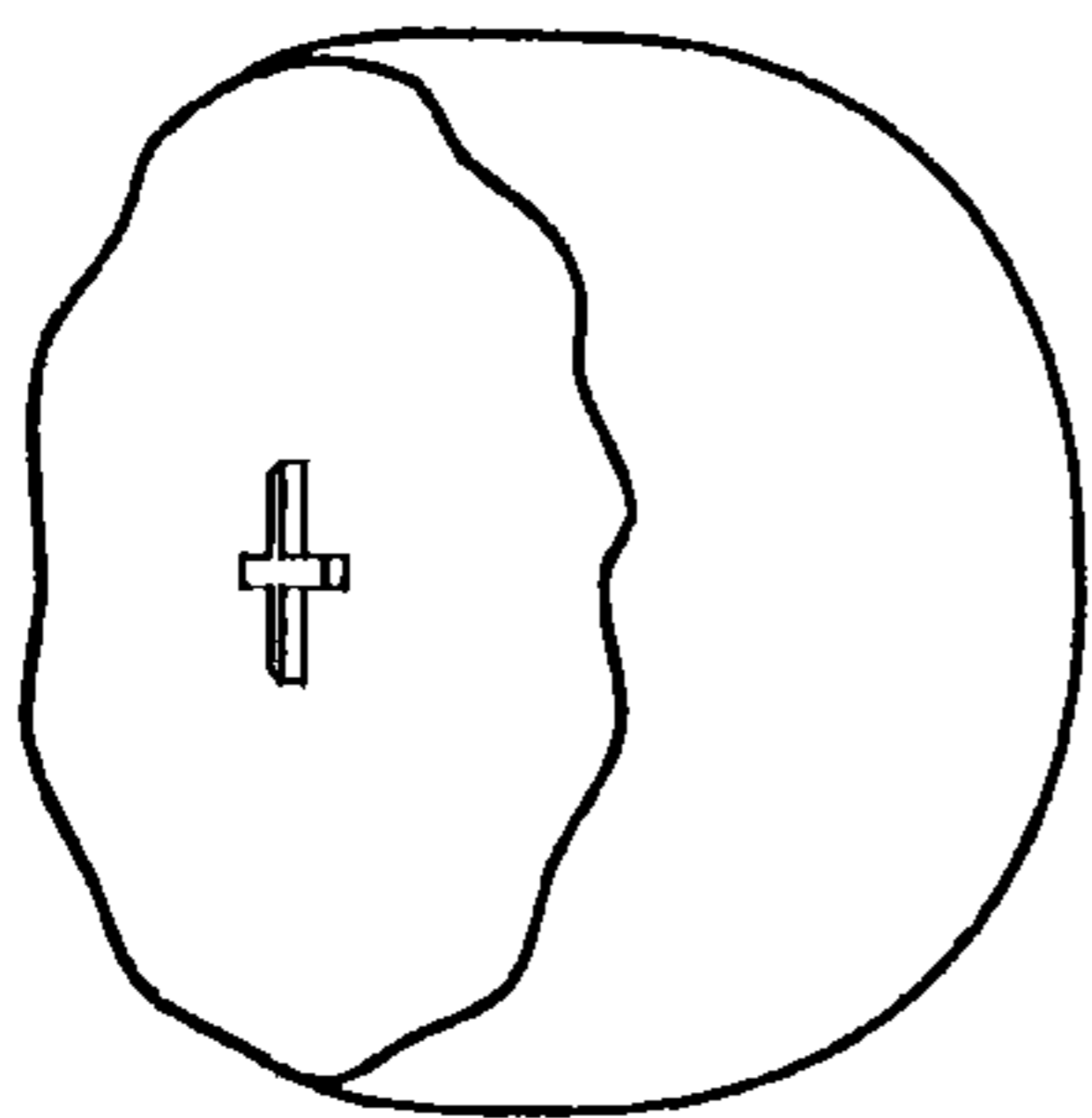

Fig. 373

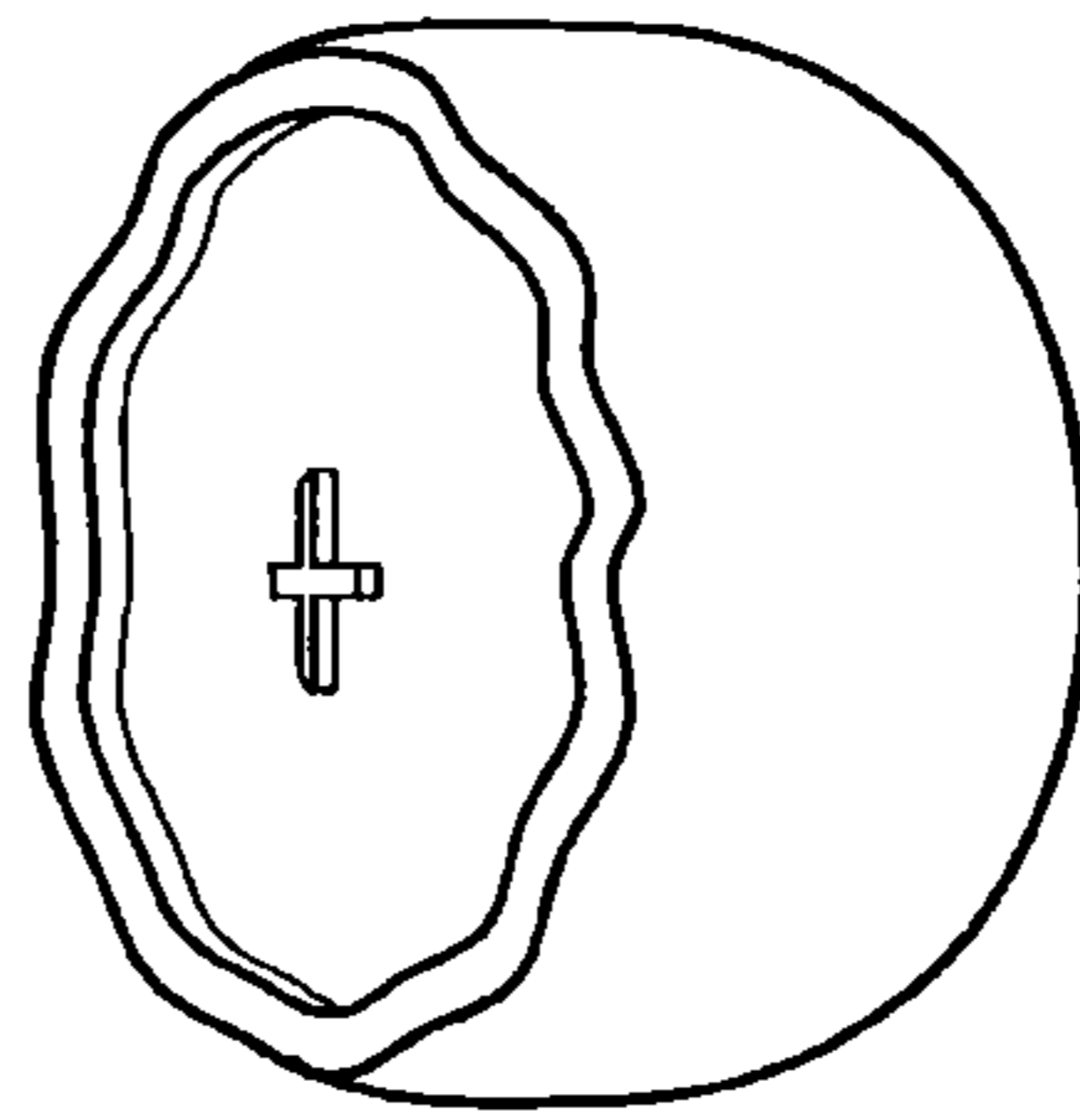

Fig. 376

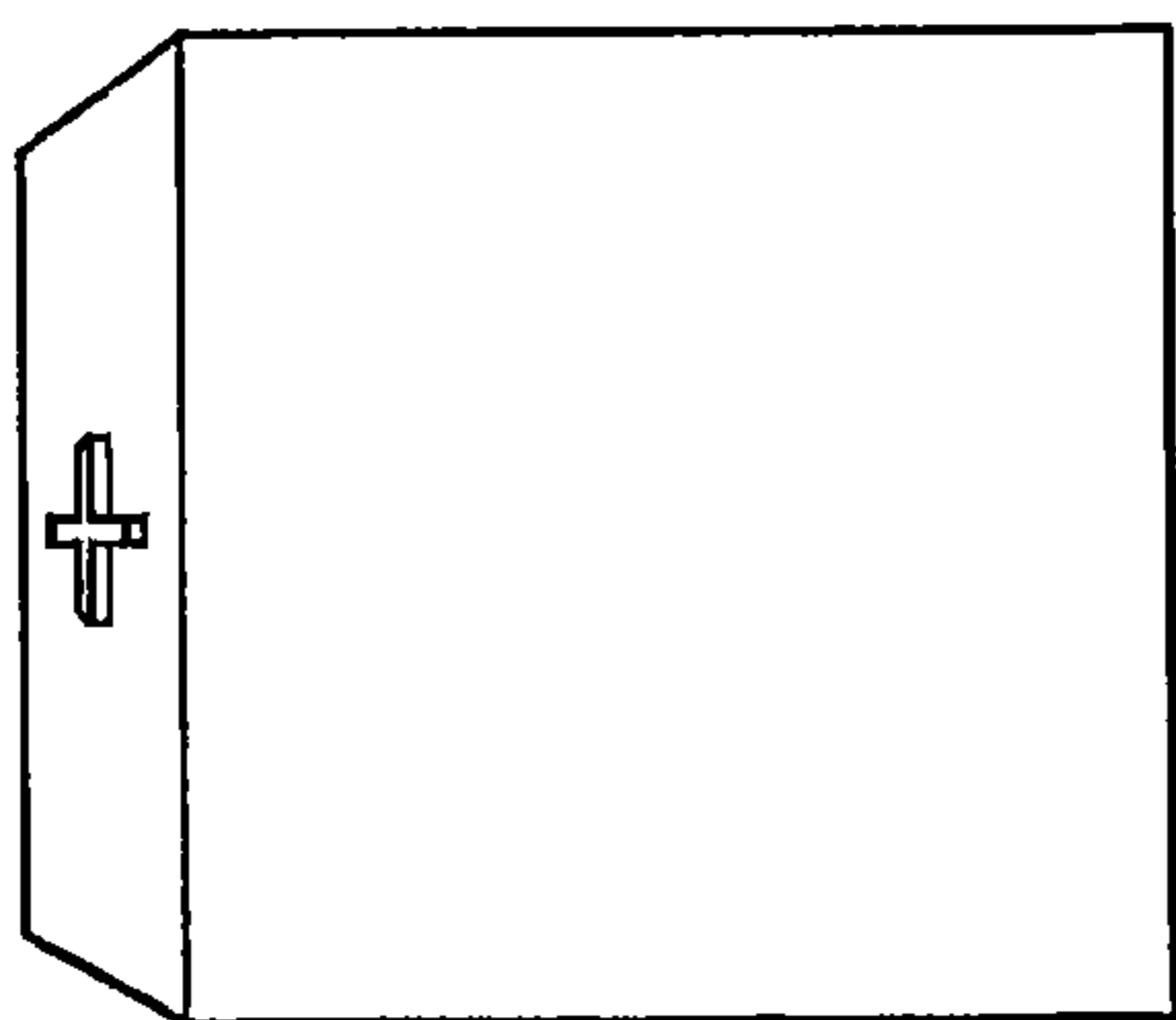

Fig. 379

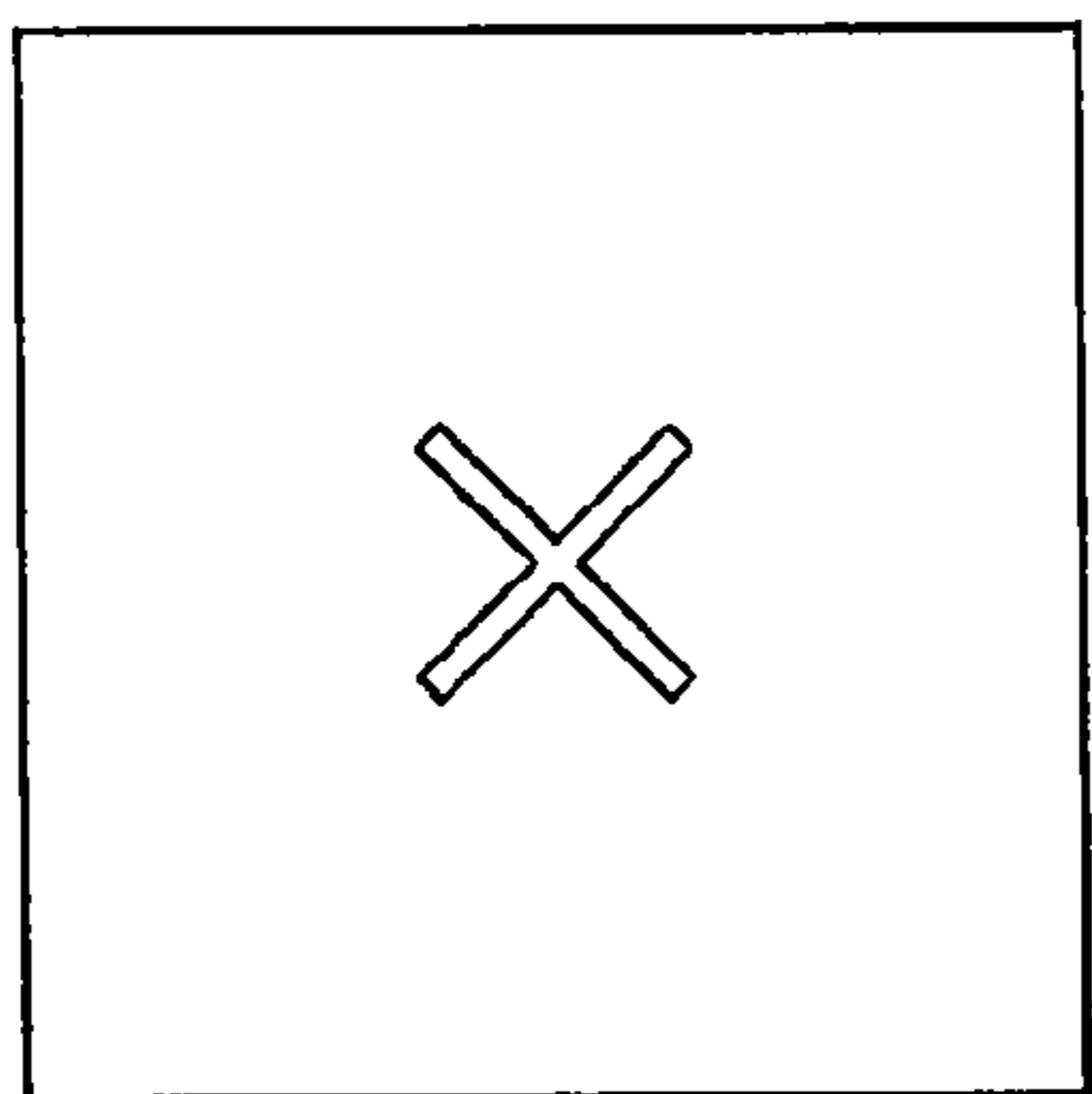

Fig. 380

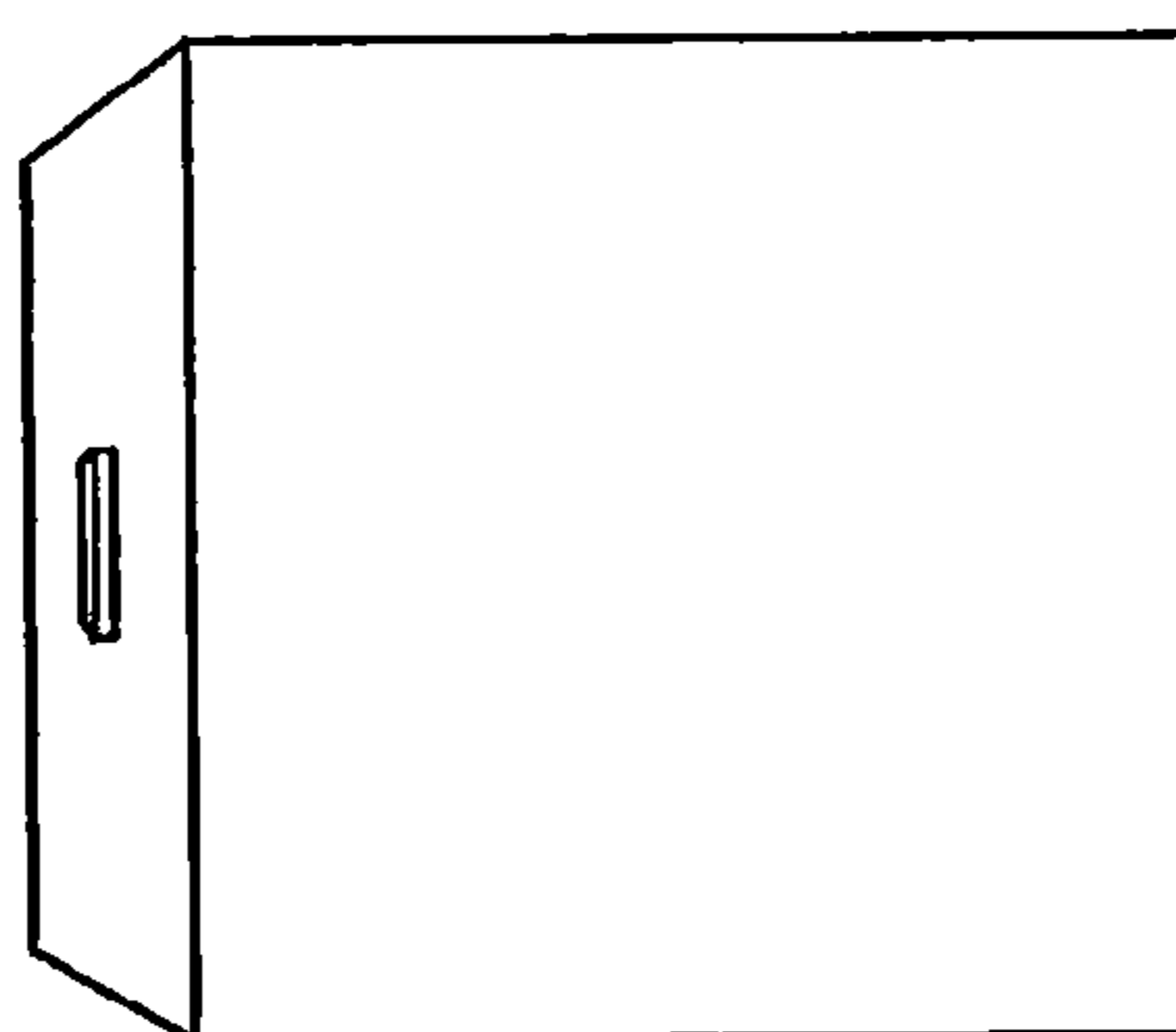

Fig. 381

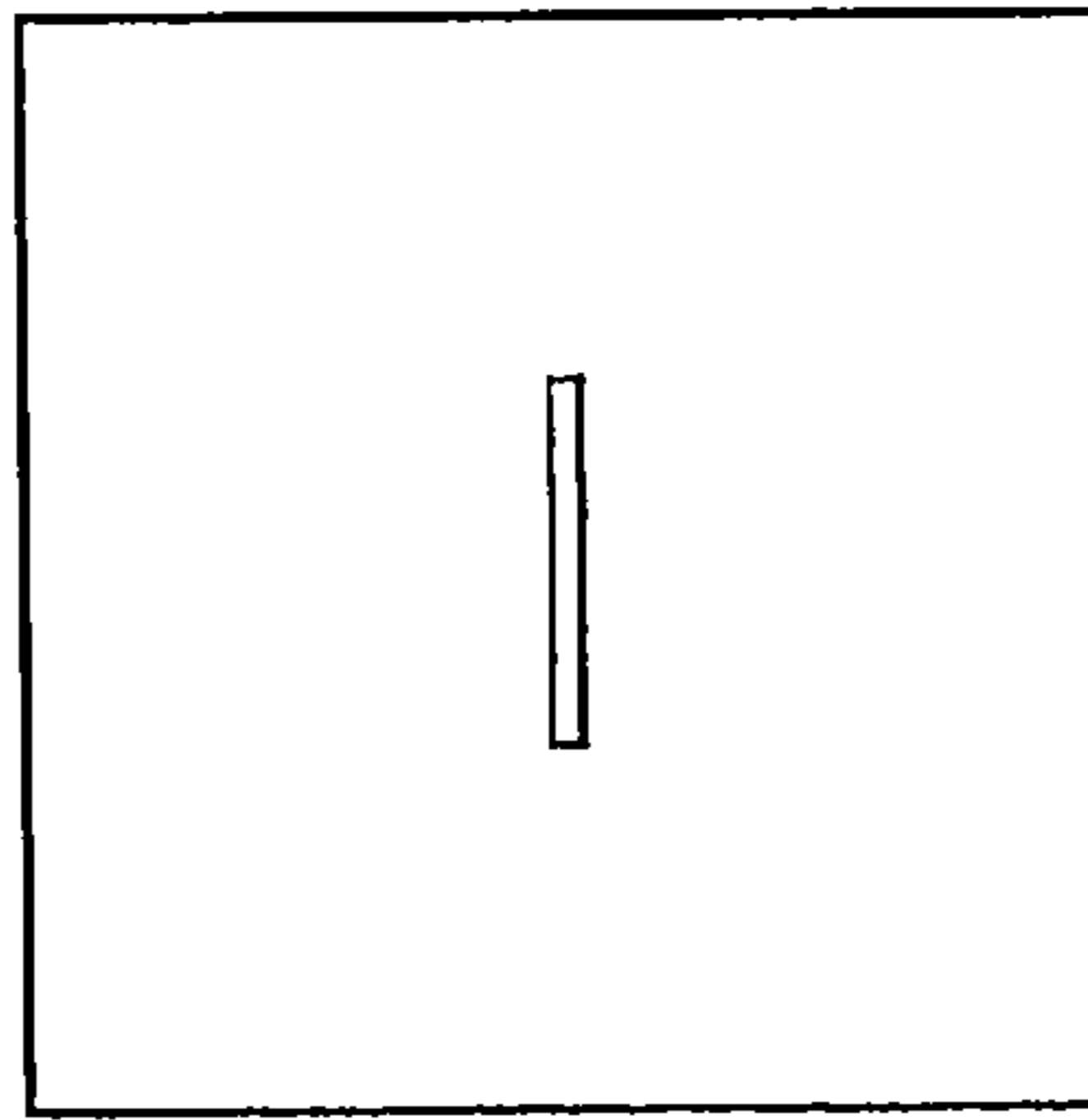

Fig. 382

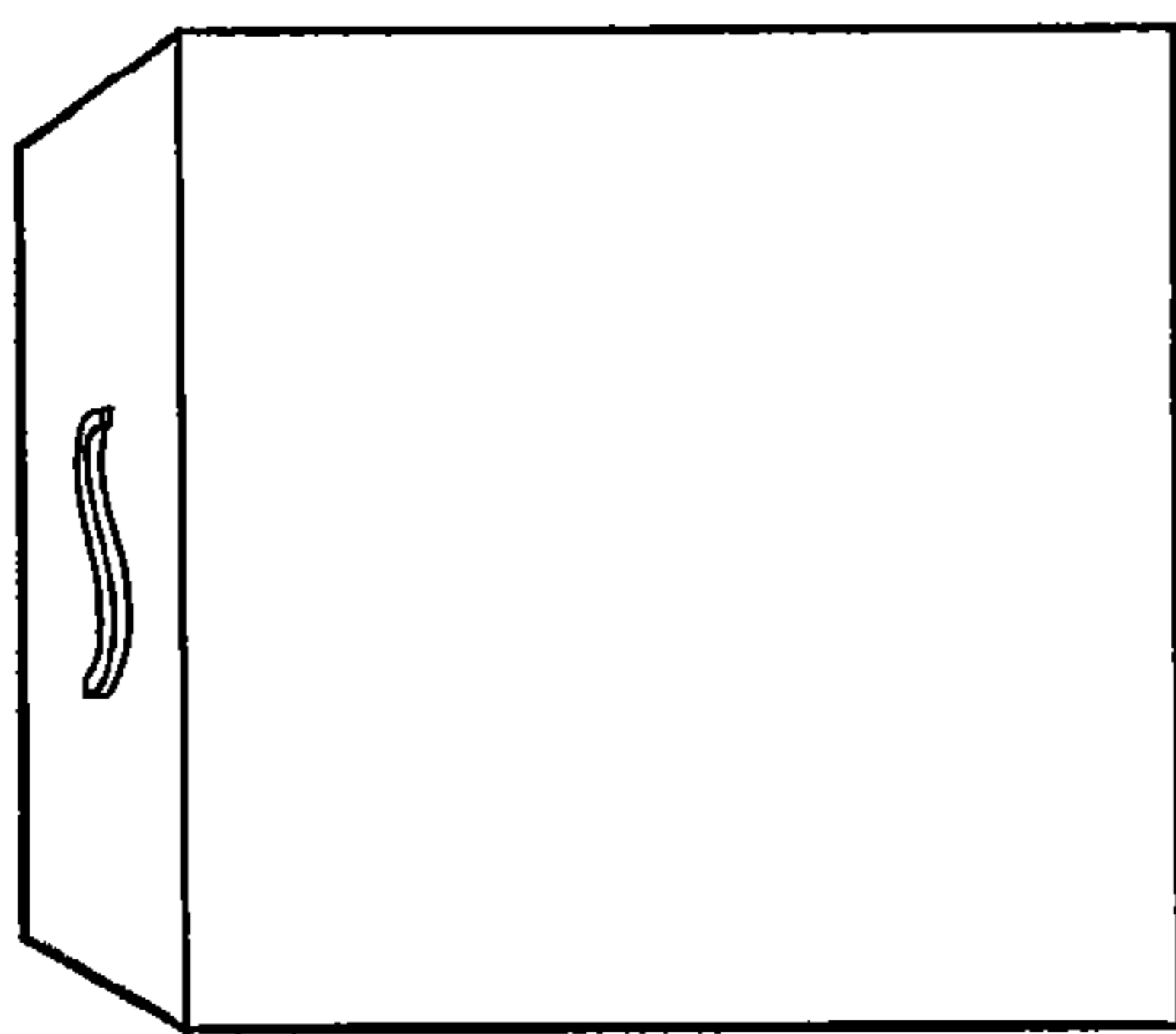

Fig. 383

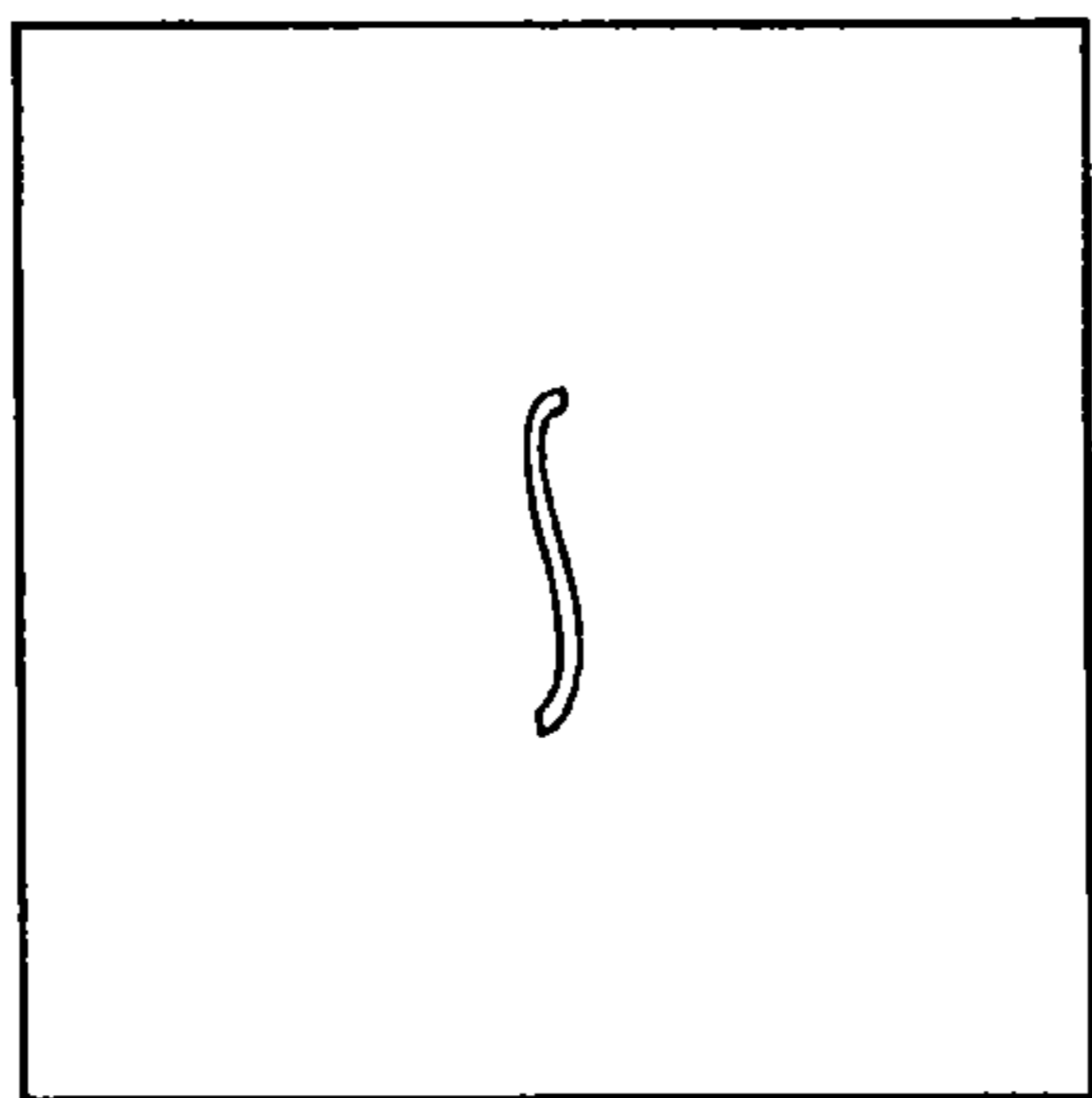

Fig. 384

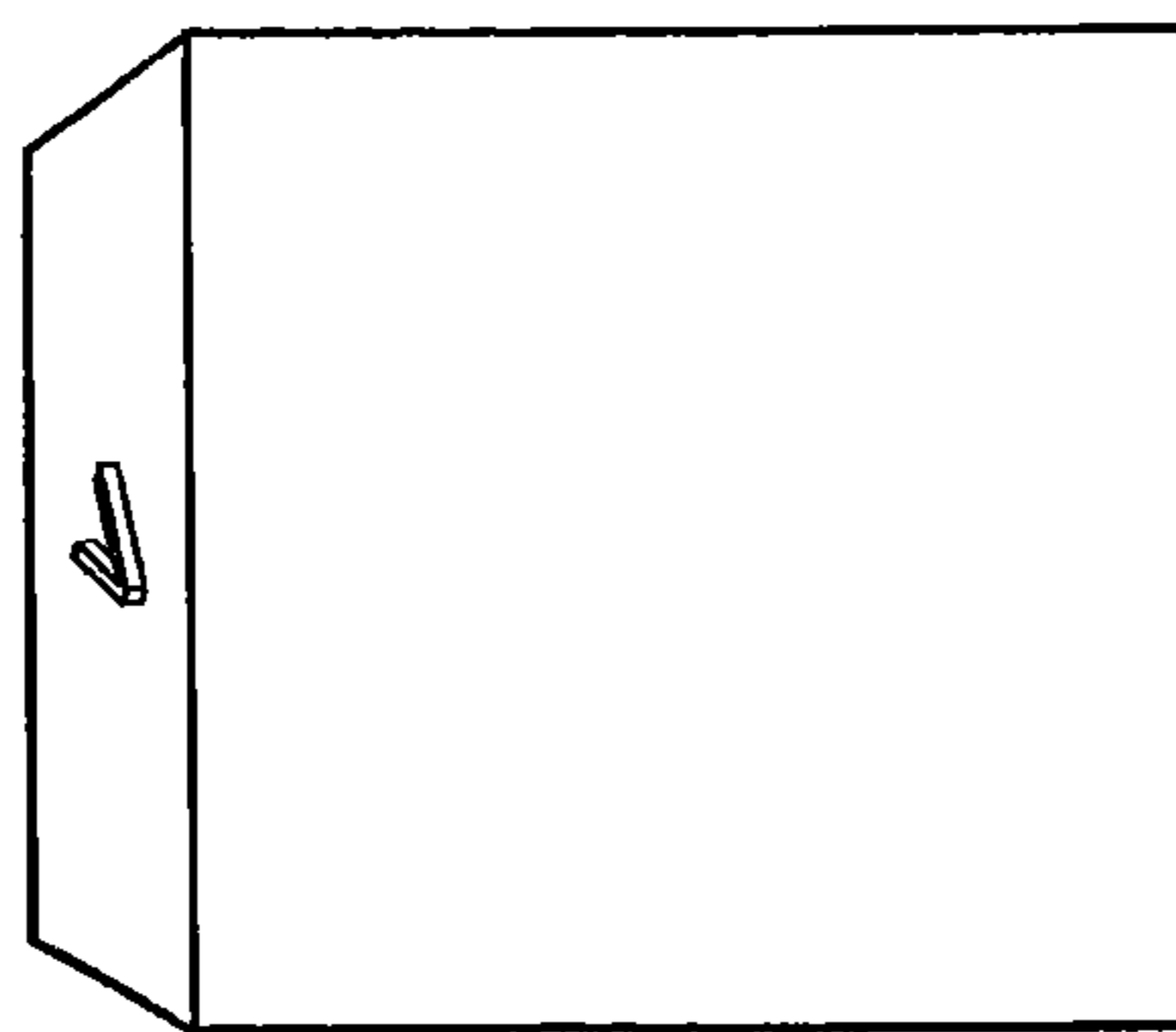

Fig. 385

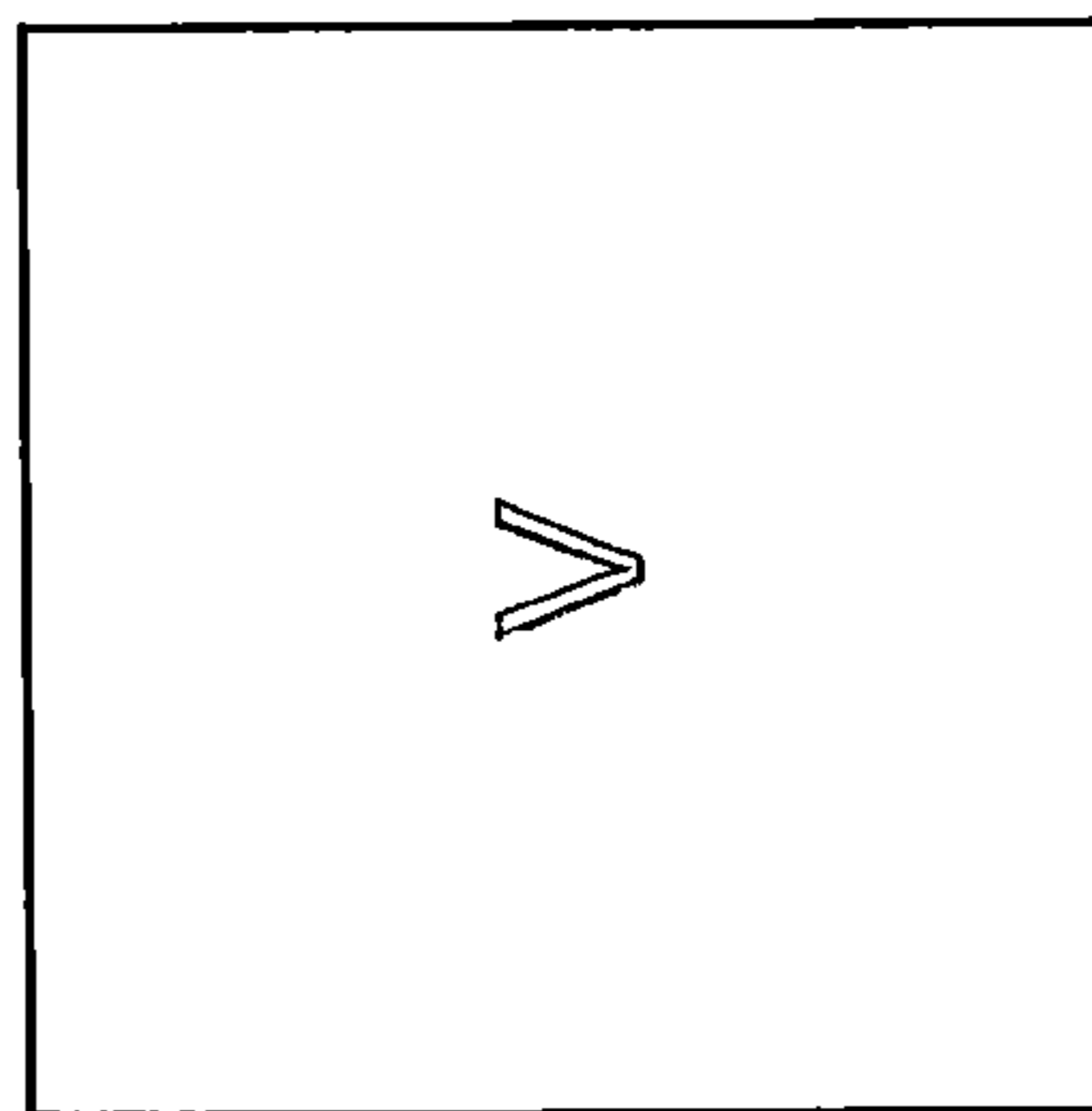

Fig. 386

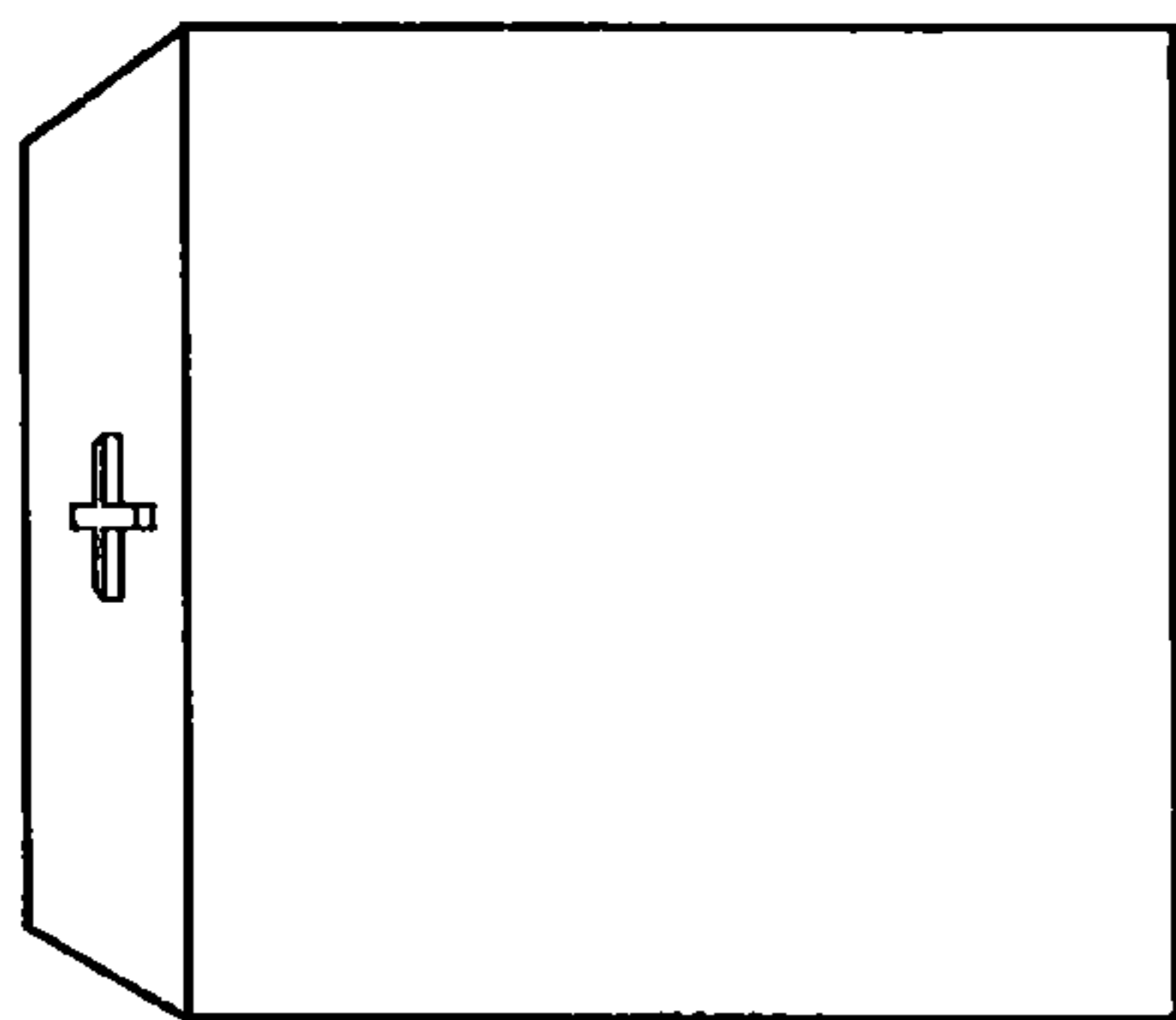

Fig. 387

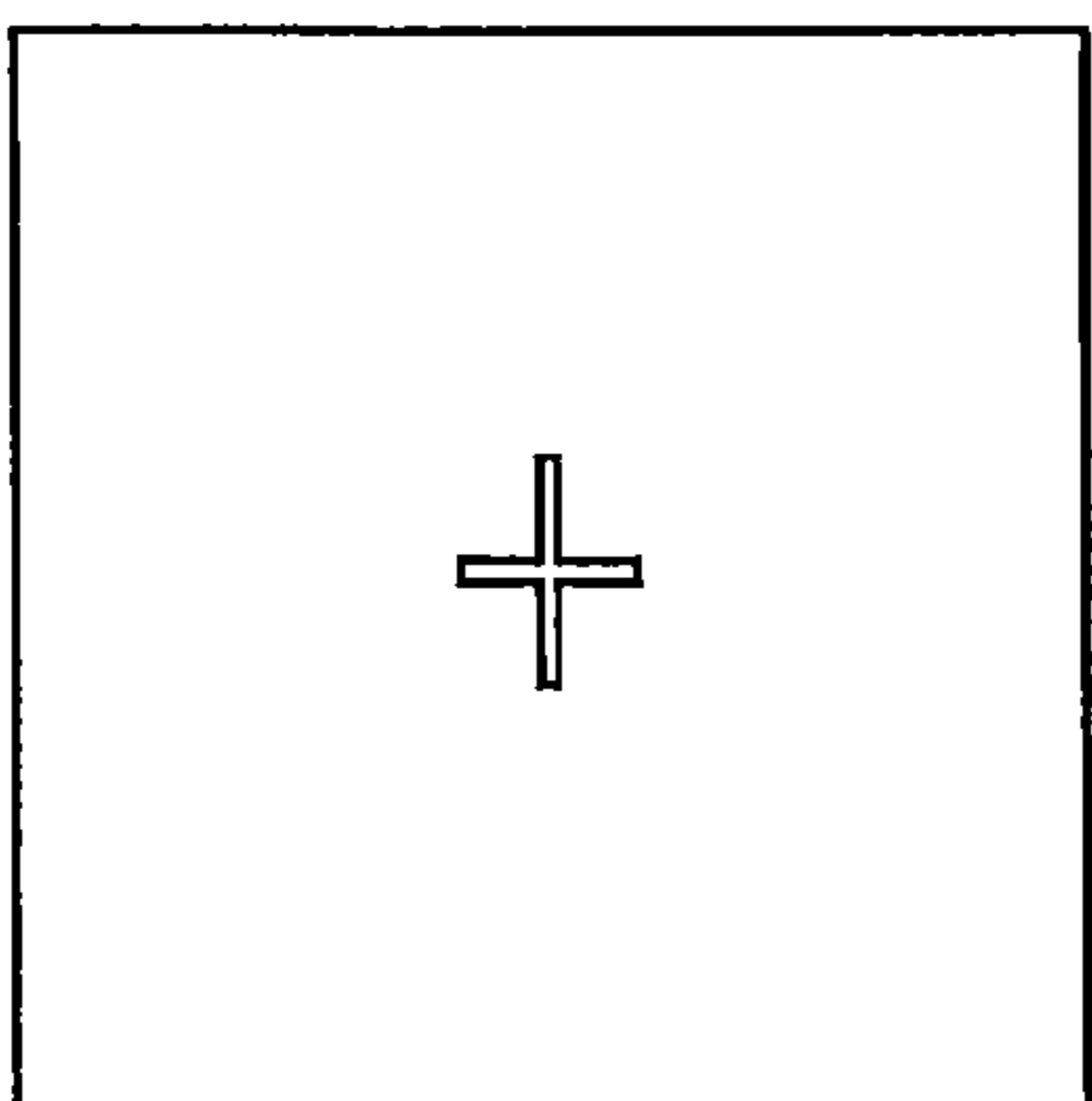

Fig. 388

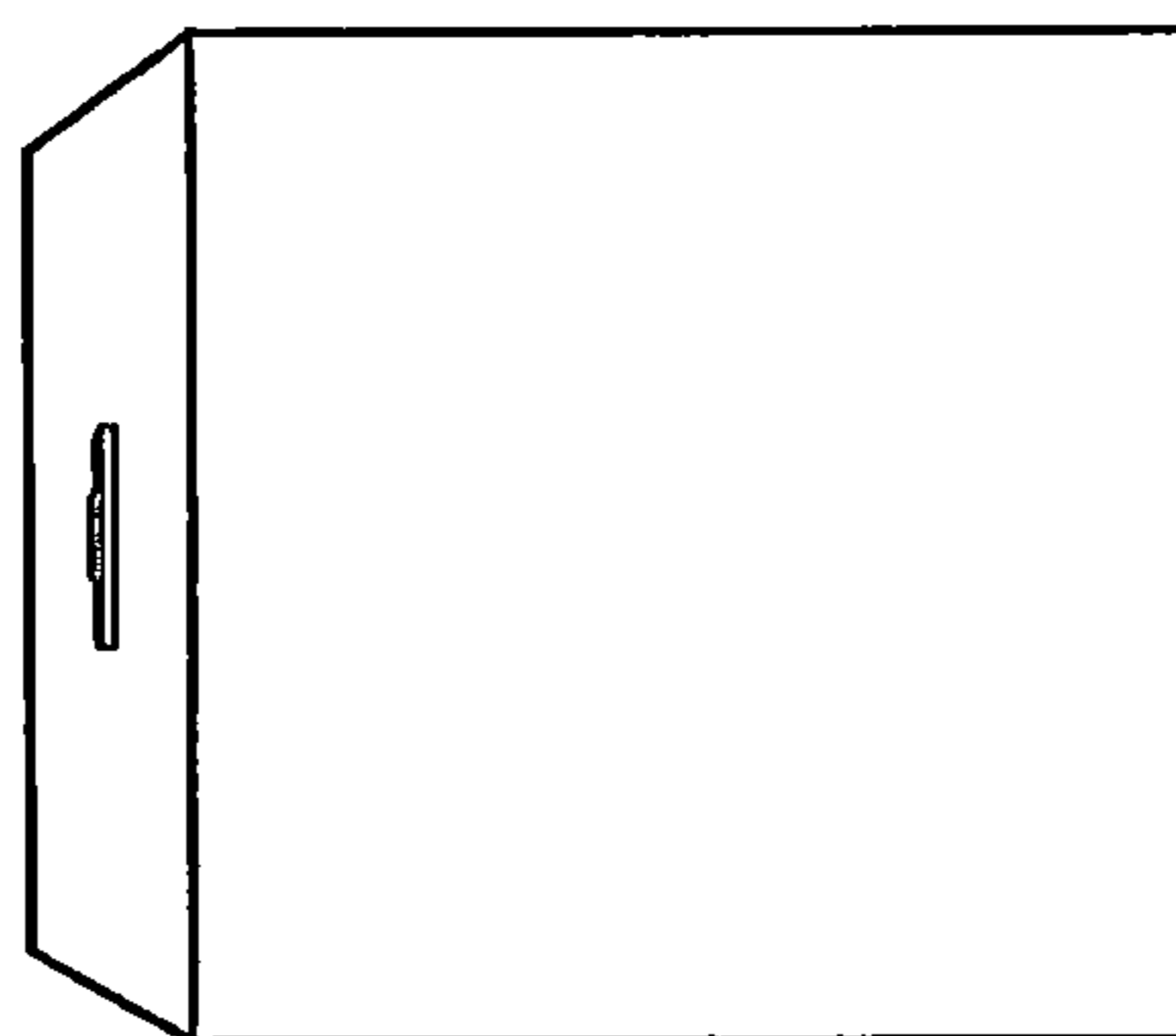

Fig. 389

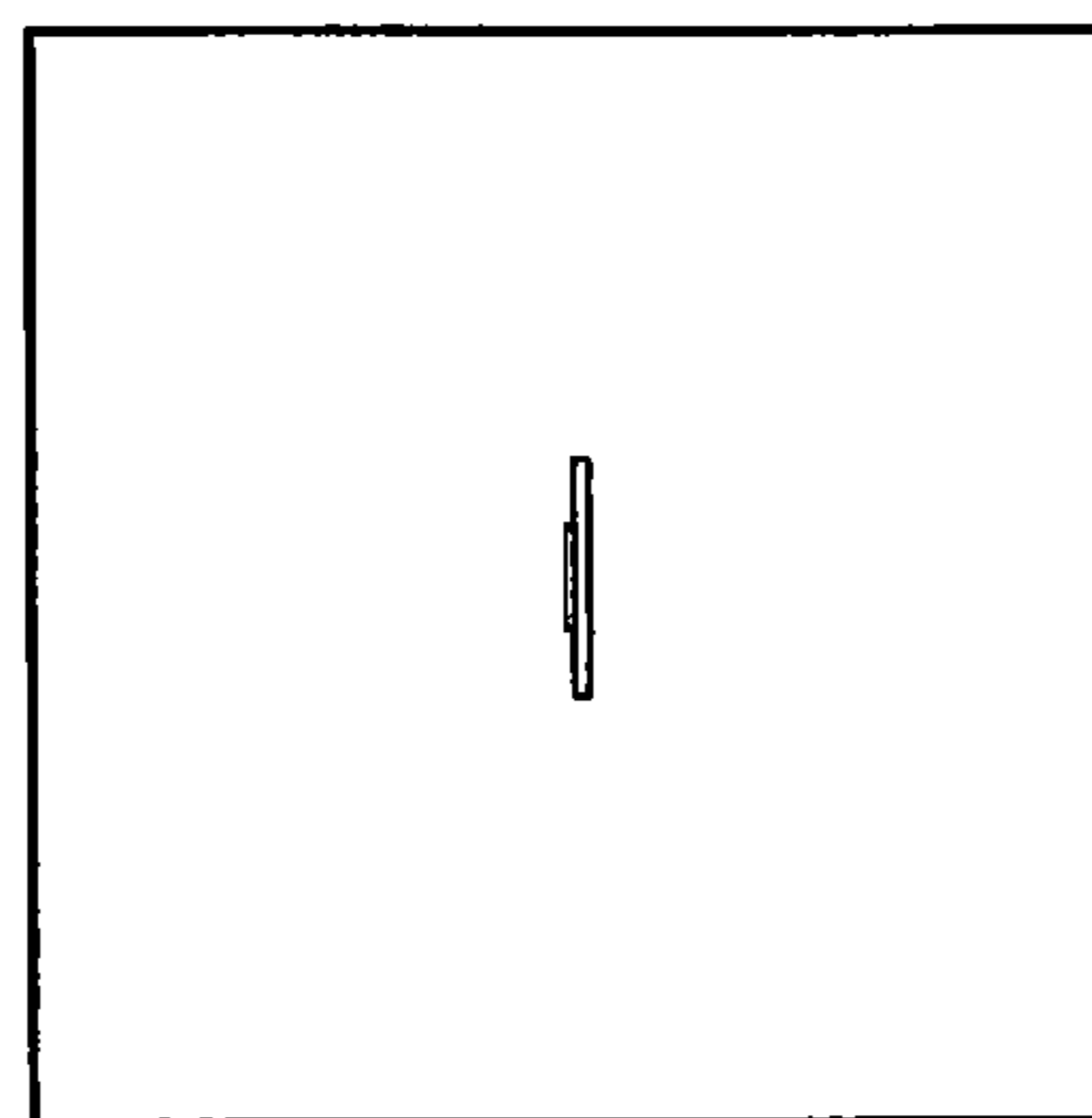

Fig. 390