



US00D740422S

(12) **United States Design Patent**  
**Herfort**

(10) **Patent No.:** **US D740,422 S**

(45) **Date of Patent:** **\*\* Oct. 6, 2015**

(54) **LANCING DEVICE**

(71) Applicant: **Gerresheimer Regensburg GmbH**,  
Regensburg (DE)

(72) Inventor: **Sergej Herfort**, Muenster (DE)

(73) Assignee: **Gerresheimer Regensburg GMBH**,  
Regensburg (DE)

(\*\*) Term: **14 Years**

(21) Appl. No.: **29/459,172**

(22) Filed: **Jun. 26, 2013**

(30) **Foreign Application Priority Data**

Jun. 11, 2013 (EP) ..... 002253393

(51) **LOC (10) Cl.** ..... **24-02**

(52) **U.S. Cl.**  
USPC ..... **D24/147**

(58) **Field of Classification Search**  
USPC ..... D7/649; D8/14.1, 29.1, 92, 93, 95, 97,  
D8/98, 99; D19/110, 115; D24/130, 133,  
D24/146, 147, 150, 151; 30/151, 162, 338,  
30/339; 606/4, 5, 6, 44, 107, 166  
See application file for complete search history.

(56) **References Cited**

**U.S. PATENT DOCUMENTS**

D493,532 S \* 7/2004 Levaughn et al. .... D24/146  
D533,274 S \* 12/2006 Visconti et al. .... D24/133

D590,502 S \* 4/2009 Geisser et al. .... D24/133  
D621,042 S \* 8/2010 Ruf ..... D24/146  
D625,818 S \* 10/2010 Khalil et al. .... D24/146  
D628,293 S \* 11/2010 Ruf ..... D24/146  
D628,695 S \* 12/2010 Ruf ..... D24/146  
D631,960 S \* 2/2011 Myers ..... D24/133  
D638,273 S \* 5/2011 Dunlap et al. .... D8/99  
8,398,664 B2 \* 3/2013 Lamps et al. .... 606/181  
D697,205 S \* 1/2014 Schneider et al. .... D24/113  
2006/0100656 A1 \* 5/2006 Olson et al. .... 606/181  
2014/0155926 A1 \* 6/2014 Volkmuth et al. .... 606/182

\* cited by examiner

*Primary Examiner* — Robert M Spear

*Assistant Examiner* — Marissa J Cash

(74) *Attorney, Agent, or Firm* — Lathrop & Gage LLP

(57) **CLAIM**

We claim the ornamental design for a lancing device, as shown and described.

**DESCRIPTION**

FIG. 1 shows the perspective side view of the lancing device from the left; the perspective side view from the right looks the same, respectively;  
FIG. 2 shows the top view thereof;  
FIG. 3 shows the side view from the left; the side view from the right looks the same, respectively, thereof;  
FIG. 4 shows the bottom view, thereof;  
FIG. 5 shows the front view, thereof; and,  
FIG. 6 shows the back view, thereof.

**1 Claim, 6 Drawing Sheets**

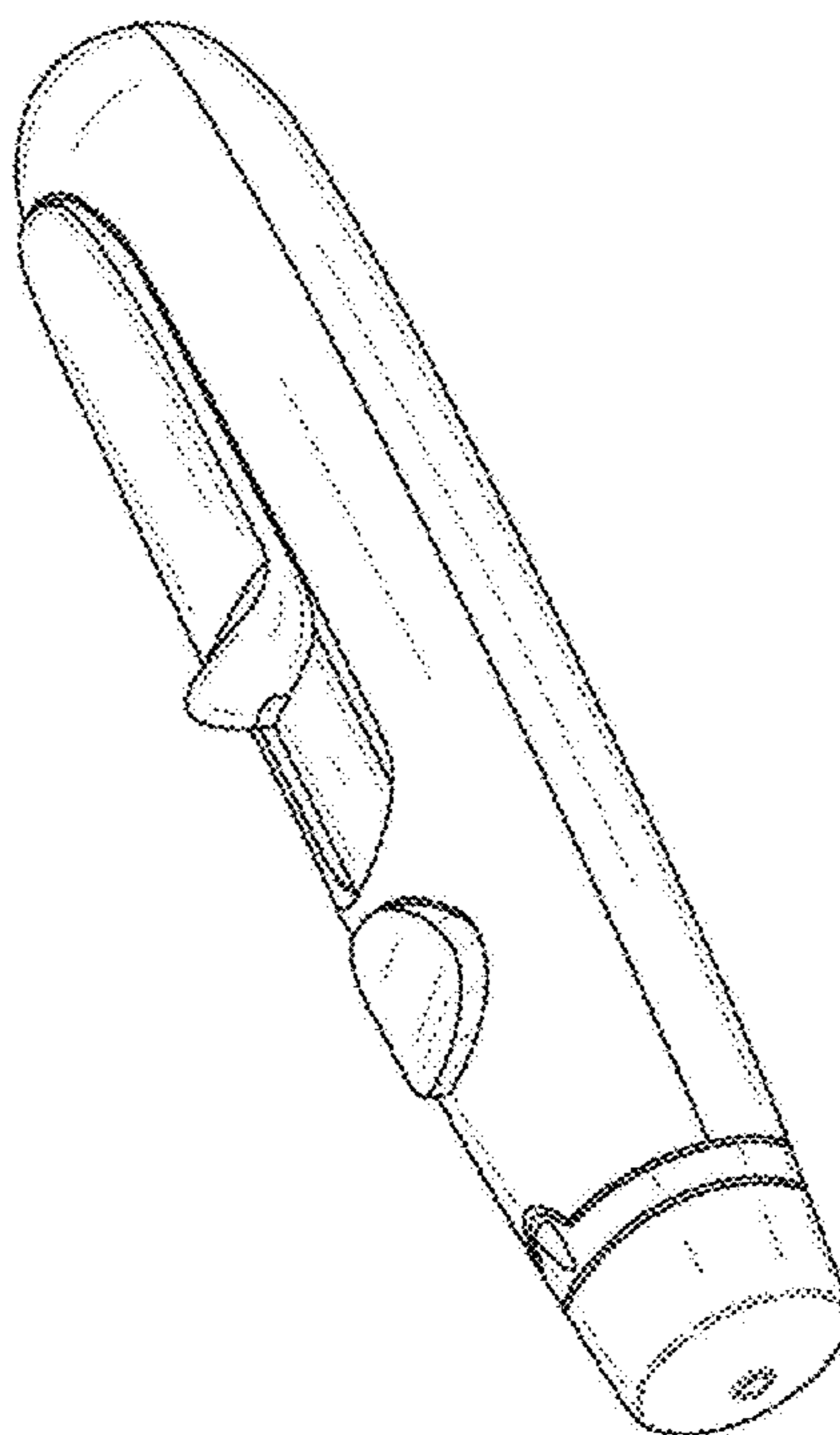

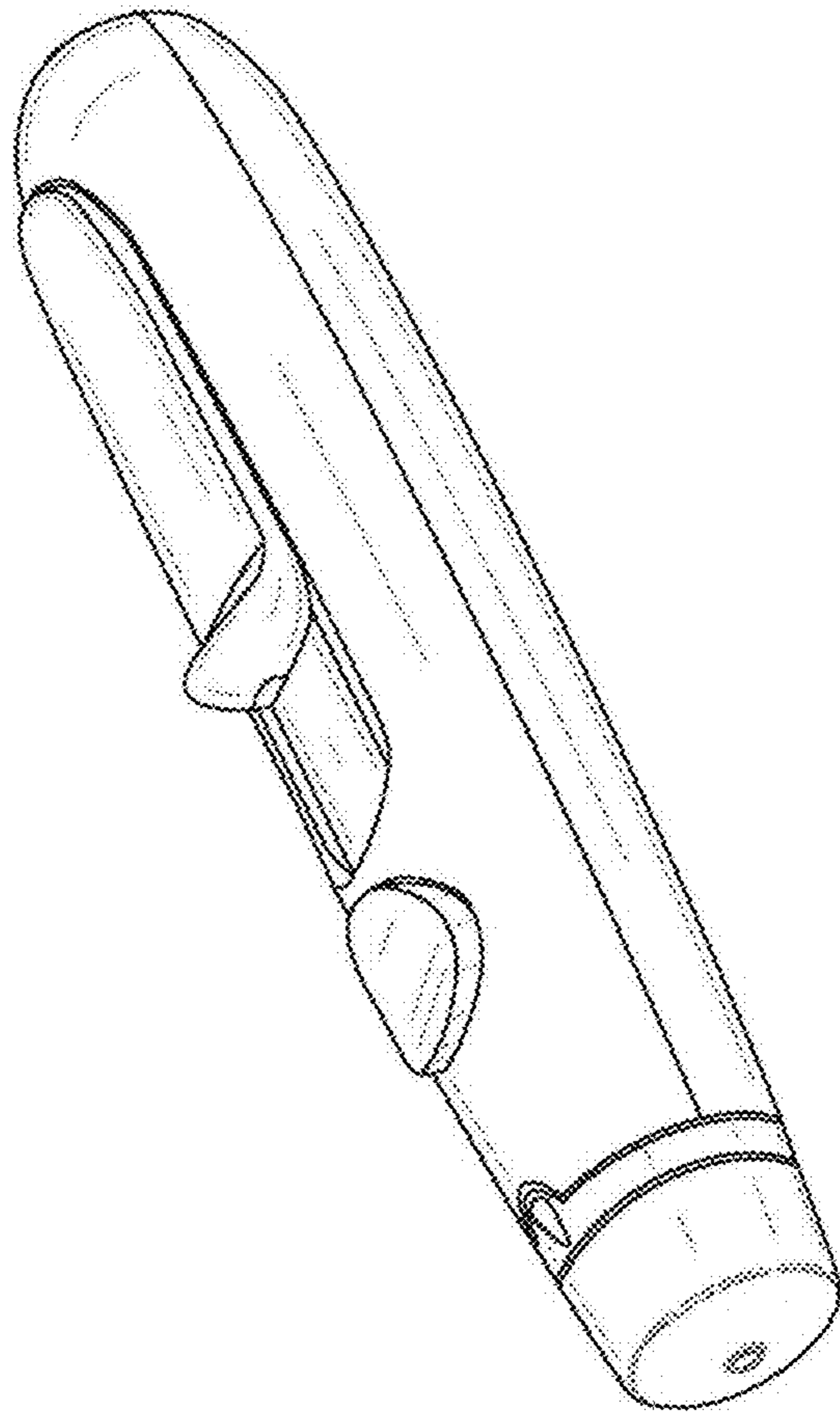

FIG. 1

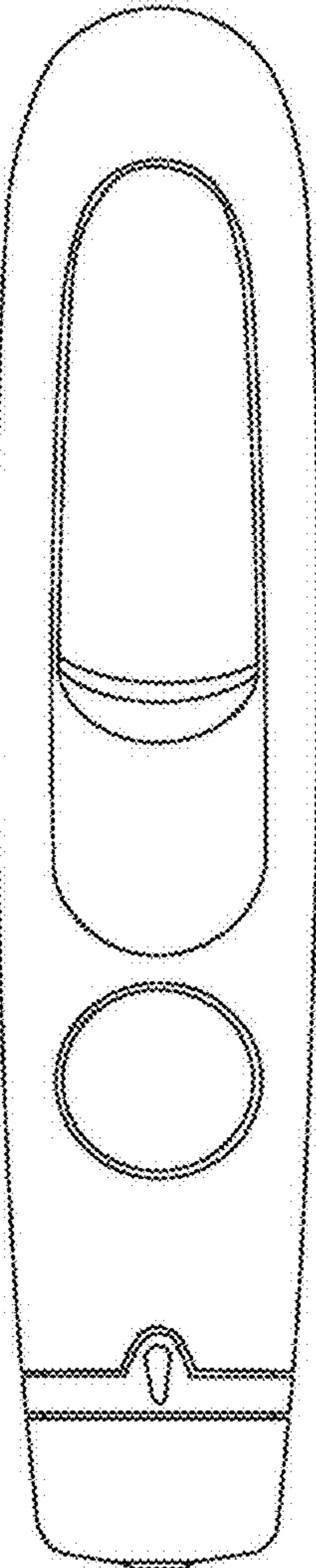

FIG. 2

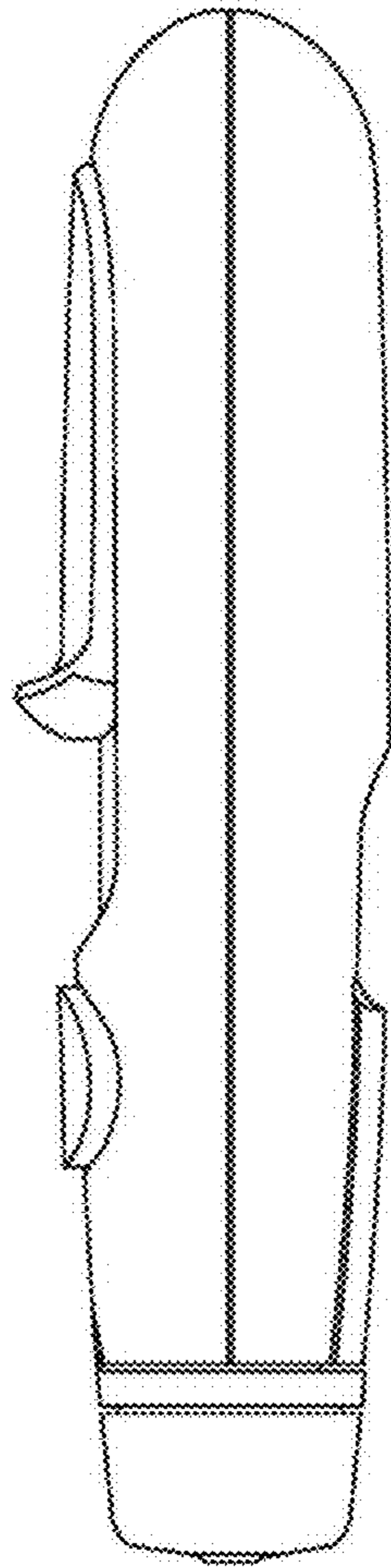

FIG. 3

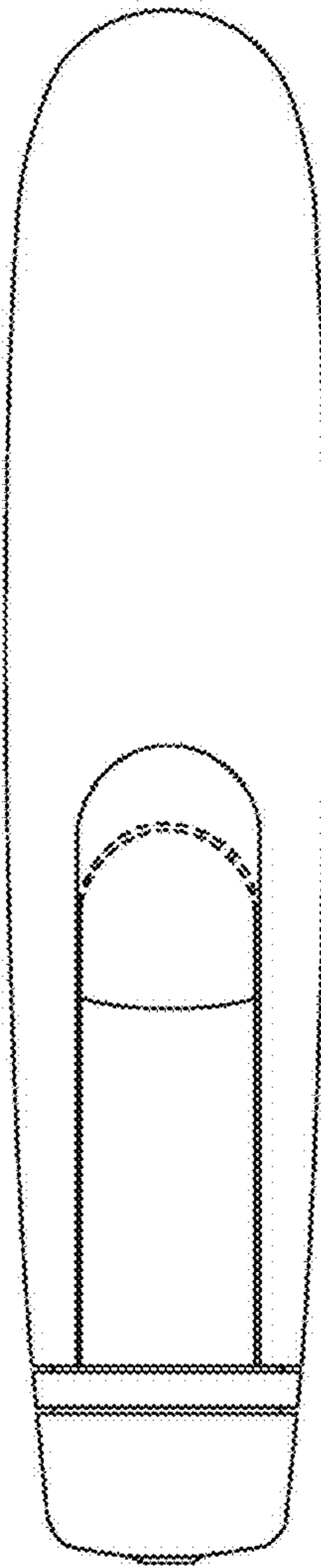

FIG. 4

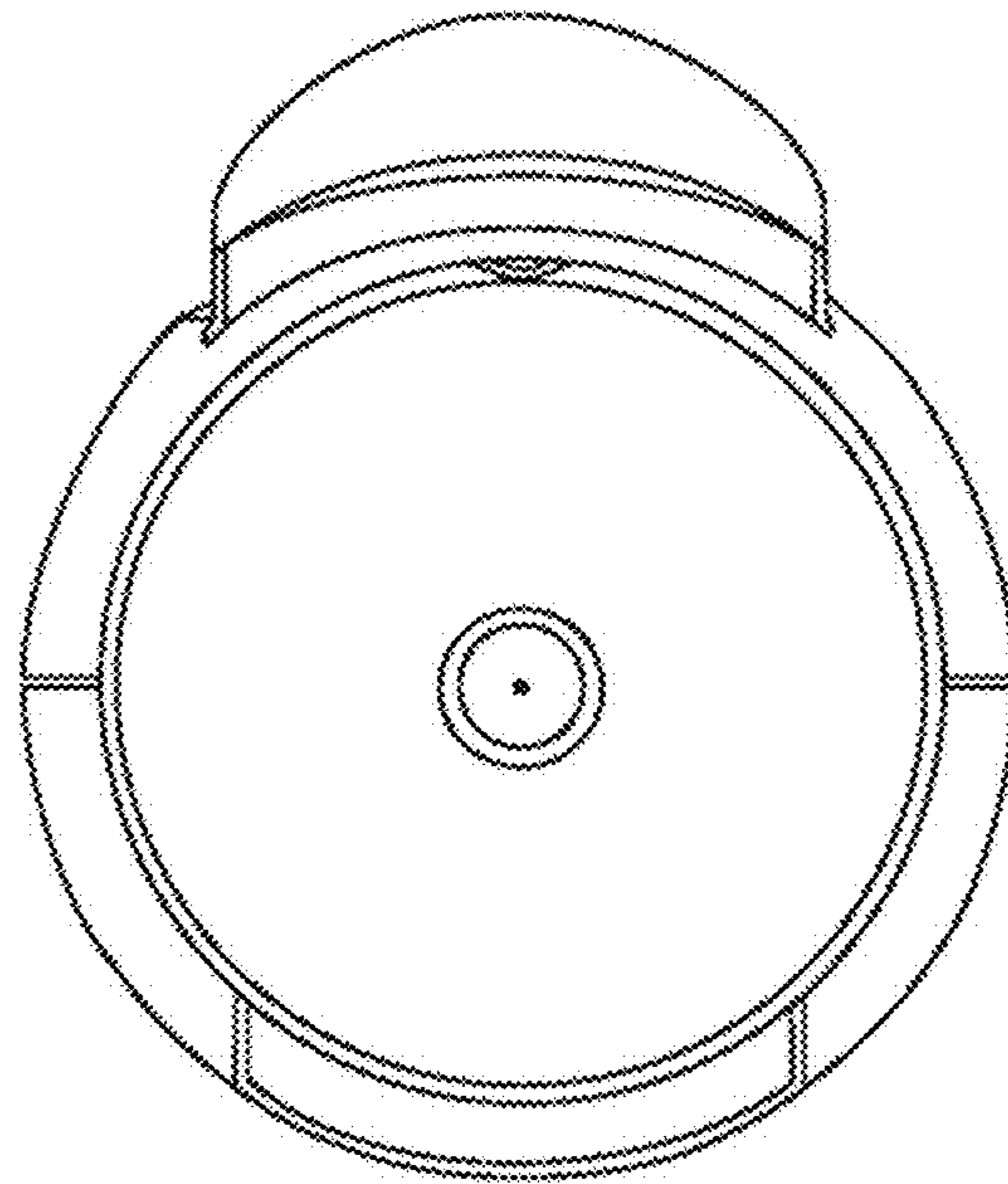

FIG. 5

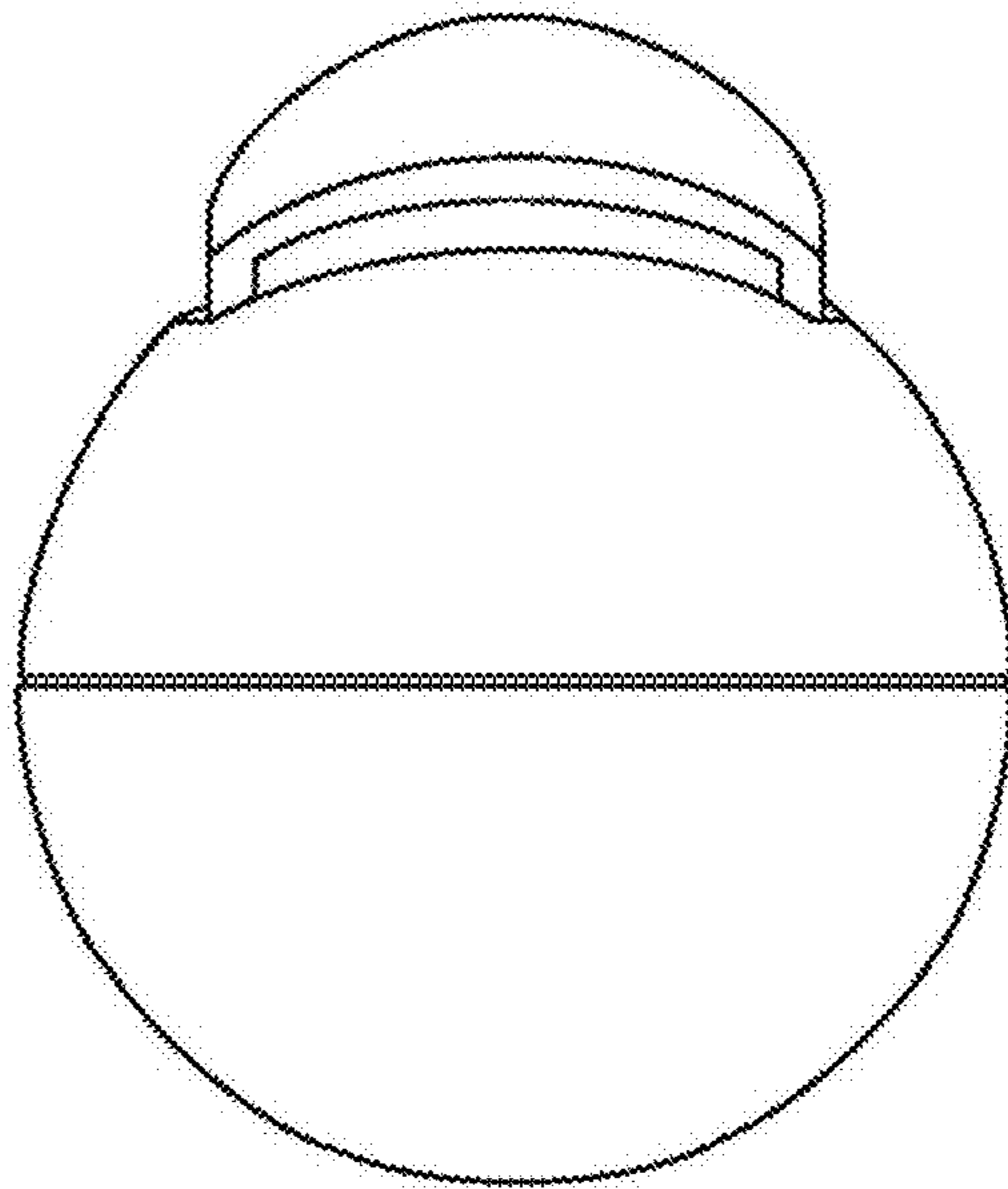

FIG. 6