



US00D740362S

(12) **United States Design Patent**
Koo

(10) **Patent No.:** **US D740,362 S**

(45) **Date of Patent:** **** Oct. 6, 2015**

(54) **PEN**

(75) Inventor: **Daniel Koo**, Arcadia, CA (US)

(73) Assignee: **ECOVERTE, LLC.**, Arcadia, CA (US)

(**) Term: **14 Years**

(21) Appl. No.: **29/413,045**

(22) Filed: **Feb. 9, 2012**

(51) **LOC (10) Cl.** **19-06**

(52) **U.S. Cl.**
USPC **D19/171; D19/916**

(58) **Field of Classification Search**
USPC D14/411; D19/35, 36, 41-51, 54-58,
D19/115-204; 24/11 F, 11 P, 11 R; 401/52,
401/99-109, 192, 195, 196
CPC B43K 7/00; B43K 7/08; B43K 7/10
See application file for complete search history.

(56) **References Cited**

U.S. PATENT DOCUMENTS

D425,559 S *	5/2000	Beneyto	D19/51
D523,081 S *	6/2006	Pellissa Beneyto	D19/51
D540,386 S *	4/2007	Qiu	D19/51
D589,559 S *	3/2009	Slemp	D19/51
D596,228 S *	7/2009	Koch	D19/41
D611,538 S *	3/2010	Zhou	D19/51

D623,224 S *	9/2010	Hsu	D19/48
D628,637 S *	12/2010	Xiao	D19/48
D633,943 S *	3/2011	Stukenkemper	D19/51
D663,770 S *	7/2012	Koch	D19/47
D672,816 S *	12/2012	Li	D19/51
D691,197 S *	10/2013	Casciotti et al.	D19/174

* cited by examiner

Primary Examiner — Elizabeth Albert

(74) *Attorney, Agent, or Firm* — Barceló, Harrison & Walker, LLP.

(57) **CLAIM**

The ornamental design for a pen, as shown and described.

DESCRIPTION

FIG. 1 depicts an exploded perspective view of a pen showing my new design.

FIG. 2 depicts a top view of the pen.

FIG. 3 depicts a front view of the pen.

FIG. 4 depicts a right side view of the pen.

FIG. 5 depicts a right side view of the blind cap shown without the rest of the pen for convenience of illustration.

FIG. 6 depicts a right side view of the rear tube and clip shown without the rest of the pen for convenience of illustration.

FIG. 7 depicts a right side view of the barrel shown without the rest of the pen for convenience of illustration; and,

FIG. 8 depicts a right side view of the tip section shown without the rest of the pen for convenience of illustration.

1 Claim, 5 Drawing Sheets

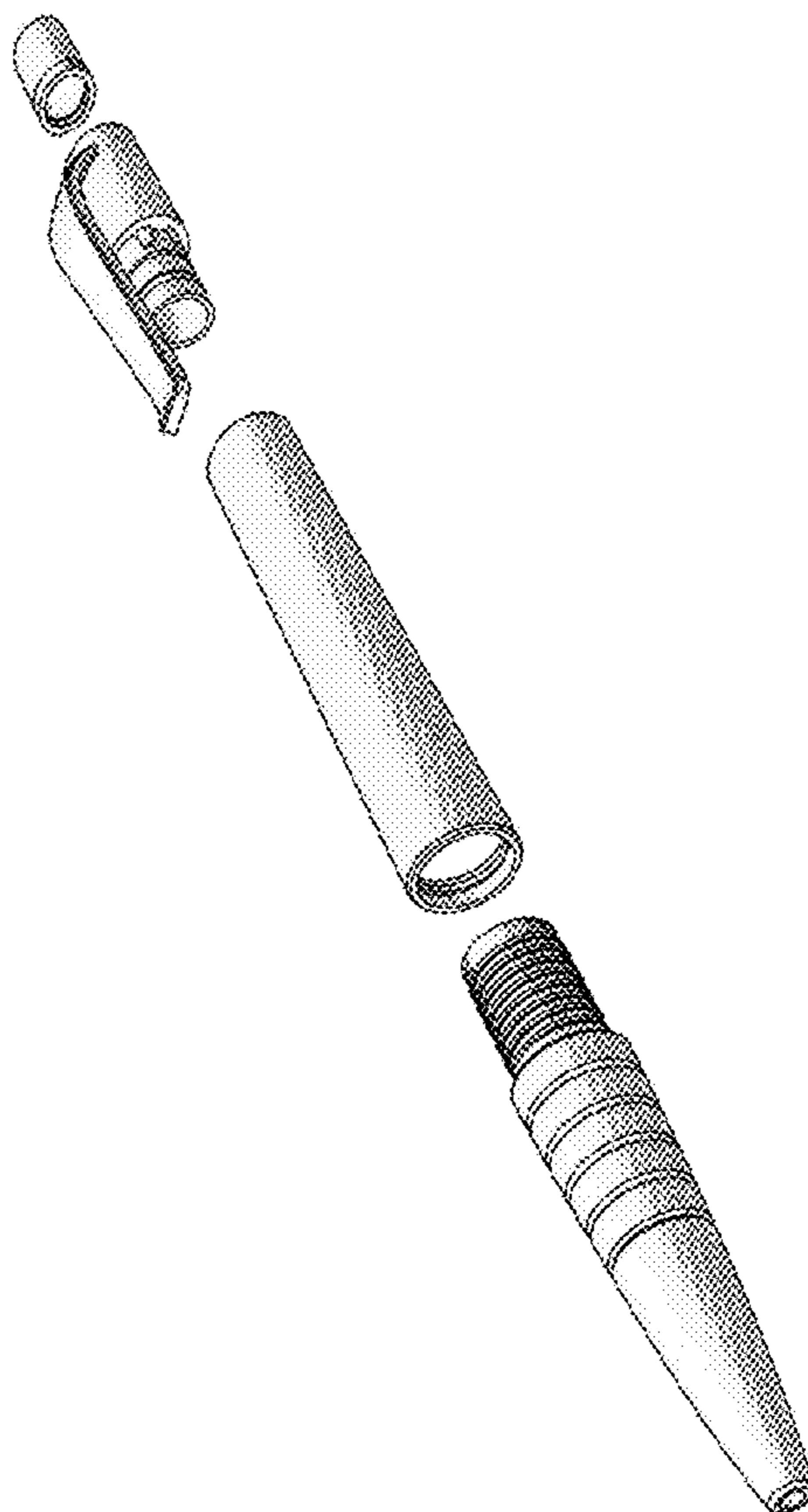

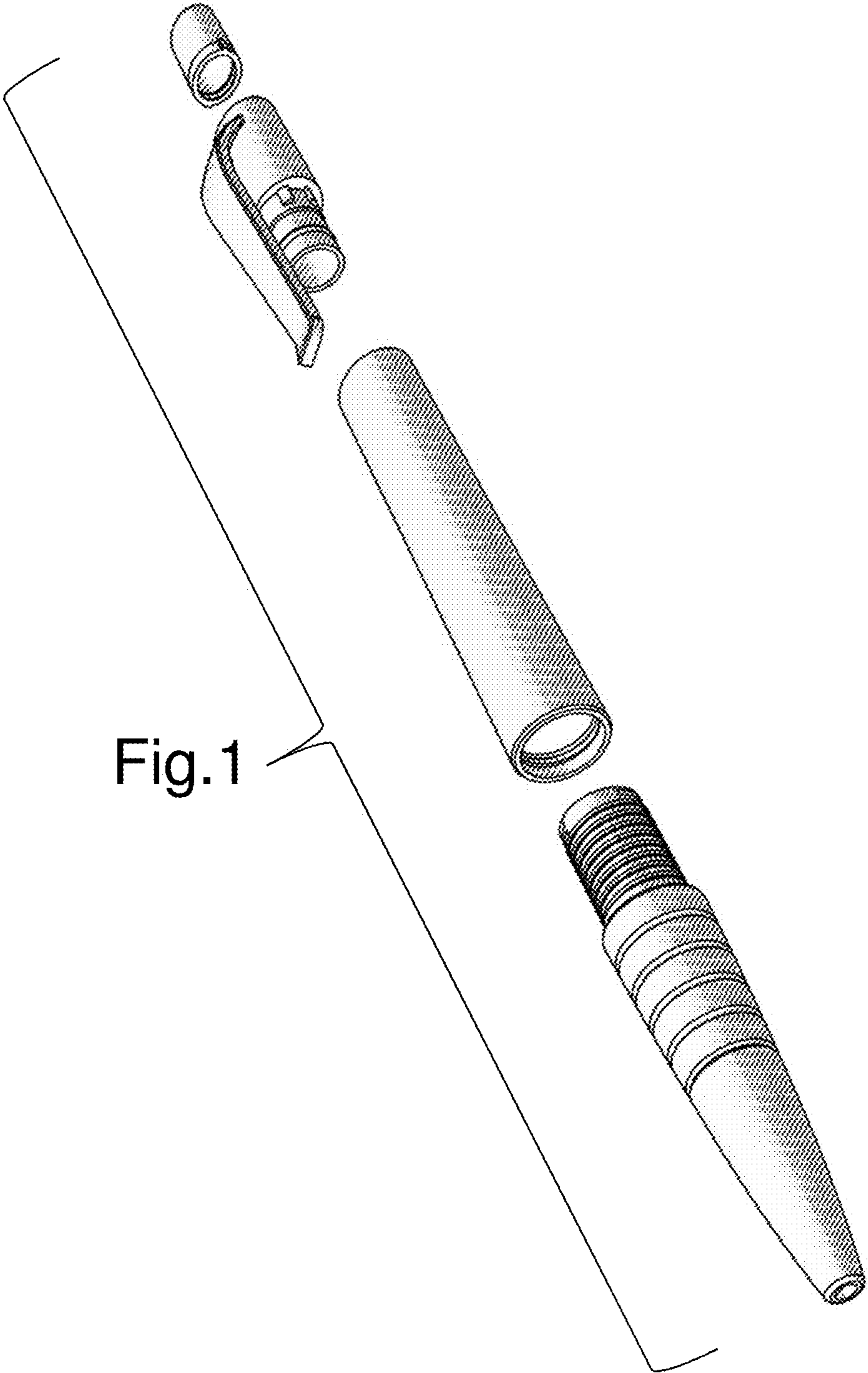

Fig. 1

Fig.2

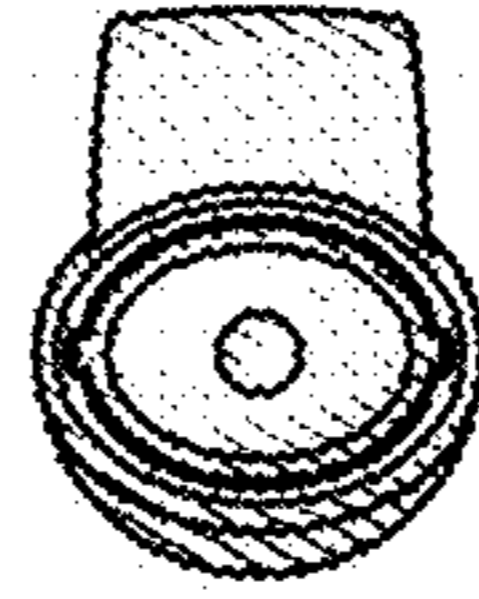
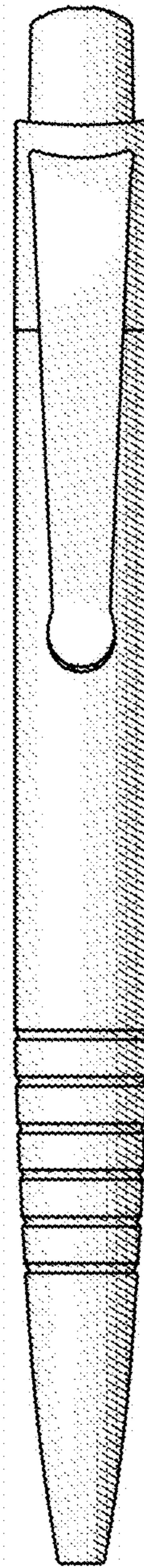

Fig.3



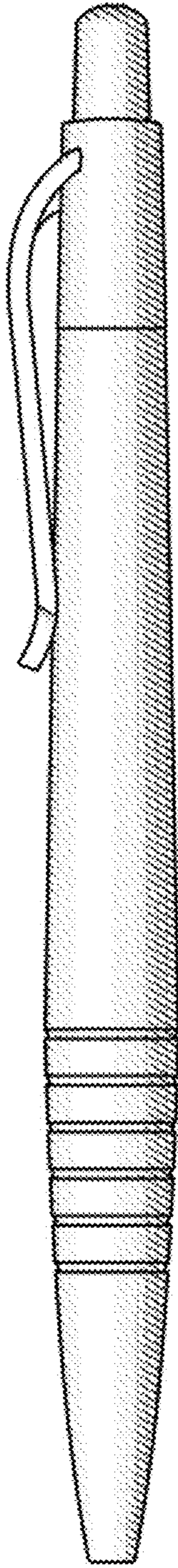

Fig.4

Fig.5



Fig.6

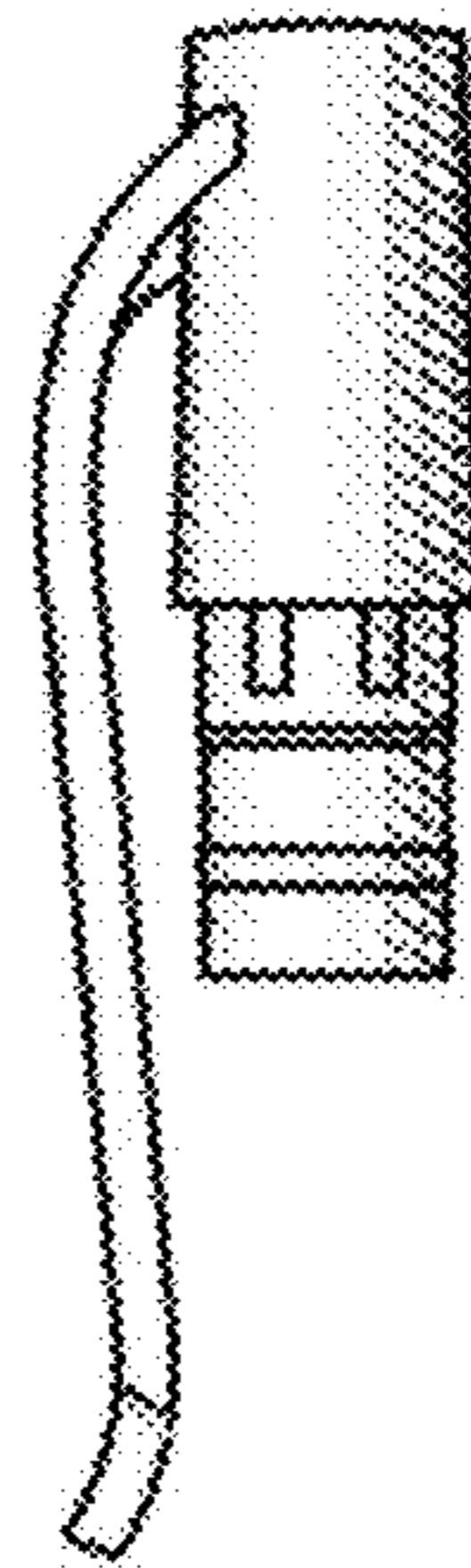

Fig.7

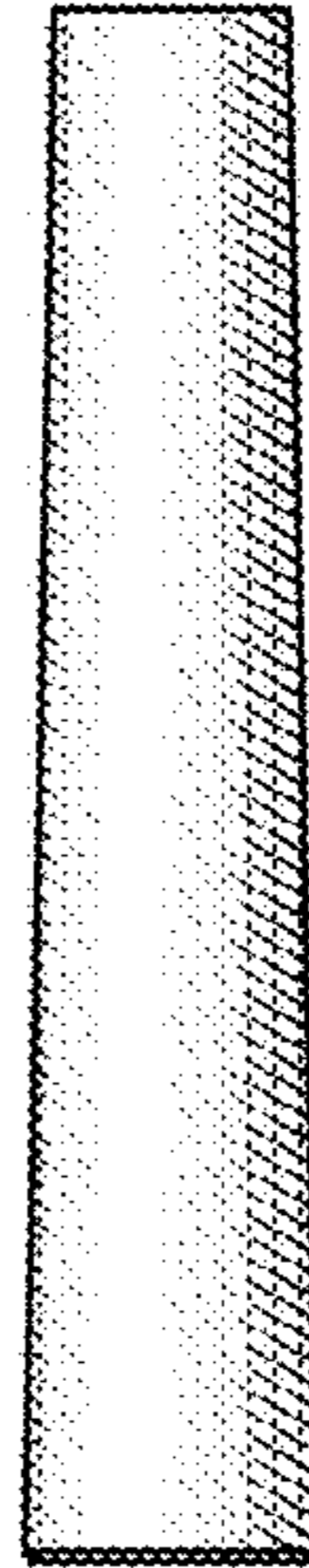

Fig.8

