



US00D740047S

(12) **United States Design Patent**
Rafieha

(10) **Patent No.:** **US D740,047 S**

(45) **Date of Patent:** **** Oct. 6, 2015**

(54) **SOFA**

(56) **References Cited**

(71) Applicant: **Abbyson Living Corporation,**
Calabasas, CA (US)

U.S. PATENT DOCUMENTS

(72) Inventor: **Doddy Rafieha,** Calabasas, CA (US)

D379,036	S	*	5/1997	Natuzzi et al.	D6/381
D380,622	S	*	7/1997	Chandler	D6/381
D388,261	S	*	12/1997	Natuzzi et al.	D6/381
D388,970	S	*	1/1998	Natuzzi et al.	D6/381
D419,794	S	*	2/2000	Natuzzi et al.	D6/381
D430,411	S	*	9/2000	Zaidman	D6/334
D448,198	S	*	9/2001	Natuzzi et al.	D6/381
D488,311	S	*	4/2004	Boydak	D6/335
D497,733	S	*	11/2004	Ricci	D6/381
D514,334	S	*	2/2006	Ricci	D6/334
D514,347	S	*	2/2006	Natuzzi	D6/381
D539,558	S	*	4/2007	Nastri	D6/381

(73) Assignee: **Abbyson Living Corporation,**
Calabasas, CA (US)

(**) Term: **14 Years**

(21) Appl. No.: **29/515,459**

* cited by examiner

(22) Filed: **Jan. 23, 2015**

(51) **LOC (10) Cl.** **06-01**

Primary Examiner — Sandra Snapp

(52) **U.S. Cl.**

(74) *Attorney, Agent, or Firm* — Charles E. Baxley

USPC **D6/381**

(57) **CLAIM**

(58) **Field of Classification Search**

The ornamental design for a sofa, as shown and described.

USPC 22/334–338, 349, 355, 361, 368–370,
22/376, 379–381, 716, 716.1, 716.2, 340,
22/354, 377, 709, 710, 716.4, 367;
297/16.1, 42, 94, 135, 175, 232, 233,
297/350, 351, 445.1, 448.1, 448.2, 451.9,
297/452.1, DIG. 7; 5/12.1, 12.2

CPC A47C 1/02; A47C 1/024; A47C 7/18;
A47C 7/24; A47C 17/00; A47C 17/02;
A47C 17/175

DESCRIPTION

FIG. 1 is a perspective view of a sofa according to this design;
FIG. 2 is a front view thereof;
FIG. 3 is a top plan view thereof;
FIG. 4 is a rear view thereof;
FIG. 5 is a bottom plan view thereof; and,
FIG. 6 is a right side view thereof, the left side being a mirror
image thereof.

See application file for complete search history.

1 Claim, 6 Drawing Sheets

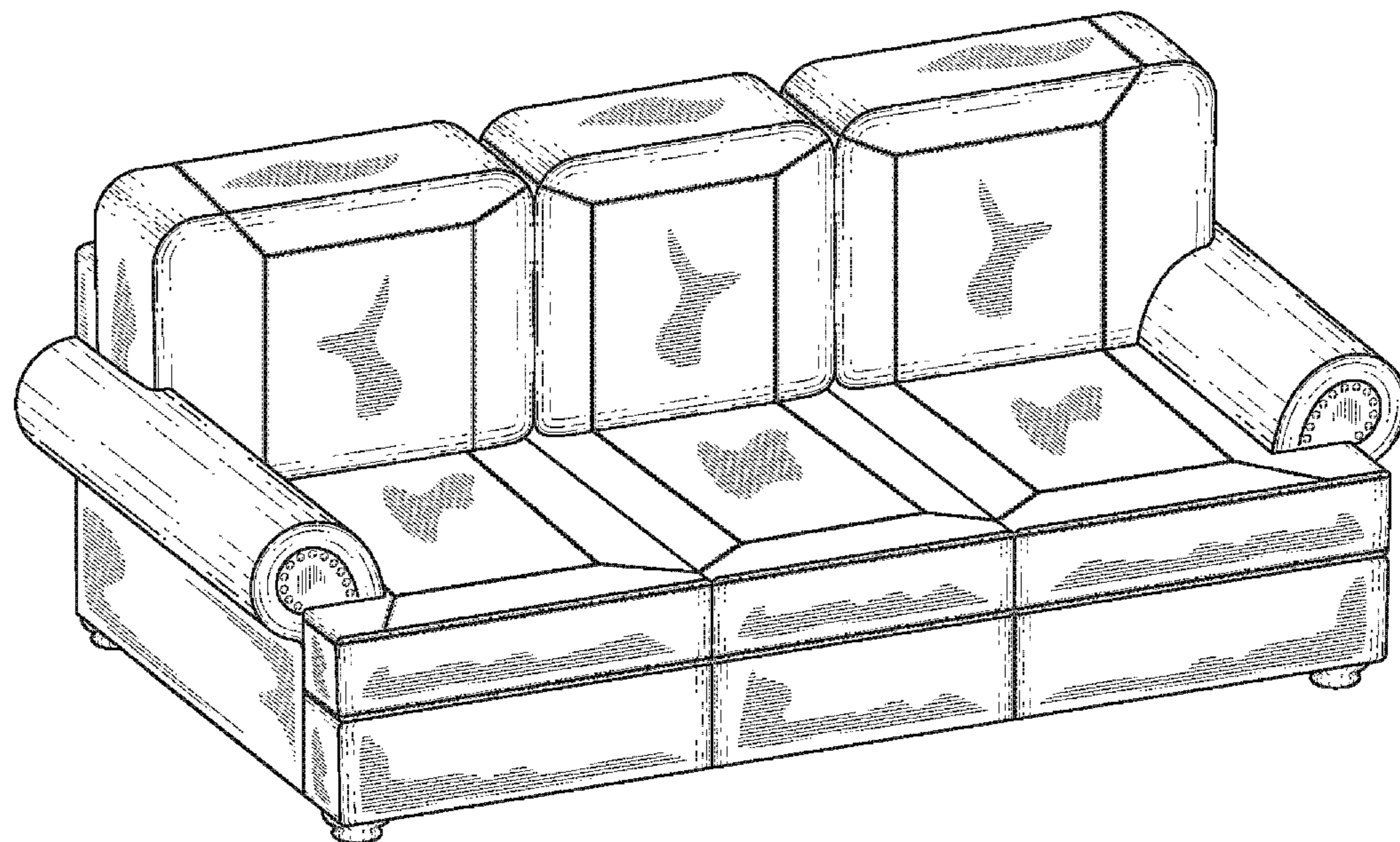

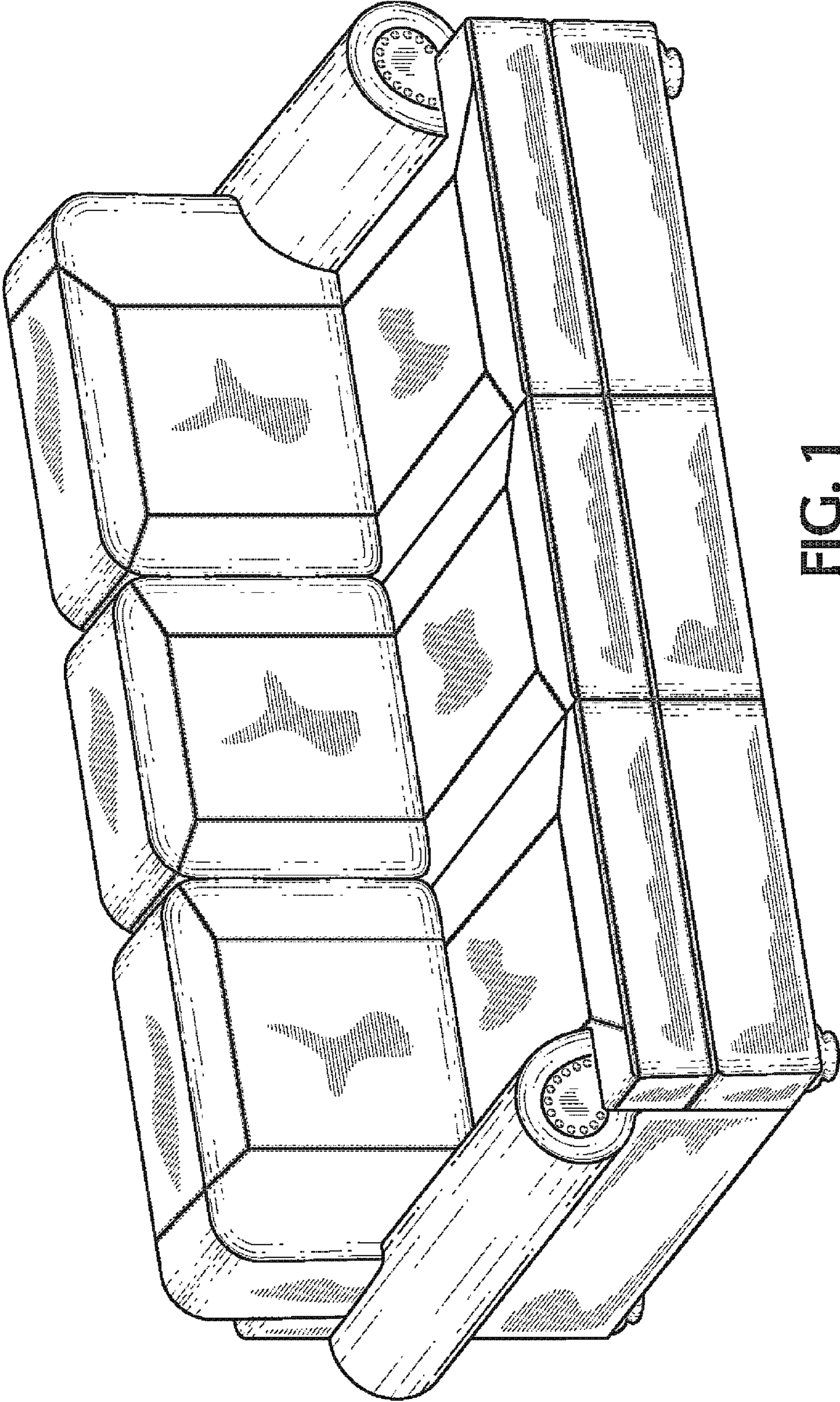

FIG. 1

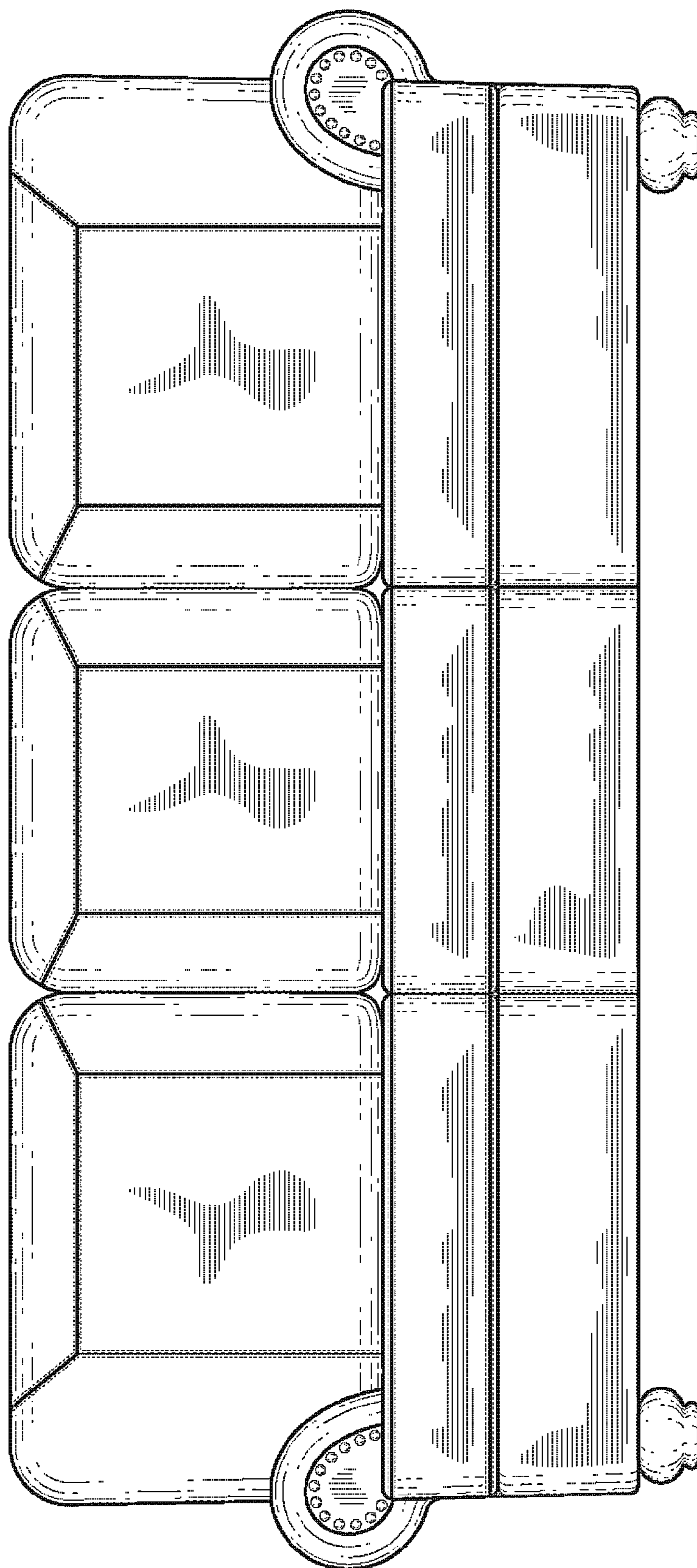

FIG. 2

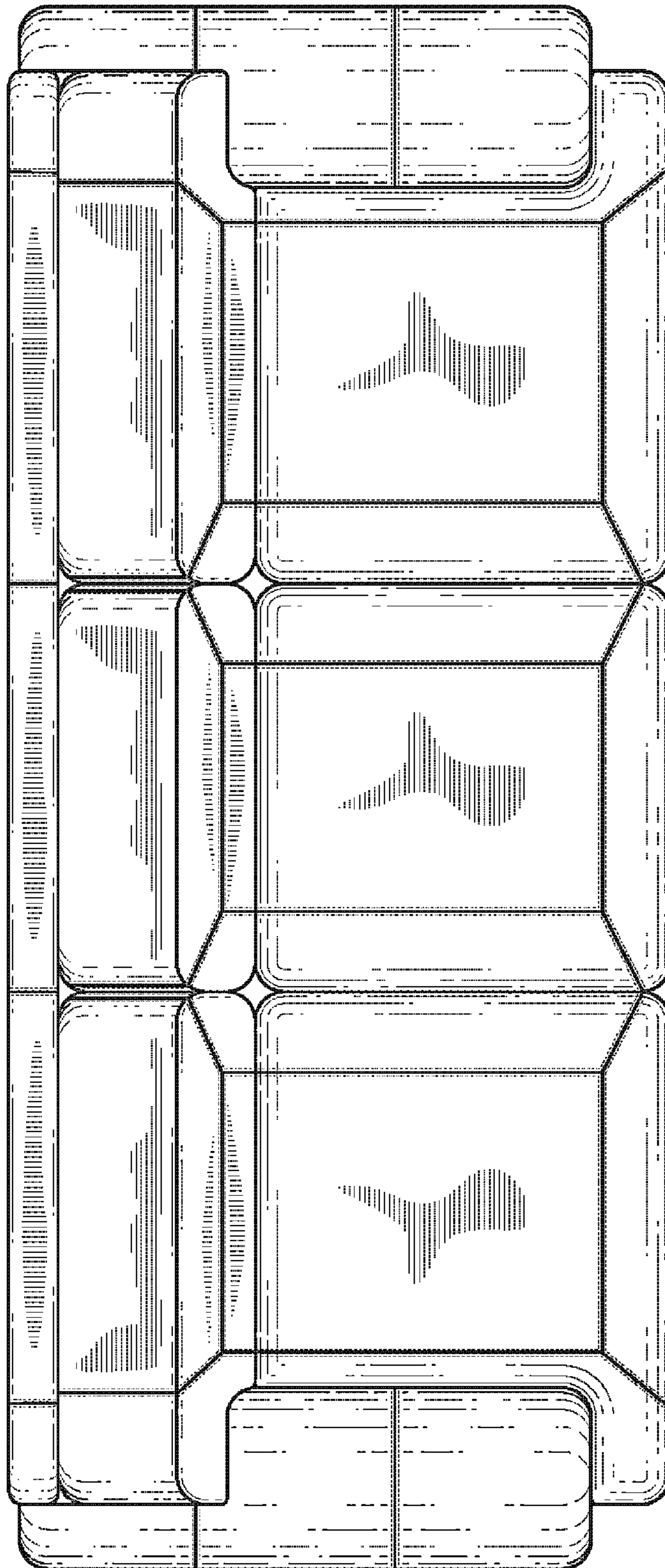

FIG. 3

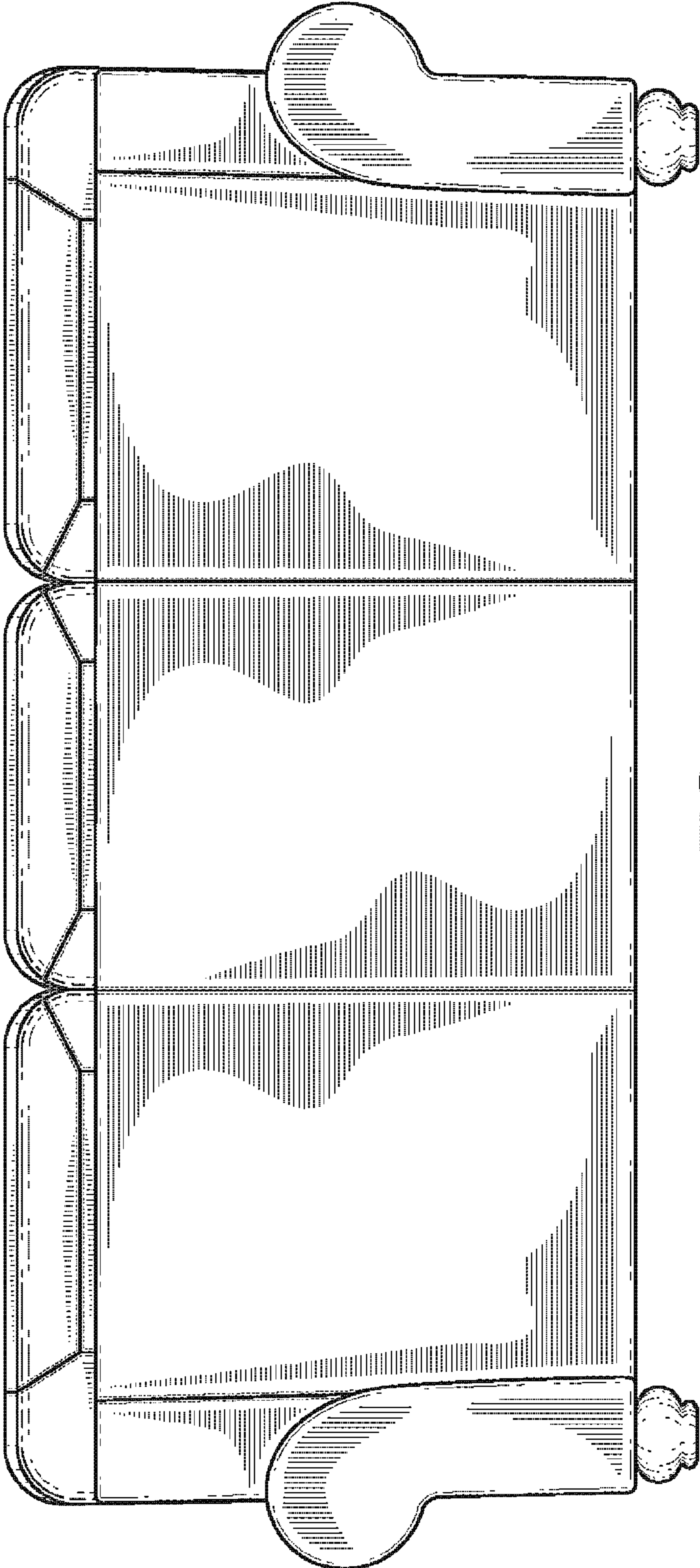

FIG. 4

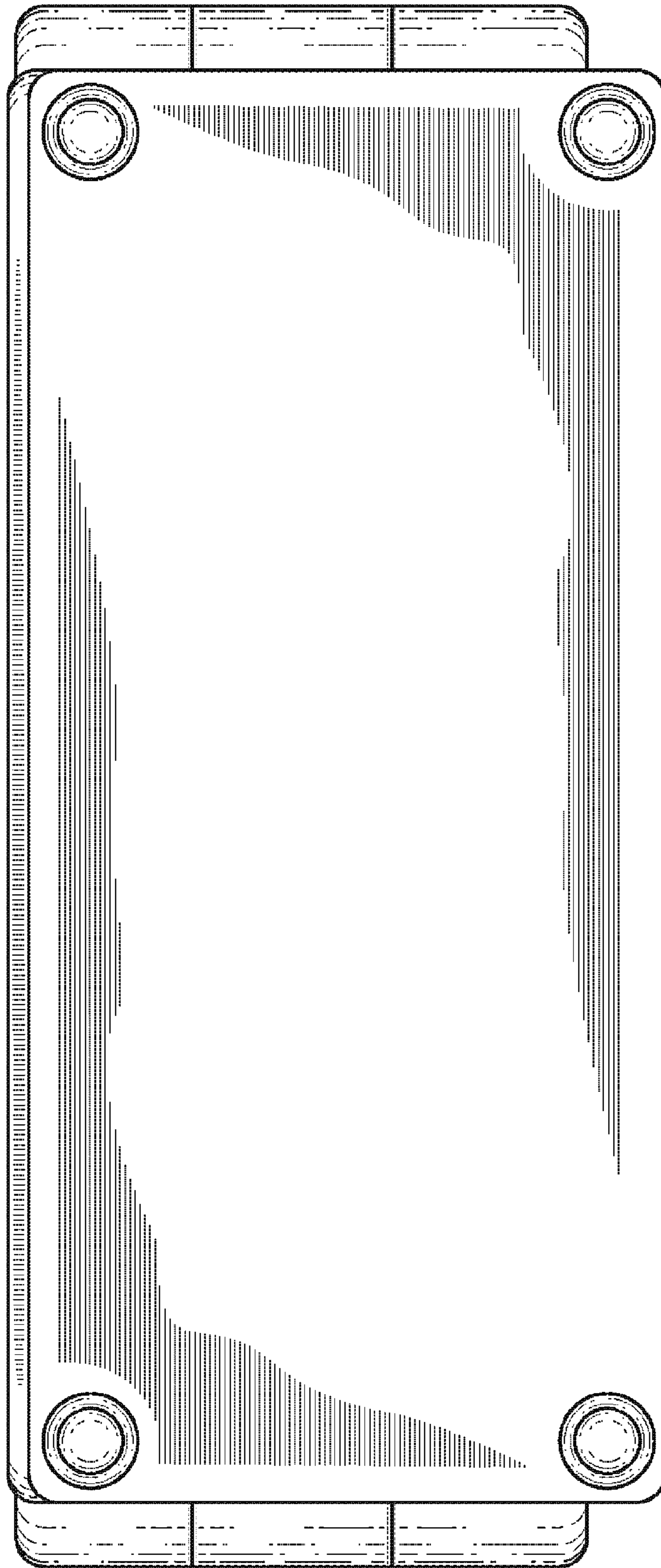

FIG. 5

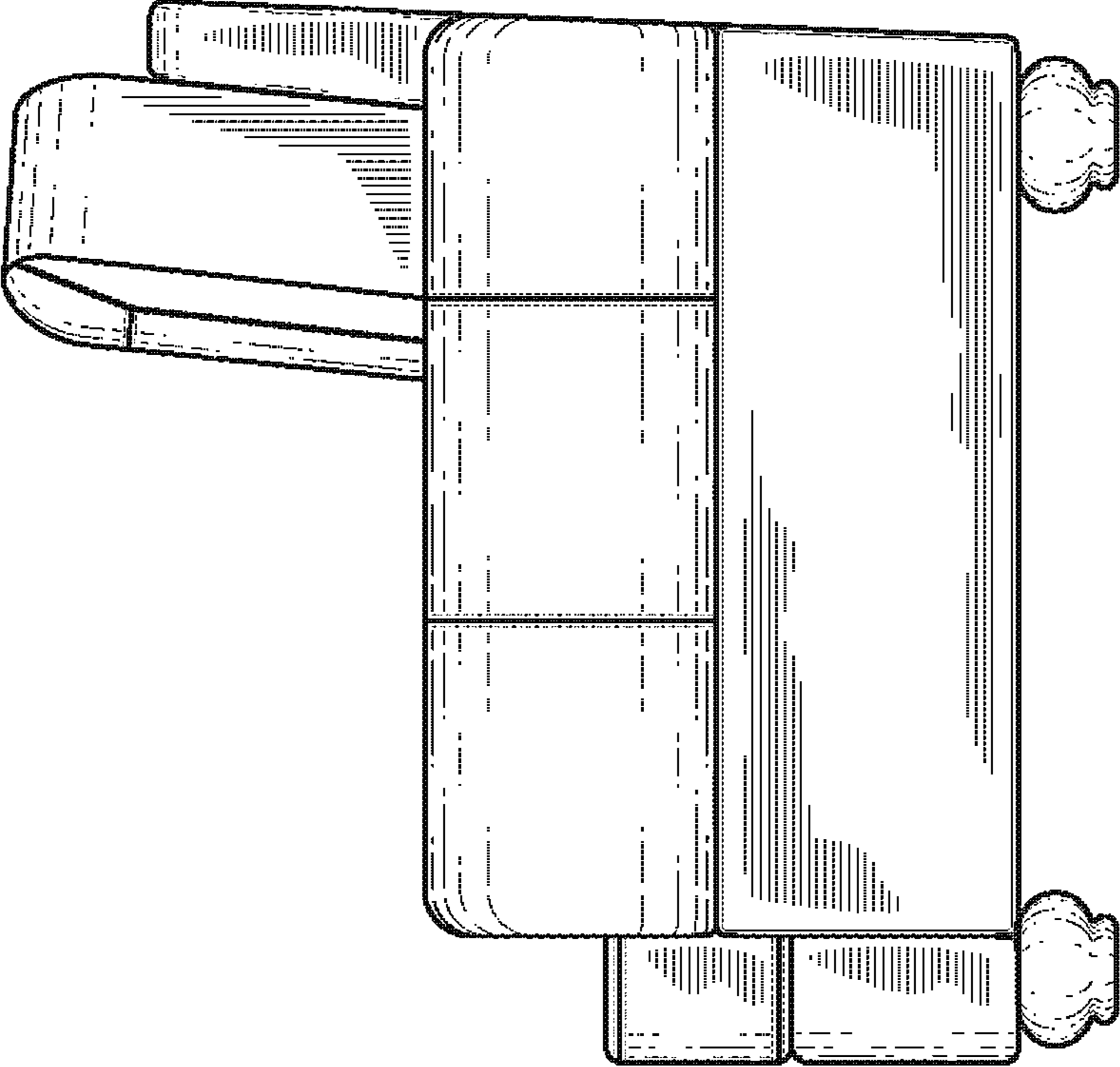

FIG. 6