

US00D740016S

(12) **United States Design Patent**
Roberto

(10) **Patent No.:** **US D740,016 S**
(45) **Date of Patent:** **** Oct. 6, 2015**

(54) **UPRIGHT ROD FOR A STANDING UMBRELLA**

(71) Applicant: **Claudio Roberto**, Kirchberg (CH)

(72) Inventor: **Claudio Roberto**, Kirchberg (CH)

(73) Assignee: **Glatz AG**, Frauenfeld (CH)

(**) Term: **14 Years**

(21) Appl. No.: **29/446,484**

(22) Filed: **Feb. 25, 2013**

(30) **Foreign Application Priority Data**

Feb. 11, 2013 (EM) 002181990

(51) **LOC (10) Cl.** **03-03**

(52) **U.S. Cl.**
USPC **D3/10**

(58) **Field of Classification Search**
USPC D3/5, 10, 11, 12; D6/524, 527, 712;
D16/136, 214, 242, 244, 250; D25/56,
D25/61, 69, 122, 126, 133; D26/43;
D8/382; D13/182; D23/266; 138/145;
135/16, 22, 24, 55, 254
CPC A45B 23/00; A45B 2023/0006; A45B
2023/0012; A45B 1/00
See application file for complete search history.

(56) **References Cited**

U.S. PATENT DOCUMENTS

169,699 A * 11/1875 Hazelton 138/145
D345,197 S * 3/1994 Potter D23/266
D408,621 S * 4/1999 Kuo D3/10
D447,251 S * 8/2001 Tsai D25/131

D473,663 S * 4/2003 Chou D25/122
D586,550 S * 2/2009 Hermanson et al. D3/10
D626,772 S * 11/2010 Chou D6/580
D661,265 S * 6/2012 Kajiya et al. D13/182
D714,132 S * 9/2014 Hazantonis D8/382
D715,082 S * 10/2014 Sugiura D6/712

FOREIGN PATENT DOCUMENTS

EM 000680434-0002 * 4/2007

* cited by examiner

Primary Examiner — Thomas Johannes

Assistant Examiner — Catherine Posthauer

(74) *Attorney, Agent, or Firm* — George Pappas

(57) **CLAIM**

I claim the ornamental design for an upright rod for a standing umbrella, as shown and described.

DESCRIPTION

FIG. 1 is a side elevation view of an upright rod for a standing umbrella showing my new design;
FIG. 2 is an enlarged perspective view of the break portion of FIG. 1;
FIG. 3 is a front elevation view of the break portion of FIG. 1;
FIG. 4 is a rear elevation view thereof;
FIG. 5 is a right side elevation view thereof;
FIG. 6 is a left side elevation view thereof;
FIG. 7 is a top plan view of FIG. 2; and,
FIG. 8 is a bottom plan view of FIG. 2.

The broken lines showing the umbrella base, cover, runner and ribs are shown to indicate portions of the umbrella and form no part of the claimed design. FIGS. 1-6 are shown with a symbolic break in the length. The appearance of any portion of the article between the break lines forms no part of the claimed design.

1 Claim, 7 Drawing Sheets

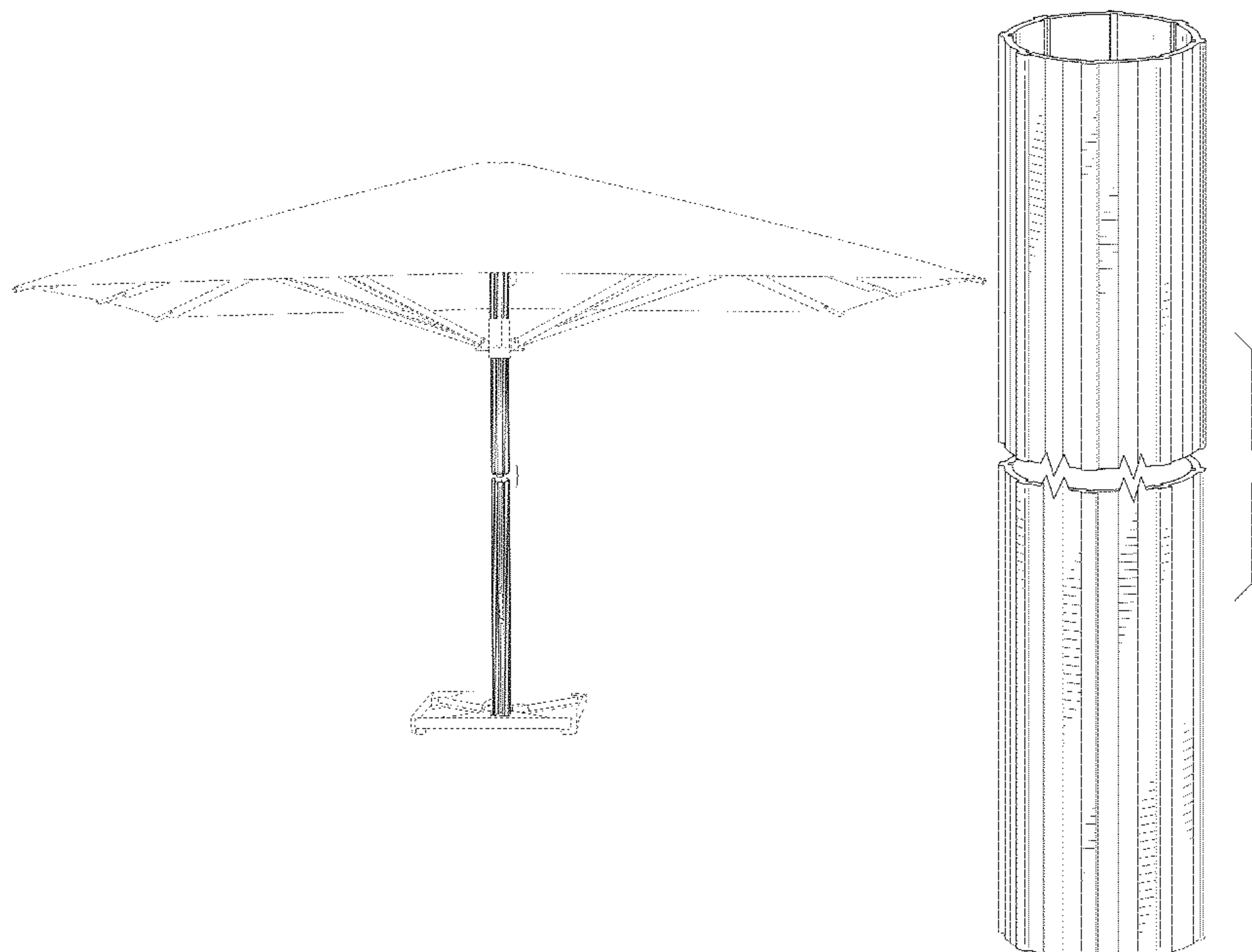

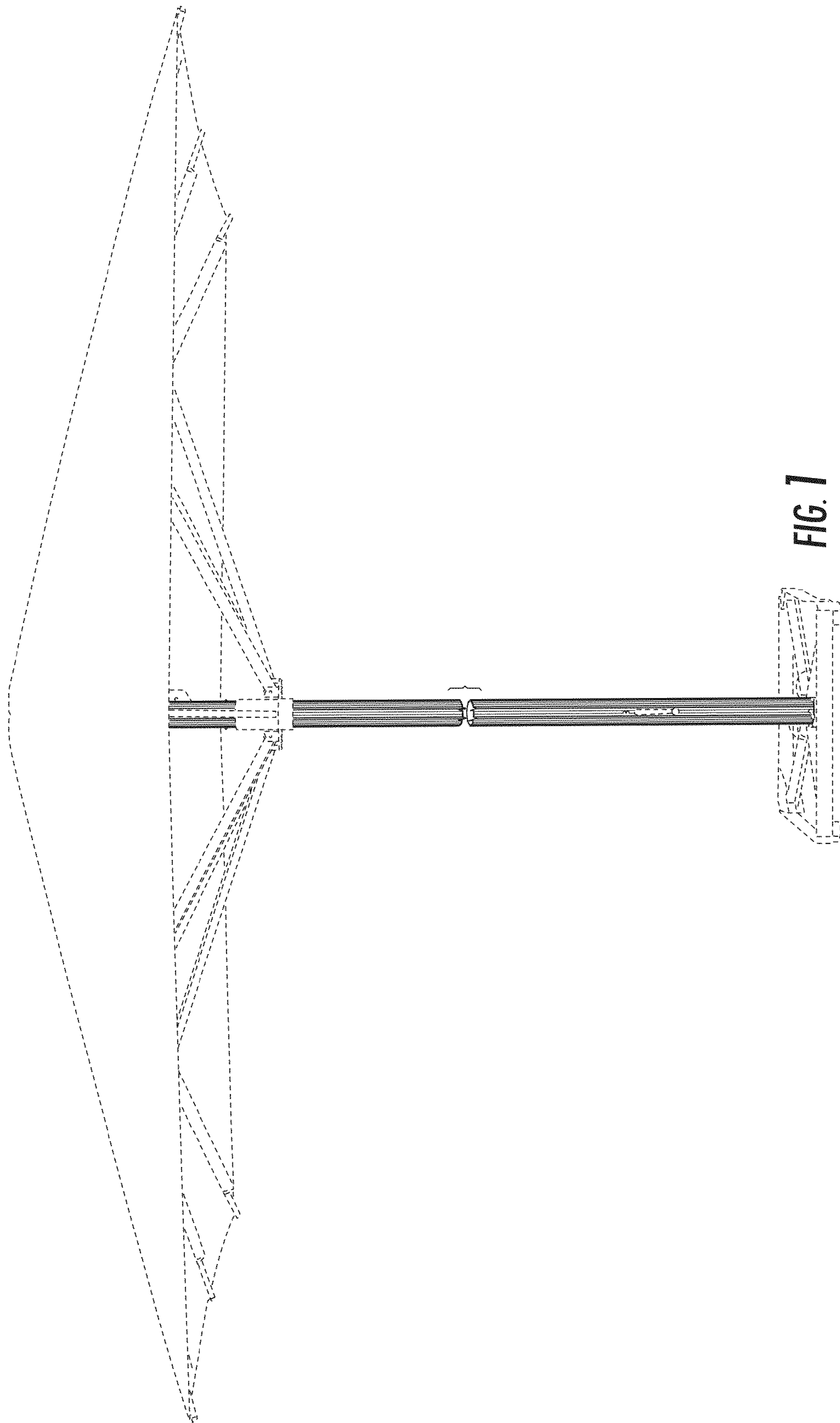

FIG. 1

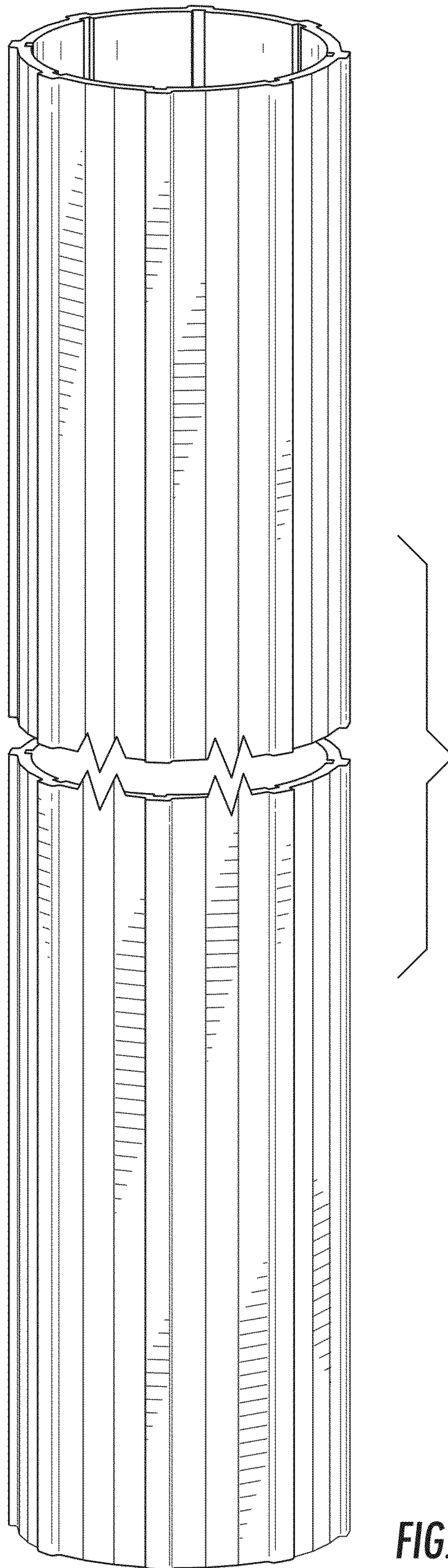

FIG. 2

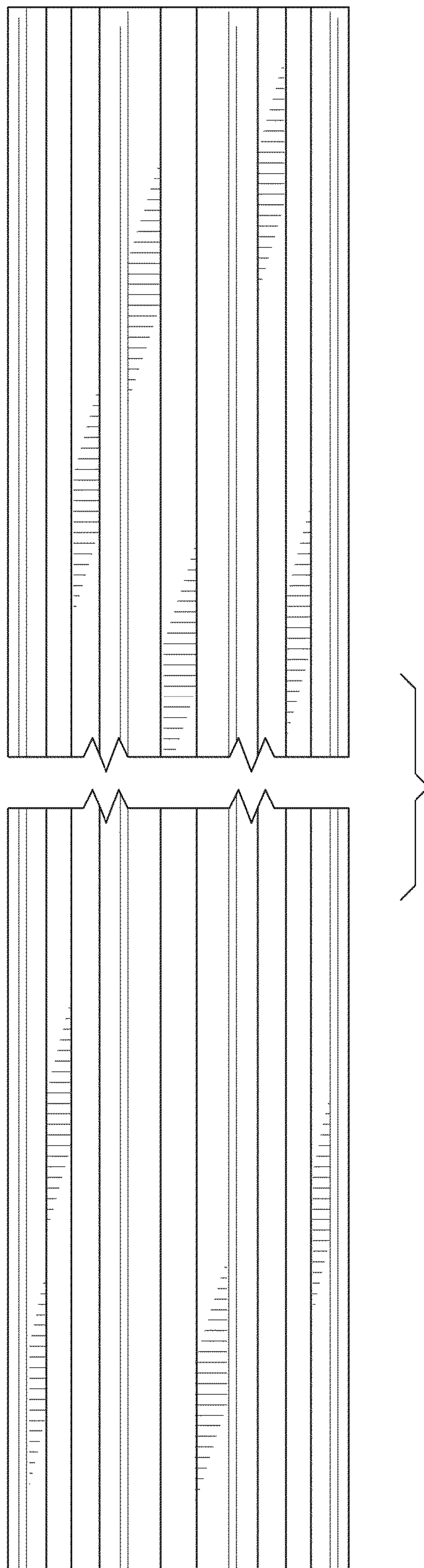

FIG. 3

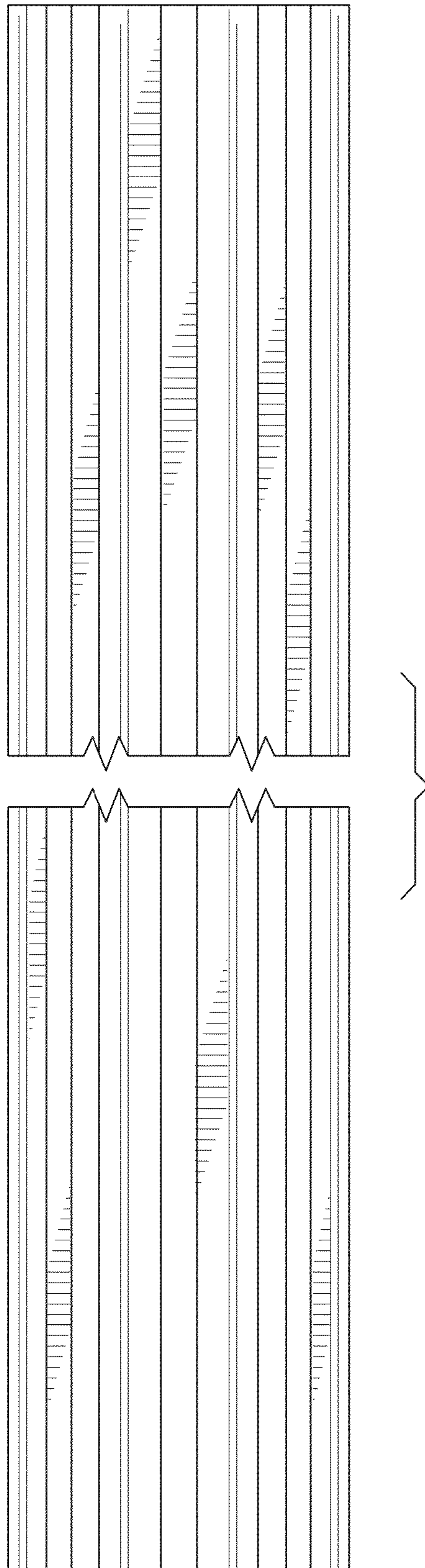

FIG. 4

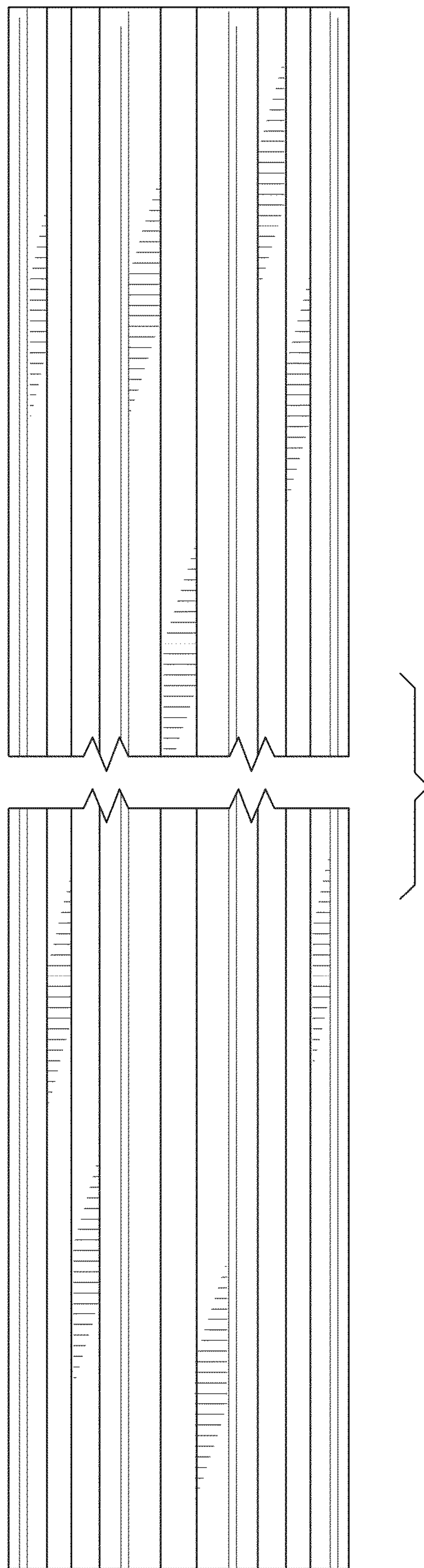

FIG. 5

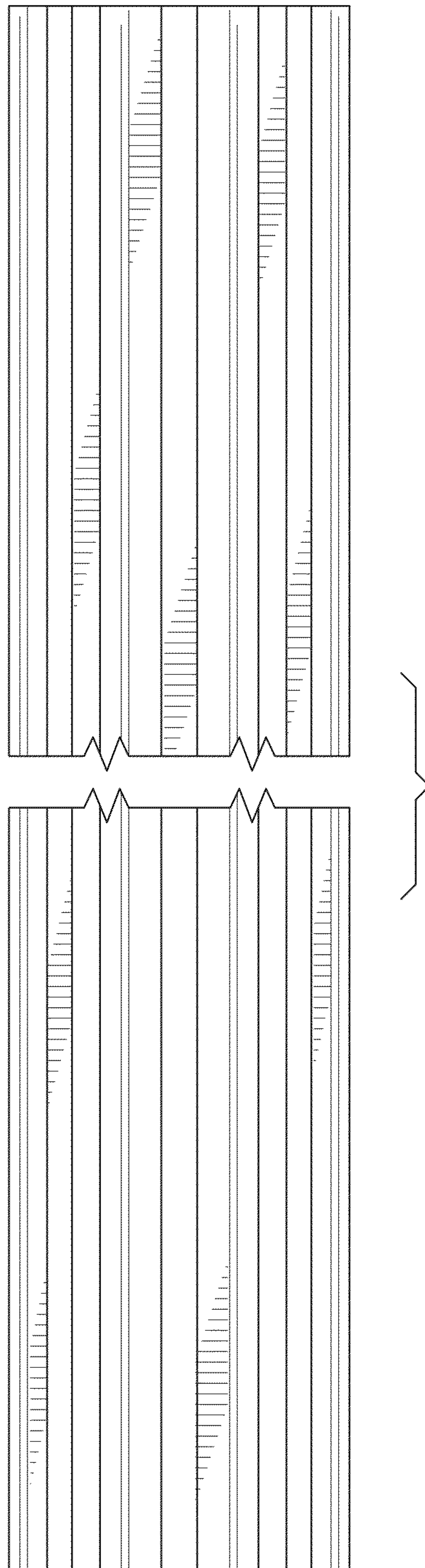

FIG. 6

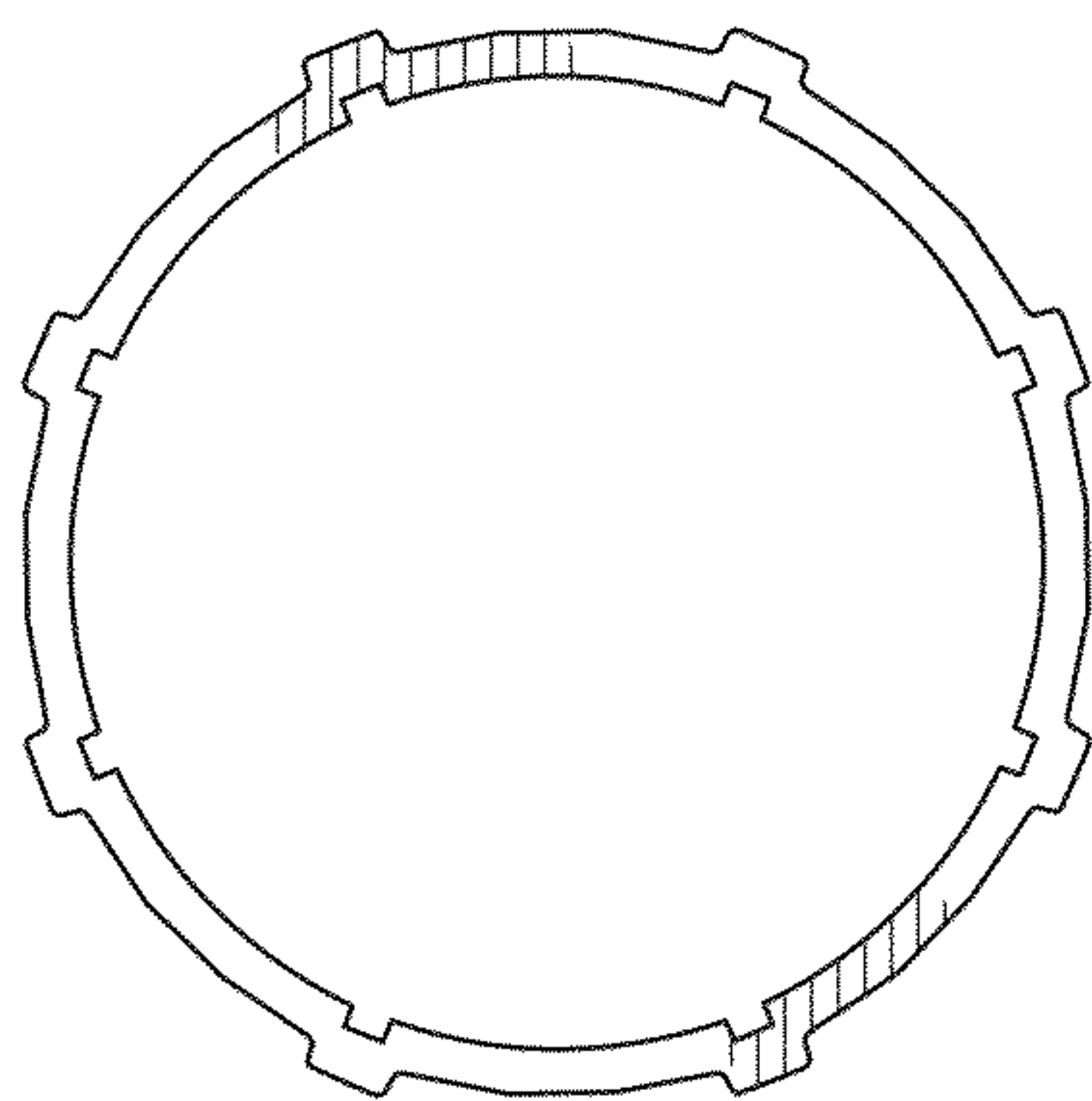

FIG. 7

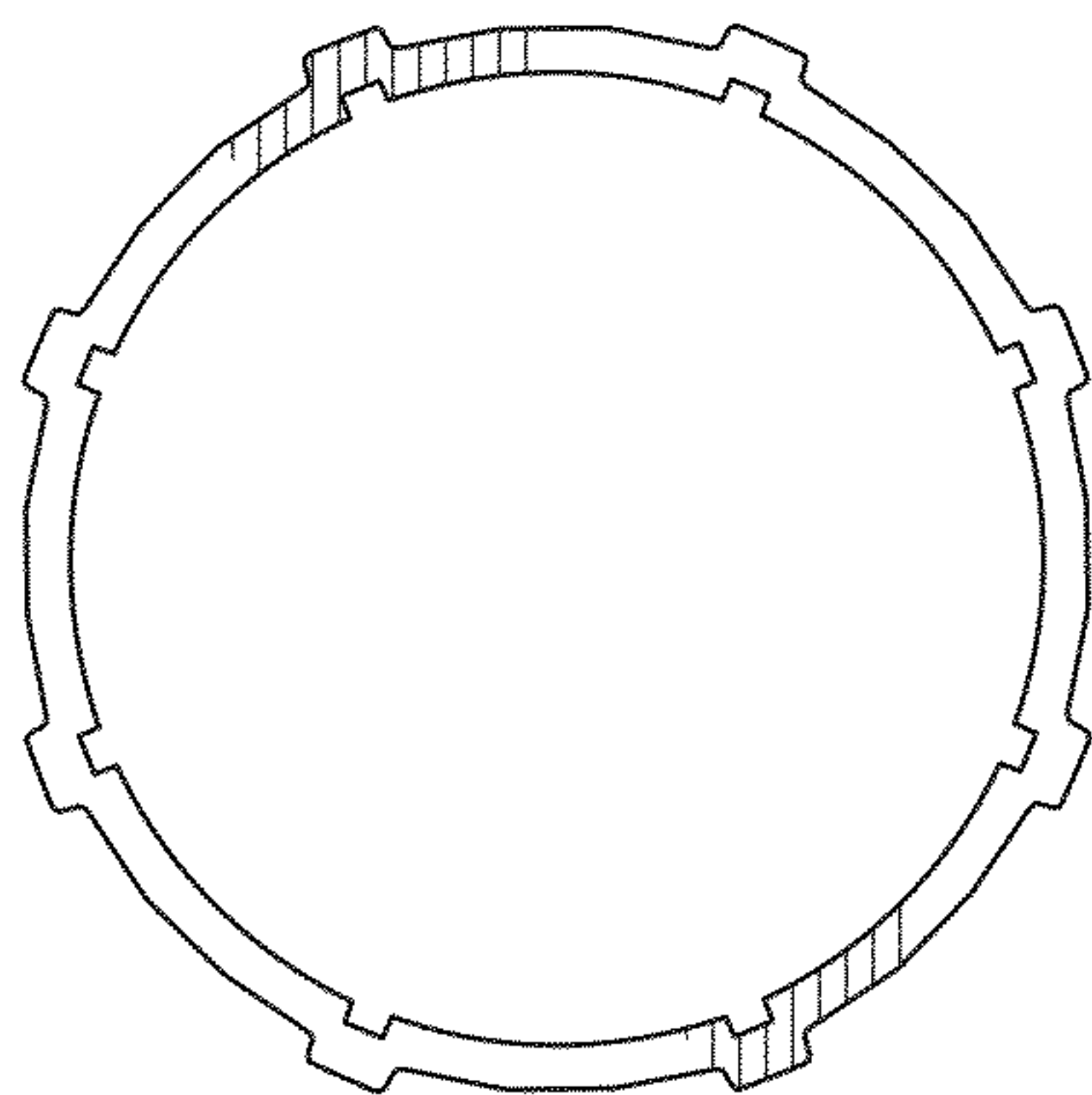

FIG. 8