



US00D740013S

(12) **United States Design Patent**
Kirschner

(10) **Patent No.:** **US D740,013 S**

(45) **Date of Patent:** **** Oct. 6, 2015**

(54) **SHOE UPPER**

(71) Applicant: **NIKE, Inc.**, Beaverton, OR (US)

(72) Inventor: **Patrick B. Kirschner**, Beaverton, OR (US)

(73) Assignee: **NIKE, Inc.**, Beaverton, OR (US)

(**) Term: **14 Years**

(21) Appl. No.: **29/517,261**

(22) Filed: **Feb. 11, 2015**

(51) **LOC (10) Cl.** **02-99**

(52) **U.S. Cl.**
USPC **D2/975**

(58) **Field of Classification Search**
USPC D2/902, 906-908, 944, 969, 971-975
CPC .. A43B 13/181; A43B 13/141; A43B 13/186;
A43B 13/188; A43B 23/00; A43B 23/02;
A43B 5/00

See application file for complete search history.

(56) **References Cited**

U.S. PATENT DOCUMENTS

D88,864 S *	1/1933	Elkin	D2/972
D231,282 S	4/1974	Dassler et al.		
D238,723 S *	2/1976	Dassler	D2/975
D266,968 S *	11/1982	Railton	D2/969
D282,021 S *	1/1986	Linn	D2/969
D302,486 S *	8/1989	Brown et al.	D2/969
D341,476 S *	11/1993	Duclos	D2/969
D348,352 S	7/1994	Johnson		
D348,976 S *	7/1994	Van Noy	D2/969
D372,114 S	7/1996	Turner et al.		
D393,359 S	4/1998	Doxey		
D394,742 S	6/1998	Gaudio		
D397,862 S *	9/1998	Aird et al.	D2/975
D402,456 S	12/1998	Greenberg		
D405,242 S *	2/1999	Gillespie	D2/900
D410,691 S *	6/1999	Boyer	D2/902
D420,783 S *	2/2000	Brady et al.	D2/902

D435,162 S *	12/2000	Wilson	D2/969
D438,696 S *	3/2001	Haas	D2/969
D441,520 S *	5/2001	Lane et al.	D2/969
D443,130 S *	6/2001	Matis	D2/969
D444,624 S *	7/2001	Wilson	D2/969
D452,366 S	12/2001	Wilson		
D458,442 S	6/2002	Matis		

(Continued)

OTHER PUBLICATIONS

2002 Fall Men's and Women's Footwear; 71; NIKE Footwear Catalog, 2002 Fall Men's and Women's Footwear, p. 71, published Nov. 2001, NIKE, Inc., USA.

(Continued)

Primary Examiner — Dominic Simone

(74) *Attorney, Agent, or Firm* — Banner & Witcoff, Ltd.

(57) **CLAIM**

The ornamental design for a shoe upper, as shown and described.

DESCRIPTION

FIG. 1 is a perspective view of a shoe upper showing my new design;

FIG. 2 is a front view thereof;

FIG. 3 is a rear view thereof;

FIG. 4 is a top view thereof; and,

FIG. 5 is an enlarged view of FIG. 4 showing the claimed area in isolation from the environment.

The broken lines immediately adjacent to the shaded area represent unclaimed boundaries of the design. The six unshaded regions, demarcated by broken lines within the claimed region form no part of the claimed design. The contrast in shading represents a contrast in appearance only and does not represent any particular color, material, texture or finish. The broken lines showing the remainder of the shoe are for environmental purposes only and form no part of the claimed design.

1 Claim, 4 Drawing Sheets

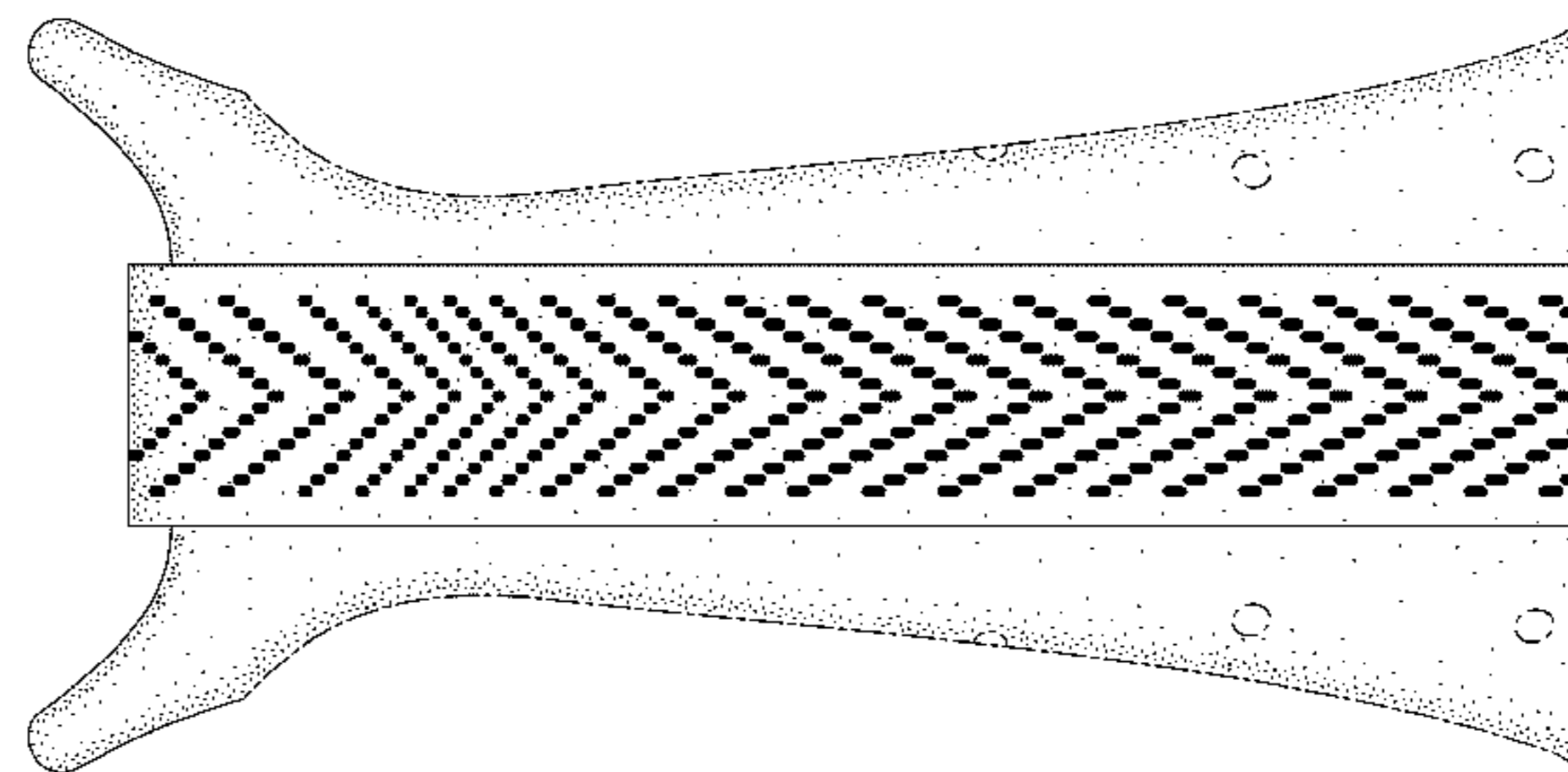
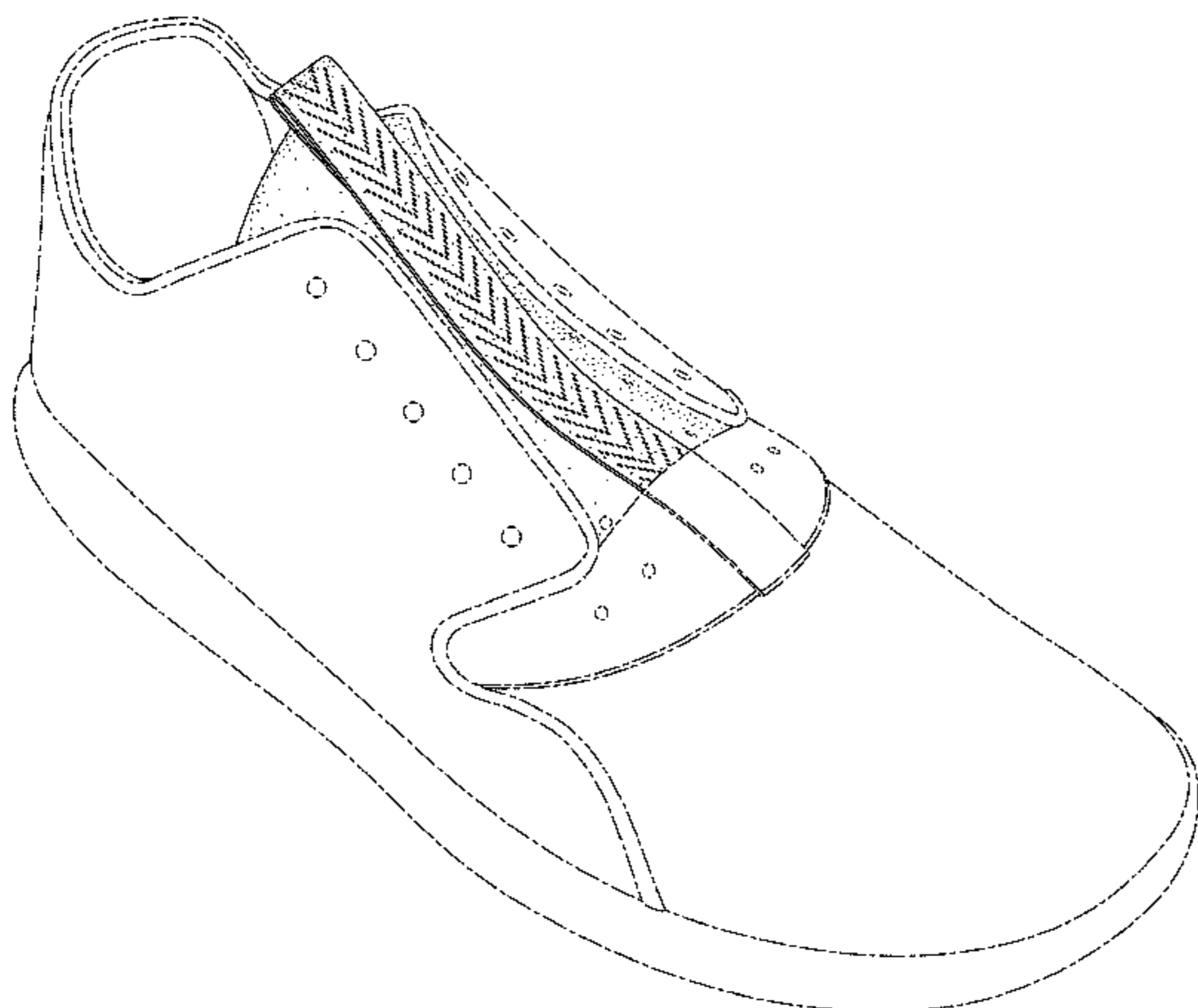

(56)

References Cited

U.S. PATENT DOCUMENTS

D466,683 S 12/2002 Chen
 D467,719 S * 12/2002 Blakeslee D2/972
 D468,521 S 1/2003 Wilson
 D470,302 S * 2/2003 Wilson D2/975
 D473,704 S * 4/2003 Wilson D2/972
 D479,388 S * 9/2003 Matis D2/969
 D480,540 S 10/2003 Hoyt et al.
 D481,530 S 11/2003 Hillyer
 D482,515 S 11/2003 St-Louis
 D482,858 S 12/2003 Hillyer
 D487,841 S 3/2004 Munns
 D499,875 S 12/2004 Lozano
 D503,268 S 3/2005 Belley et al.
 D513,361 S 1/2006 Teriatnikov
 D513,857 S 1/2006 Hlavacs
 D514,299 S 2/2006 Ardissono et al.
 D520,223 S * 5/2006 Burg D2/969
 D521,716 S 5/2006 Drazic
 D524,015 S 7/2006 Burg
 D533,986 S 12/2006 Belley et al.
 D541,029 S 4/2007 Matis et al.

D545,042 S 6/2007 McDowell
 D545,547 S 7/2007 Horne et al.
 D546,041 S 7/2007 Horne et al.
 D546,043 S 7/2007 Belley et al.
 D546,046 S * 7/2007 Schoenborn et al. D2/969
 D546,542 S 7/2007 Lubrano
 D549,441 S 8/2007 Chang
 D570,086 S 6/2008 McDowell
 D570,087 S 6/2008 Caine
 D579,186 S 10/2008 Mervar et al.
 D639,544 S 6/2011 Van Zyll De Jong et al.

OTHER PUBLICATIONS

2005 Spring Men's, Women's, Boy's, and Girl's Footwear; 39; Nike Footwear Catalog, 2005 Spring Men's, Women's, Boy's, and Girl's Footwear, p. 39, published Jun. 2004, NIKE, Inc., USA.
 2005 Spring Men's, Women's, Boy's, and Girl's Footwear; 49; Nike Footwear Catalog, 2005 Spring Men's, Women's, Boy's, and Girl's Footwear, p. 49, published Jun. 2004, NIKE, Inc., USA.
 2006 Fall Footwear; 190; Nike Footwear Catalog, 2006 Fall Footwear, p. 190, published Nov. 2005, NIKE, Inc., USA.

* cited by examiner

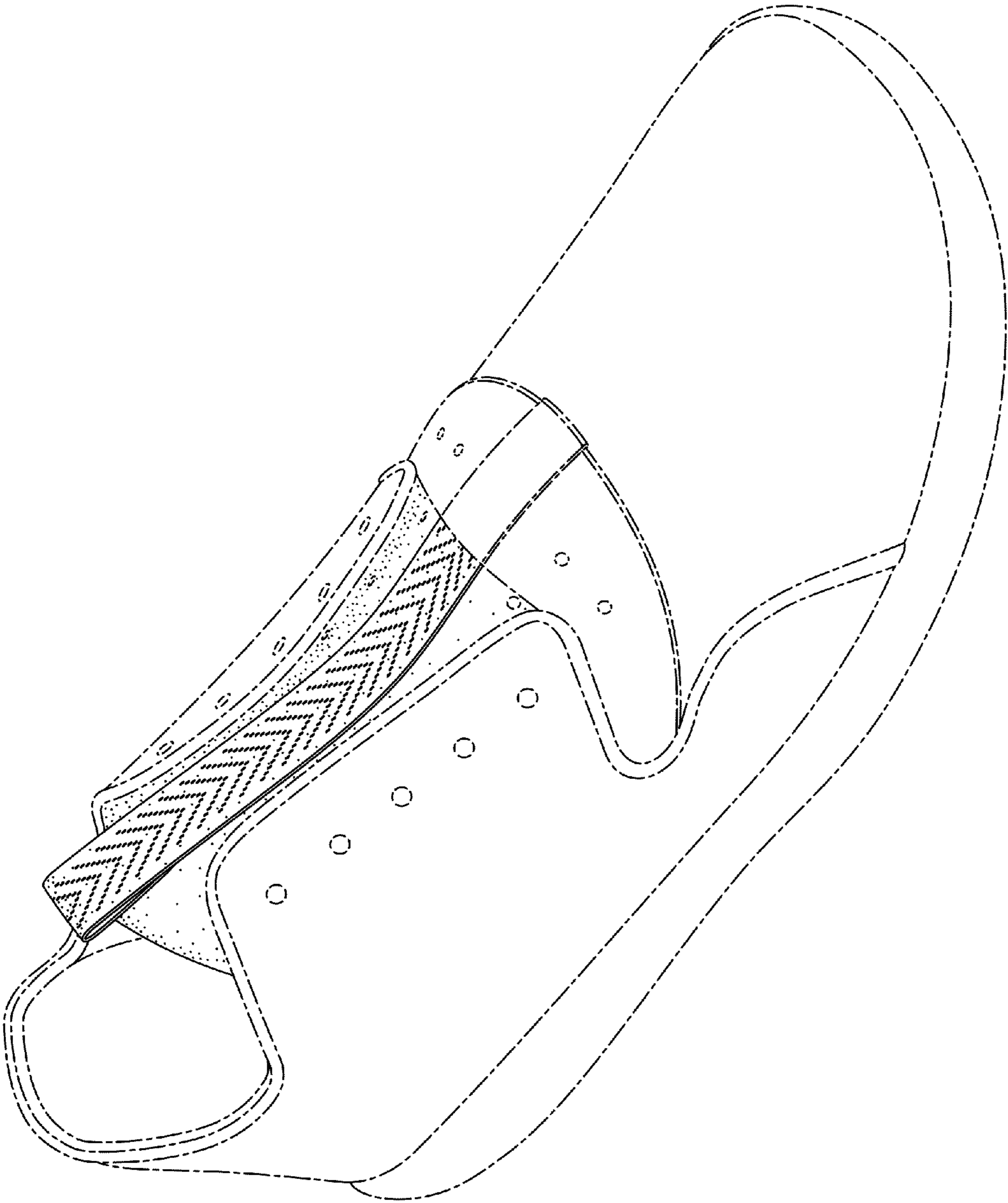

FIG. 1

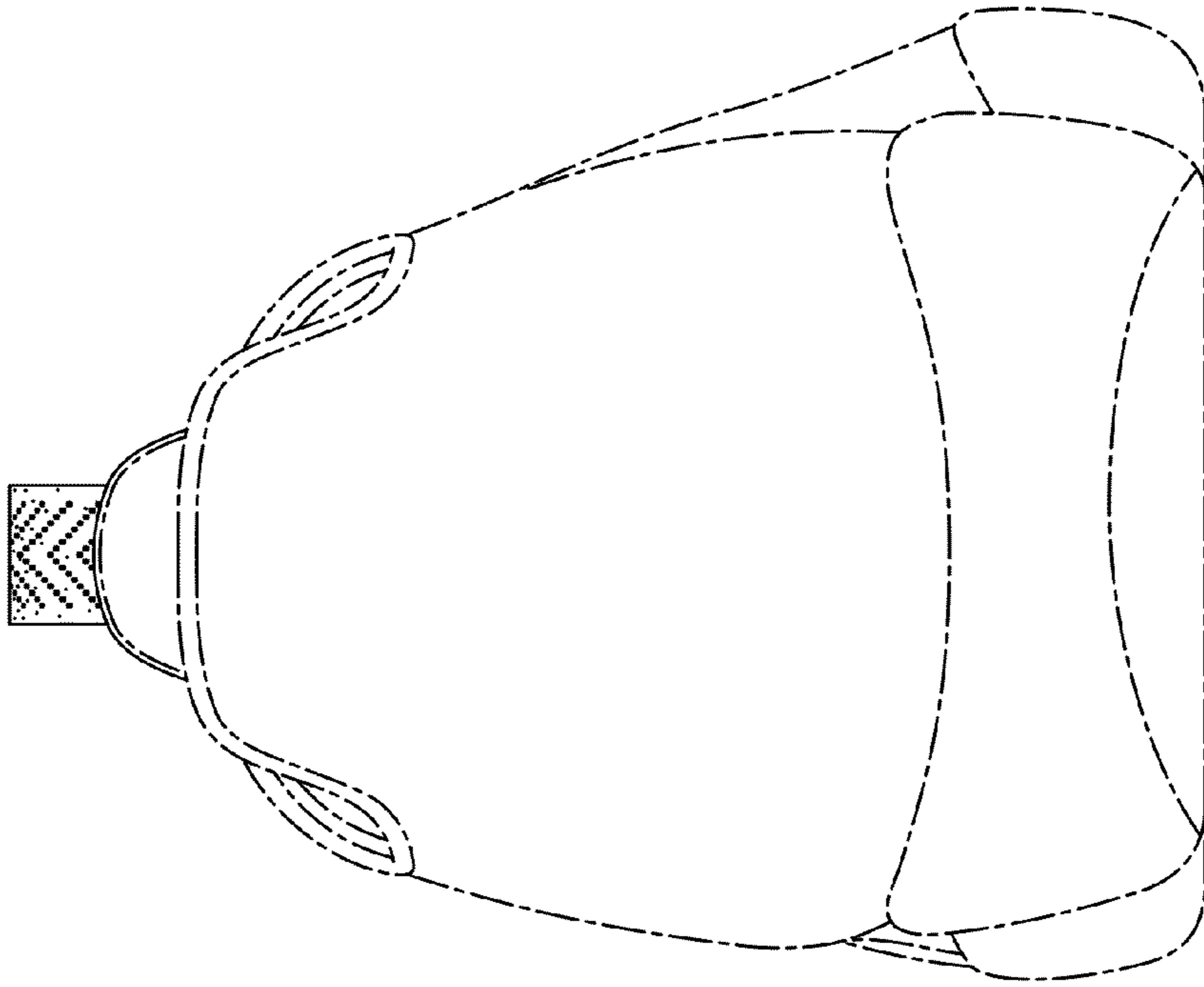

FIG. 3

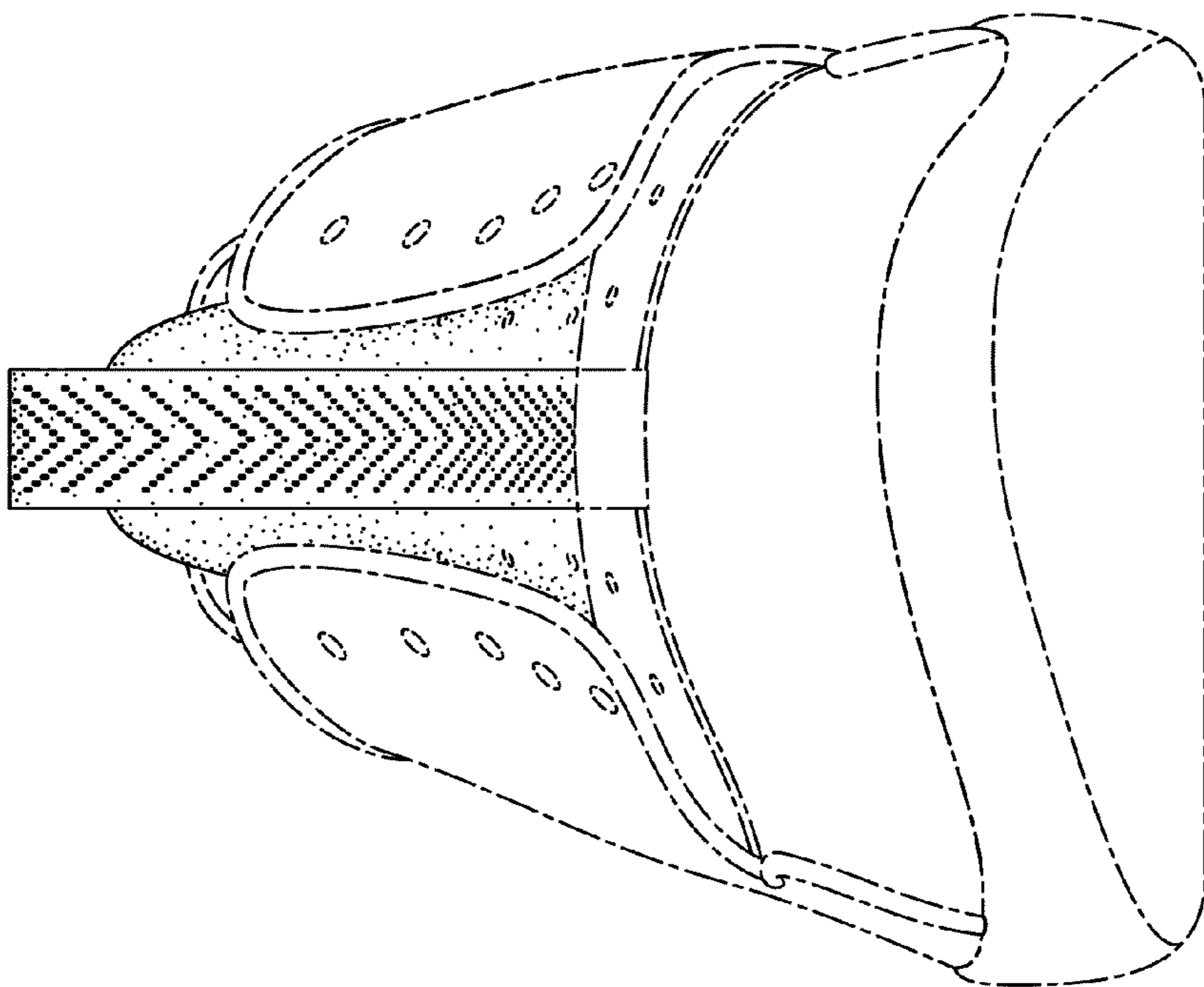

FIG. 2

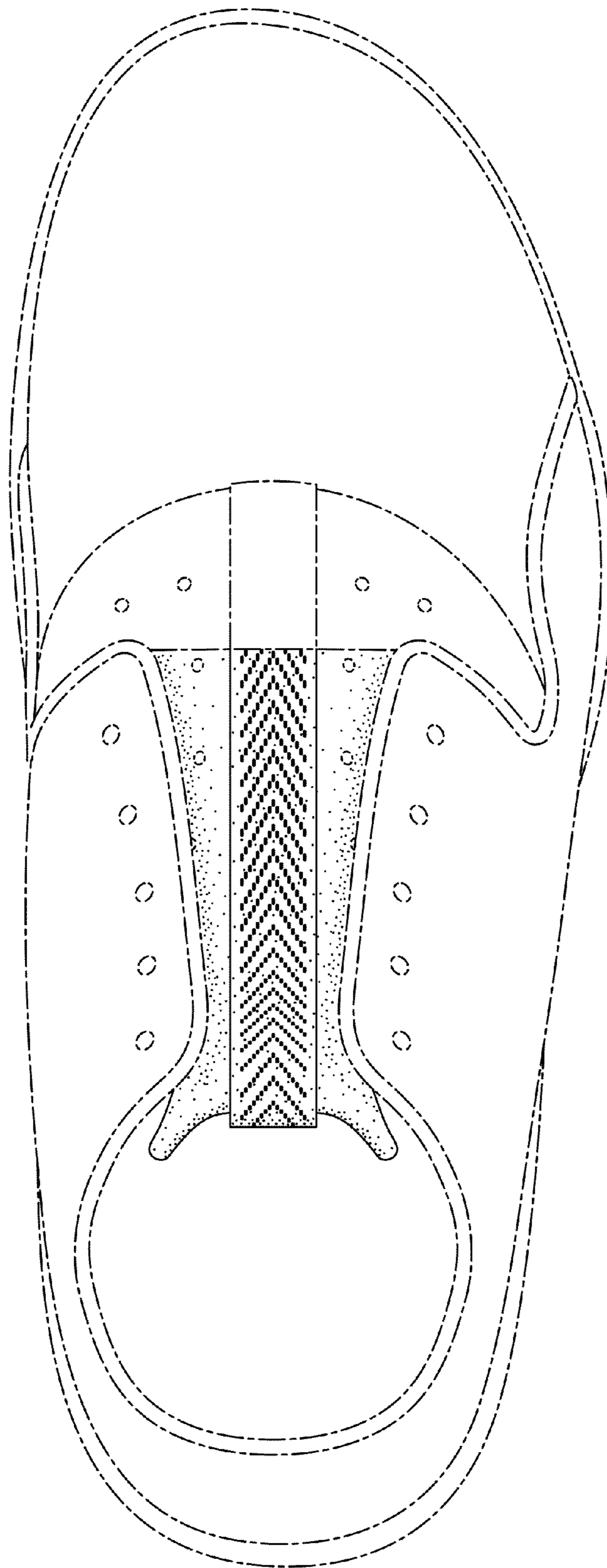

FIG. 4

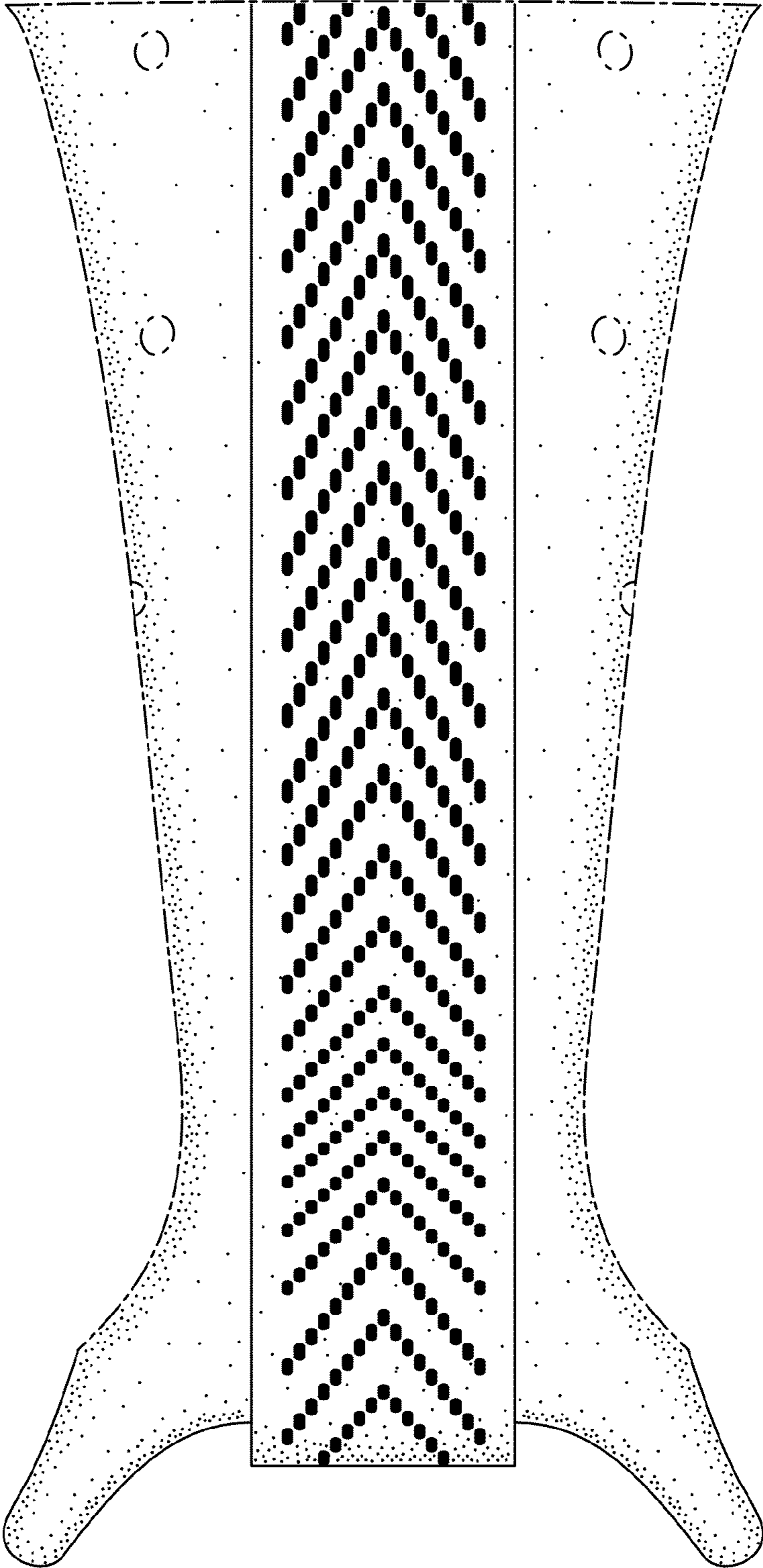

FIG. 5