



US00D739992S

(12) **United States Design Patent**
Fischer et al.

(10) **Patent No.:** **US D739,992 S**
(45) **Date of Patent:** **** Oct. 6, 2015**

(54) **DRINKING GLOVE**

(71) Applicants: **Lee MacKenzie Fischer**, Vesko (DK);
Michael Stenbæk Schmidt,
Copenhagen (DK)

(72) Inventors: **Lee MacKenzie Fischer**, Vesko (DK);
Michael Stenbæk Schmidt,
Copenhagen (DK)

(**) Term: **14 Years**

(21) Appl. No.: **29/470,265**

(22) Filed: **Oct. 18, 2013**

(30) **Foreign Application Priority Data**

Aug. 23, 2013 (EM) 002295949-0001

(51) **LOC (10) Cl.** **02-06**

(52) **U.S. Cl.**
USPC **D2/610; D29/113; D29/120.1**

(58) **Field of Classification Search**
USPC D2/610, 614, 618, 619, 620, 621, 623;
D29/114, 117.1, 120.1, 123; 2/159,
2/160, 161.5, 162, 163, 170, 910;
473/62, 61
CPC A41D 13/088; A41D 13/08; A41D 19/00;
A41D 19/0034; A41D 19/0044; A41F 1/06;
A63B 69/0046; A63B 71/146; A63B 71/14;
A63D 5/00

See application file for complete search history.

(56) **References Cited**

U.S. PATENT DOCUMENTS

1,728,679	A *	9/1929	Hansard	473/213
1,851,011	A *	3/1932	Jensen	2/16
2,740,968	A *	4/1956	Gardocki	2/161.5
4,332,382	A *	6/1982	Smith	473/62
4,371,163	A *	2/1983	Shaffer et al.	473/61
4,677,971	A *	7/1987	Lindemann	602/21
5,172,910	A *	12/1992	Ashurst	473/61
7,264,553	B1 *	9/2007	Addington et al.	473/61
2009/0318248	A1 *	12/2009	Russotti	473/450

* cited by examiner

Primary Examiner — Karen E. Eldridge Powers

Assistant Examiner — Jasmine Mlinarcik

(74) *Attorney, Agent, or Firm* — Benjamin M. Hanrahan;
Hanrahan Law Firm, P.A.

(57) **CLAIM**

The ornamental design for a drinking glove, as shown and described.

DESCRIPTION

FIG. 1 is a top plan view illustrating our design for a drinking glove.

FIG. 2 is a right side elevation view thereof.

FIG. 3 is a bottom plan view thereof.

FIG. 4 is a left side elevation view thereof.

FIG. 5 is a front elevation view thereof.

FIG. 6 is a rear elevation view thereof; and,

FIG. 7 is a top right perspective view thereof.

The dash-dot broken lines in FIGS. 1 and 3 representing a hand and part of an arm illustrate the environment in which the design is used and assists in showing how the claimed design appears when worn; the dash-dot broken lines form no part of the claimed design. The broken lines on the glove itself in FIGS. 1 through 7 represent stitching, and are part of the claimed design.

1 Claim, 7 Drawing Sheets

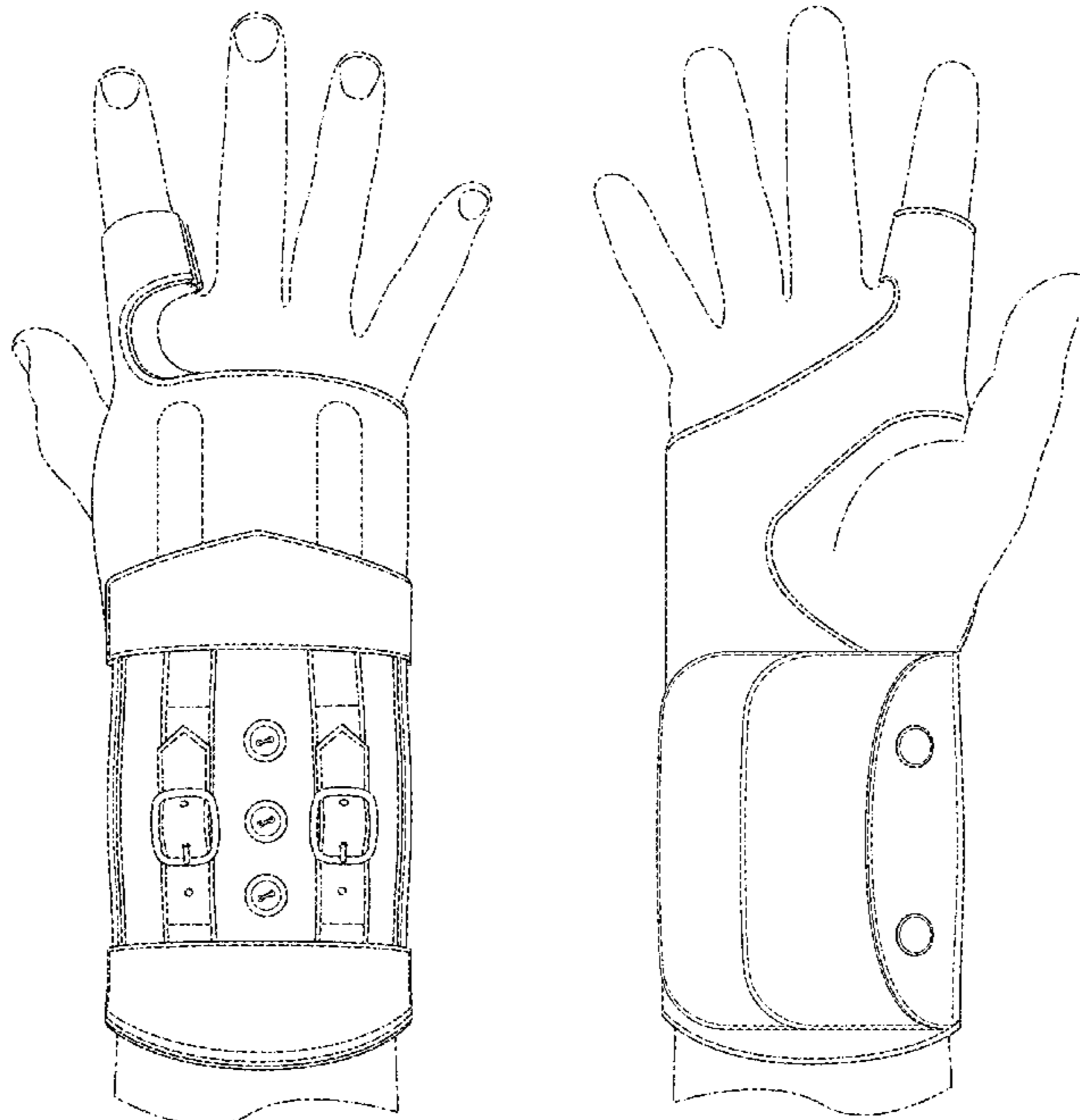

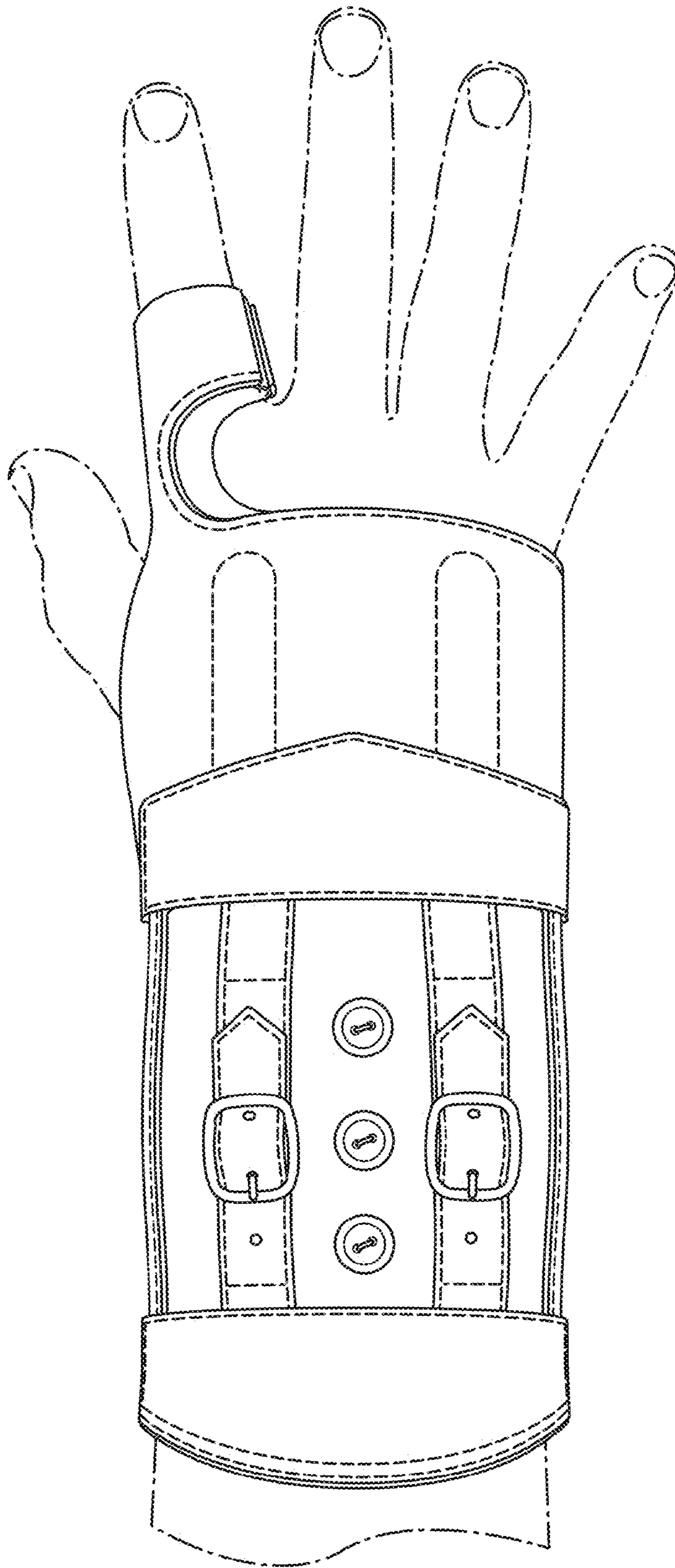

FIG. 1

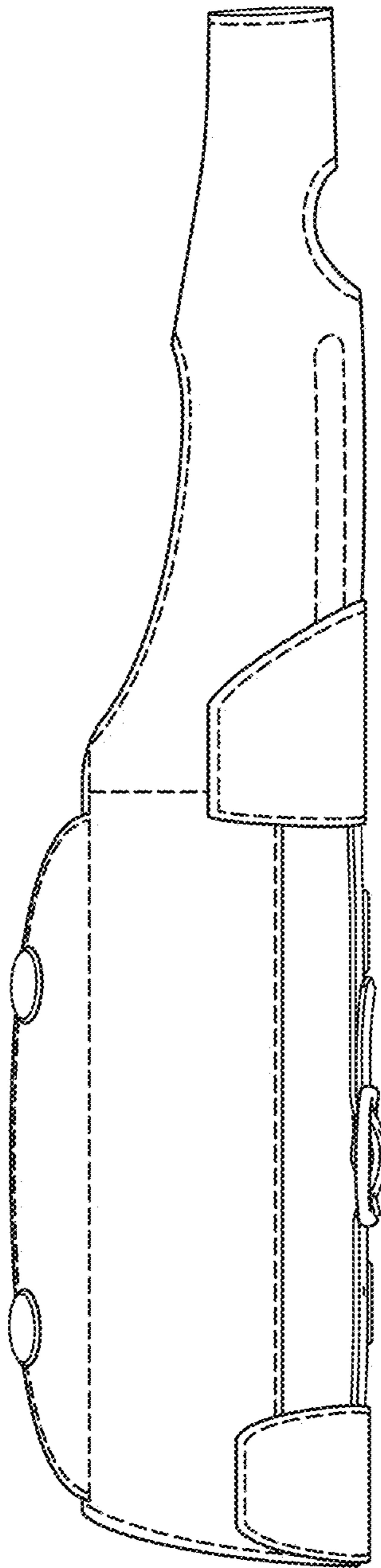

FIG. 2

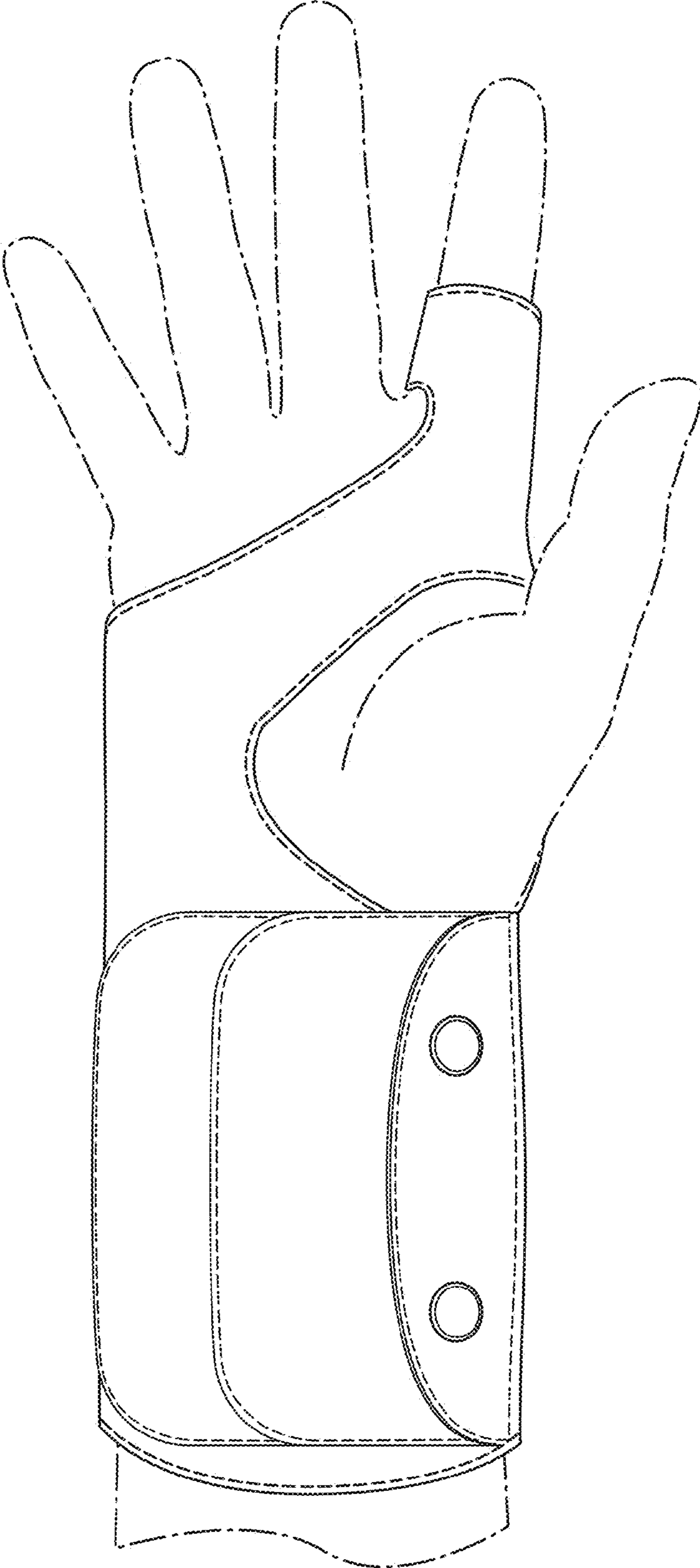

FIG. 3

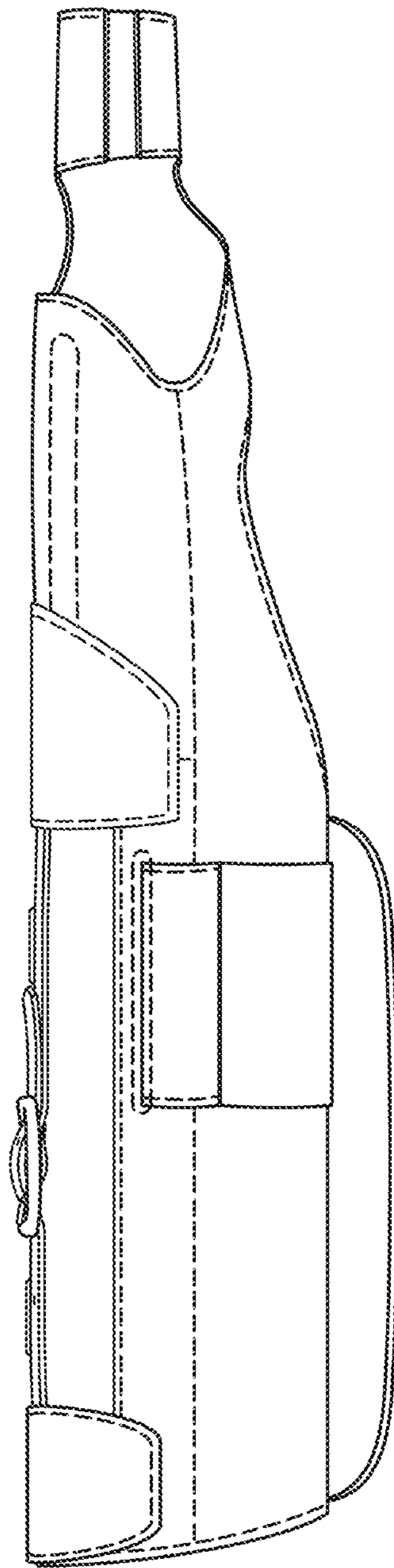

FIG. 4

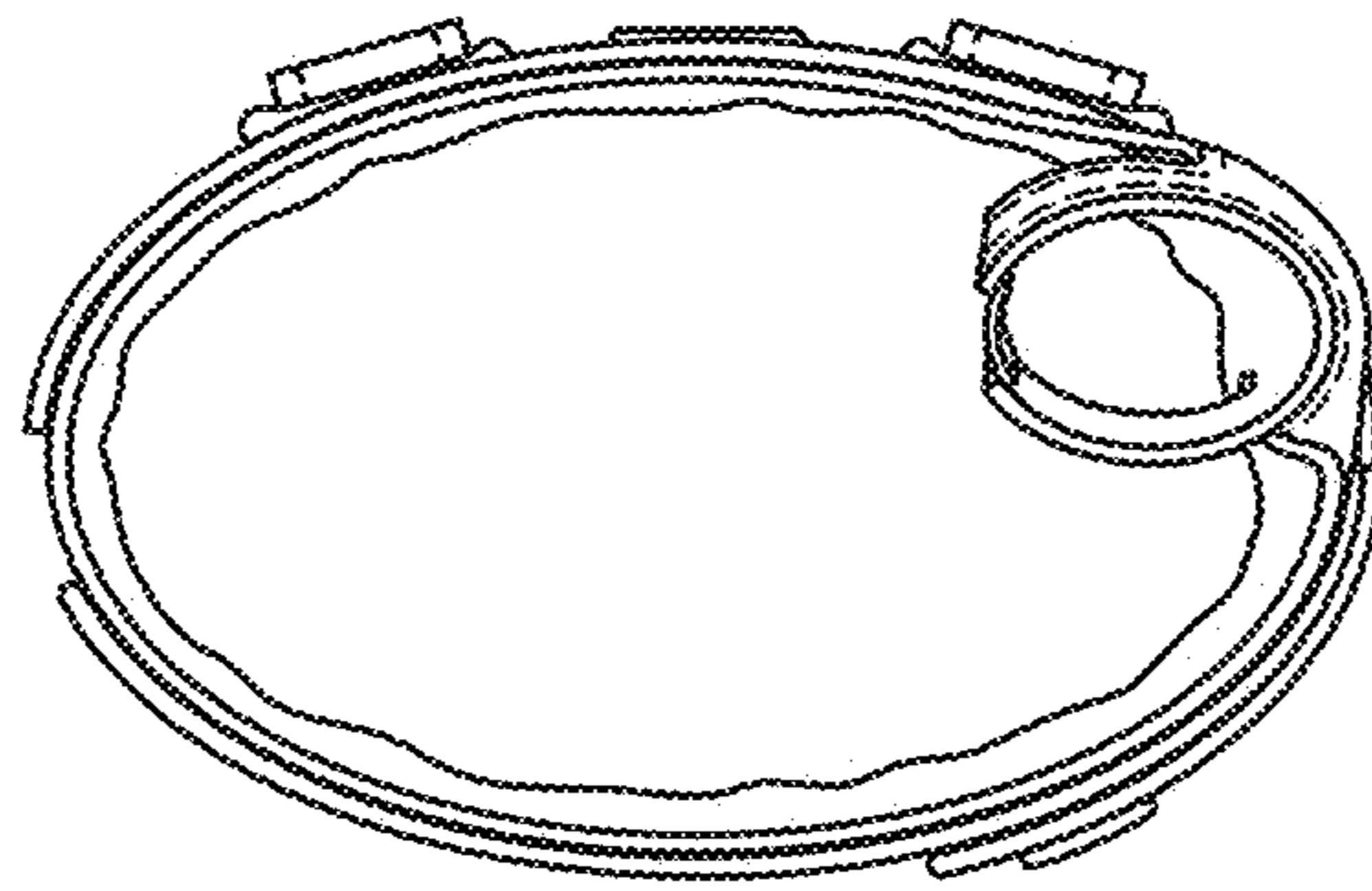

FIG. 5

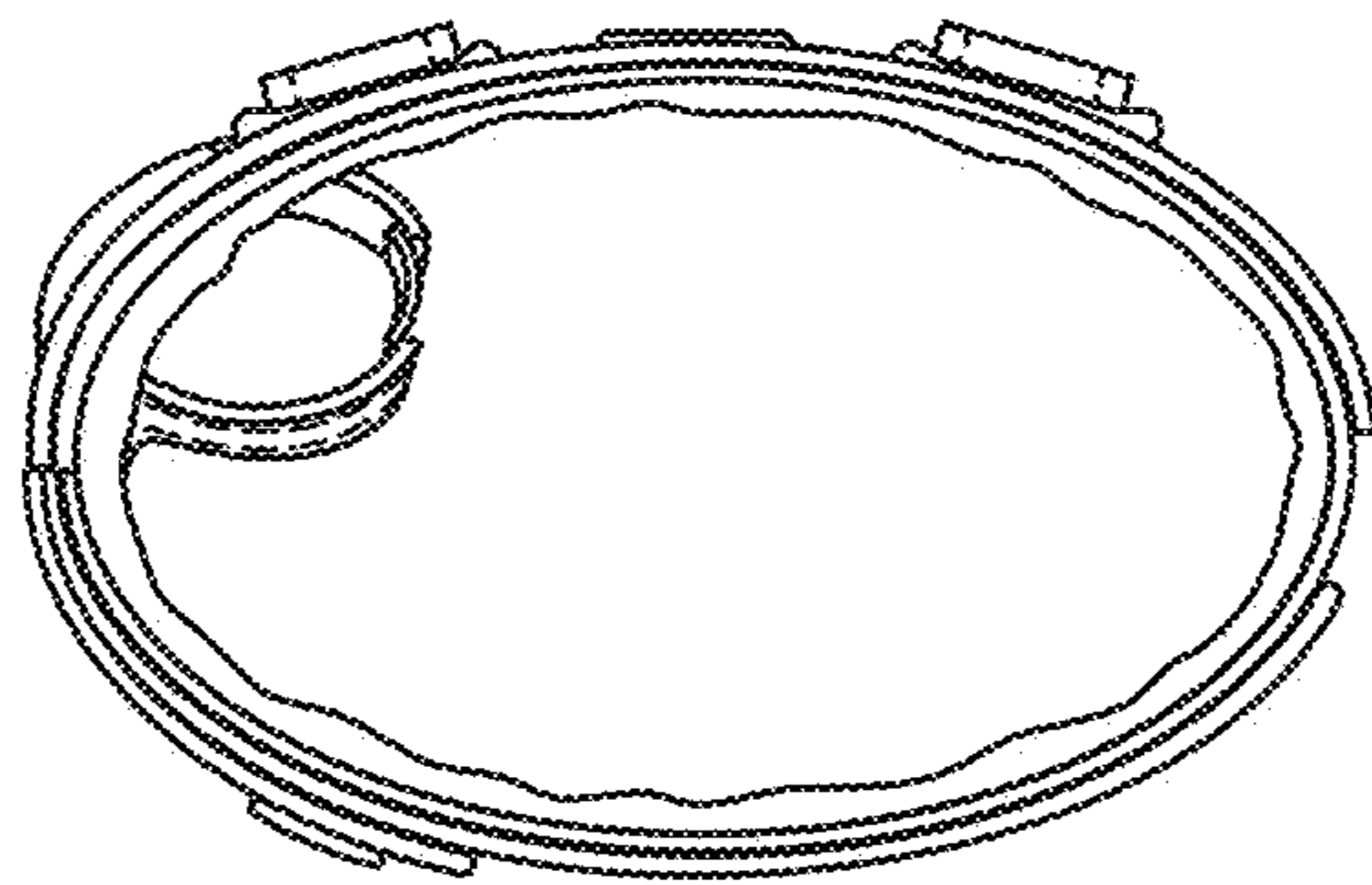

FIG. 6

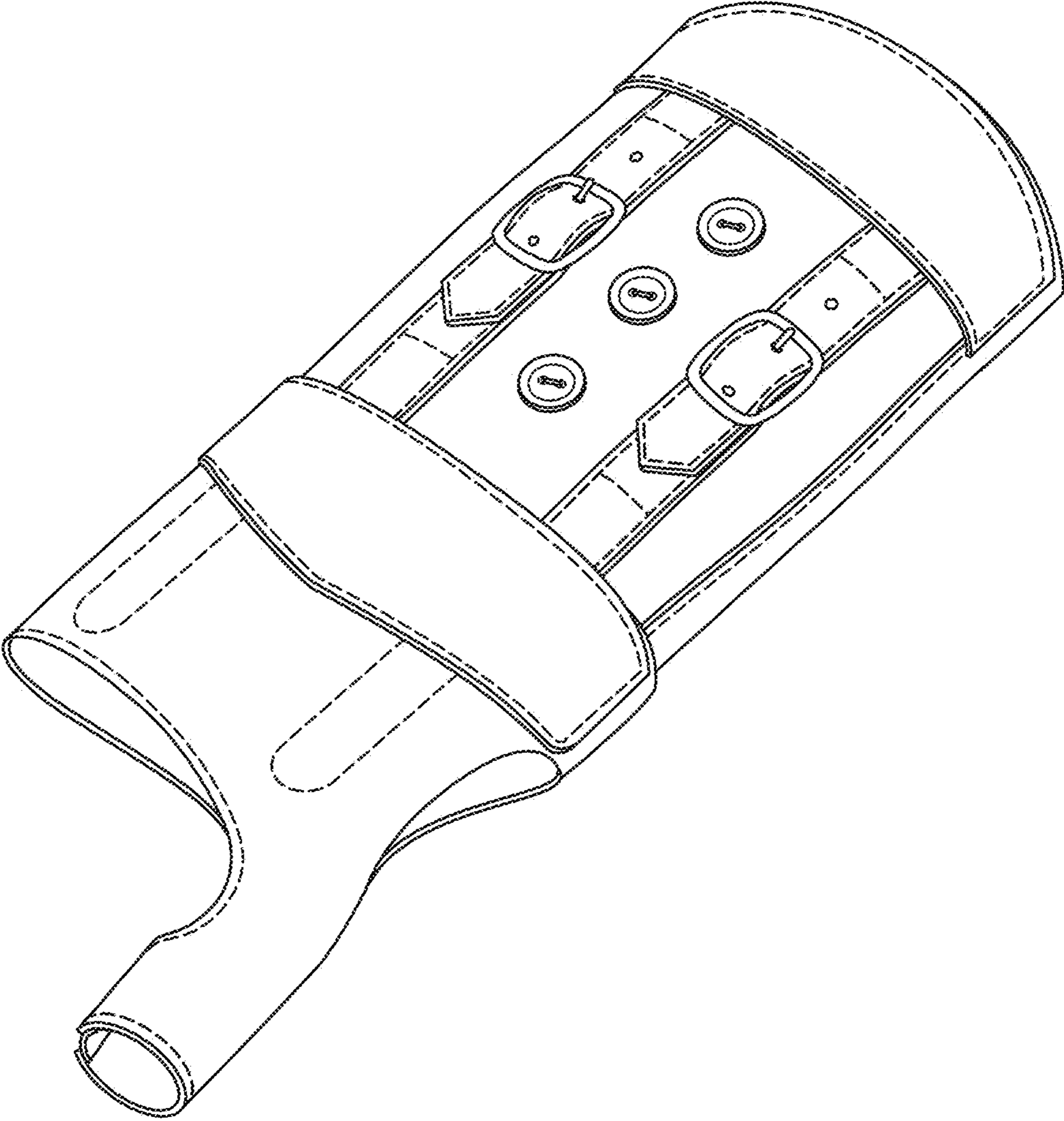

FIG. 7