

US00D739904S

(12) **United States Design Patent**  
**McGrath**

(10) **Patent No.:** **US D739,904 S**

(45) **Date of Patent:** **\*\* Sep. 29, 2015**

(54) **GOLF CLUB HEADCOVER**

(71) Applicant: **Timothy McGrath**, Grosse Pointe Woods, MI (US)

(72) Inventor: **Timothy McGrath**, Grosse Pointe Woods, MI (US)

(\*\*) Term: **14 Years**

(21) Appl. No.: **29/499,905**

(22) Filed: **Aug. 20, 2014**

(51) **LOC (10) Cl.** ..... **21-02**

(52) **U.S. Cl.**  
USPC ..... **D21/754**

(58) **Field of Classification Search**  
USPC ..... D21/754  
CPC ..... A63B 55/007  
See application file for complete search history.

(56) **References Cited**

**U.S. PATENT DOCUMENTS**

|           |     |        |             |           |
|-----------|-----|--------|-------------|-----------|
| 5,488,739 | A   | 2/1996 | Cardinal    |           |
| 5,511,242 | A * | 4/1996 | Bianchi     | 2/16      |
| D369,634  | S * | 5/1996 | Green       | D21/754   |
| D427,384  | S * | 6/2000 | Baillargeon | D29/116.3 |
| D472,951  | S * | 4/2003 | Sullivan    | D21/754   |

|              |      |         |                 |         |
|--------------|------|---------|-----------------|---------|
| D527,778     | S *  | 9/2006  | Mithen          | D21/754 |
| D603,920     | S *  | 11/2009 | Heazel          | D21/754 |
| D670,777     | S    | 11/2012 | Roberts         |         |
| 8,640,263    | B2 * | 2/2014  | Copeland et al. | 2/161.1 |
| 2008/0222763 | A1 * | 9/2008  | Jourde et al.   | 2/16    |

**OTHER PUBLICATIONS**

<http://www.golfwrx.com/105026/graham-delaet-witb/>; Nov. 11, 2013.

\* cited by examiner

*Primary Examiner* — Mithcell Siegel

(74) *Attorney, Agent, or Firm* — Bejin Bieneman PLC

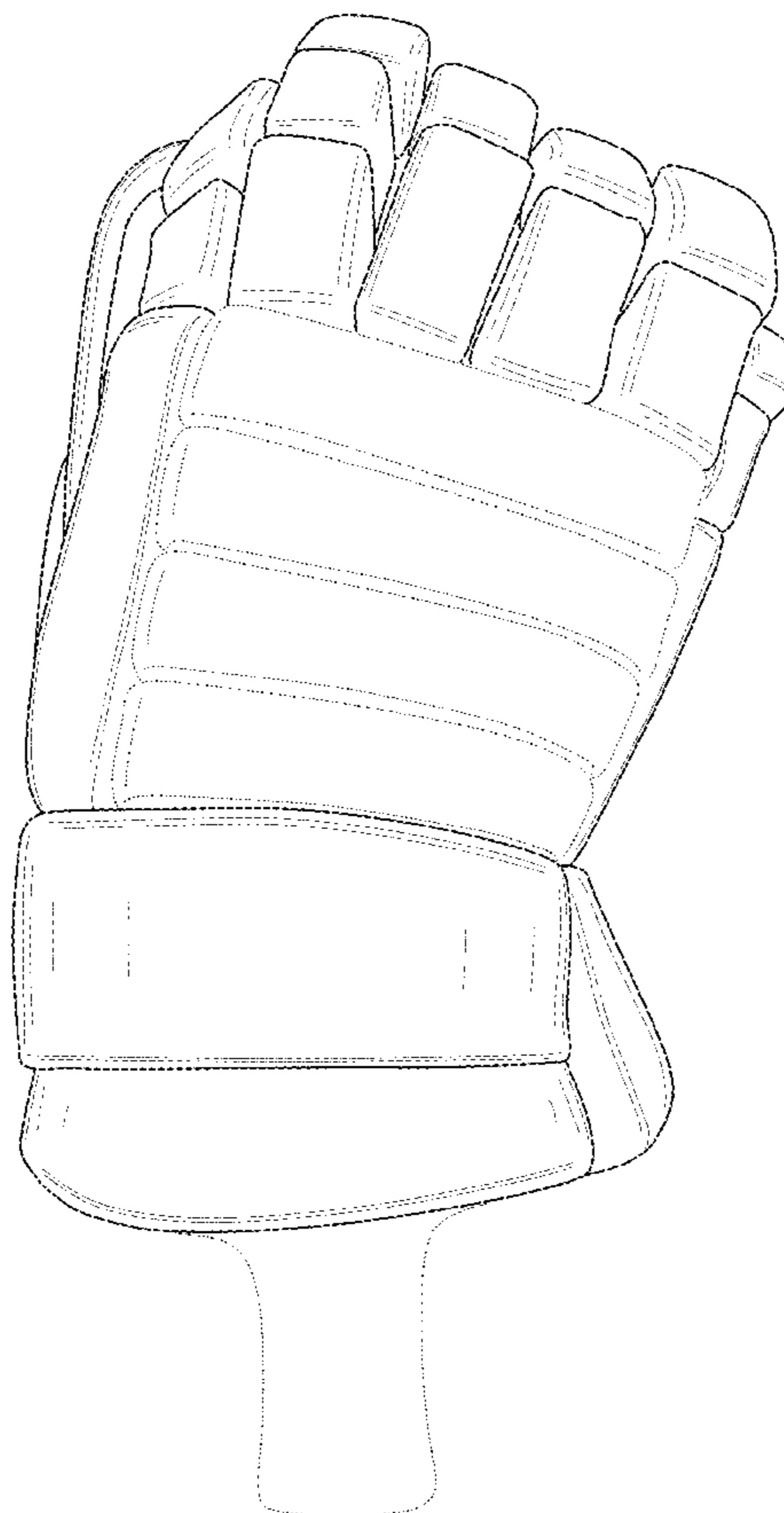
(57) **CLAIM**

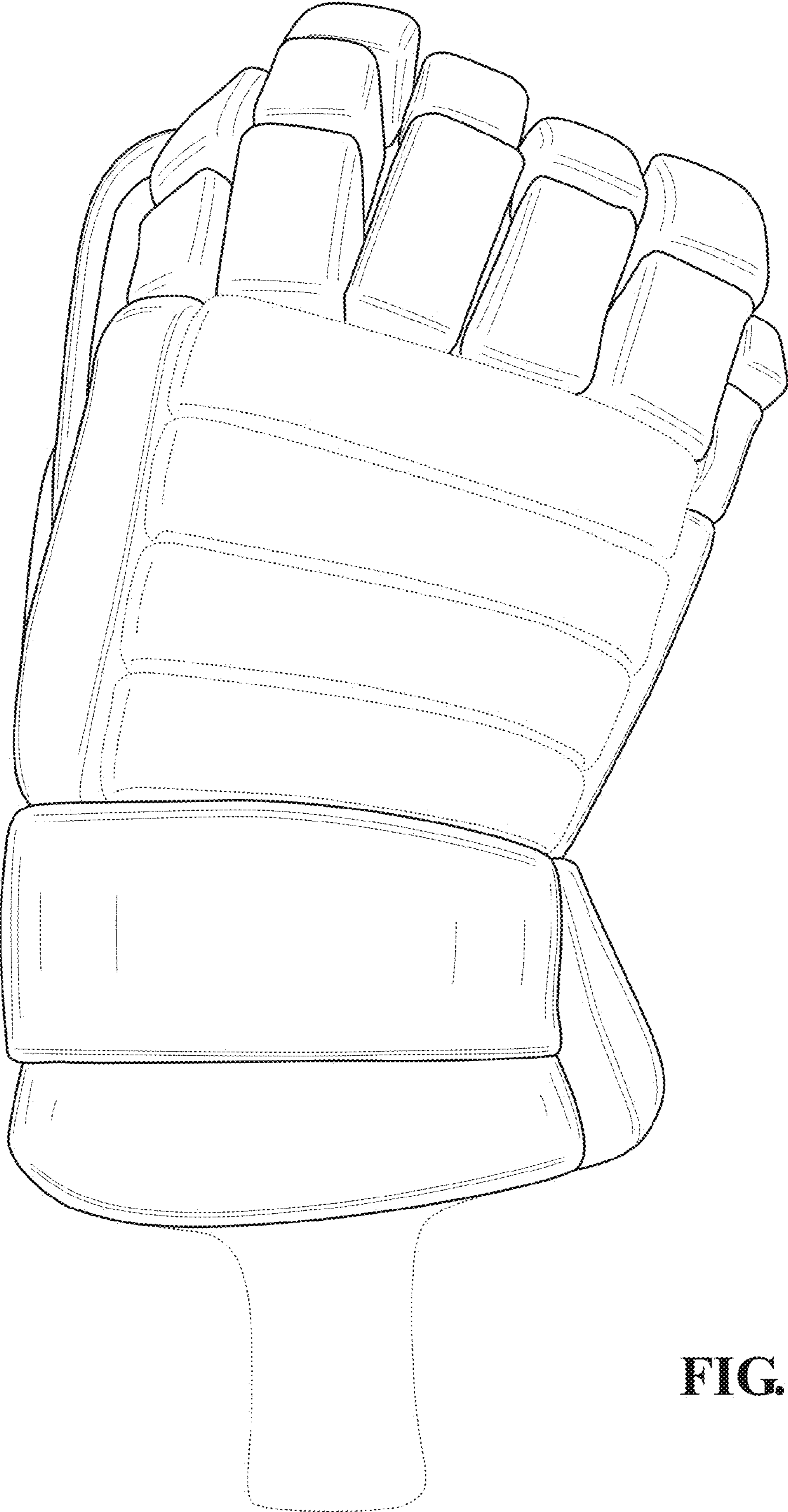
The ornamental design for a golf club headcover, as shown and described.

**DESCRIPTION**

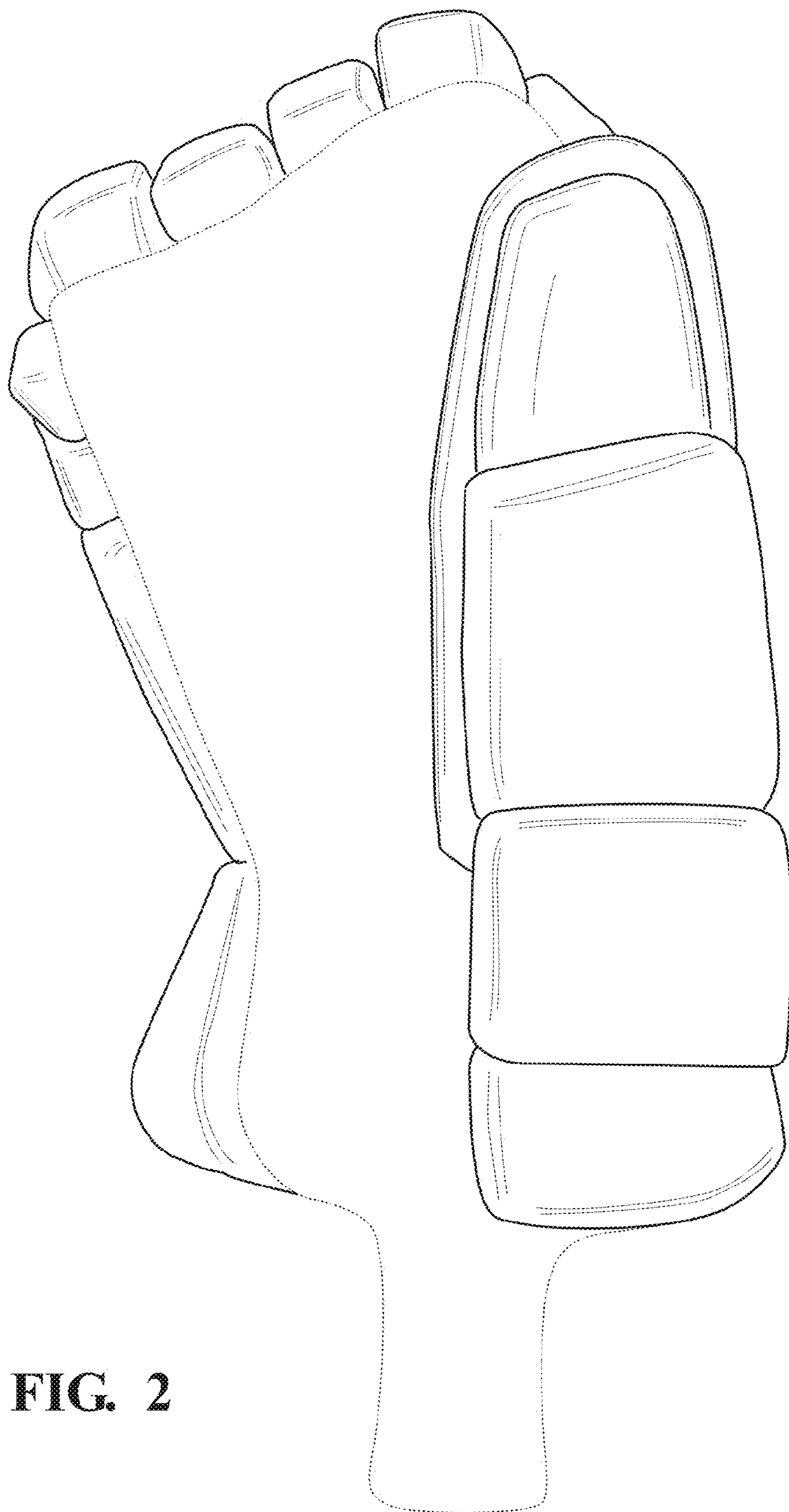
FIG. 1 is a rear view of a golf club headcover; FIG. 2 is a front view of the golf club headcover; FIG. 3 is a right side view of the golf club headcover; FIG. 4 is a left side view of the golf club headcover; FIG. 5 is a top view of the golf club headcover; and, FIG. 6 is a bottom view of the golf club headcover. The broken line showing is included for the purpose of illustrating and forms no part of the claimed design.

**1 Claim, 5 Drawing Sheets**

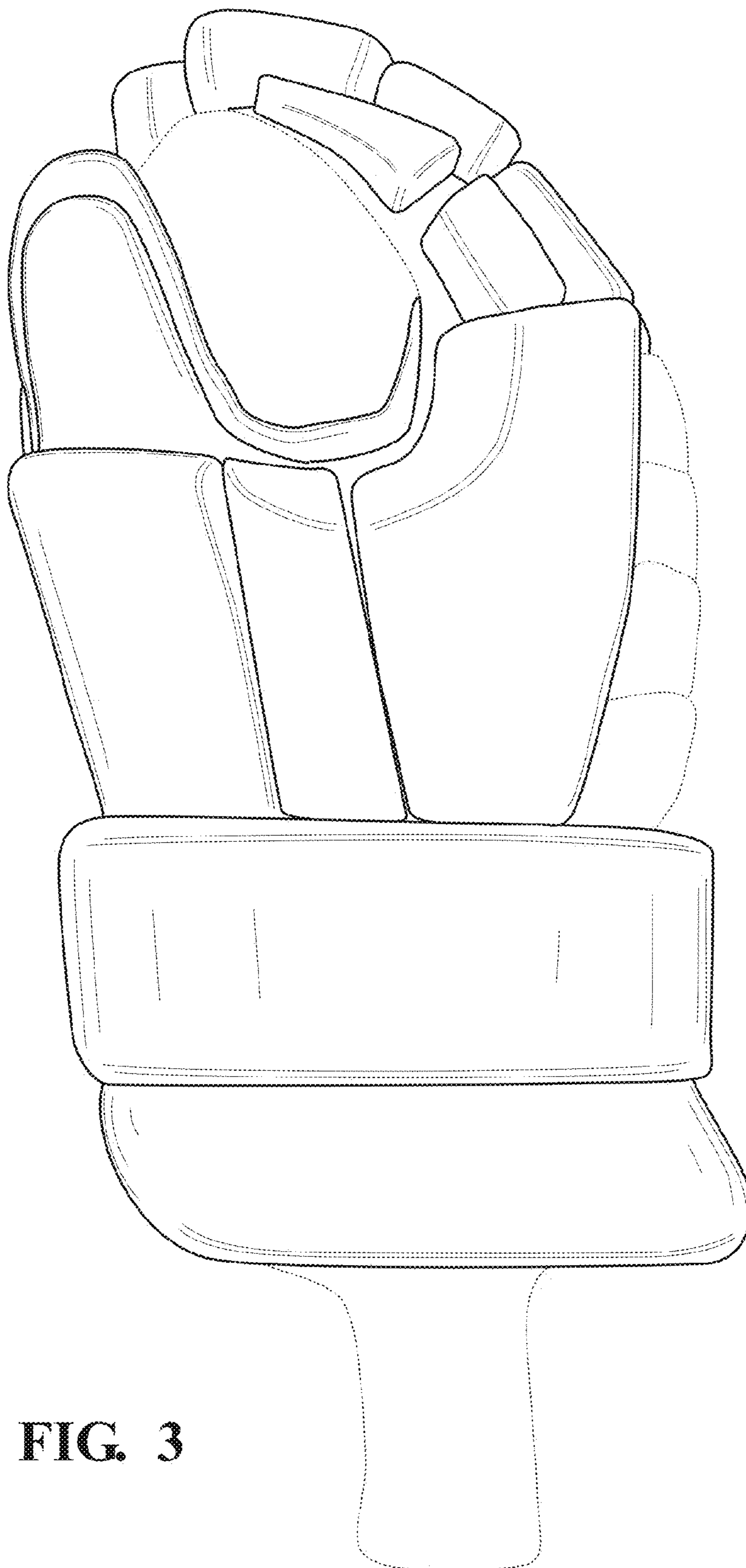




**FIG. 1**



**FIG. 2**



**FIG. 3**

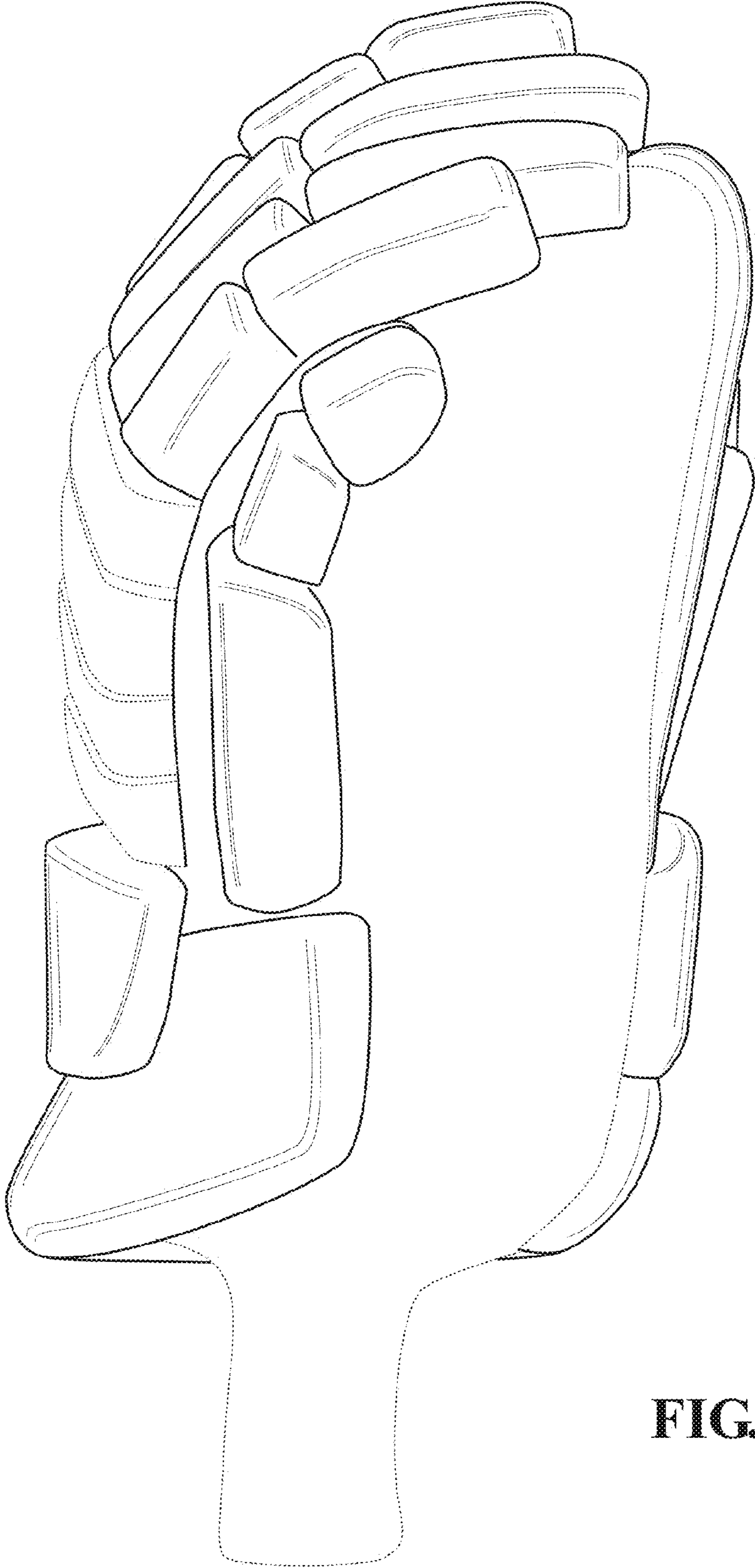
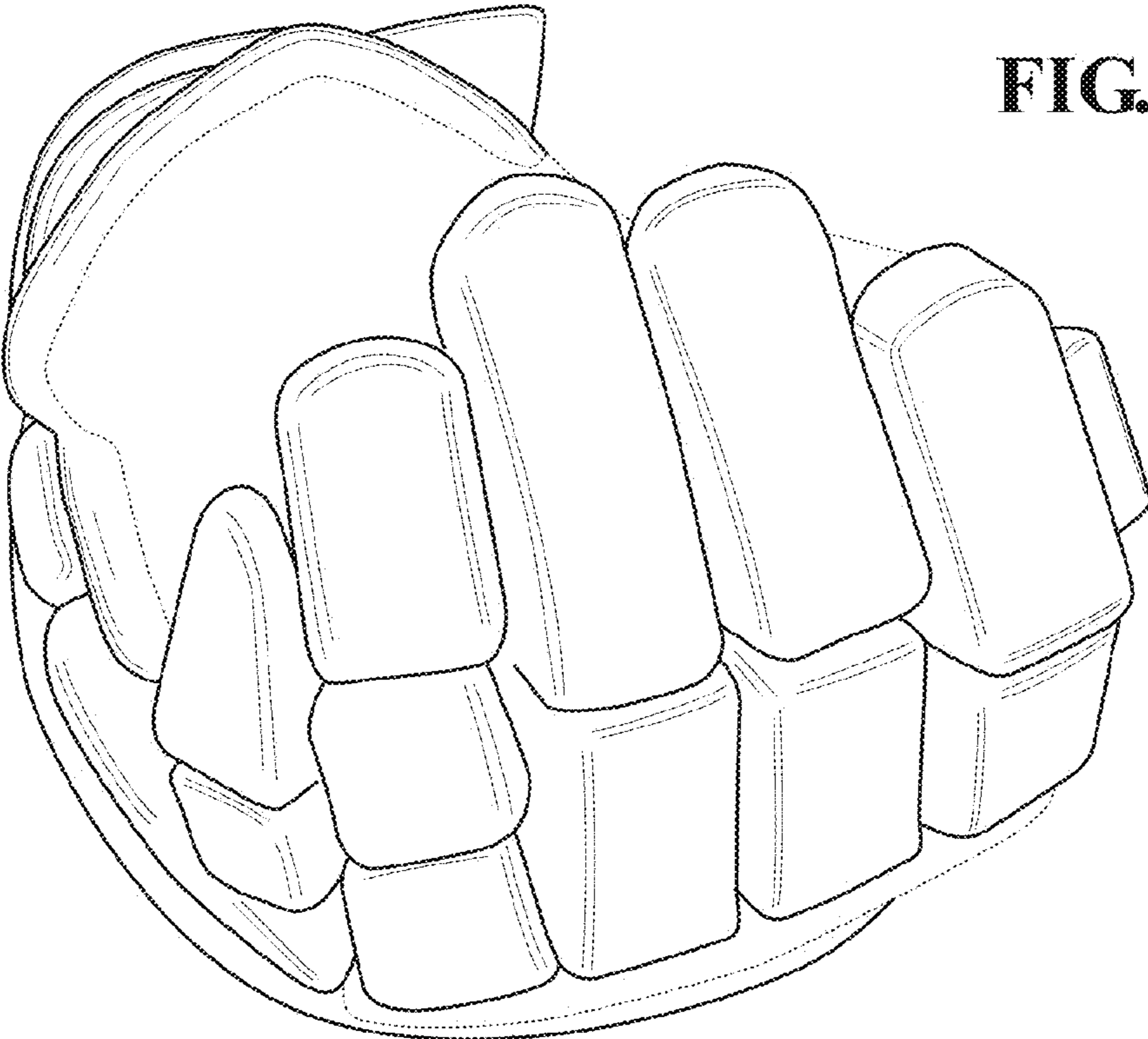
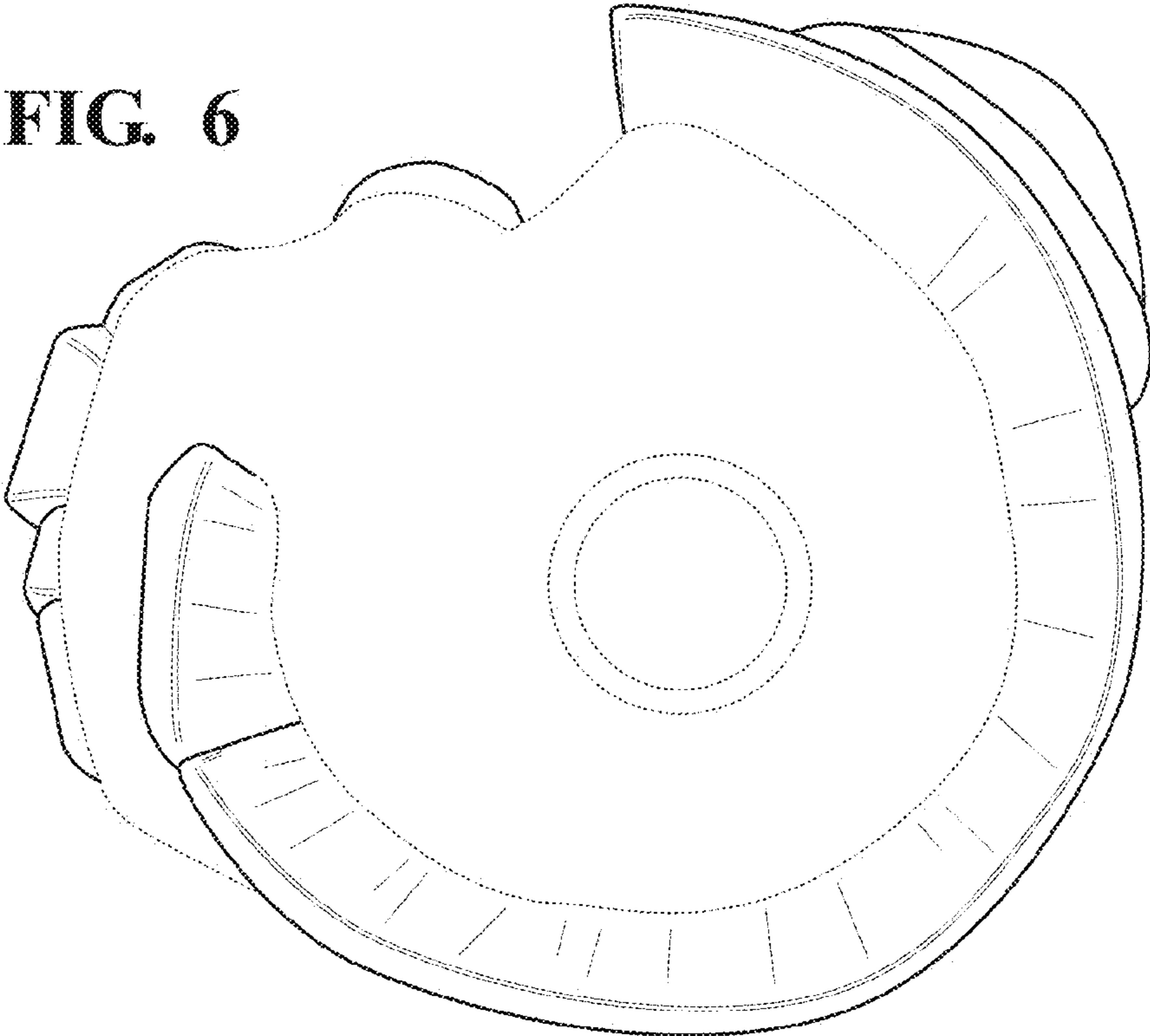


FIG. 4



**FIG. 5**



**FIG. 6**