



US00D739848S

(12) **United States Design Patent**
Brown et al.

(10) **Patent No.:** **US D739,848 S**

(45) **Date of Patent:** **** Sep. 29, 2015**

(54) **AUDIO SPEAKER**

(71) Applicant: **GENERAL WIRELESS IP HOLDINGS LLC**, Fort Worth, TX (US)

(72) Inventors: **Darrell M. Brown**, Fort Worth, TX (US); **Danny E. Ramirez**, Mansfield, TX (US)

(73) Assignee: **General Wireless IP Holdings LLC**, Fort Worth, TX (US)

(**) Term: **14 Years**

(21) Appl. No.: **29/455,371**

(22) Filed: **May 20, 2013**

(51) **LOC (10) Cl.** **14-03**

(52) **U.S. Cl.**
USPC **D14/219**; D14/210; D14/214

(58) **Field of Classification Search**
USPC D14/167, 168, 170–172, 188, 194–196, D14/204, 207, 209.1, 210–216, 219, 221, D14/222, 224, 496; 181/143, 144, 147, 148, 181/150, 153, 157, 198, 199; 381/300–303, 381/306, 332, 333, 336, 345, 361–364, 381/386–388; 369/6–12
CPC B60R 11/0217; G06F 1/1688; H04M 1/03; H04M 1/035; H04R 1/02; H04R 1/06; H04R 1/021; H04R 1/025; H04R 1/026; H04R 1/028; H04R 1/105; H04R 1/323; H04R 1/403; H04R 1/2803; H04R 1/2834; H04R 5/02; H04R 7/20; H04R 9/06; H04R 9/025; H04R 2201/021; H04R 2400/00; H04R 2400/07; H04R 2499/11; H04R 2499/13; H04R 2499/15; H04S 3/00; H04S 7/30
See application file for complete search history.

(56) **References Cited**

U.S. PATENT DOCUMENTS

D370,680 S * 6/1996 Kobayashi D14/214
D579,939 S * 11/2008 Skillman et al. D14/432

(Continued)

OTHER PUBLICATIONS

Radio Shack Circular for Dec. 16, 2012 through Dec. 22, 2012, 1 page.

RadioShack.com, “Auvio Bluetooth Portable Speaker”, Mar. 14, 2013, accessed Nov. 19, 2013, web.archive.org/web/20130314023150/http://www.radioshack.com/home/index.jsp.

(Continued)

Primary Examiner — Keli L Hill

(74) *Attorney, Agent, or Firm* — Haynes and Boone, LLP

(57) **CLAIM**

The ornamental design for a audio speaker, as shown and described.

DESCRIPTION

FIG. 1 is a perspective view of a audio speaker showing our new design according to a first embodiment; FIG. 2 is a front elevational view of the first embodiment; FIG. 3 is a rear elevational view of the first embodiment; FIG. 4 is a right side elevational view of the first embodiment; FIG. 5 is a left side elevational view of the first embodiment; FIG. 6 is a top plan view of the first embodiment; FIG. 7 is a bottom plan view of the first embodiment; FIG. 8 is a perspective view of a audio speaker showing our new design according to a second embodiment; FIG. 9 is a front elevational view of the second embodiment; FIG. 10 is a rear elevational view of the second embodiment; FIG. 11 is a right side elevational view of the second embodiment; FIG. 12 is a left side elevational view of the second embodiment; FIG. 13 is a top plan view of the second embodiment; FIG. 14 is a bottom plan view of the second embodiment; FIG. 15 is a perspective view of a audio speaker showing our new design according to a third embodiment; FIG. 16 is a front elevational view of the third embodiment; FIG. 17 is a rear elevational view of the third embodiment; FIG. 18 is a right side elevational view of the third embodiment; FIG. 19 is a left side elevational view of the third embodiment; FIG. 20 is a top plan view of the third embodiment; and, FIG. 21 is a bottom plan view of the third embodiment. The stippling shown in FIGS. 1, 2, 6, 8, 9, 13, 15 and 16 illustrate small circular openings. The broken lines in FIGS. 1-21 form no part of the claimed design.

1 Claim, 18 Drawing Sheets

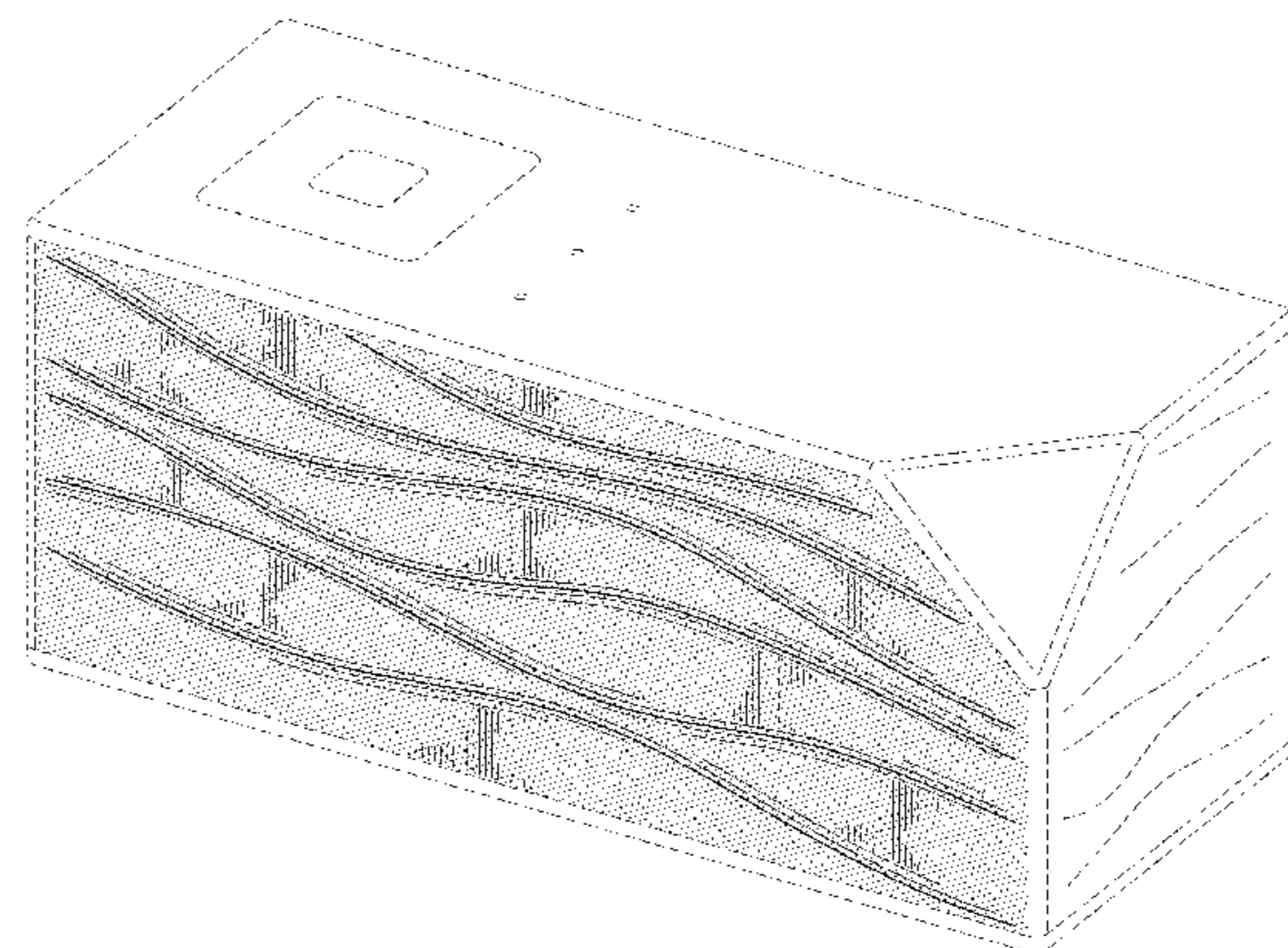
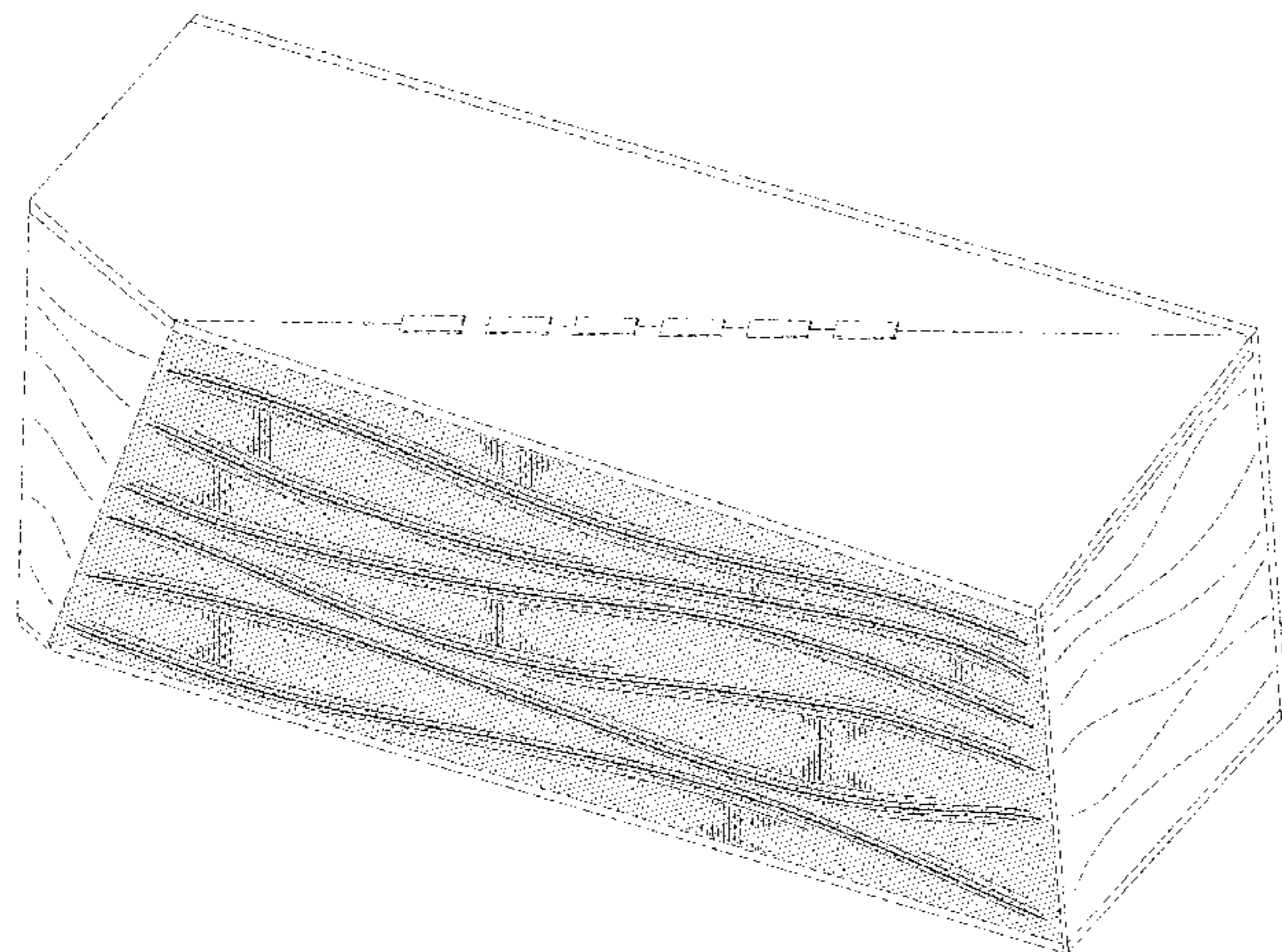

(56)

References Cited

U.S. PATENT DOCUMENTS

| | | | |
|-------------------|--------|-------------------|---------|
| D645,024 S | 9/2011 | Behar et al. | |
| D652,019 S | 1/2012 | Behar et al. | |
| D652,020 S | 1/2012 | Behar et al. | |
| D655,689 S | 3/2012 | Behar et al. | |
| D687,816 S * | 8/2013 | Lee | D14/221 |
| D698,759 S * | 2/2014 | Behar et al. | D14/219 |
| 2013/0177196 A1 * | 7/2013 | Lee | 381/391 |

OTHER PUBLICATIONS

Youtube, "RadioShack Closer Look—Auvio Bluetooth Portable Speaker", published Nov. 1, 2012, www.youtube.com/watch?v=mJ_Gzzzpkbs.
U.S. Trademark Application Serial No. 85695152 filed Aug. 3, 2012, 2 pages.
U.S. Trademark Application Serial No. 85695176 filed Aug. 3, 2012, 2 pages.

* cited by examiner

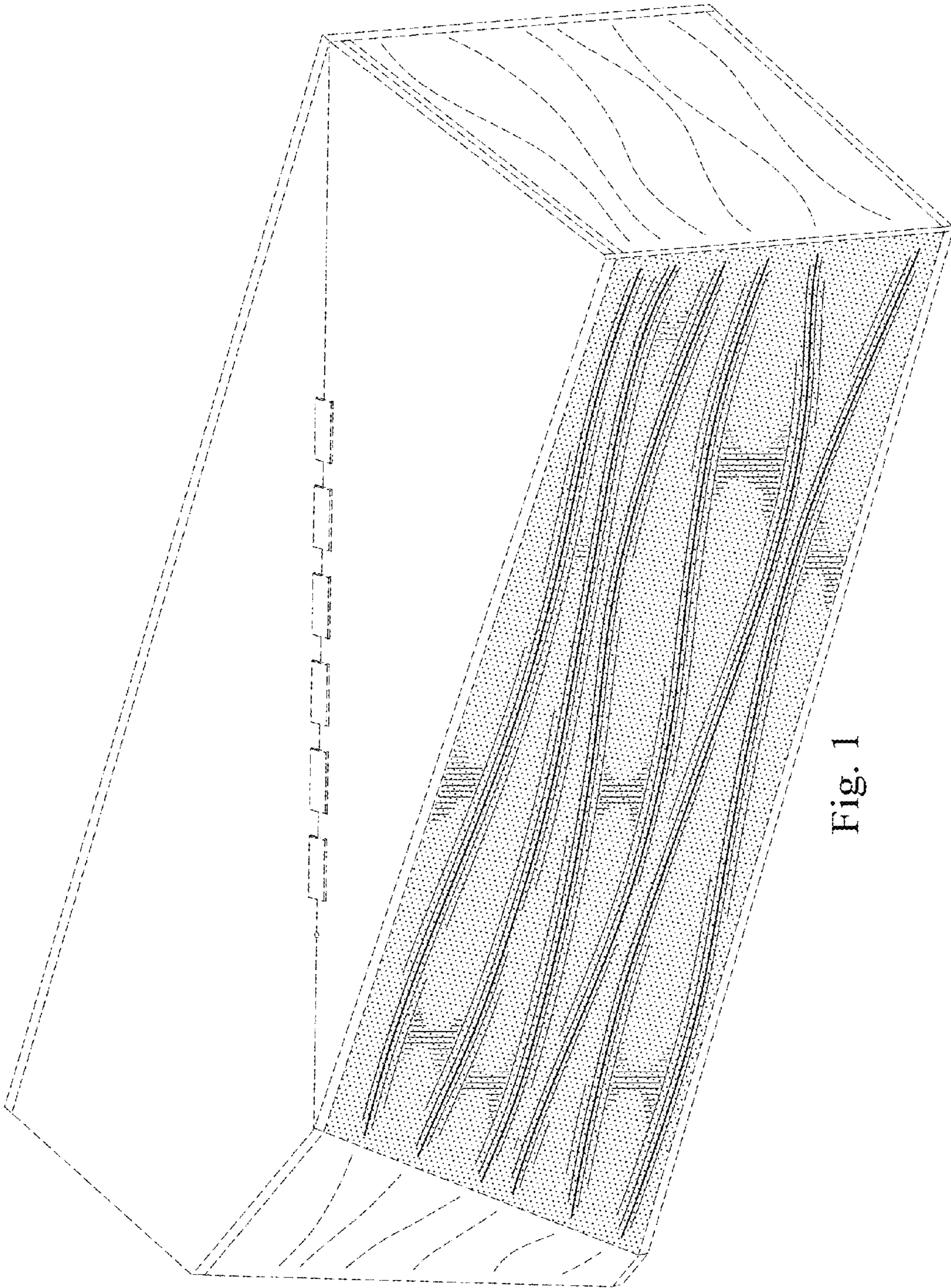

Fig. 1

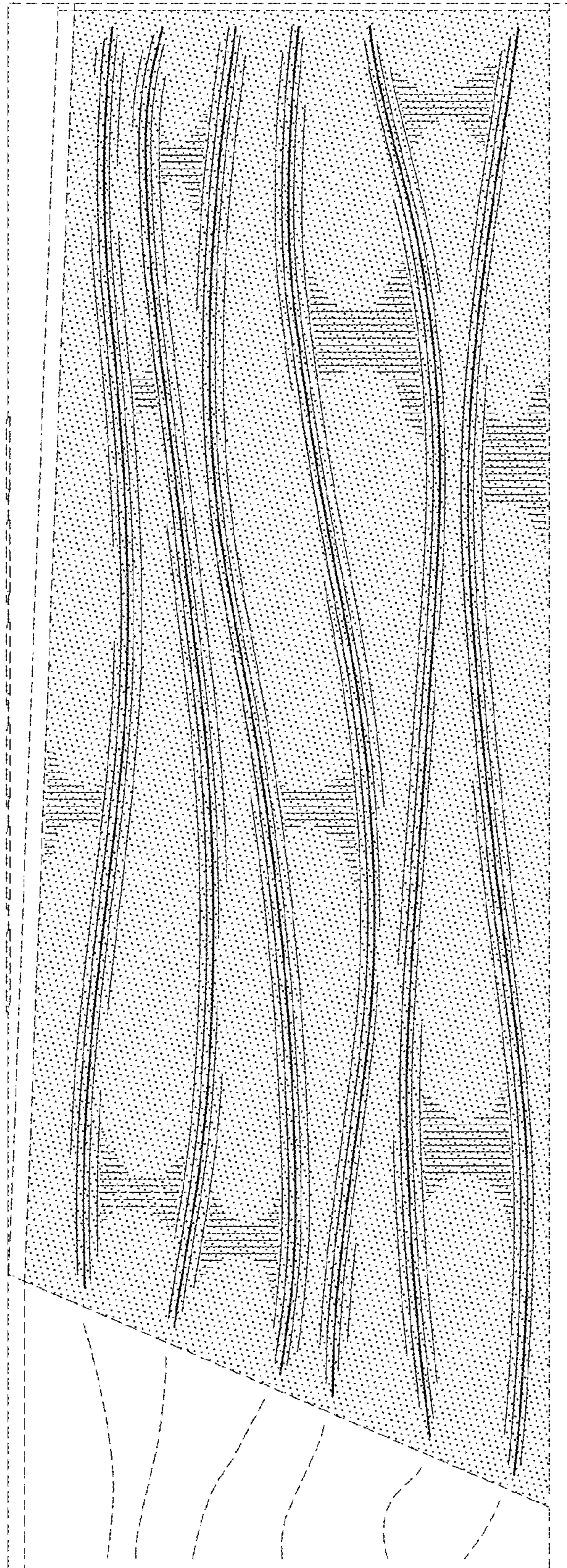

Fig. 2

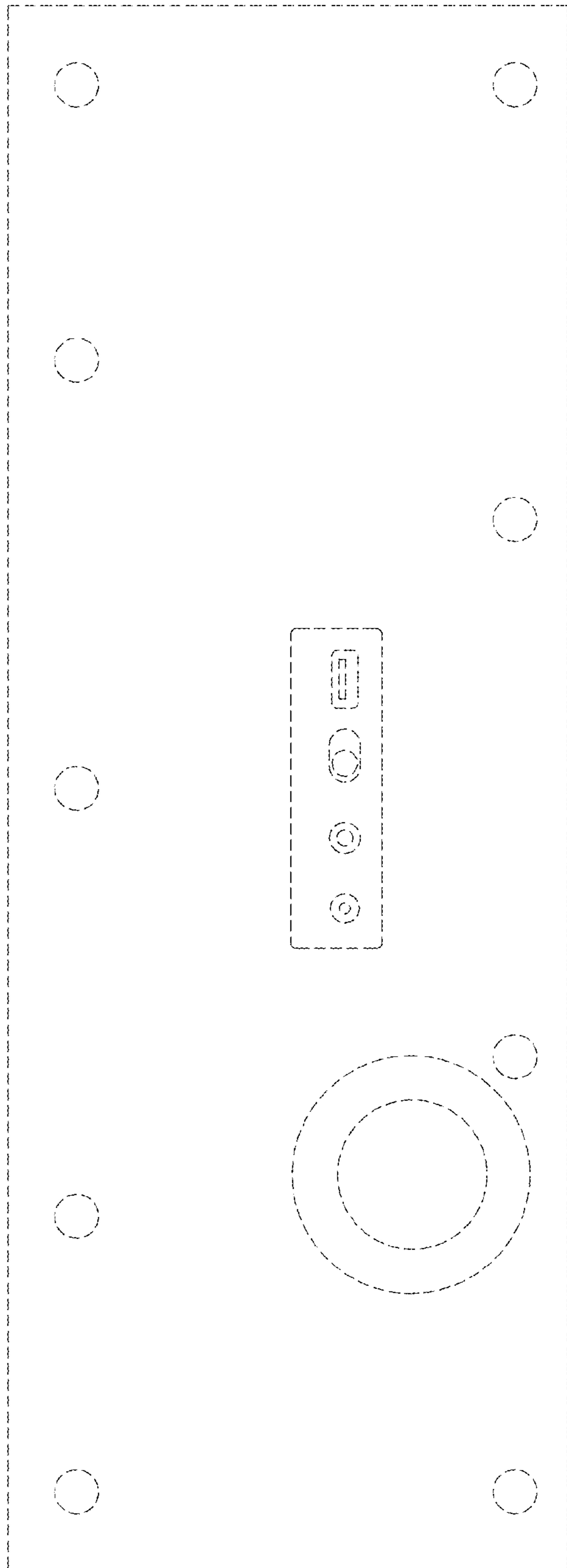

Fig. 3

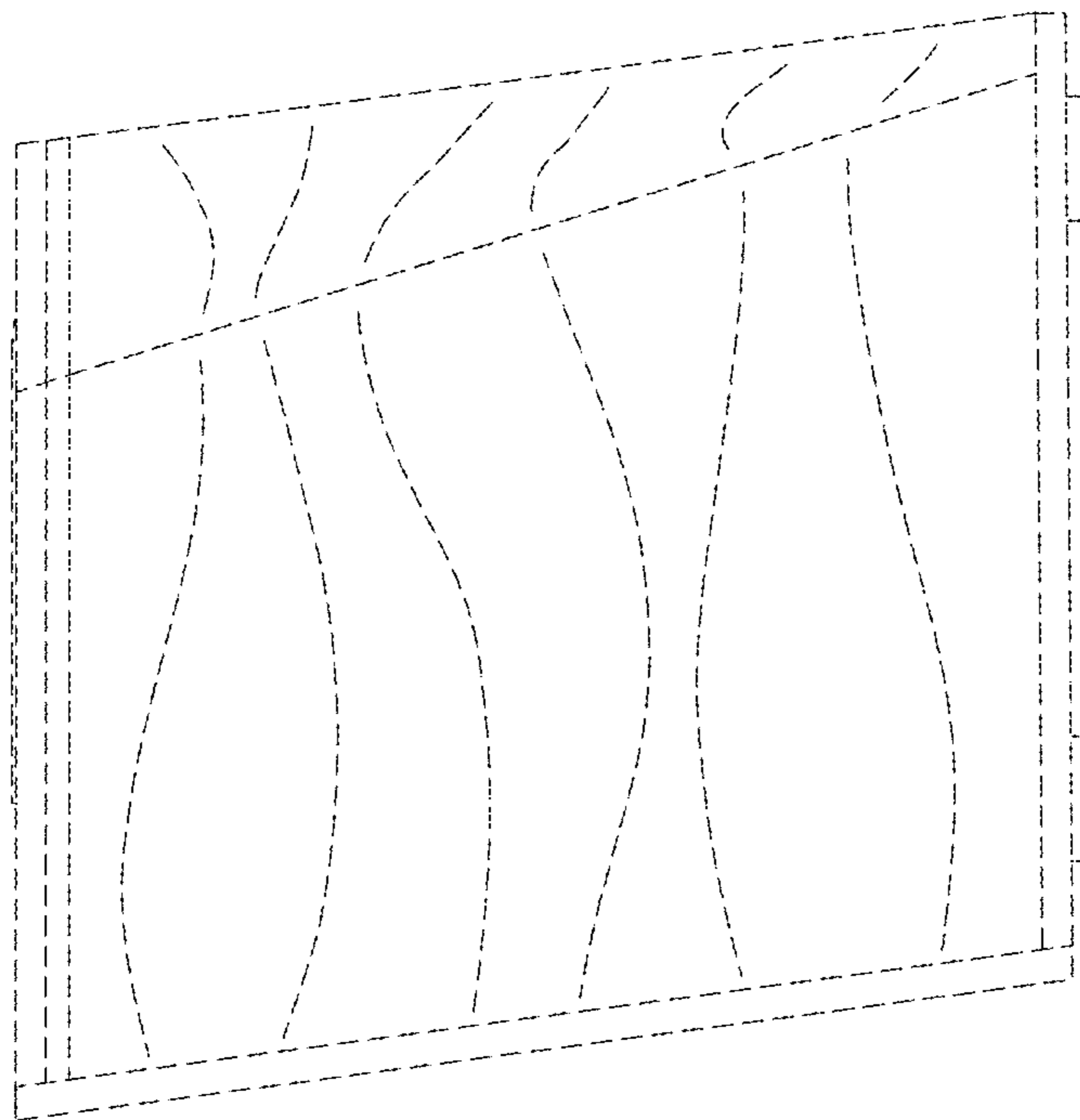

Fig. 5

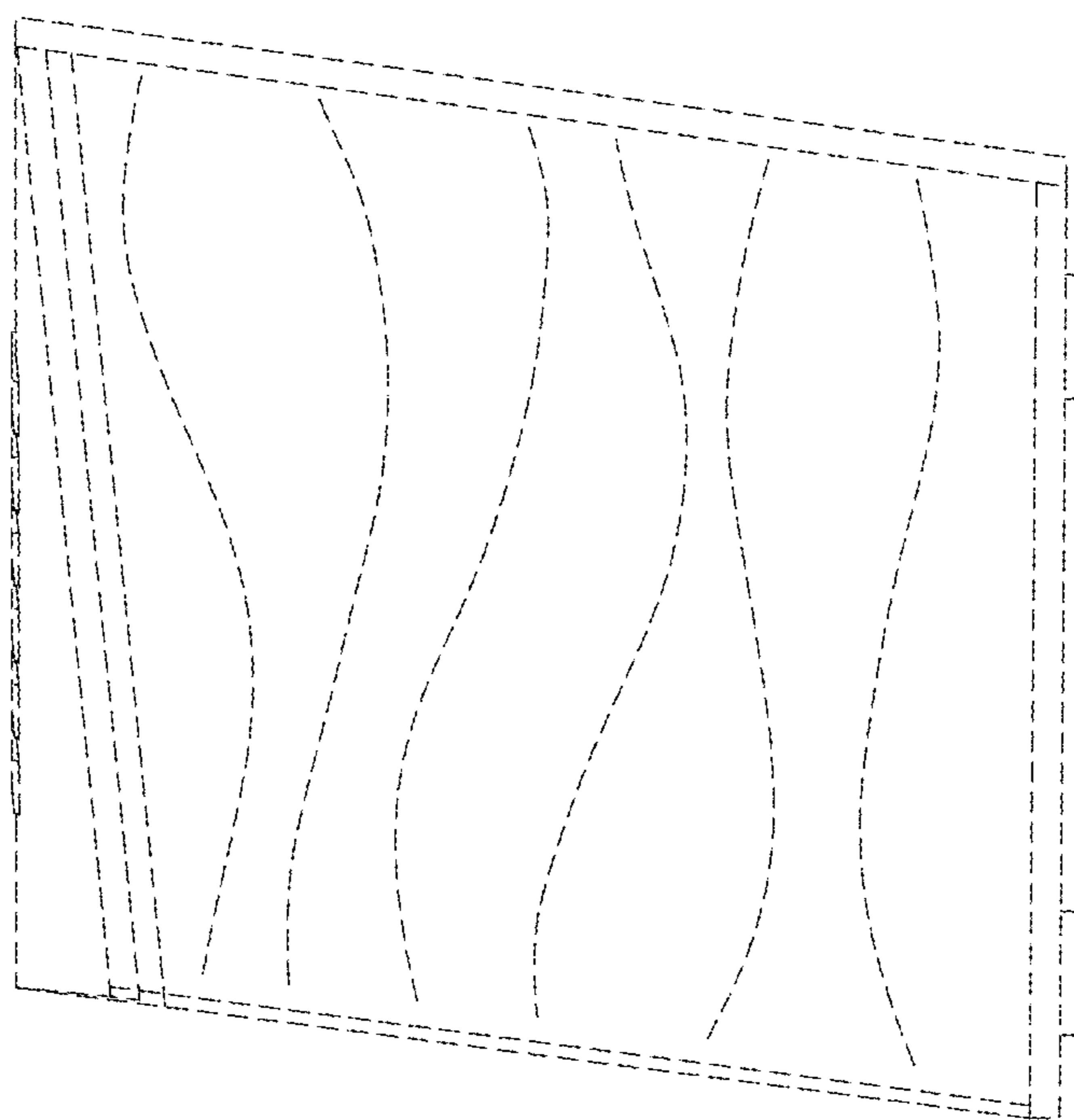

Fig. 4

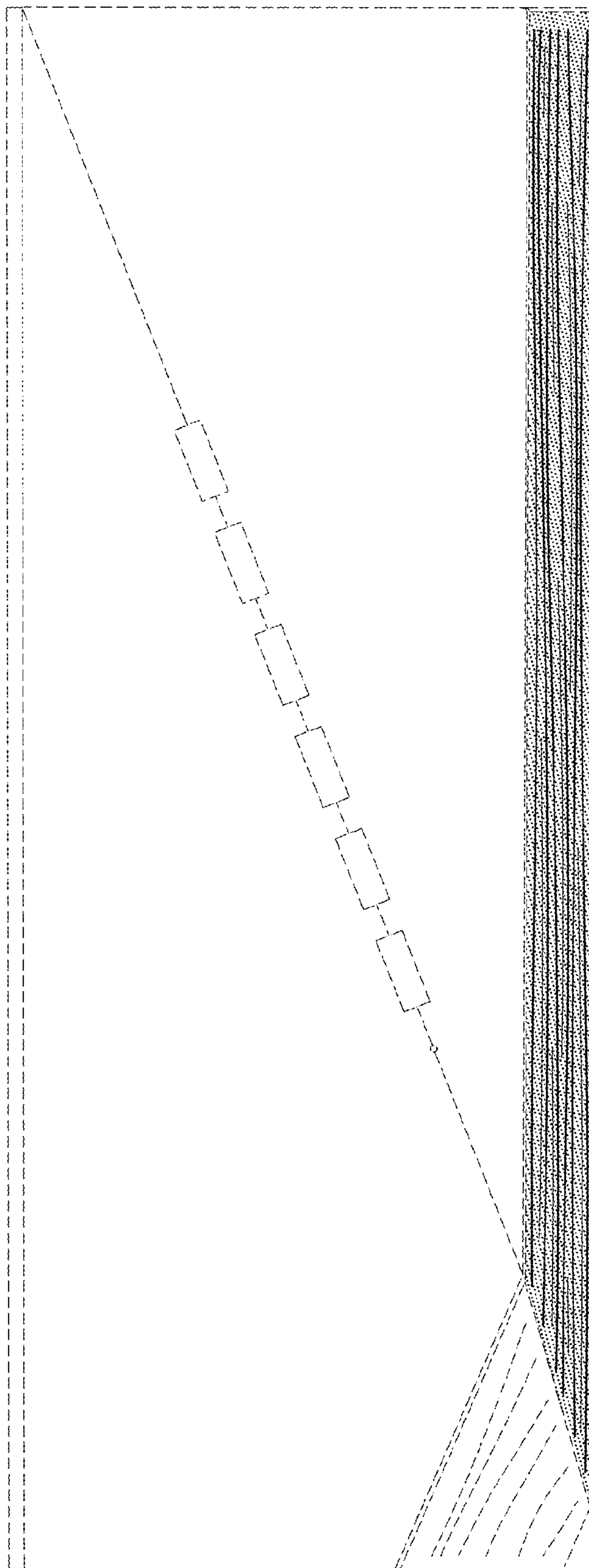

Fig. 6

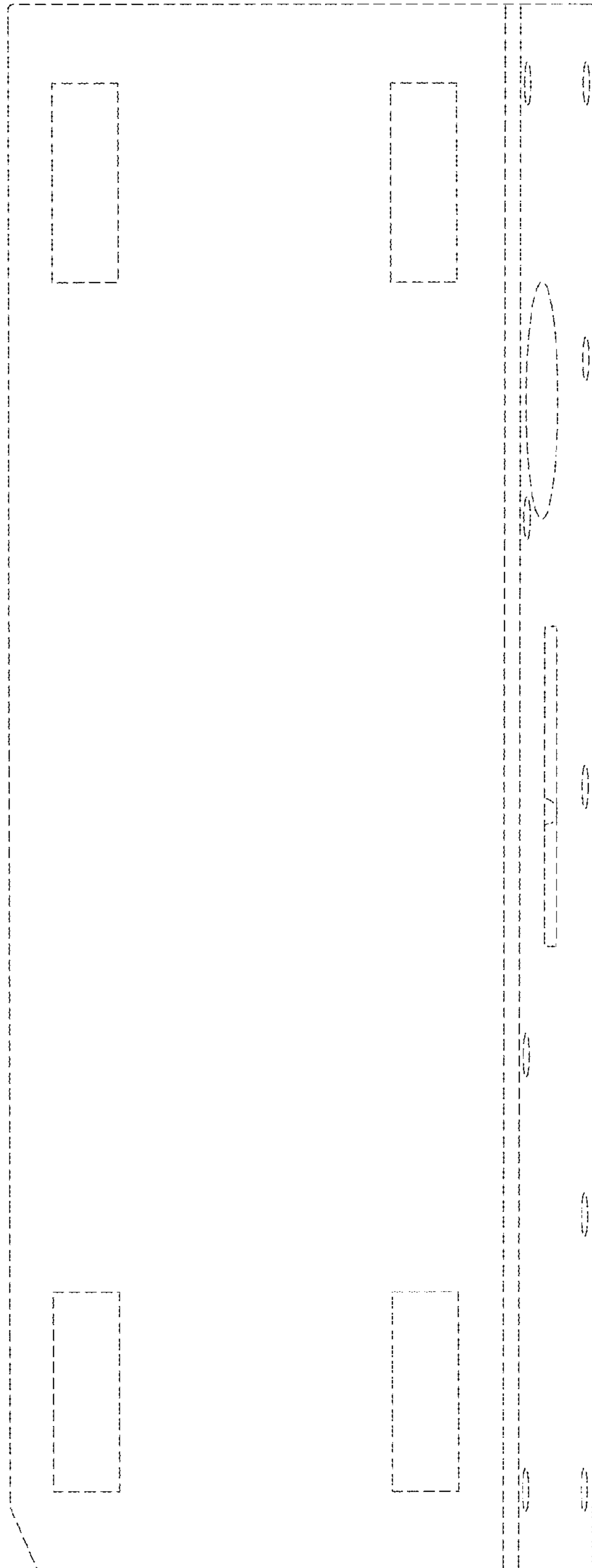

Fig. 7

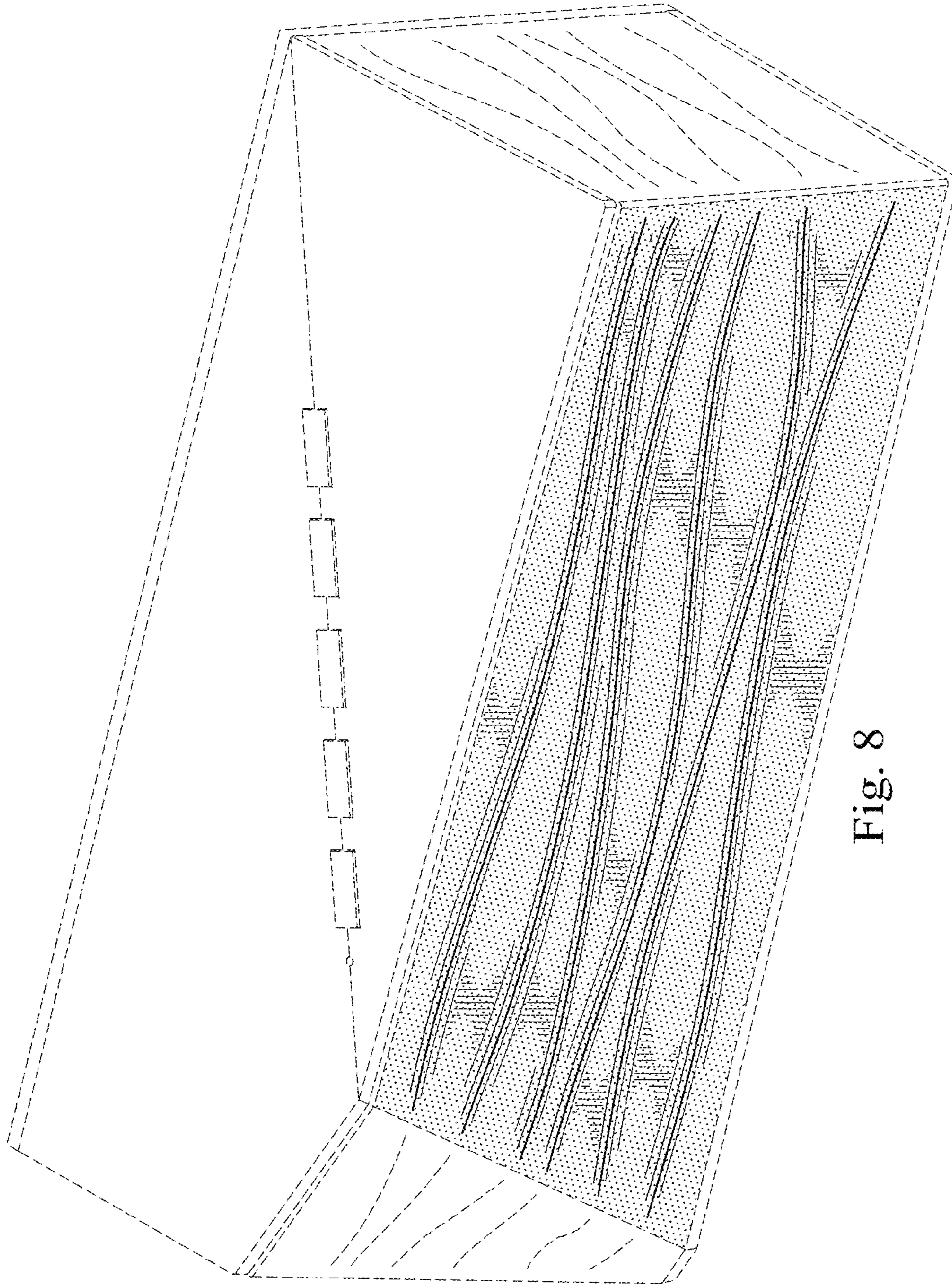

Fig. 8

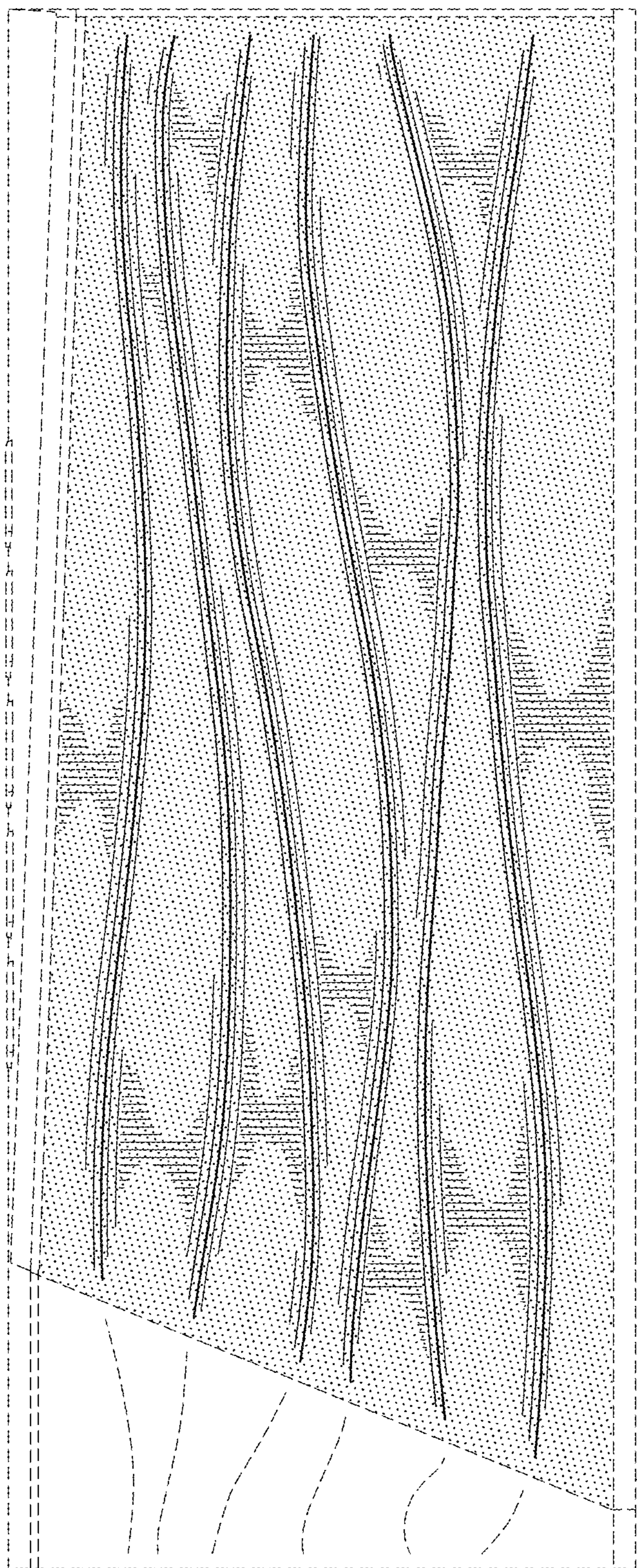

Fig. 9

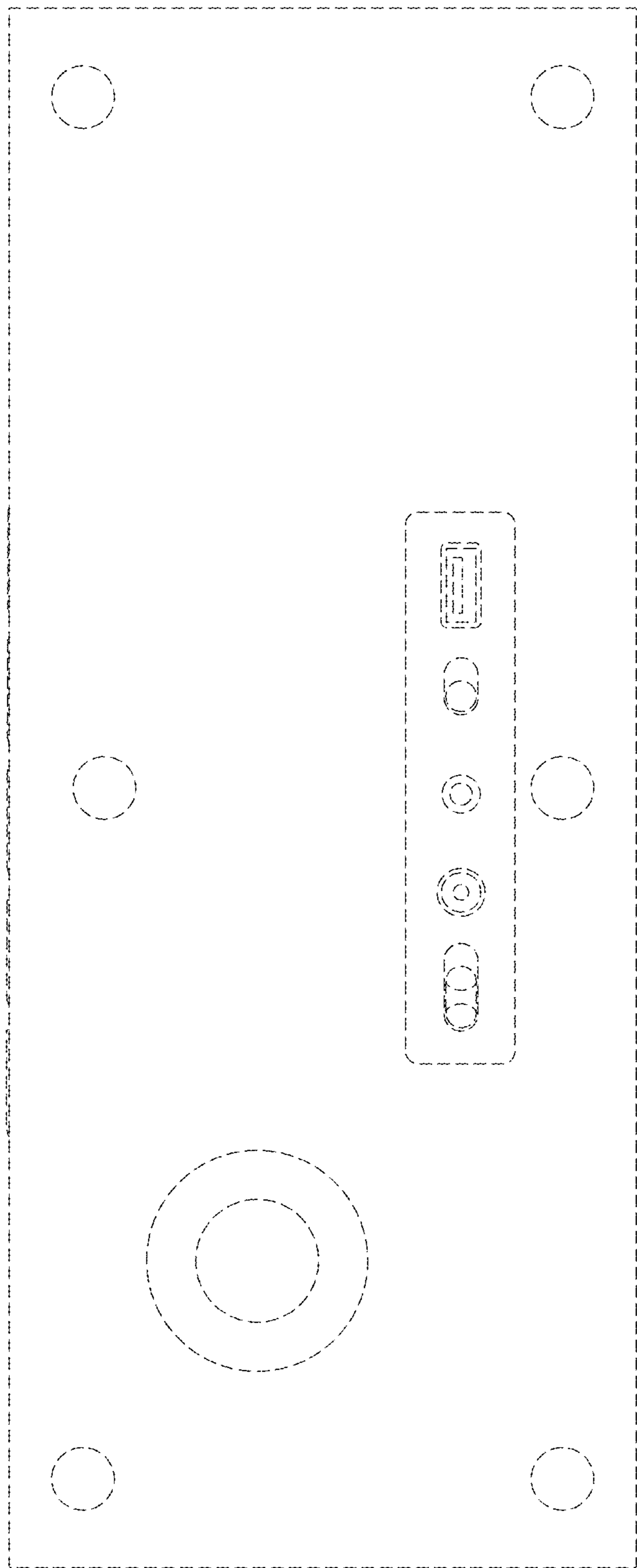

Fig. 10

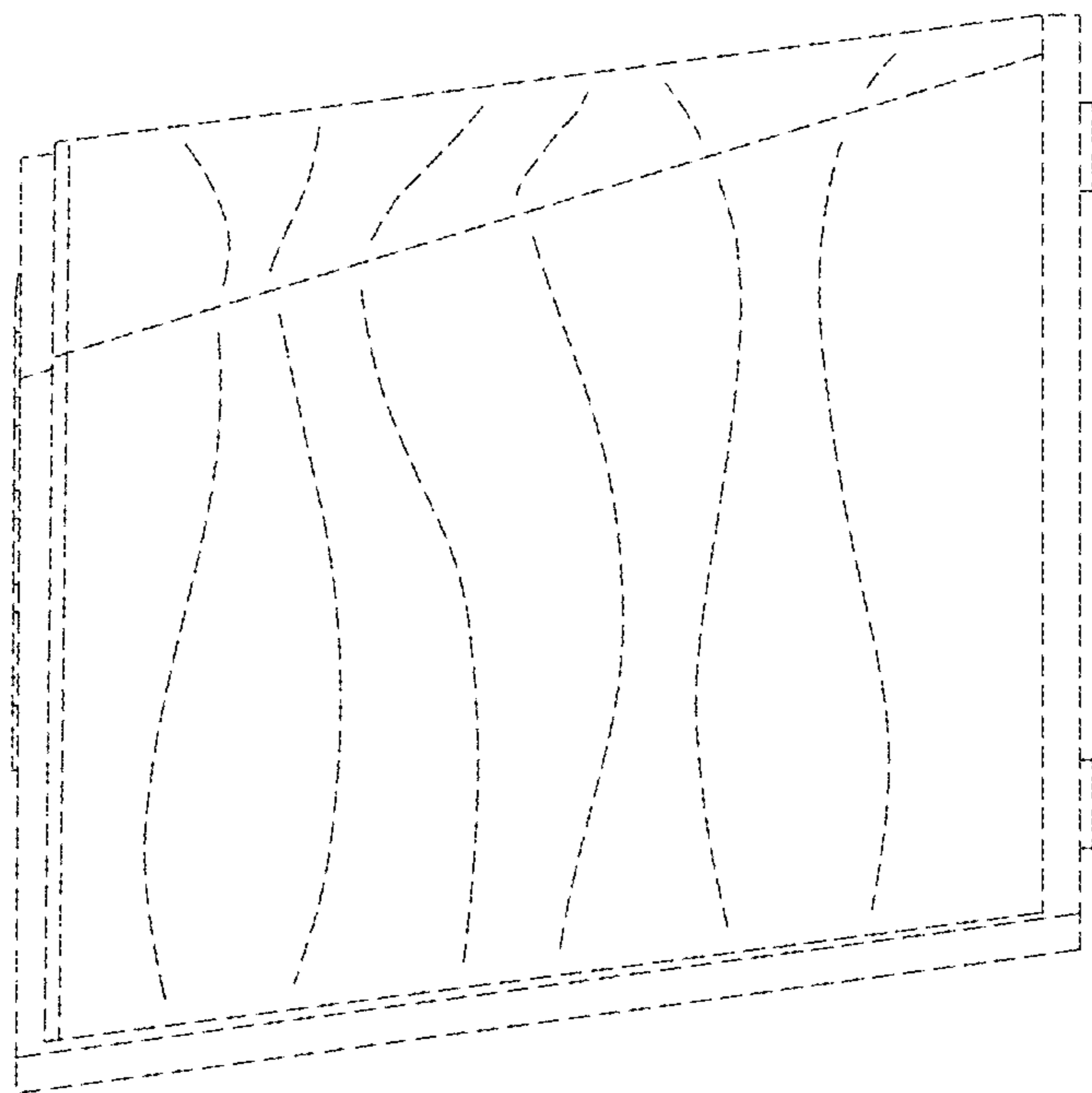

Fig. 11

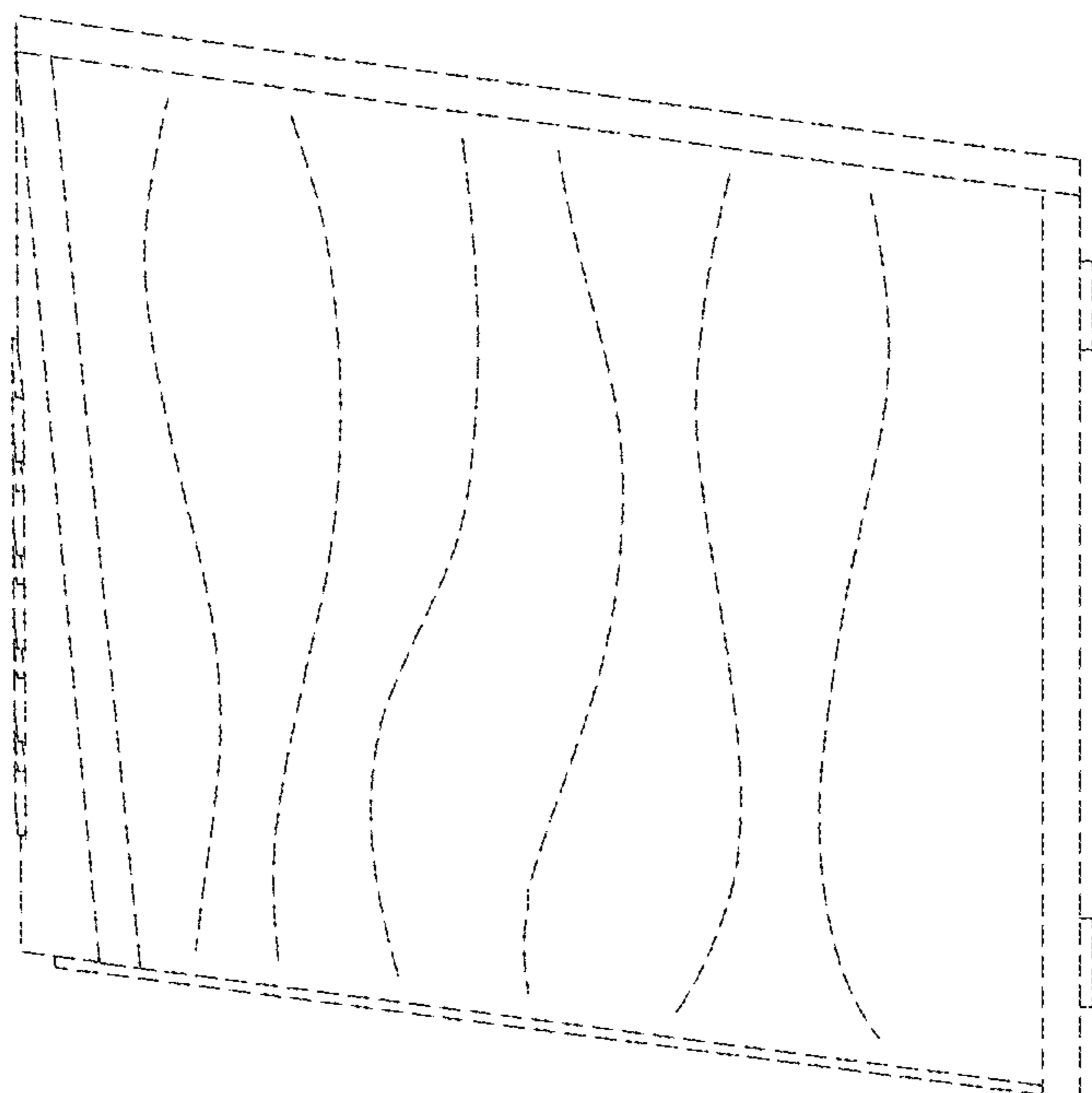

Fig. 12

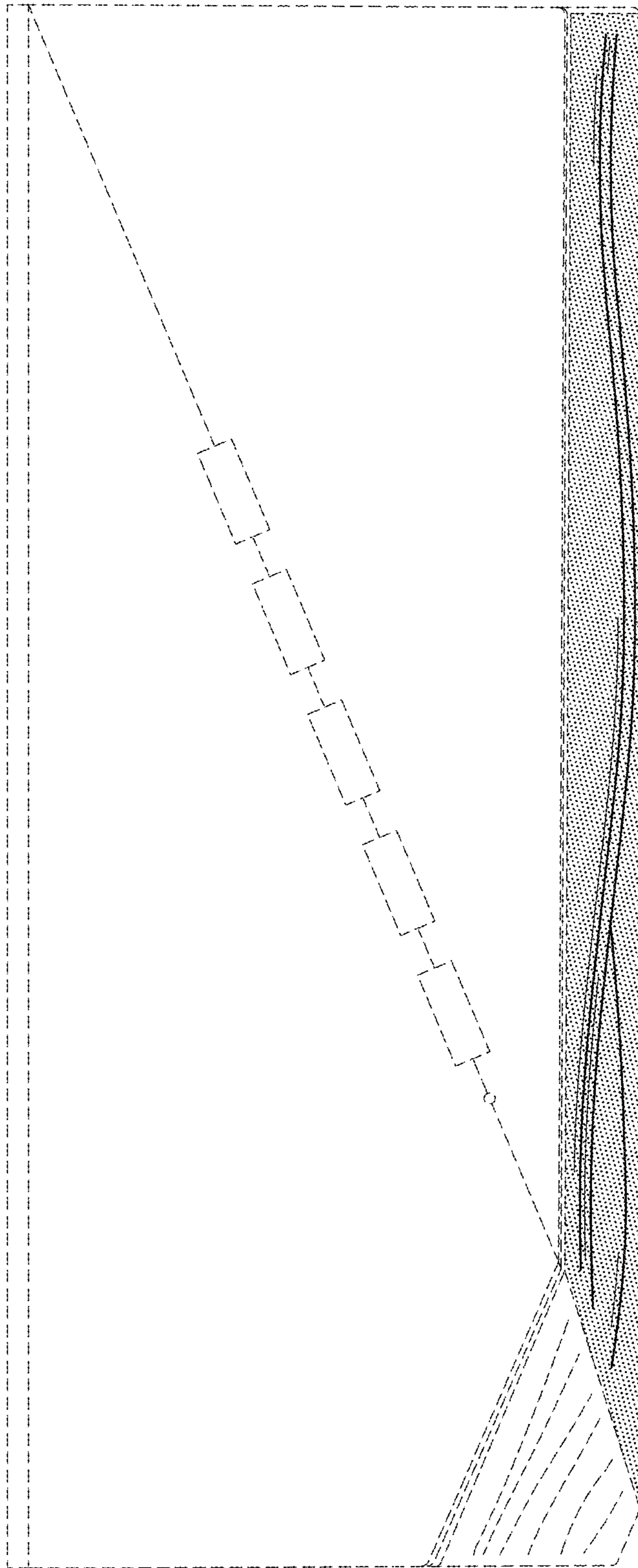

Fig. 13

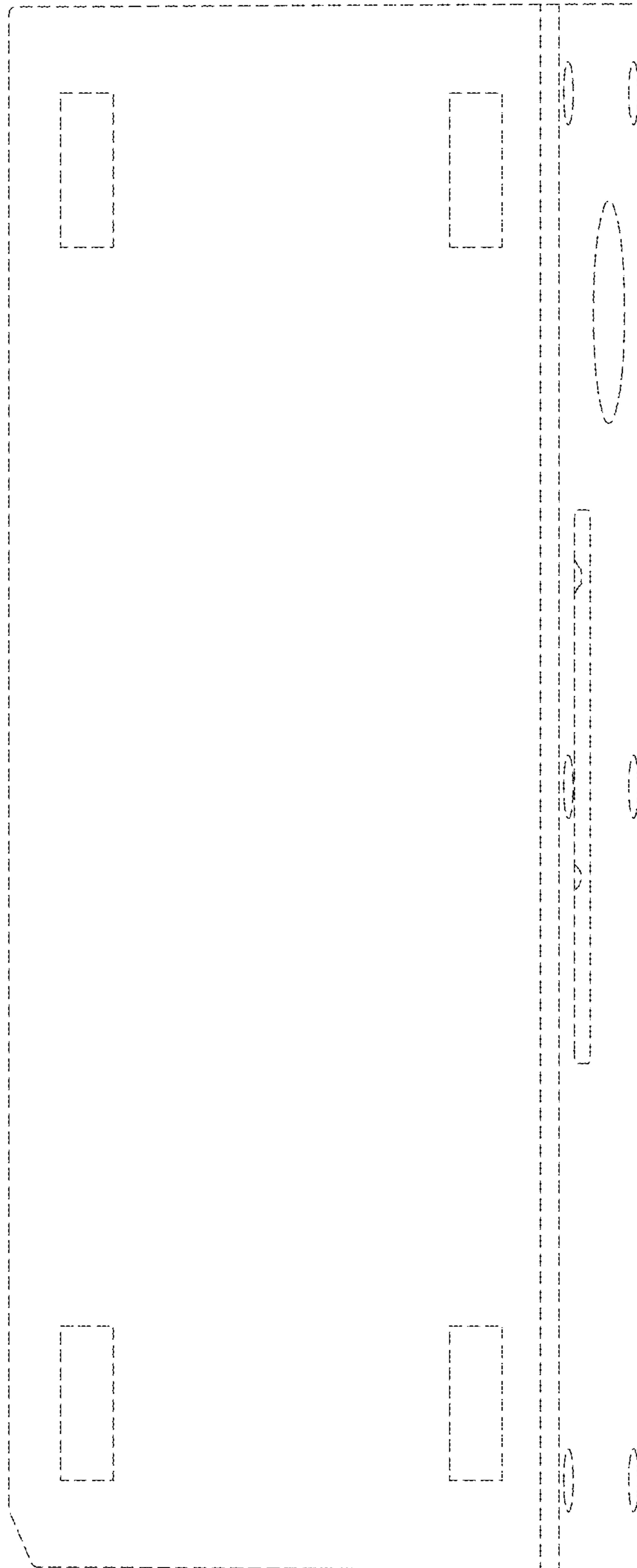

Fig. 14

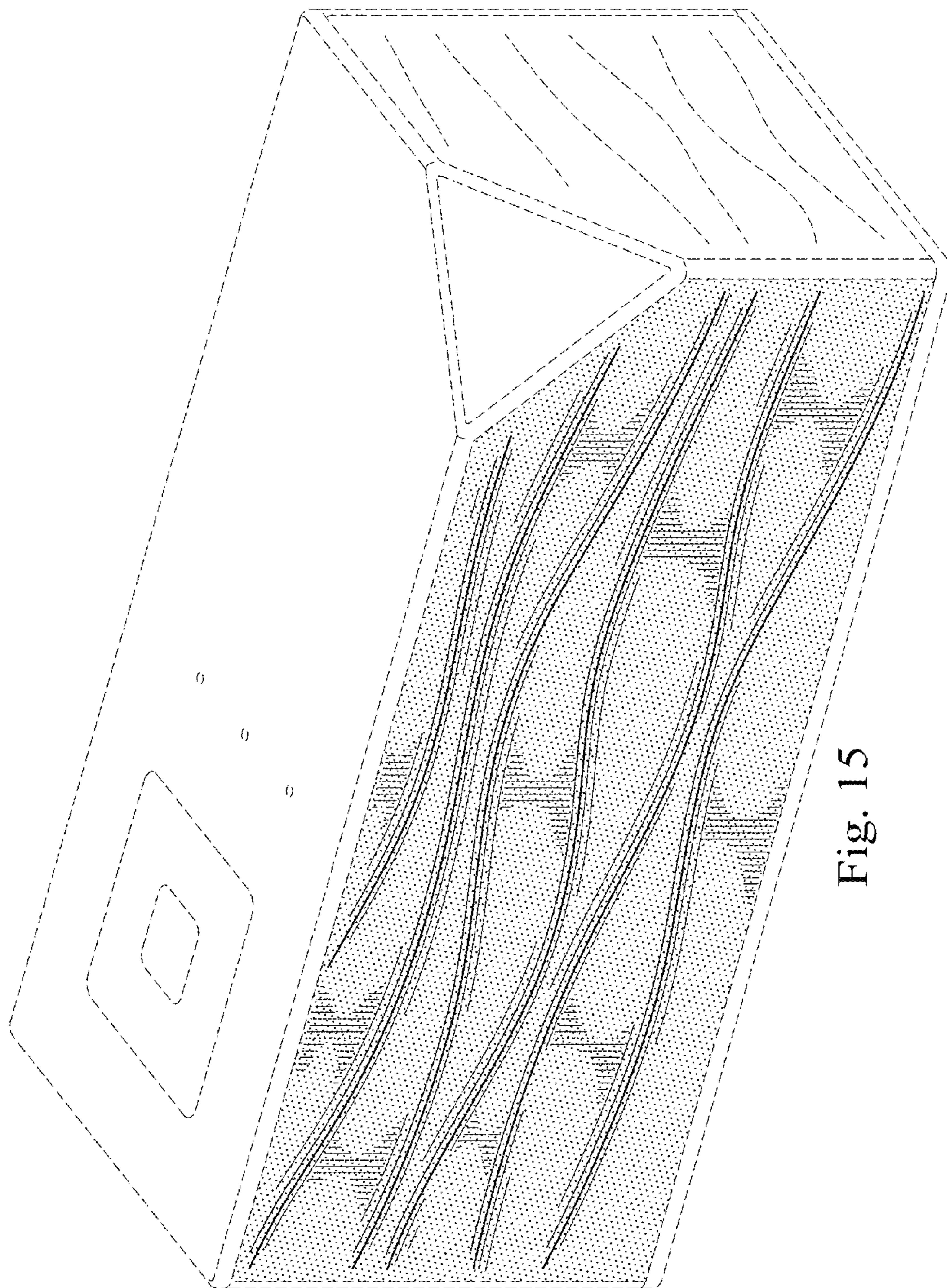

Fig. 15

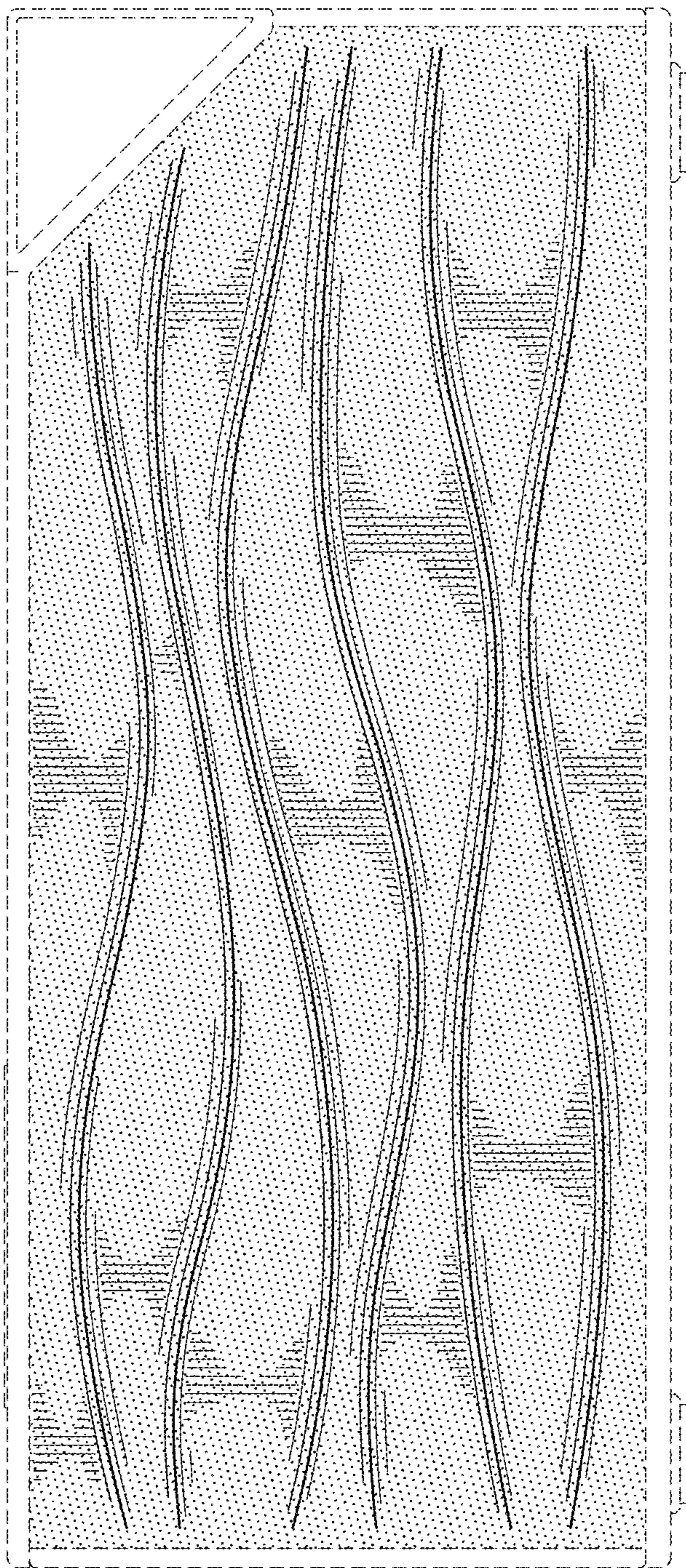

Fig. 16

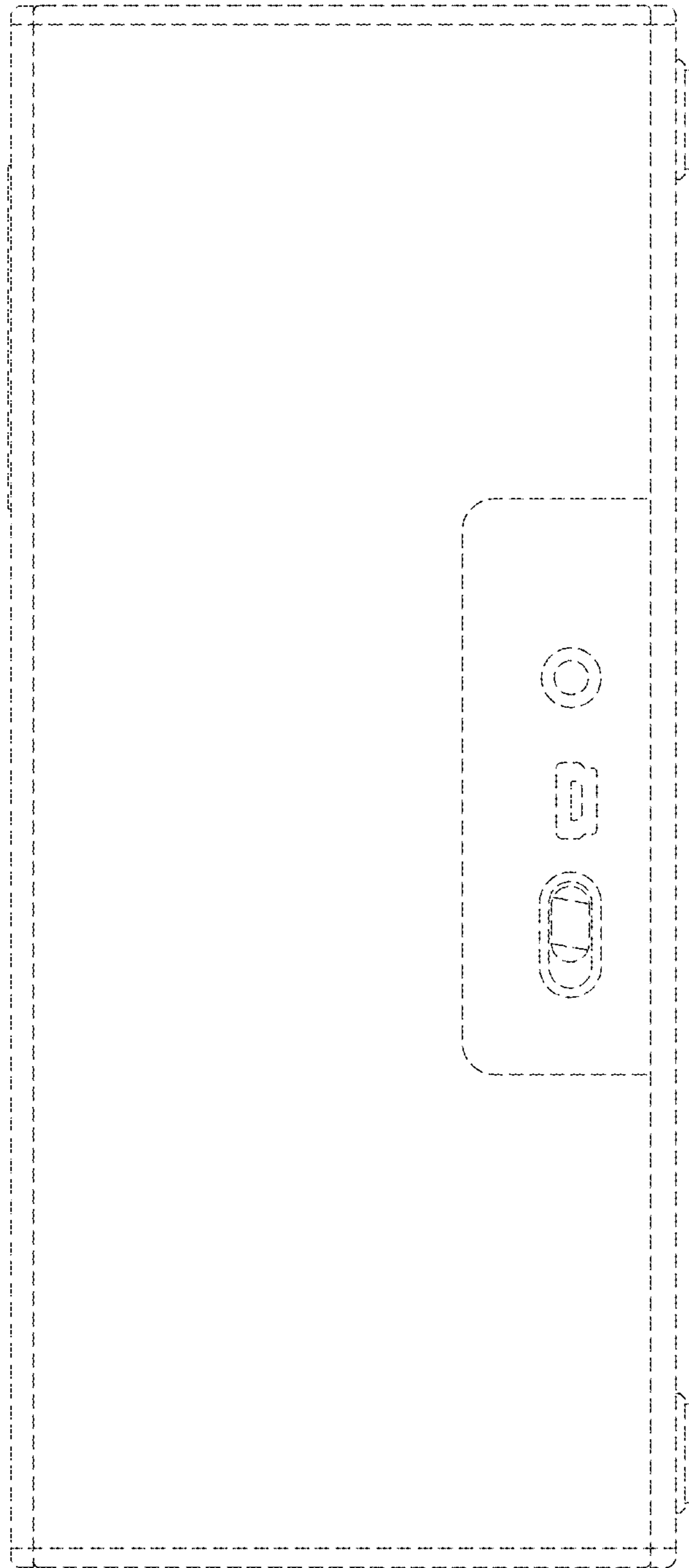

Fig. 17

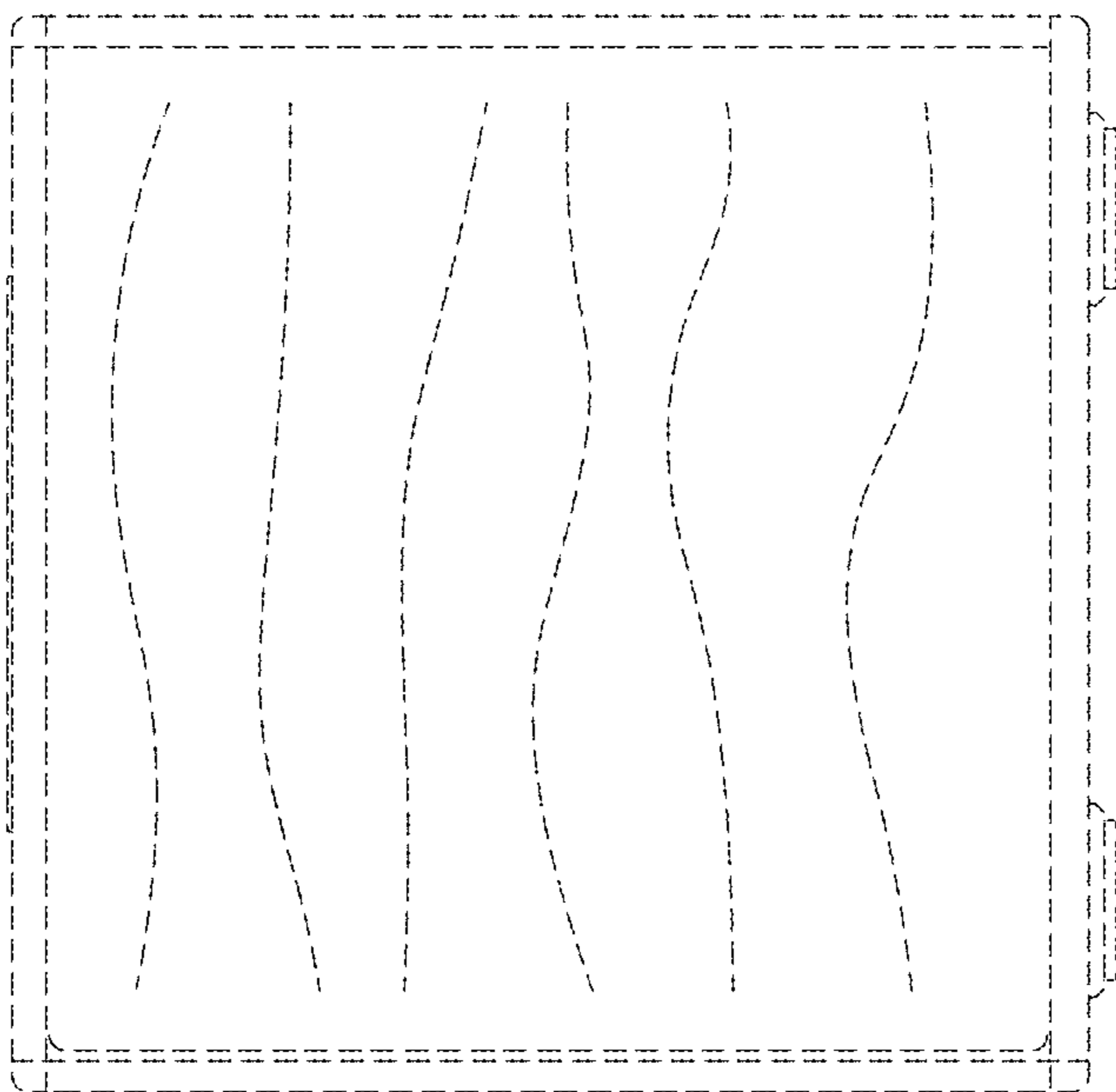

Fig. 19

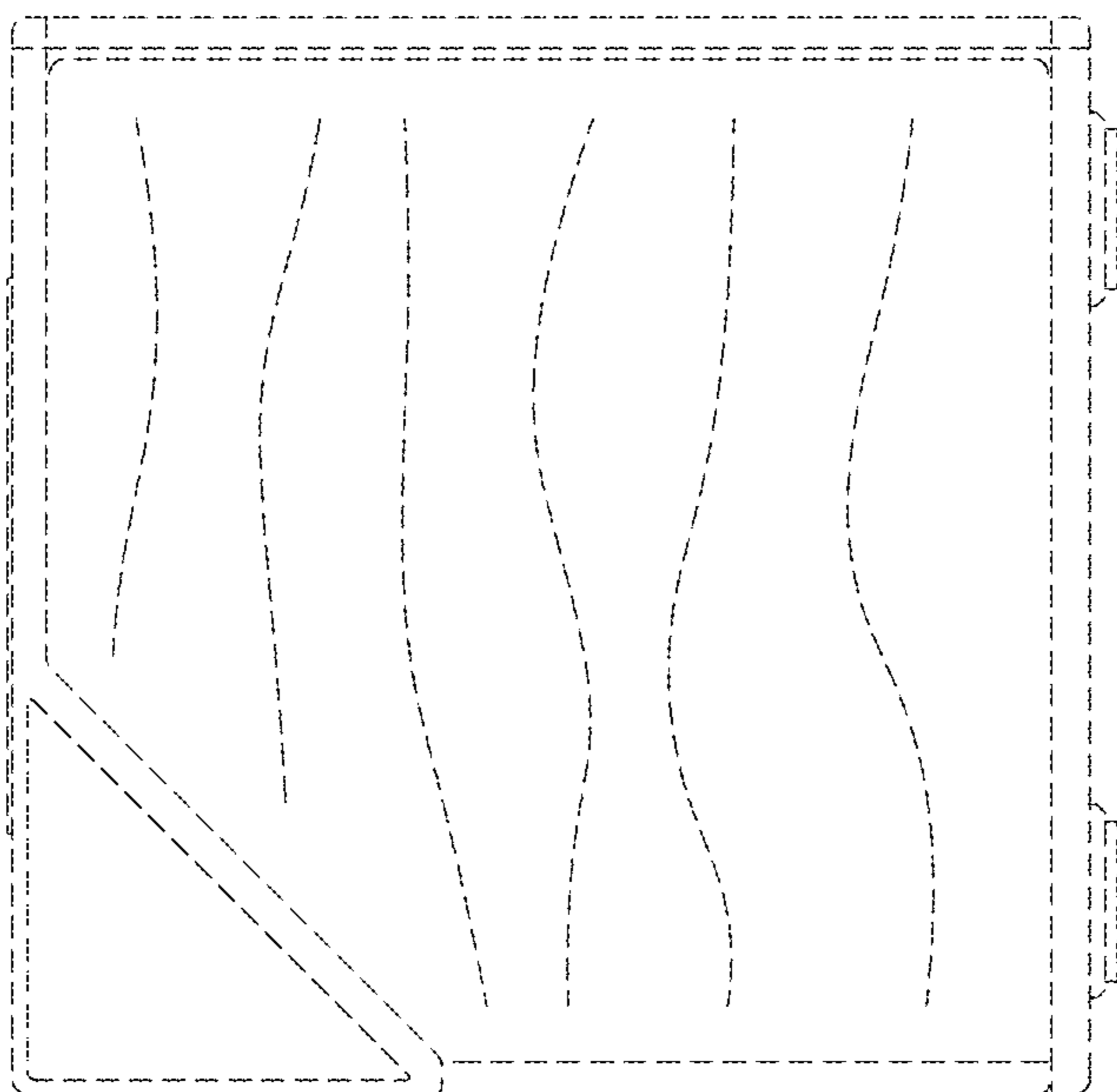

Fig. 18

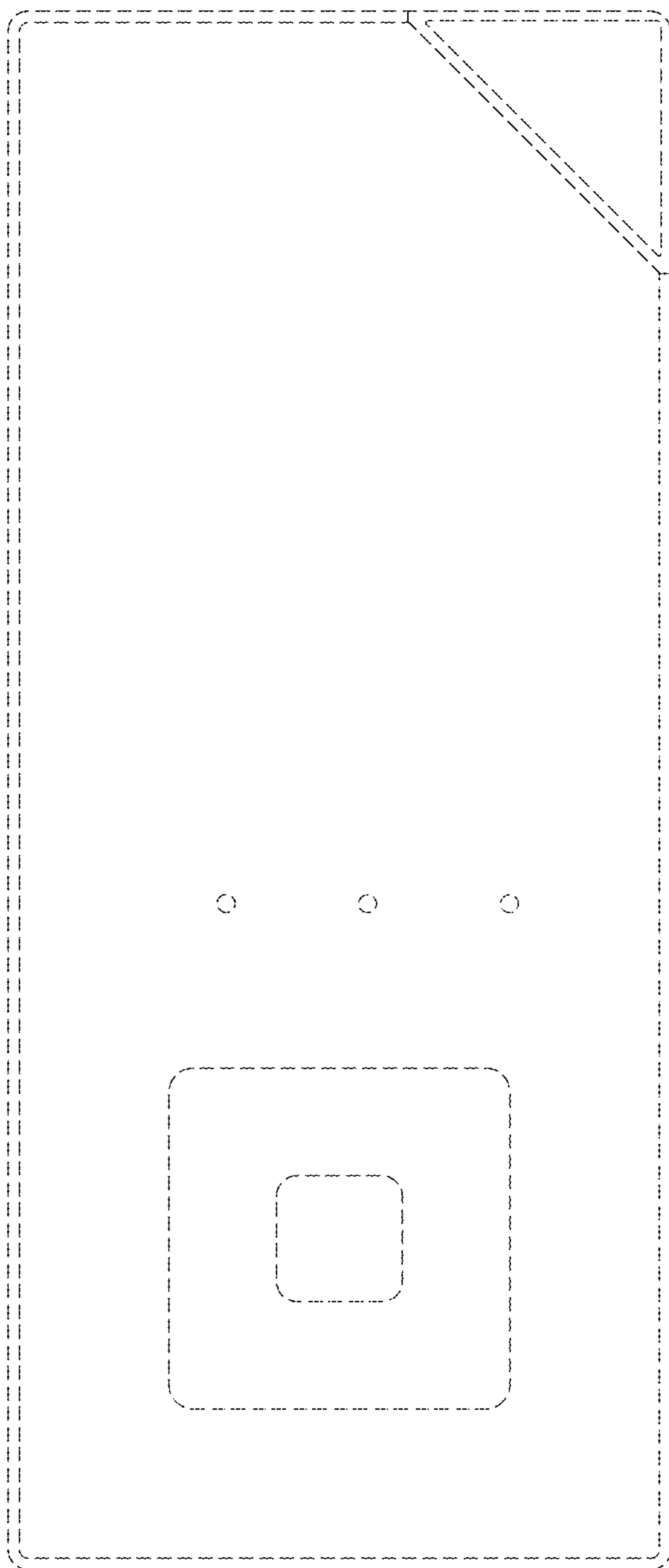

Fig. 20

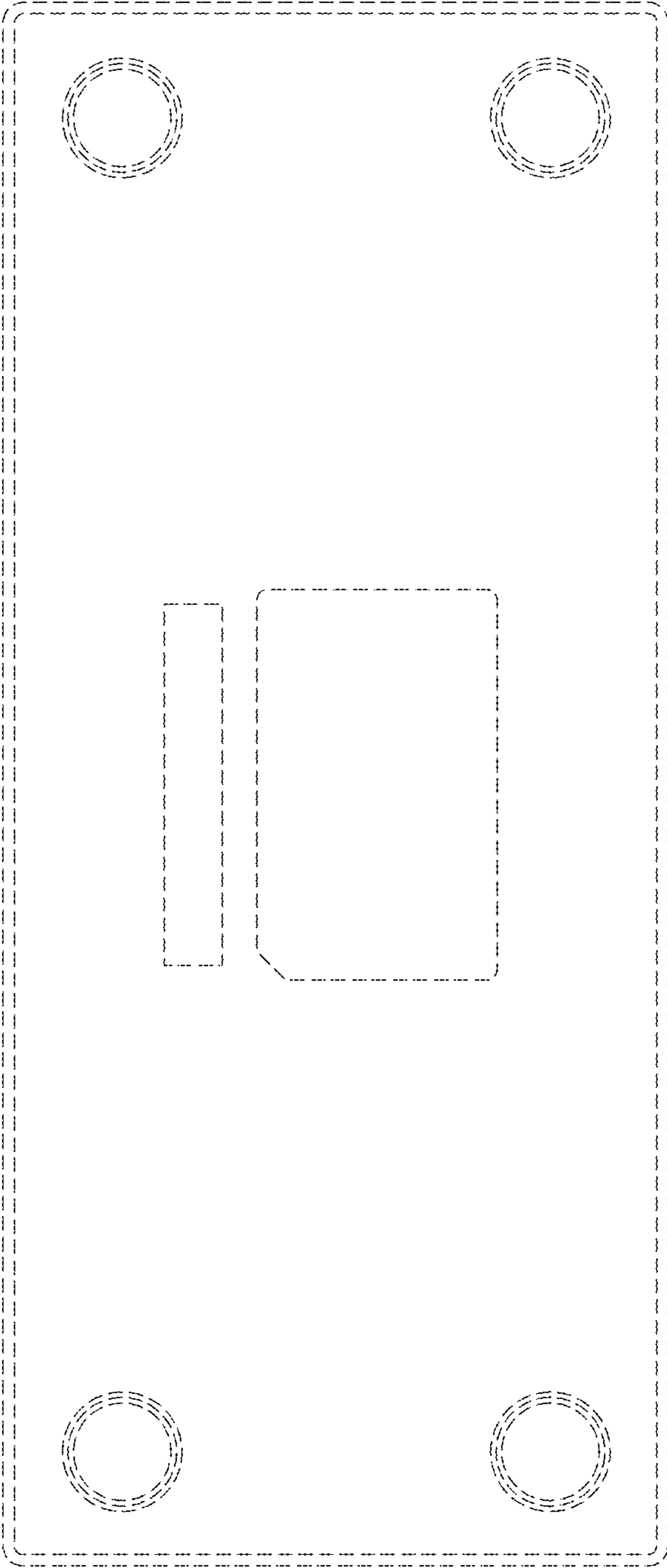

Fig. 21