



US00D739802S

(12) **United States Design Patent**
Miansian

(10) **Patent No.:** **US D739,802 S**

(45) **Date of Patent:** **** Sep. 29, 2015**

(54) **WHEEL WITH FLAME DESIGN**

(71) Applicant: **James K. Miansian**, Lake Forest, CA
(US)

(72) Inventor: **James K. Miansian**, Lake Forest, CA
(US)

(**) Term: **14 Years**

(21) Appl. No.: **29/457,199**

(22) Filed: **Jun. 7, 2013**

(51) **LOC (10) Cl.** **12-16**

(52) **U.S. Cl.**
USPC **D12/209**

(58) **Field of Classification Search**
USPC D12/204–213
CPC B60B 7/00; B60B 7/02; B60B 7/04;
B60B 7/01; B60B 7/06; B60B 3/02; B60B
3/04; B60B 3/06; B60B 3/10; B60B 1/00;
B60B 1/08; B60B 1/10; B60B 1/12
See application file for complete search history.

(56) **References Cited**

U.S. PATENT DOCUMENTS

D364,842 S	*	12/1995	Hoepfner et al.	D12/207
D366,641 S	*	1/1996	Neeper	D12/209
D384,928 S	*	10/1997	Neeper	D12/209
D385,838 S	*	11/1997	Cullen	D12/209
D435,004 S	*	12/2000	Noriega	D12/209
D491,125 S	*	6/2004	Rivers et al.	D12/209
D493,402 S	*	7/2004	Francis	D12/209
D494,915 S	*	8/2004	Wang	D12/209
D497,585 S	*	10/2004	Smith et al.	D12/209
D519,432 S	*	4/2006	Long	D12/209
D542,206 S	*	5/2007	Evans	D12/209
D556,665 S	*	12/2007	Amadio et al.	D12/209
D633,843 S	*	3/2011	Scolari et al.	D12/209

* cited by examiner

Primary Examiner — Stacia Cadmus

(74) *Attorney, Agent, or Firm* — Eric Karich; Karich & Associates

(57) **CLAIM**

The ornamental design for a “wheel with flame design,” as shown and described.

DESCRIPTION

FIG. 1 is a perspective view of a wheel with flame design, showing my new design, illustrating a wheel having a pair of decorative outer support structures and a decorative inner structure positioned between the decorative outer support structures;

FIG. 2 is a front elevational view thereof, illustrating the decorative inner structure locked in a position behind one of the decorative outer support structures;

FIG. 3 is a perspective view of one of the decorative outer support structures, the outer support structure being shown apart from the entire wheel for ease of illustration;

FIG. 4 is a perspective view of the decorative inner structure, the decorative inner structure being shown apart from the entire wheel for ease of illustration;

FIG. 5 is a left side elevational view thereof, with the right side elevational view, the top plan view, and the bottom plan view being mirror images thereof;

FIG. 6 is a rear elevational view thereof;

FIG. 7 is a front elevational view of the wheel, illustrating the decorative inner structure locked in a first position with respect to the decorative outer support structures;

FIG. 8 is a front elevational view of the wheel, illustrating the decorative inner structure locked in a second position with respect to the decorative outer support structures;

FIG. 9 is a front elevational view of the wheel, illustrating the decorative inner structure locked in a third position with respect to the decorative outer support structures;

FIG. 10 is a front elevational view of the wheel, illustrating the decorative inner structure locked in a fourth position with respect to the decorative outer support structures;

FIG. 11 is a front elevational view of the wheel, illustrating the decorative inner structure locked in a fifth position with respect to the decorative outer support structures;

FIG. 12 is a front elevational view of the wheel, illustrating the decorative inner structure locked in a sixth position with respect to the decorative outer support structures;

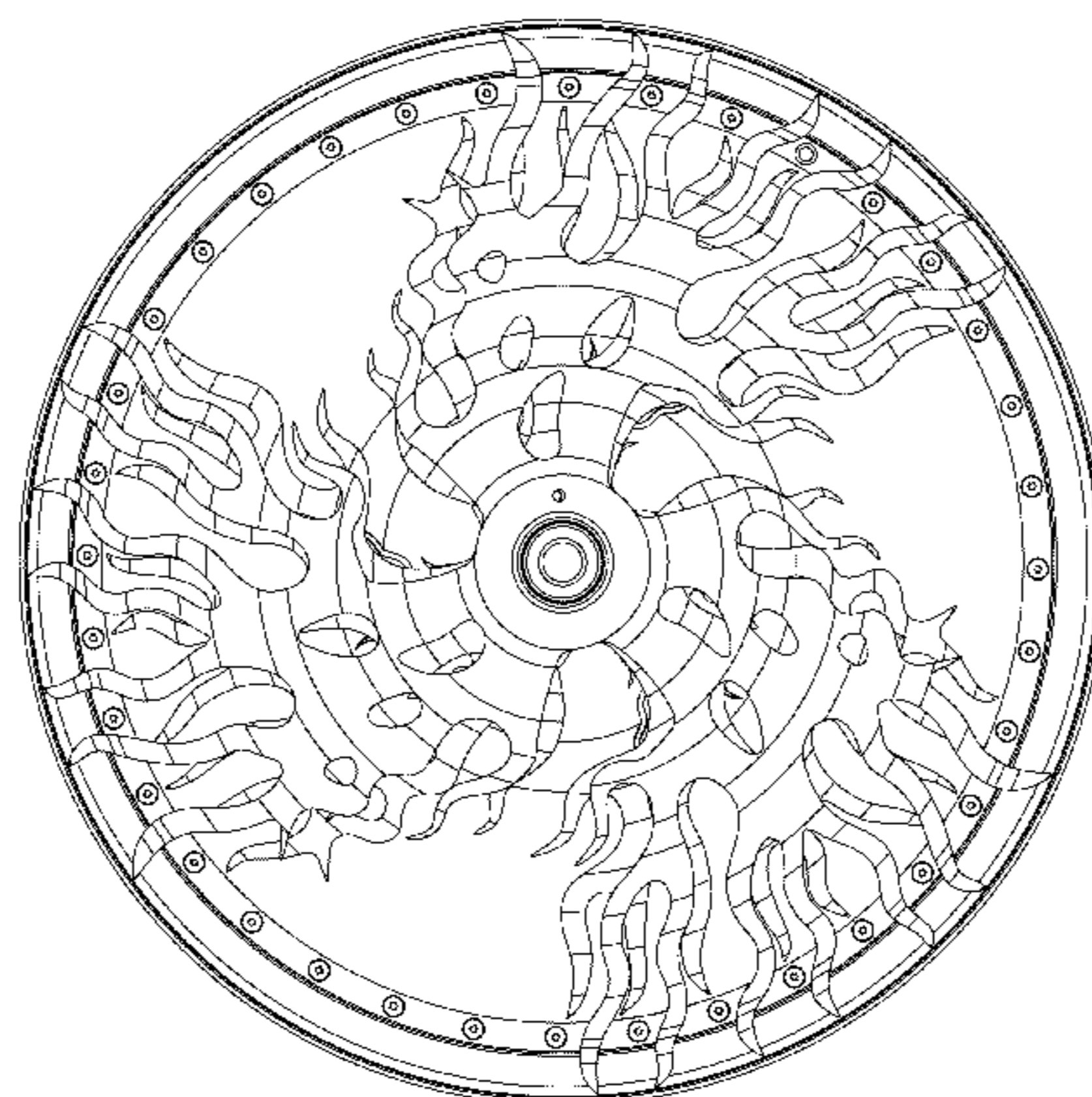

FIG. 13 is a front elevational view of the wheel, illustrating the decorative inner structure locked in a seventh position with respect to the decorative outer support structures;
FIG. 14 is a front elevational view of the wheel, illustrating the decorative inner structure locked in an eighth position with respect to the decorative outer support structures;
FIG. 15 is a front elevational view of the wheel, illustrating the decorative inner structure locked in a ninth position with respect to the decorative outer support structures;
FIG. 16 is a front elevational view of the wheel, illustrating the decorative inner structure locked in a tenth position with respect to the decorative outer support structures;
FIG. 17 is a front elevational view of the wheel, illustrating the decorative inner structure locked in an eleventh position with respect to the decorative outer support structures;
FIG. 18 is a front elevational view of the wheel, illustrating the decorative inner structure locked in a twelfth position with respect to the decorative outer support structures;

FIG. 19 is a front elevational view of the wheel, illustrating the decorative inner structure locked in a thirteenth position with respect to the decorative outer support structures;
FIG. 20 is a front elevational view of the wheel, illustrating the decorative inner structure locked in a fourteenth position with respect to the decorative outer support structures; and,
FIG. 21 is a front elevational view of the wheel, illustrating the decorative inner structure locked in a fifteenth position with respect to the decorative outer support structures.
As illustrated in FIGS. 1-21, by locking the decorative inner structure in different positions relative to the decorative outer support structures, a different ornamental appearance is achieved.

1 Claim, 21 Drawing Sheets

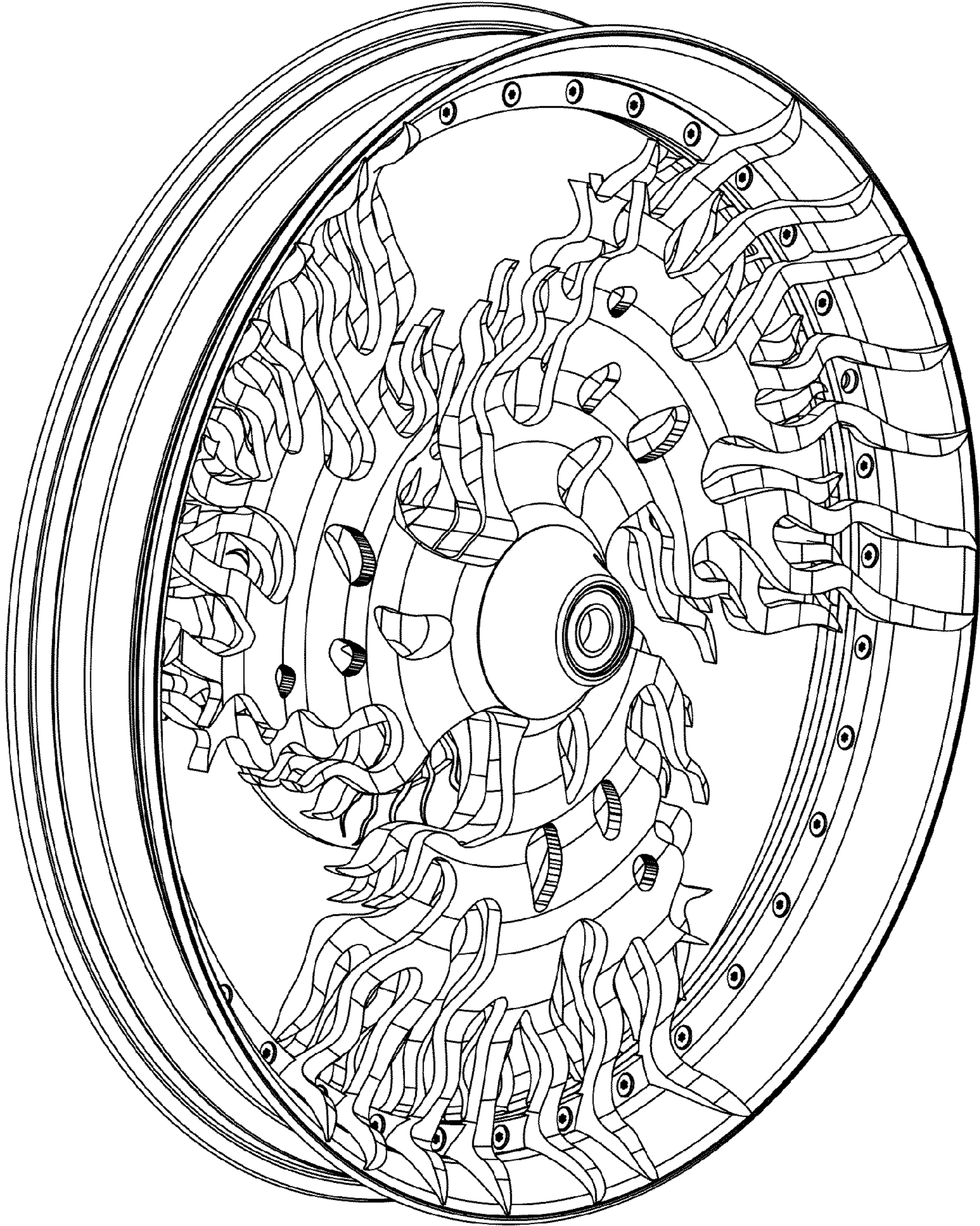

Fig. 1

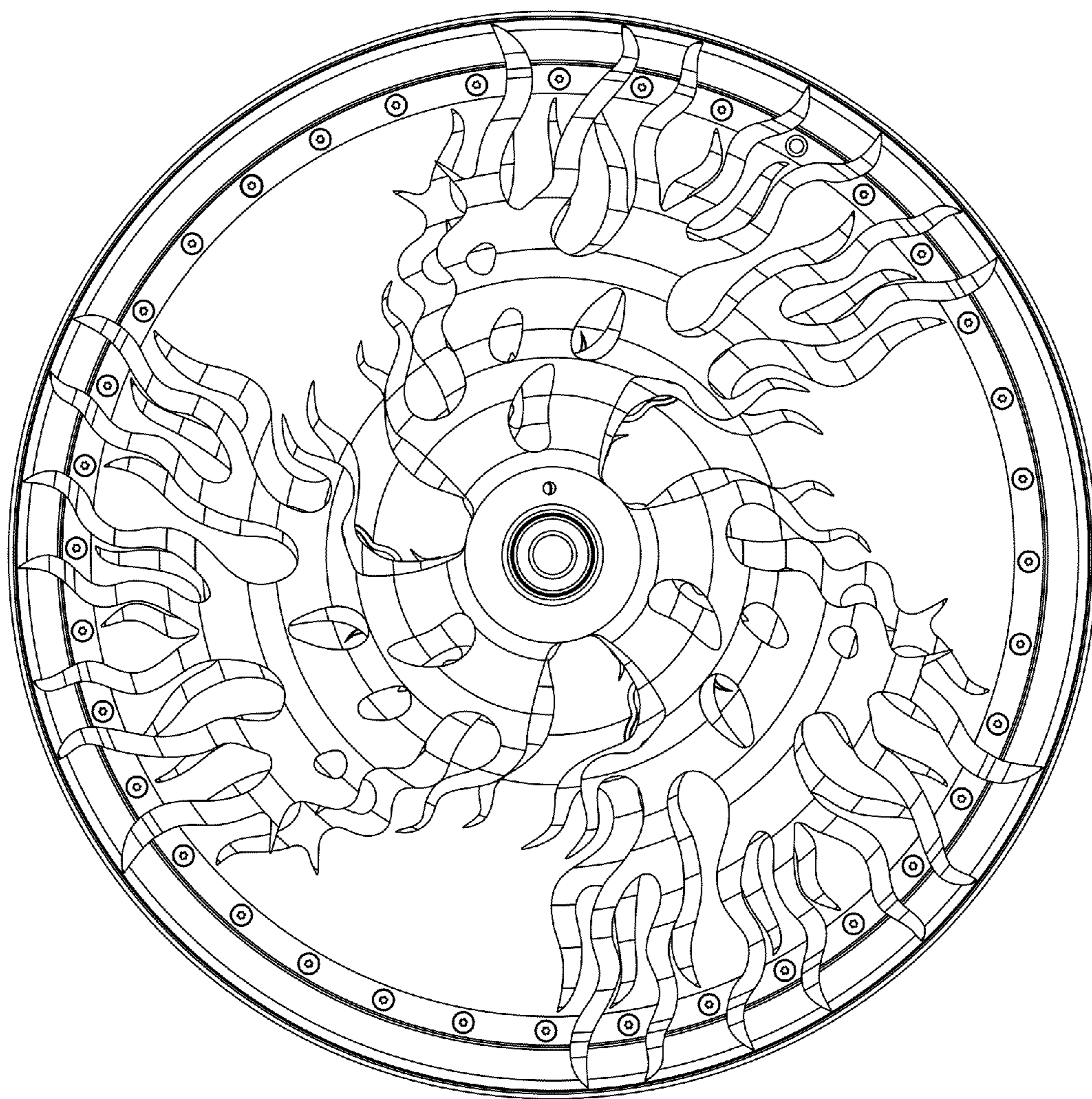

Fig. 2

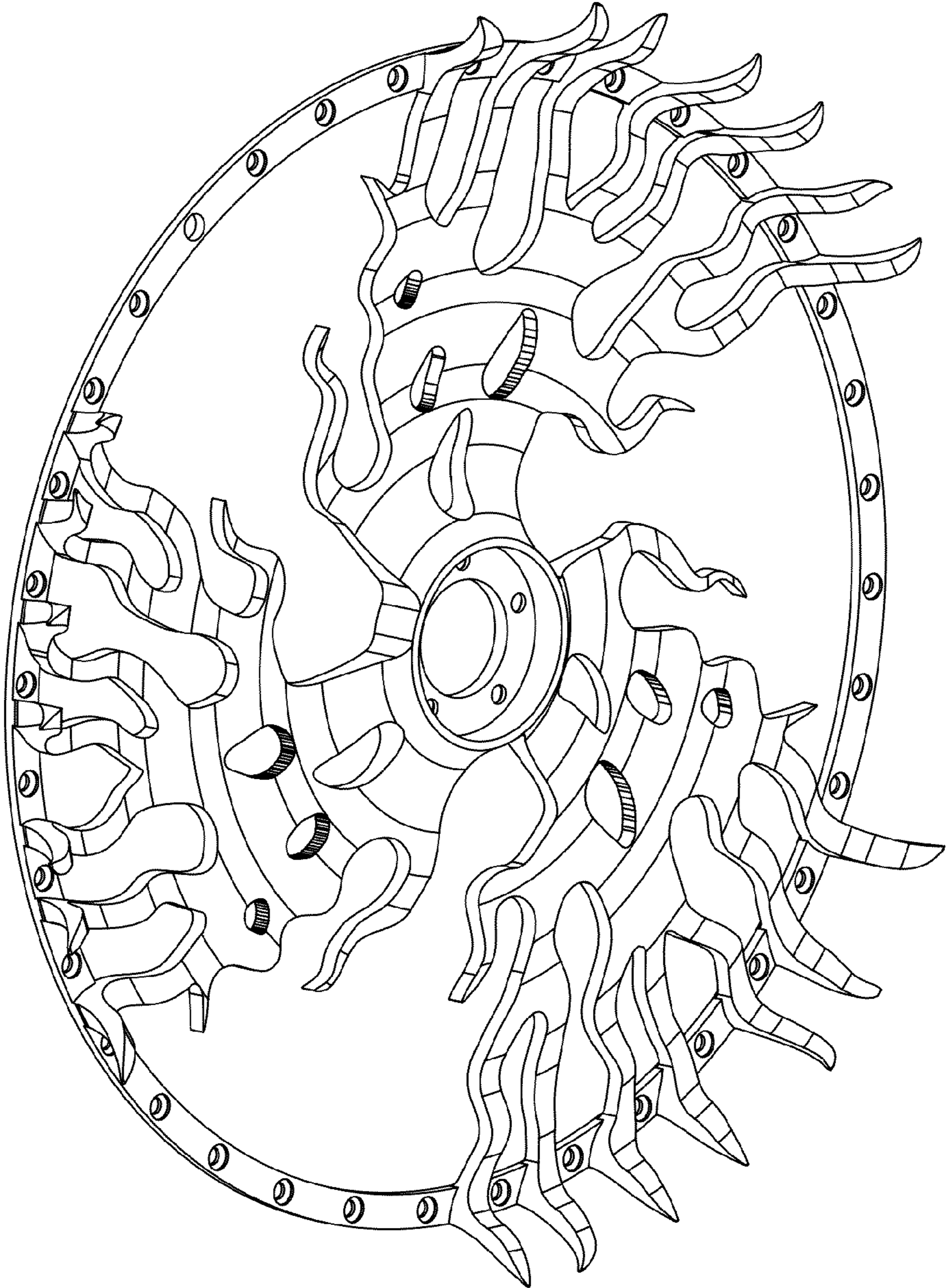

Fig. 3

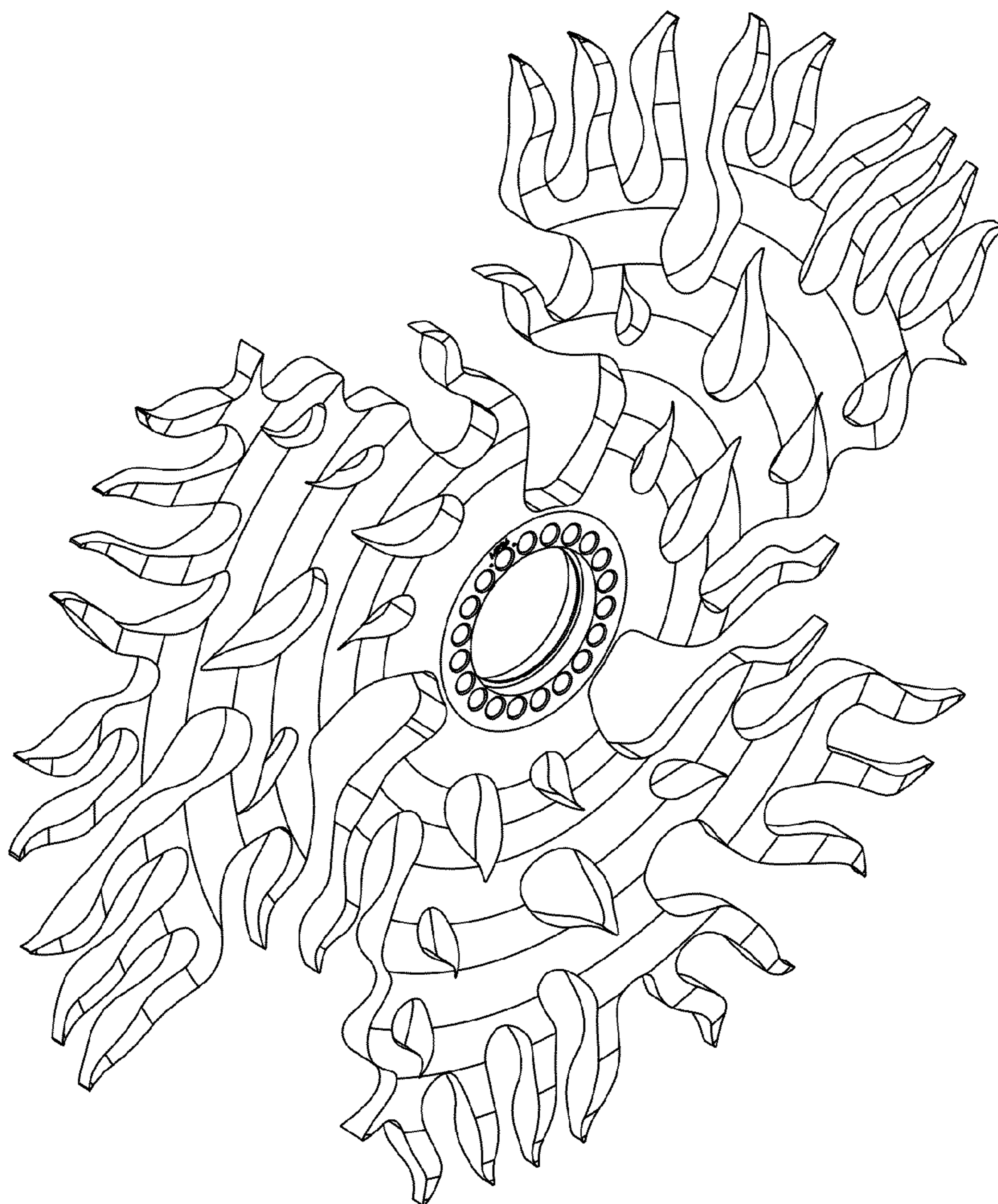

Fig. 4

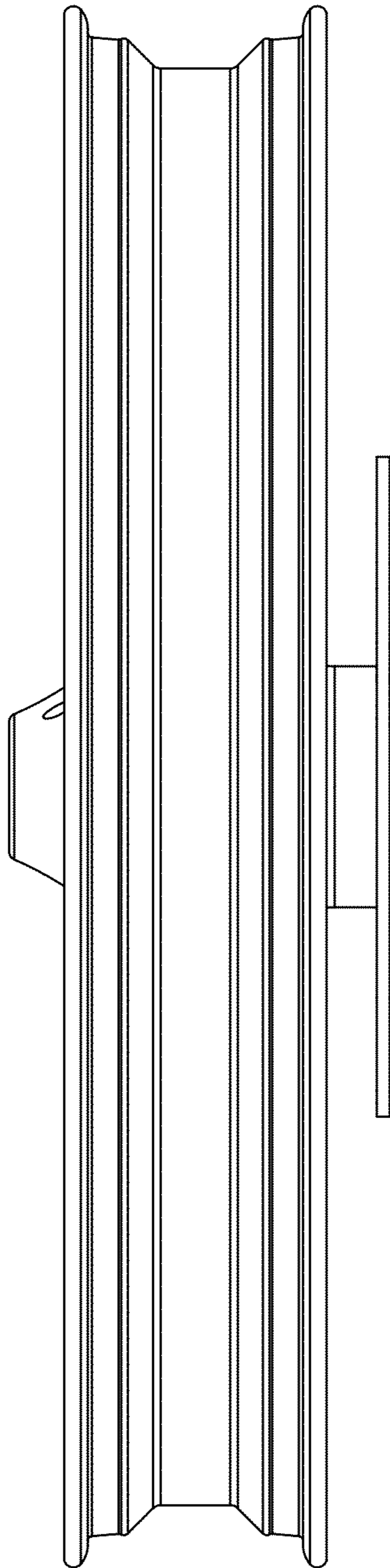

Fig. 5

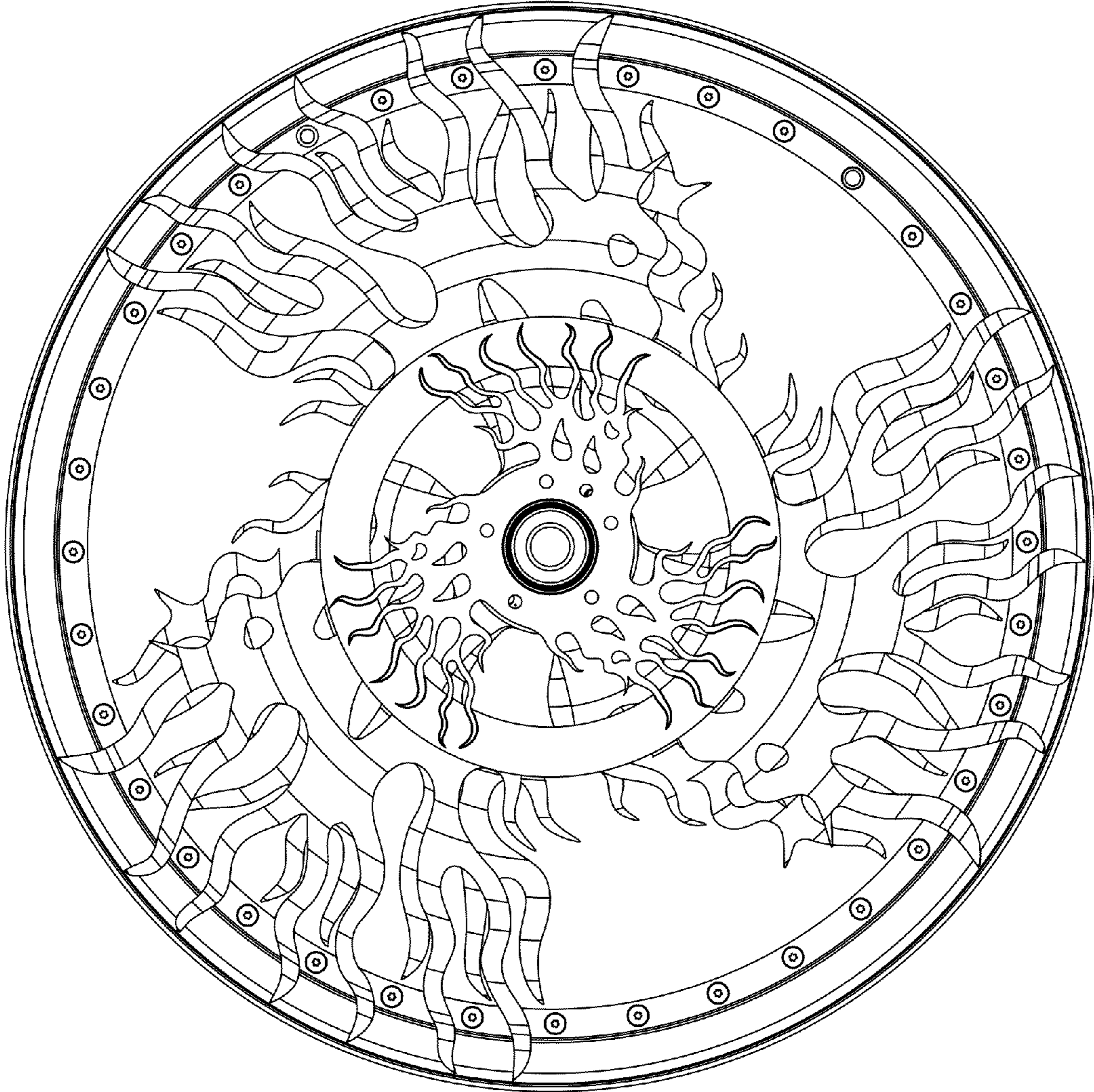

Fig. 6

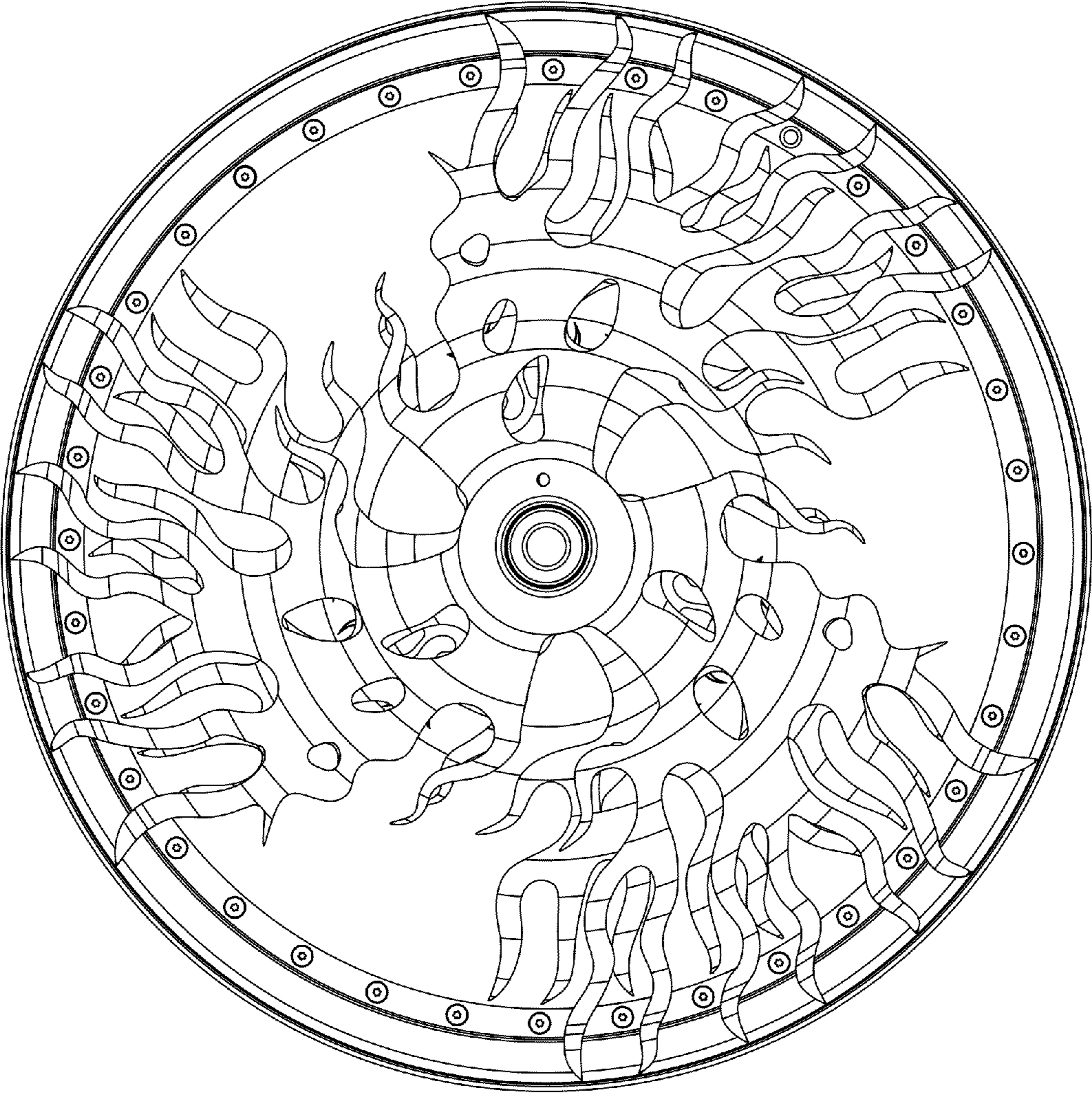

Fig. 7

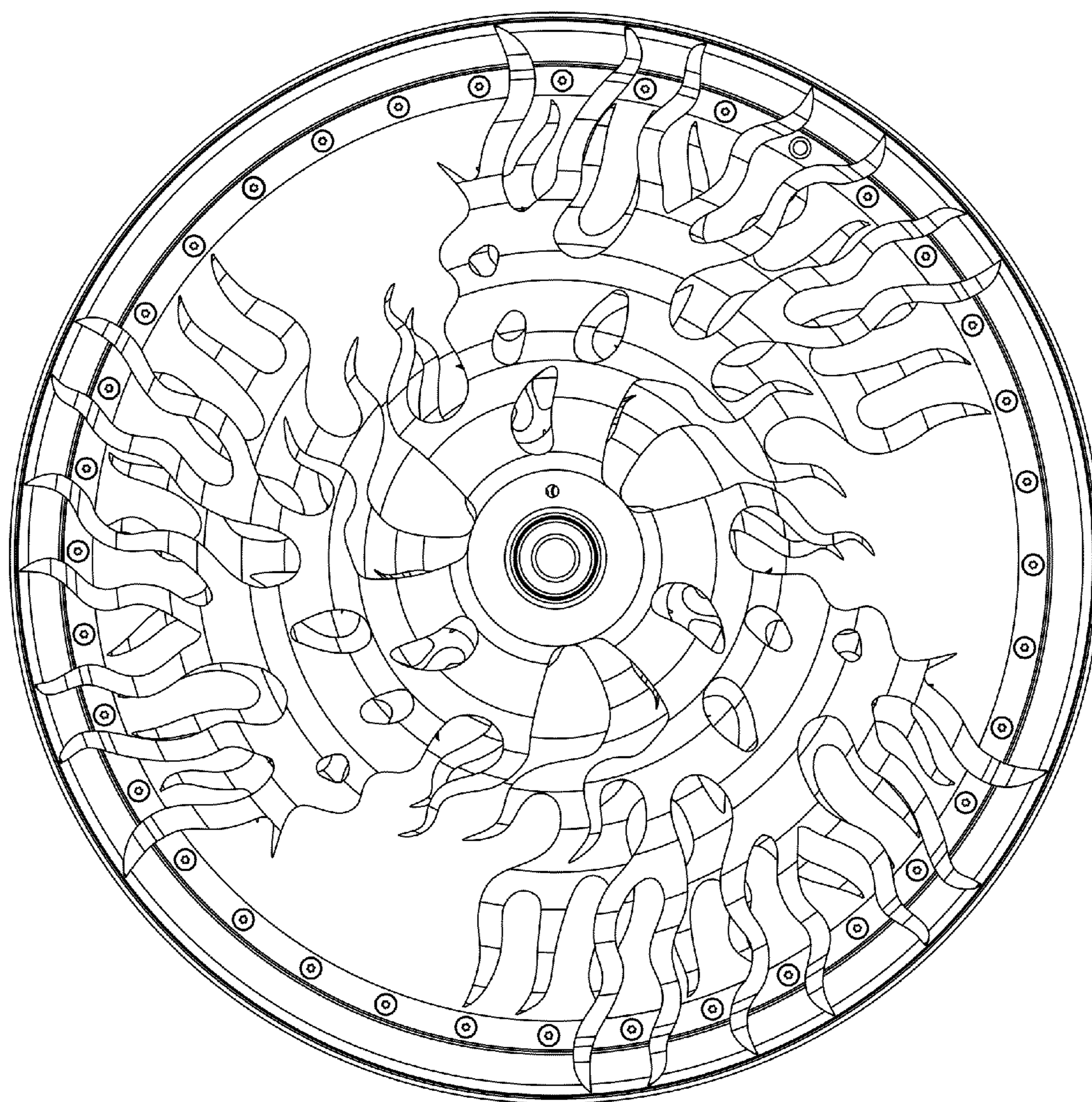

Fig. 8

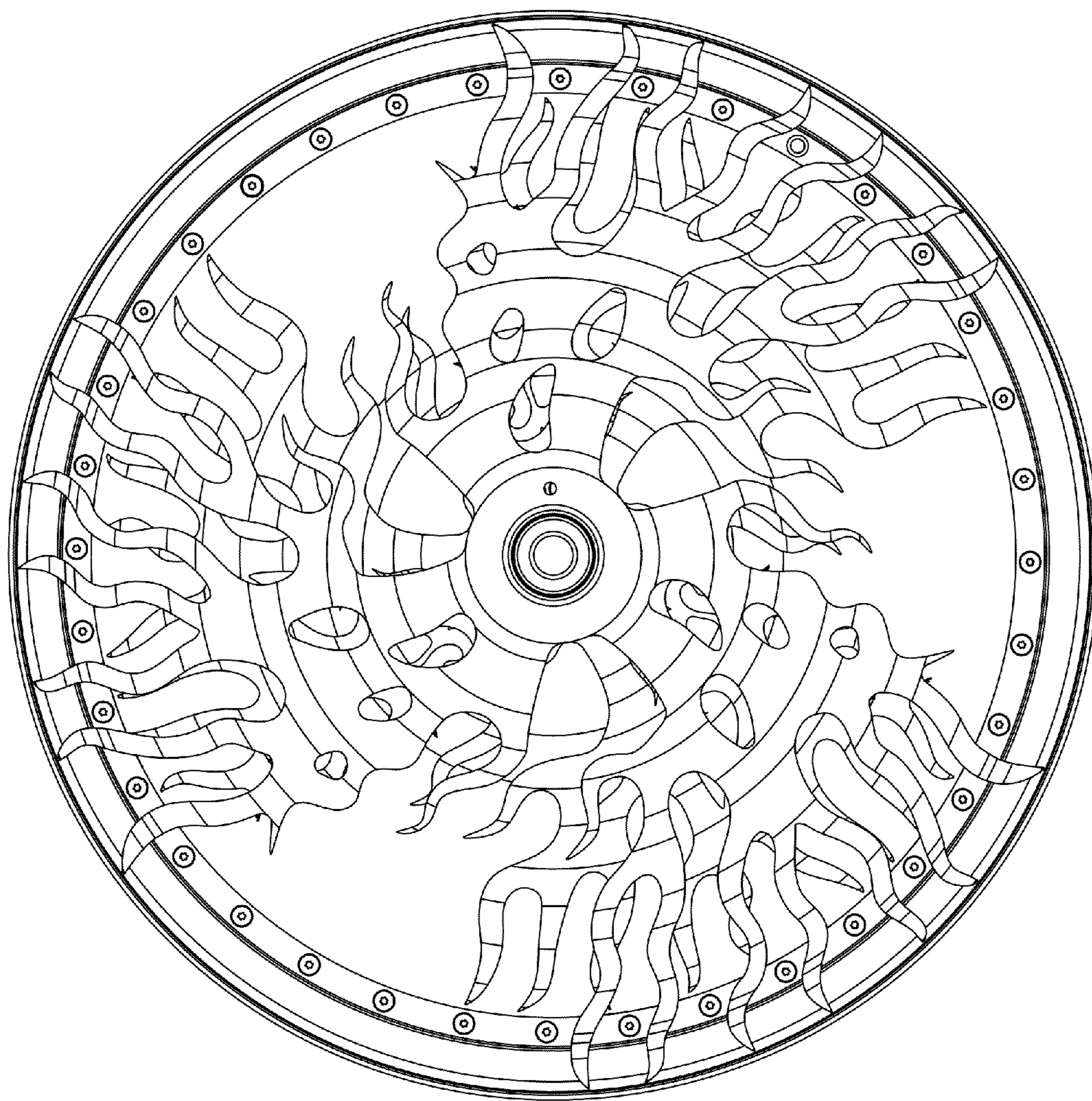

Fig. 9

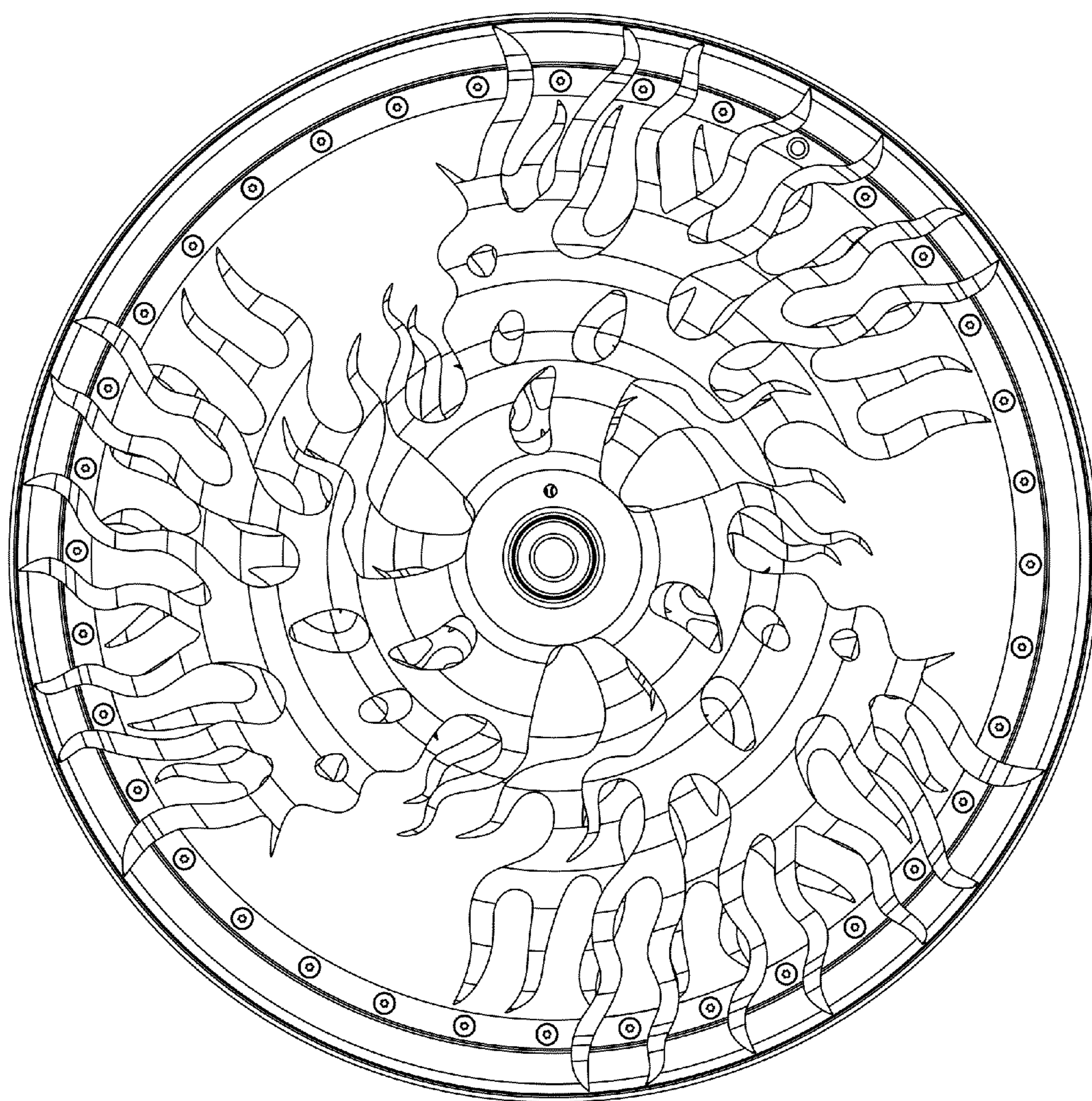

Fig. 10

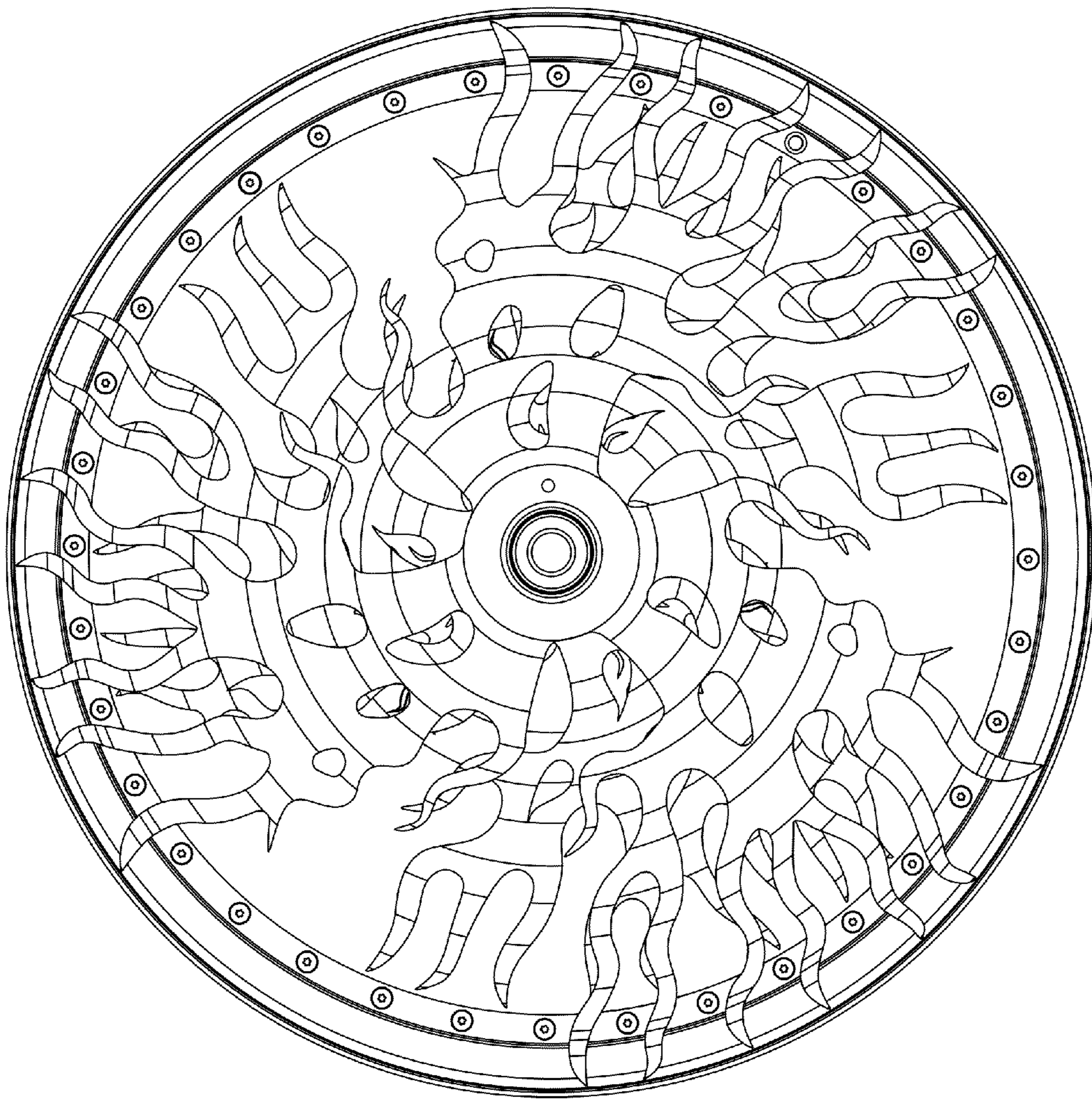

Fig. 11

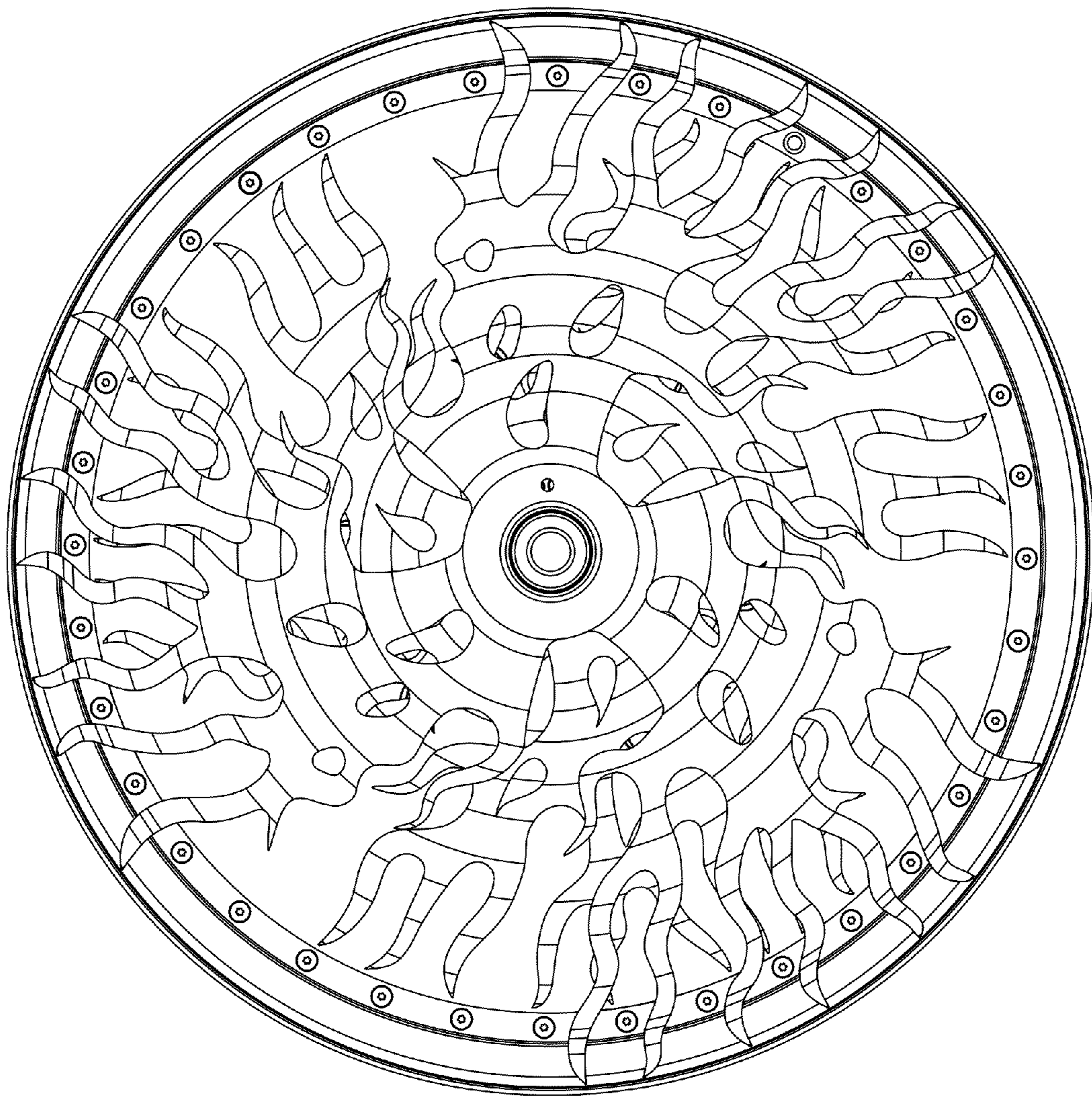

Fig. 12

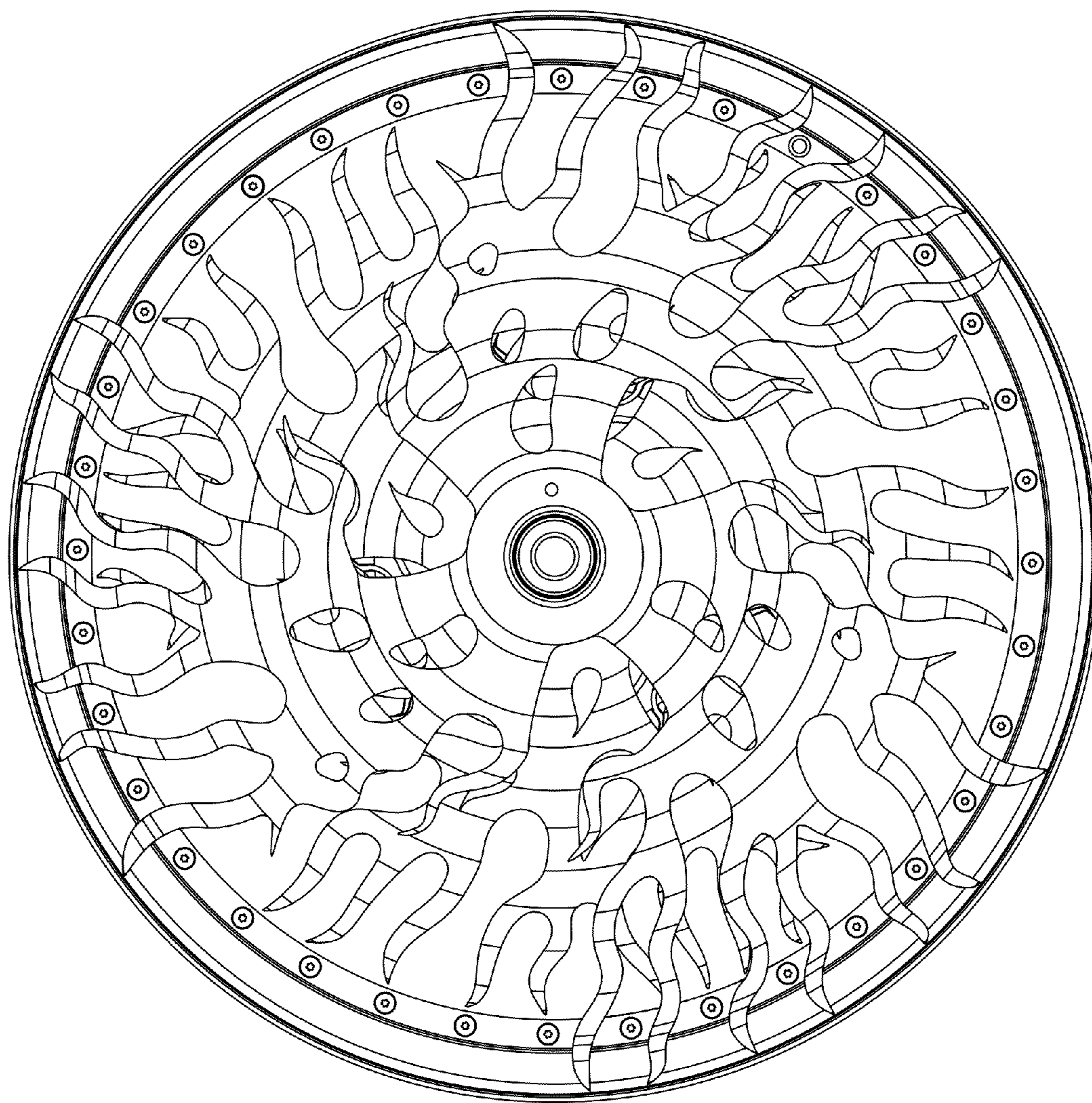

Fig. 13

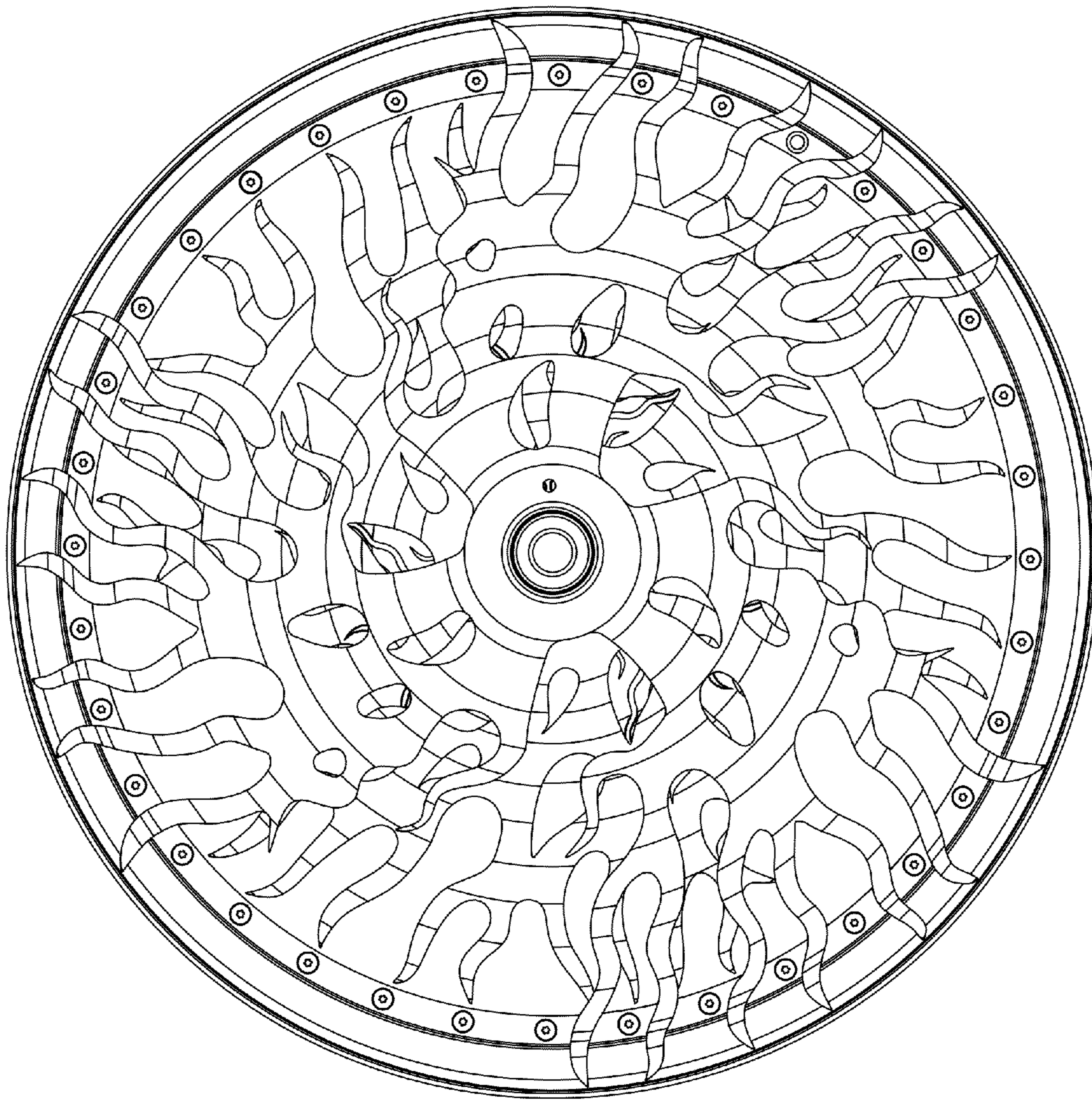

Fig. 14

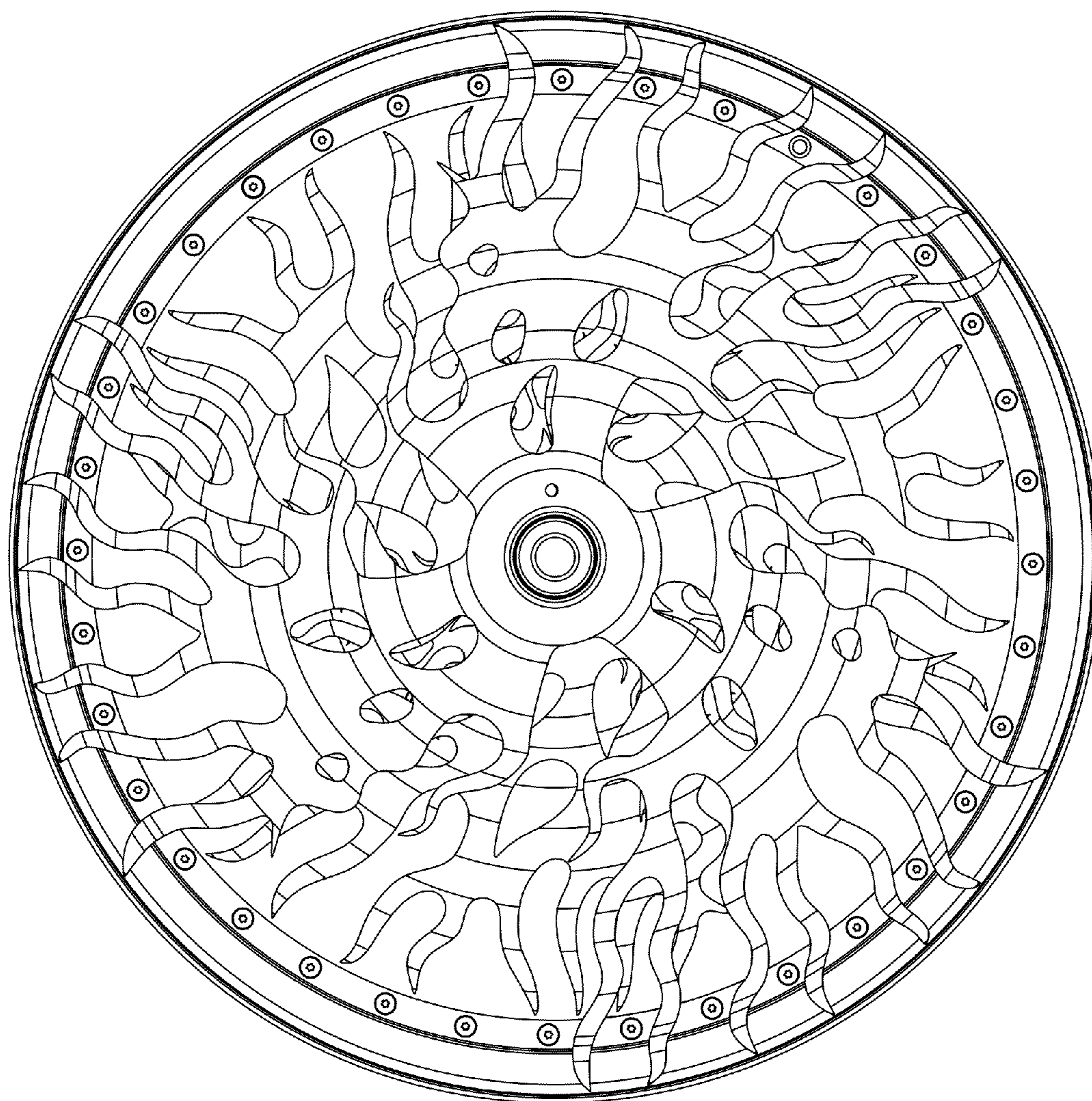

Fig. 15

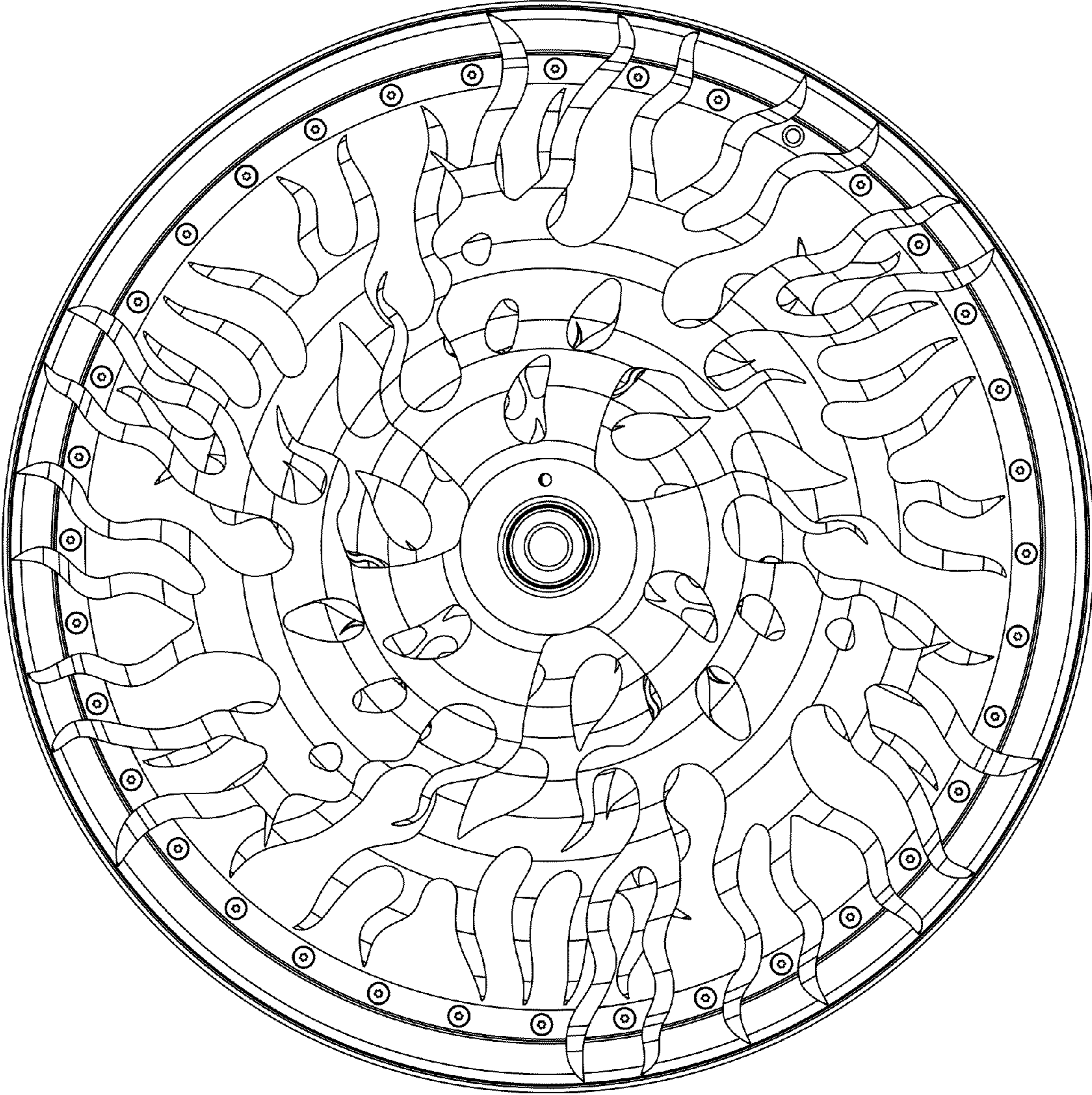

Fig. 16

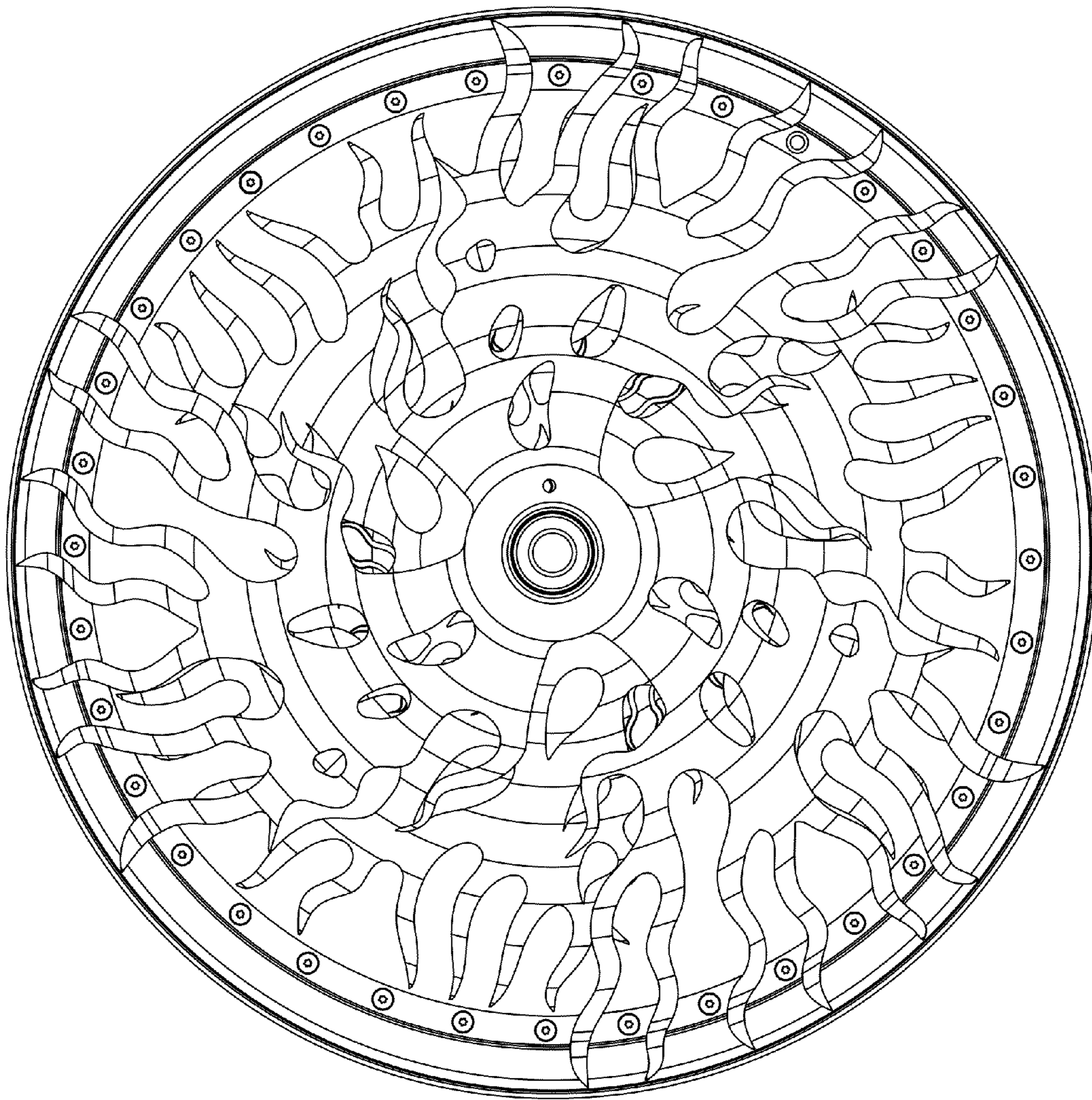

Fig. 17

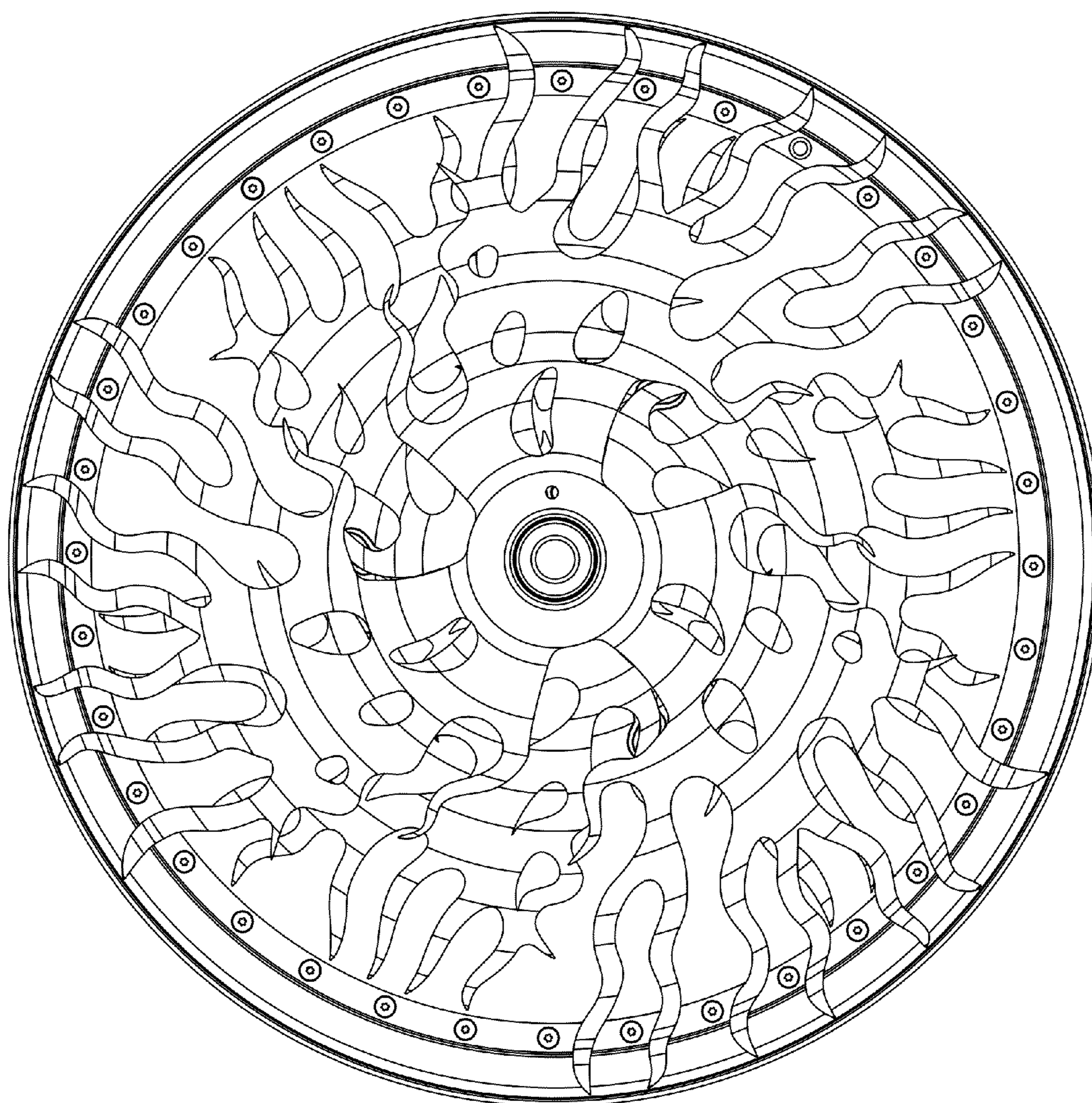

Fig. 18

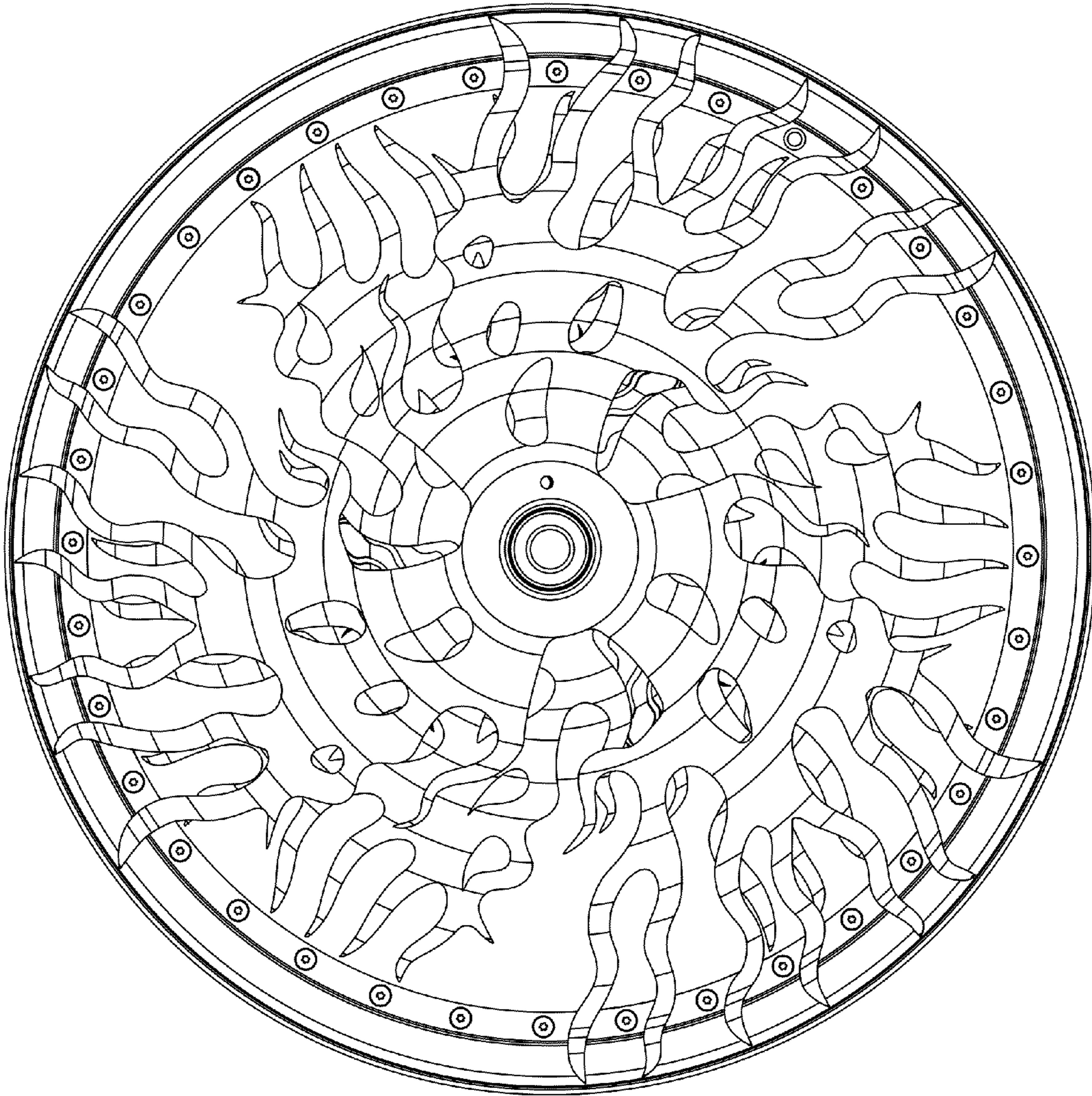

Fig. 19

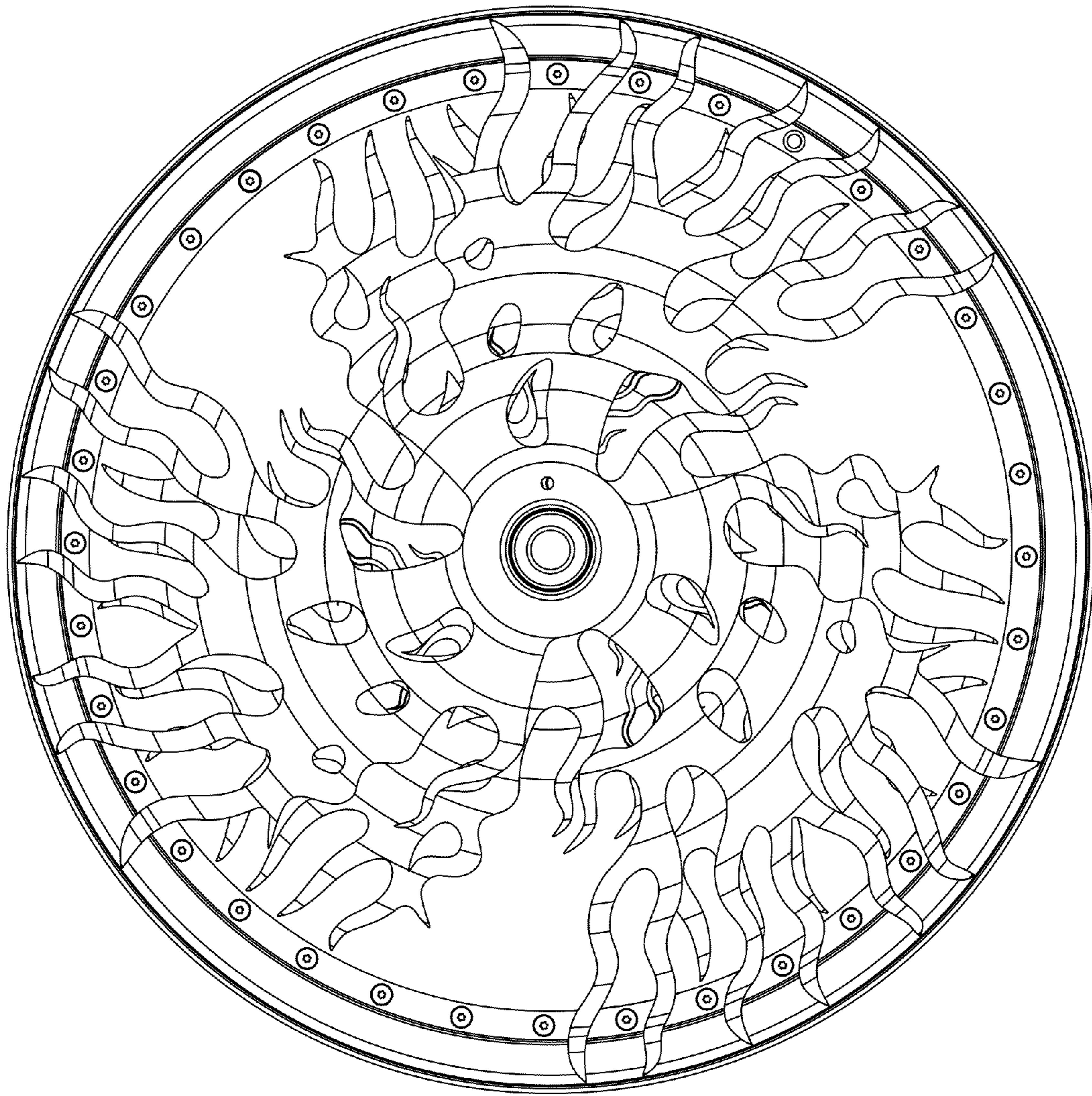

Fig. 20

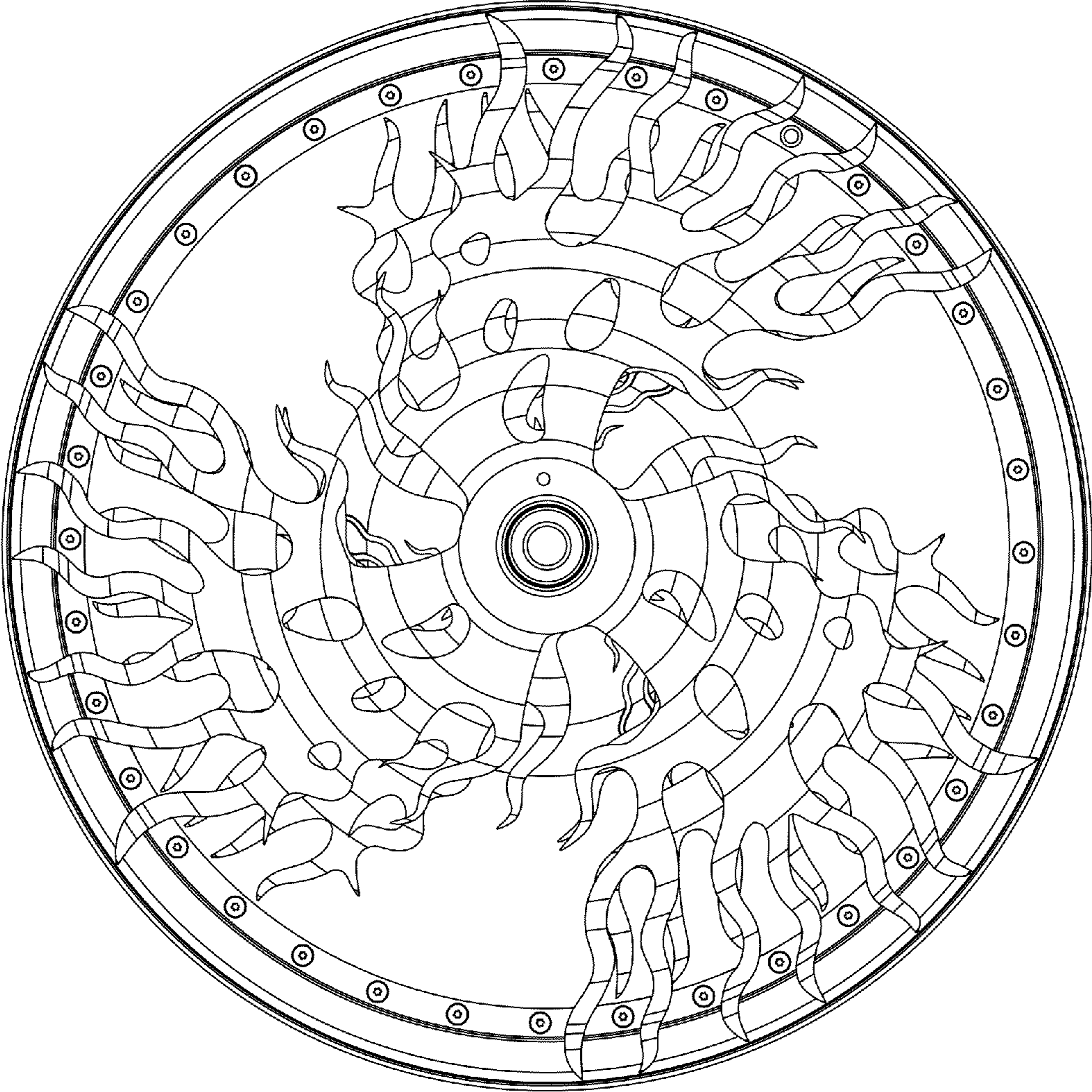

Fig. 21