



US00D739777S

(12) **United States Design Patent**
Vu et al.

(10) **Patent No.:** **US D739,777 S**
(45) **Date of Patent:** **** Sep. 29, 2015**

(54) **ACTIVITY MONITORING DEVICE**

- (71) Applicant: **Misfit Wearables Corporation**, Salem, NH (US)
- (72) Inventors: **Sonny X. Vu**, Salem, NH (US); **Matthew Ryan Montgomery**, Palo Alto, CA (US); **Jessica Ng Sheung-Yan**, San Francisco, CA (US)
- (73) Assignee: **Misfit Wearables Corporation**, Salem, NH (US)
- (**) Term: **14 Years**
- (21) Appl. No.: **29/504,714**
- (22) Filed: **Oct. 8, 2014**

Related U.S. Application Data

- (62) Division of application No. 29/461,314, filed on Jul. 22, 2013, now Pat. No. Des. 717,674.
- (51) **LOC (10) Cl.** **10-04**
- (52) **U.S. Cl.**
USPC **D10/103; D10/126**
- (58) **Field of Classification Search**
USPC D10/30-39, 65, 70, 97, 98, 102, 103, D10/122-124, 126, 128; D11/3, 79-81, 85; D14/138 R, 203.5, 203.6, 341, 344, D14/347; D24/167, 168
CPC A44C 5/00-5/16; G04B 37/00-37/228; G04B 45/0069; G04B 47/04; G04B 19/00; G04B 19/34; G04B 21/12; G04B 23/12; G04B 47/00-47/068; G01C 17/00; G01C 21/00-21/3697
See application file for complete search history.

(56) **References Cited**

U.S. PATENT DOCUMENTS

- 3,744,236 A * 7/1973 Kishida 368/226
- D246,104 S * 10/1977 Vong D14/192

(Continued)

OTHER PUBLICATIONS

Response to Election/Restriction mailed Jun. 23, 2014, issued for Design U.S. Appl. No. 29/461,314 (8 pages).

Primary Examiner — Antoine D Davis
(74) *Attorney, Agent, or Firm* — Cooley LLP

(57) **CLAIM**

The ornamental design for an activity monitoring device, as shown and described.

DESCRIPTION

FIG. 1 is a top perspective view of a first embodiment; FIG. 2 is a bottom perspective view of the first embodiment; FIG. 3 is a top view of the first embodiment; FIG. 4 is a bottom view of the first embodiment; FIG. 5 is a left side view of the first embodiment; FIG. 6 is a right side view of the first embodiment; FIG. 7 is a back view of the embodiment; FIG. 8 is a front view of the first embodiment; FIG. 9 is a top perspective view of a second embodiment; FIG. 10 is a bottom perspective view of the second embodiment; FIG. 11 is a top view of the second embodiment; FIG. 12 is a bottom view of the second embodiment; FIG. 13 is a left side view of the second embodiment; FIG. 14 is a right side view of the second embodiment; FIG. 15 is a back view of the second embodiment; FIG. 16 is a front view of the second embodiment; FIG. 17 is a top perspective view of a third embodiment; FIG. 18 is a bottom perspective view of the third embodiment; FIG. 19 is a top view of the third embodiment; FIG. 20 is a bottom view of the third embodiment; FIG. 21 is a left side view of the third embodiment; FIG. 22 is a right side view of the third embodiment; FIG. 23 is a back view of the third embodiment; and, FIG. 24 is a front view of the third embodiment.

The broken lines immediately adjacent the shaded areas represent the bounds of the claimed design while all other broken lines are directed to environment and are for illustrative purposes only; the broken lines form no part of the claimed design.

1 Claim, 18 Drawing Sheets

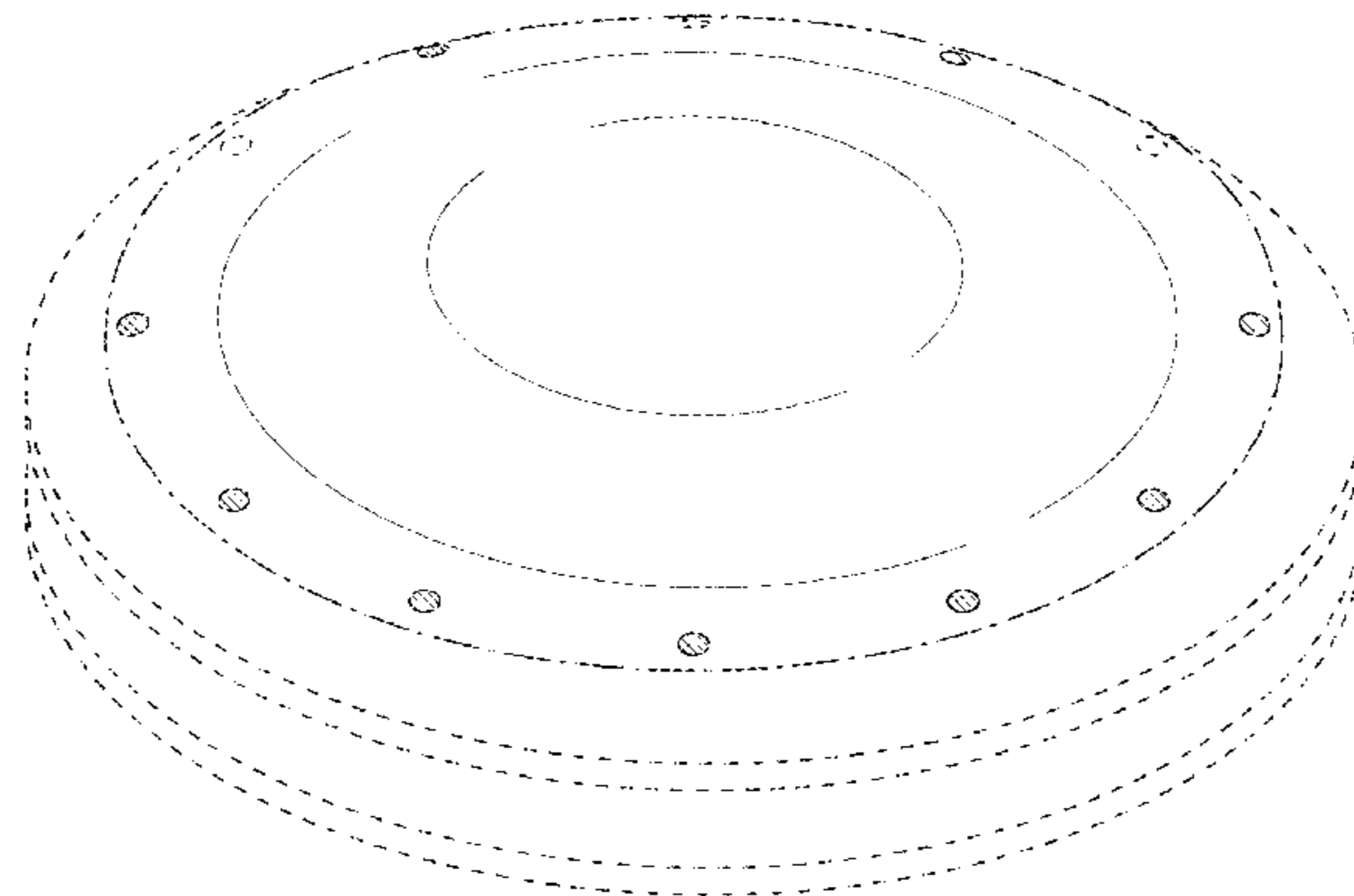

(56)

References Cited

U.S. PATENT DOCUMENTS

D249,874 S *	10/1978	Lawrence	D10/38	8,199,612 B2 *	6/2012	Jolidon	368/223
D349,864 S *	8/1994	Dunlap et al.	D11/3	D664,456 S	7/2012	Trine et al.		
D364,099 S *	11/1995	Bergeron	D10/33	D668,164 S	10/2012	Cowles et al.		
D417,236 S *	11/1999	Burrus	D19/28	D671,026 S *	11/2012	Thurau	D10/126
6,208,593 B1 *	3/2001	Liao	368/232	8,400,883 B2 *	3/2013	Lin	368/228
D486,090 S *	2/2004	Thomson	D10/123	8,477,567 B2 *	7/2013	Greubel et al.	368/220
7,134,784 B1 *	11/2006	Marin	368/295	D687,328 S	8/2013	Clymer et al.		
7,180,830 B1 *	2/2007	Cotsen	368/80	D692,332 S	10/2013	Ni et al.		
D596,051 S *	7/2009	Mille	D10/38	D695,145 S *	12/2013	De Belder	D10/126
					D700,080 S	2/2014	Broadbent et al.		
					D708,073 S *	7/2014	Parmigiani	D10/38
					D709,785 S *	7/2014	Stegmann	D10/126

* cited by examiner

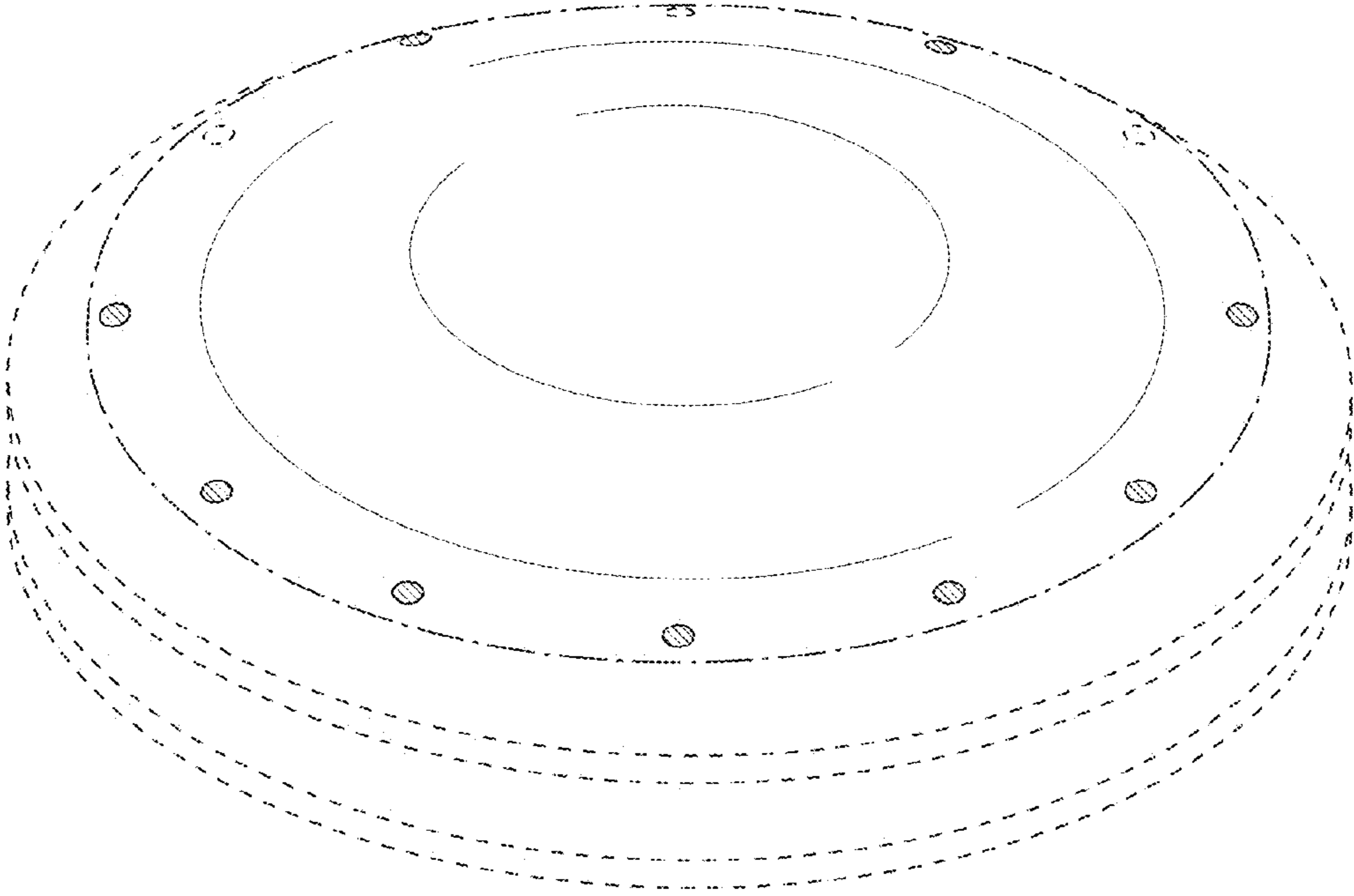

FIG.1

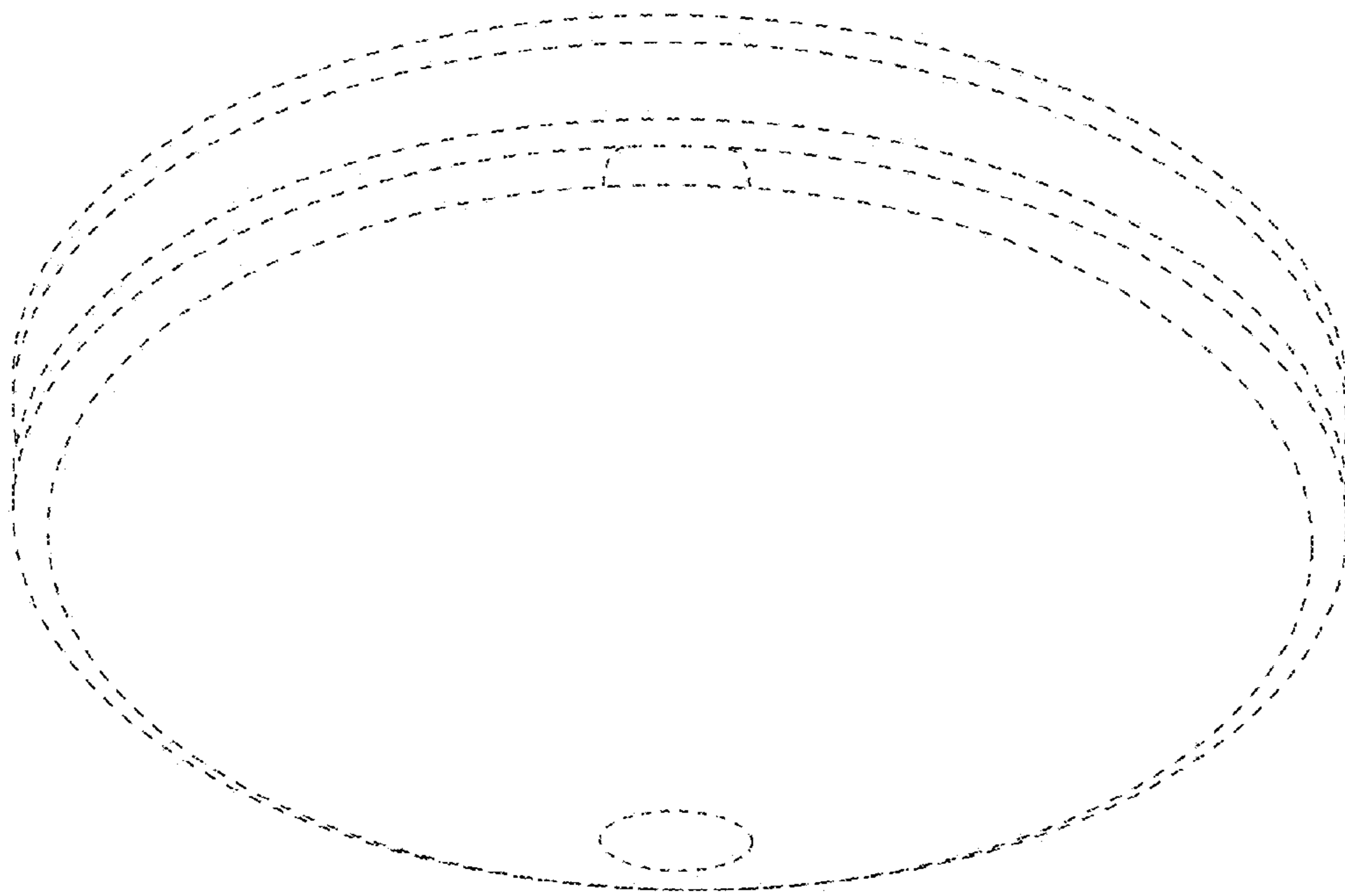

FIG. 2

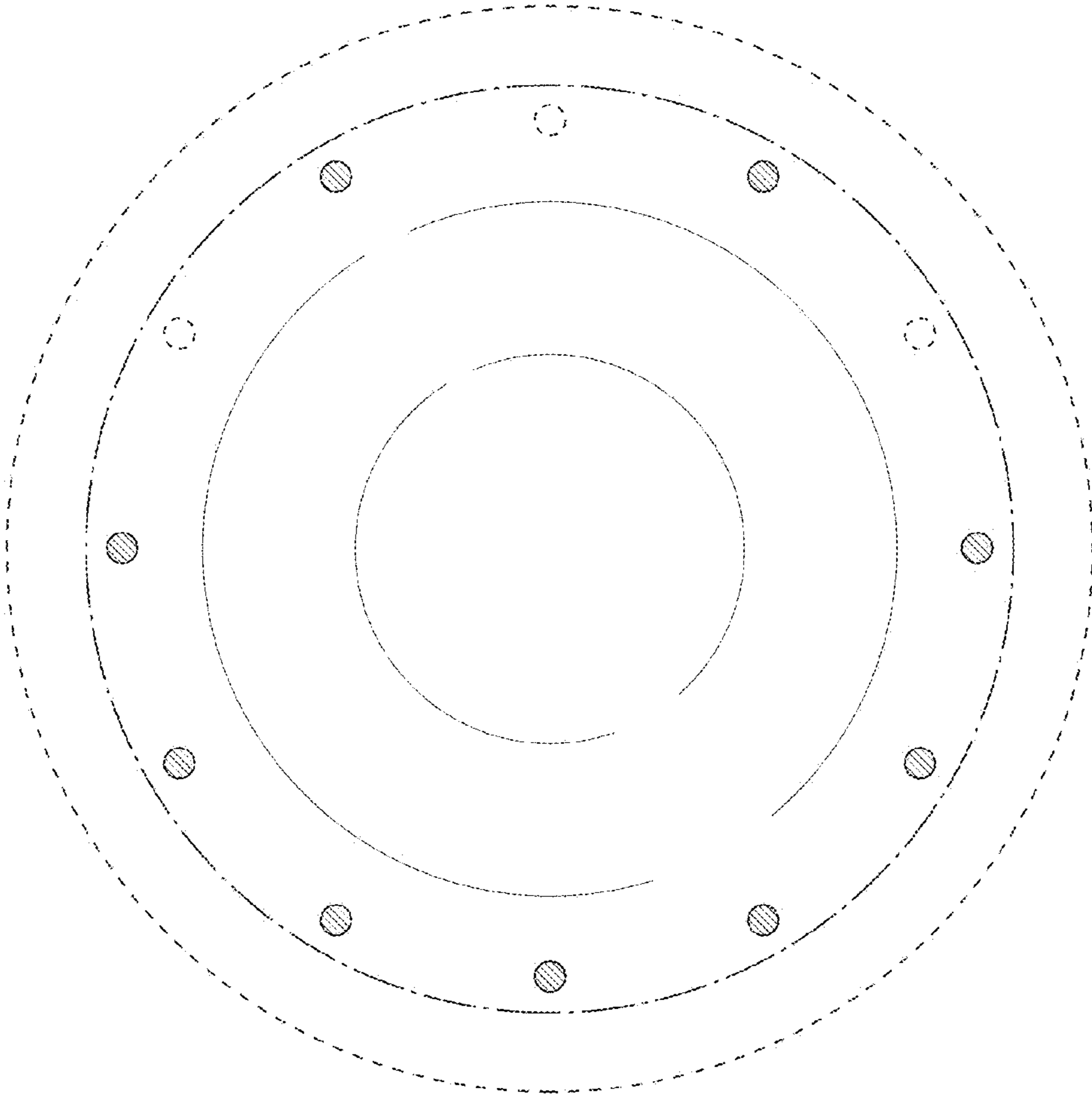

FIG.3

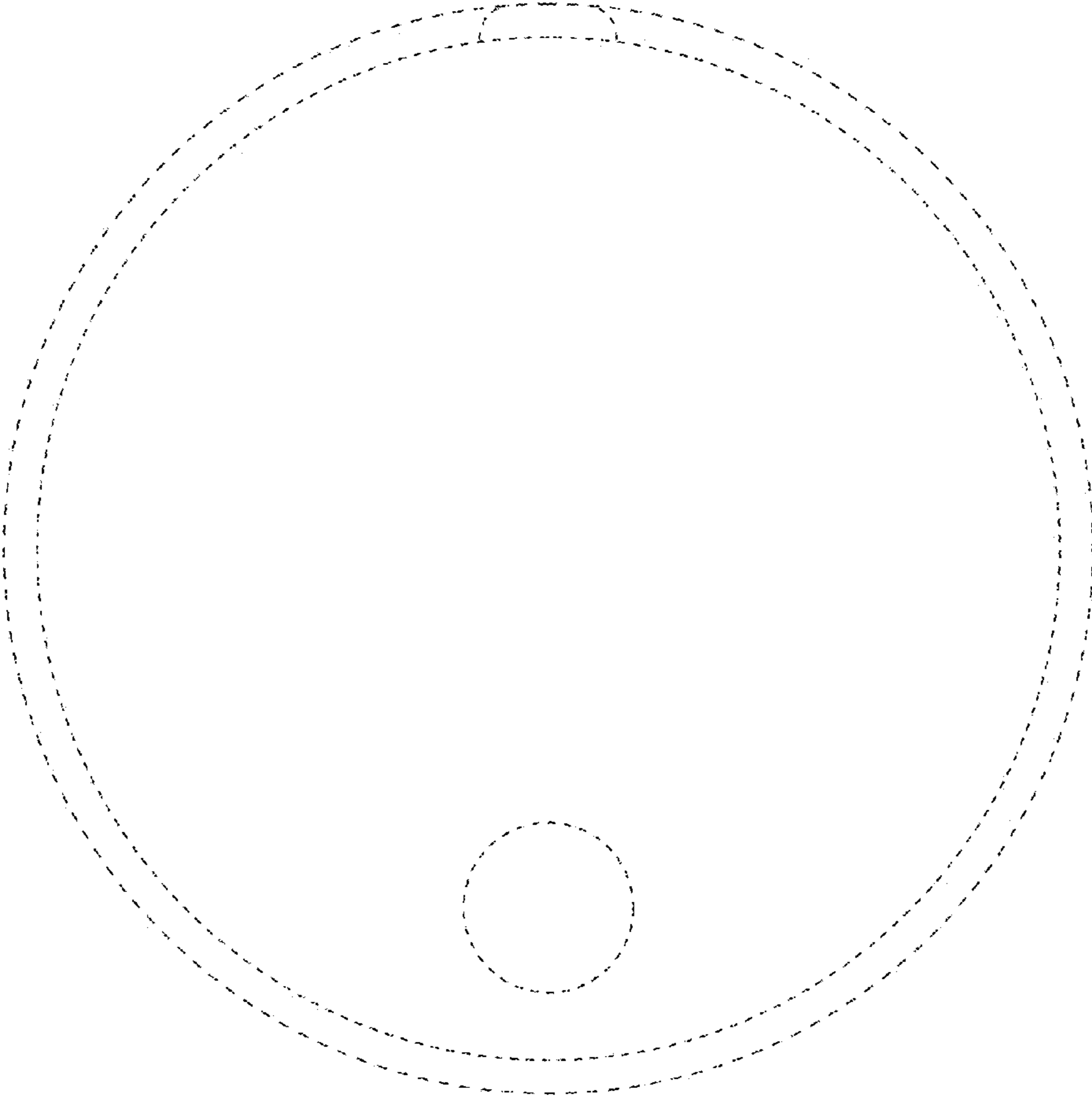

FIG.4

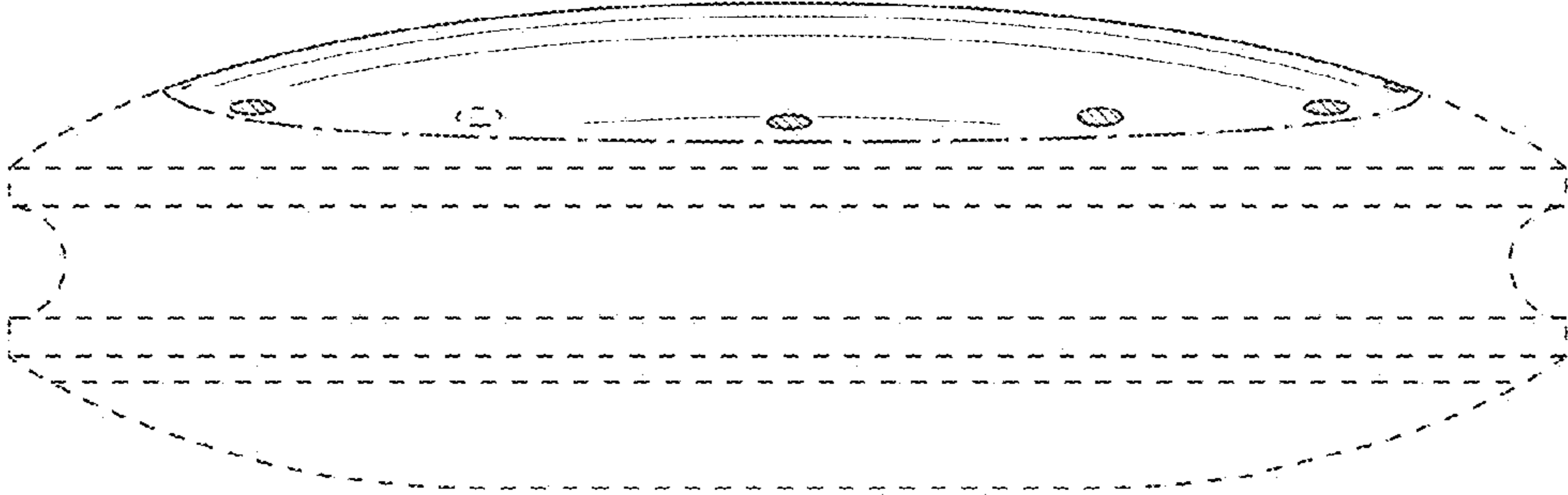

FIG. 5

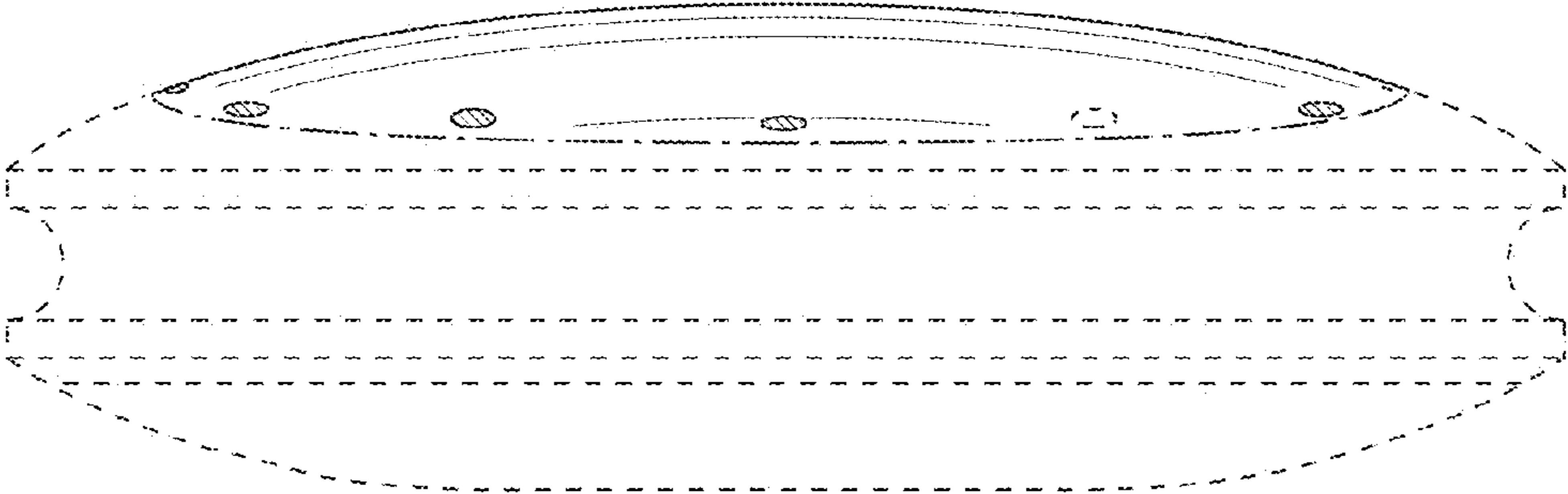

FIG. 6

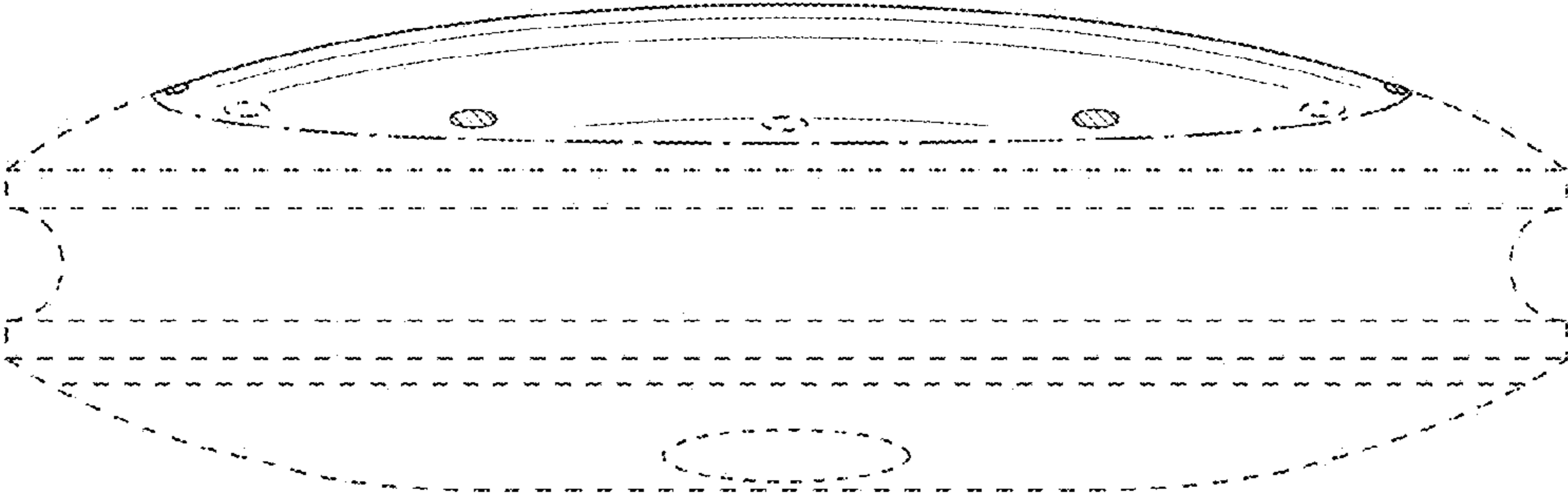

FIG. 7

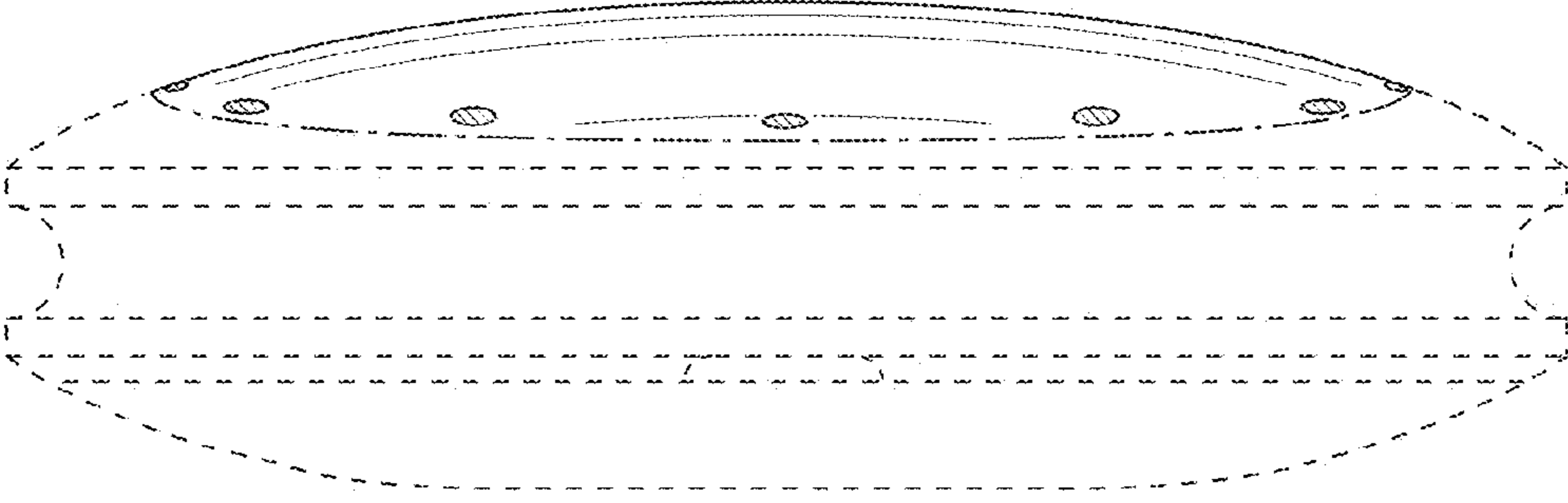

FIG. 8

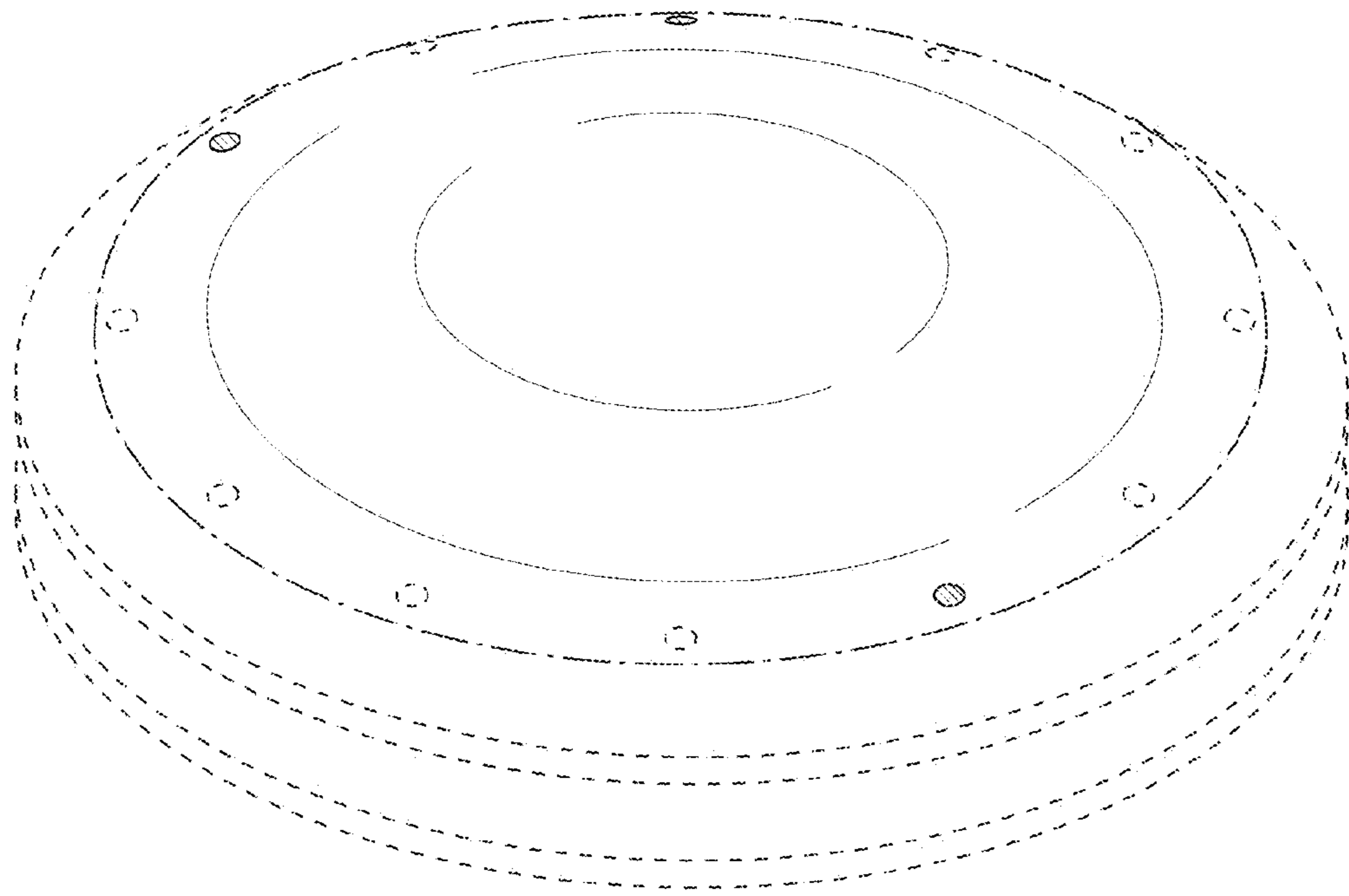

FIG. 9

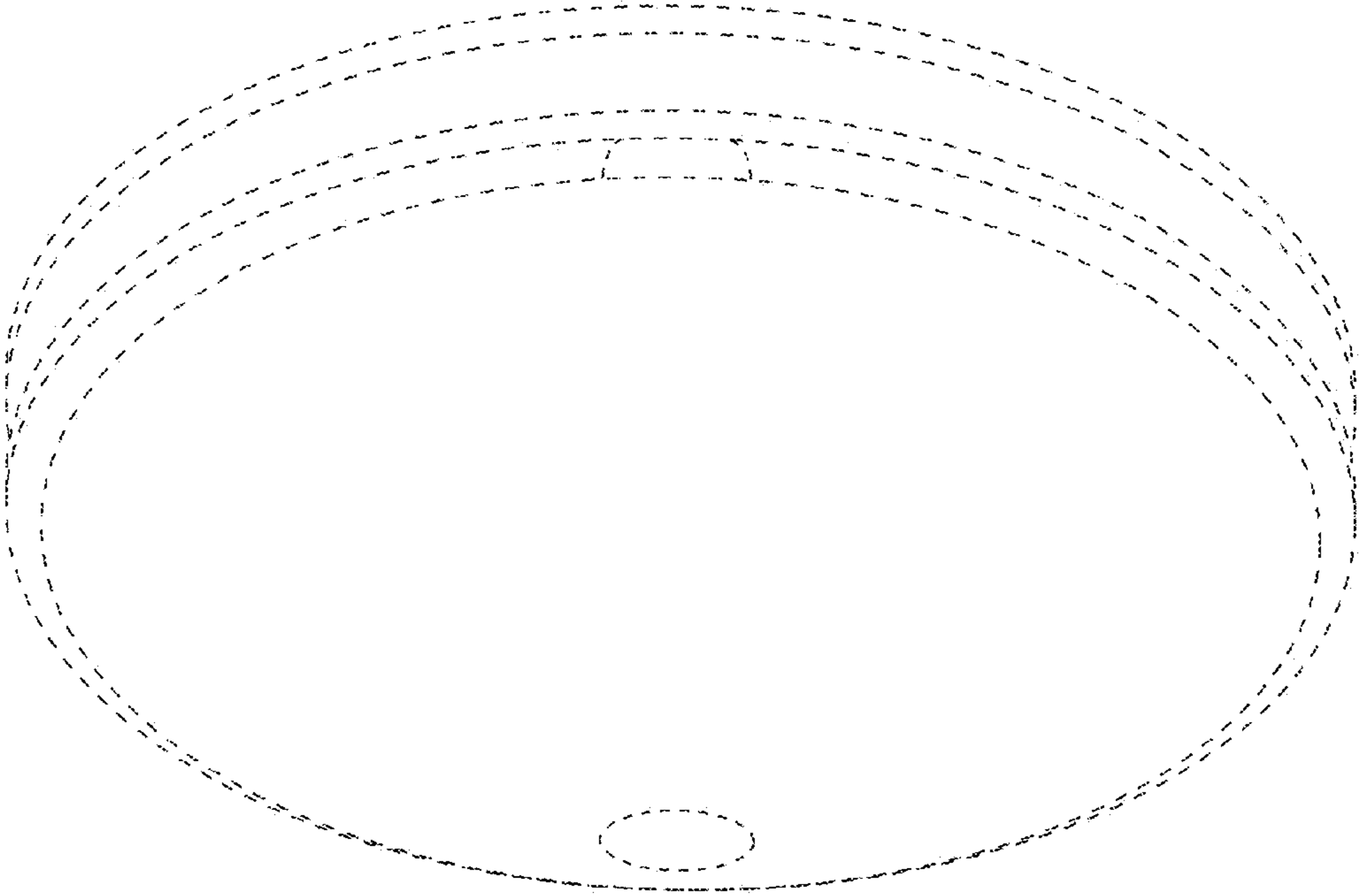

FIG. 10

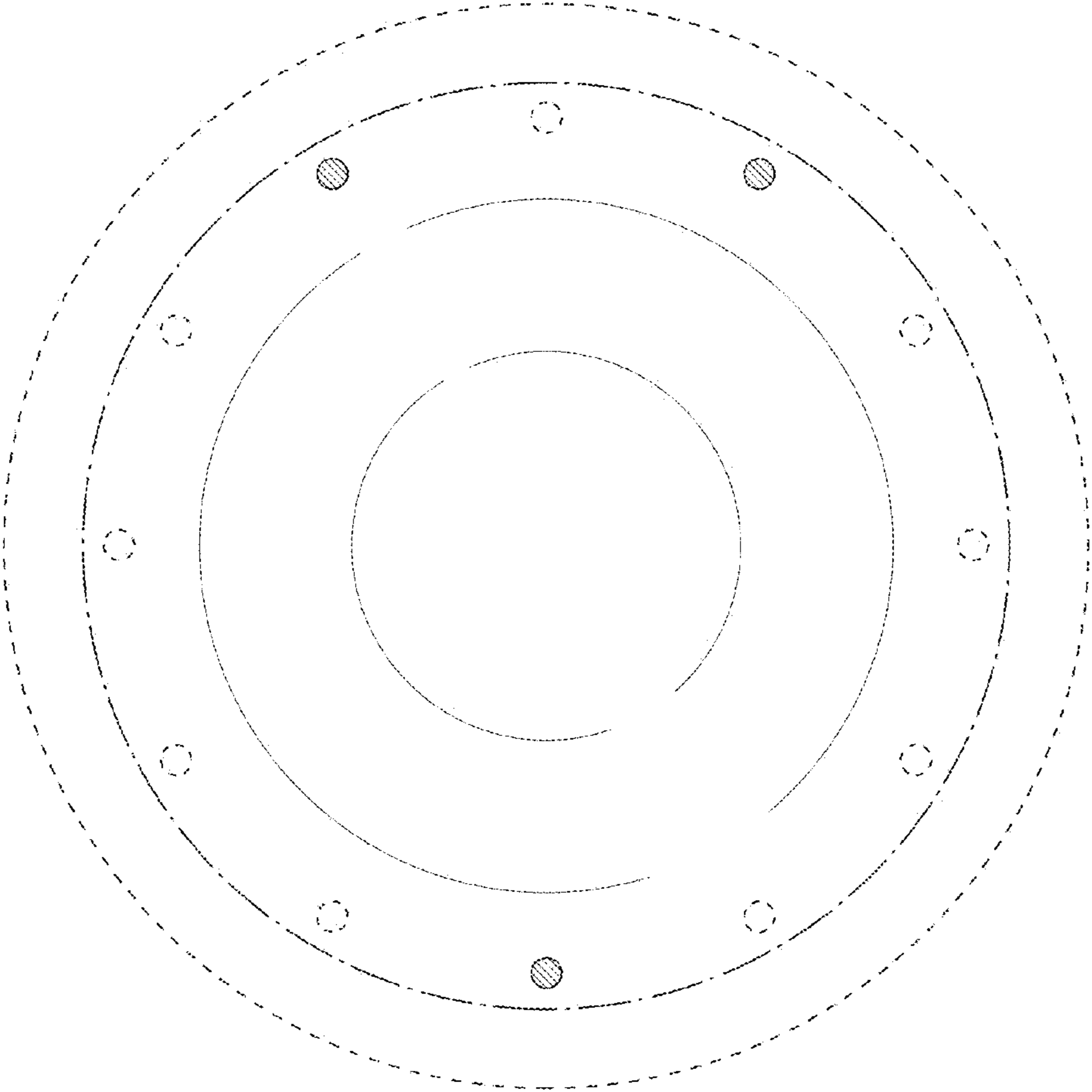

FIG.11

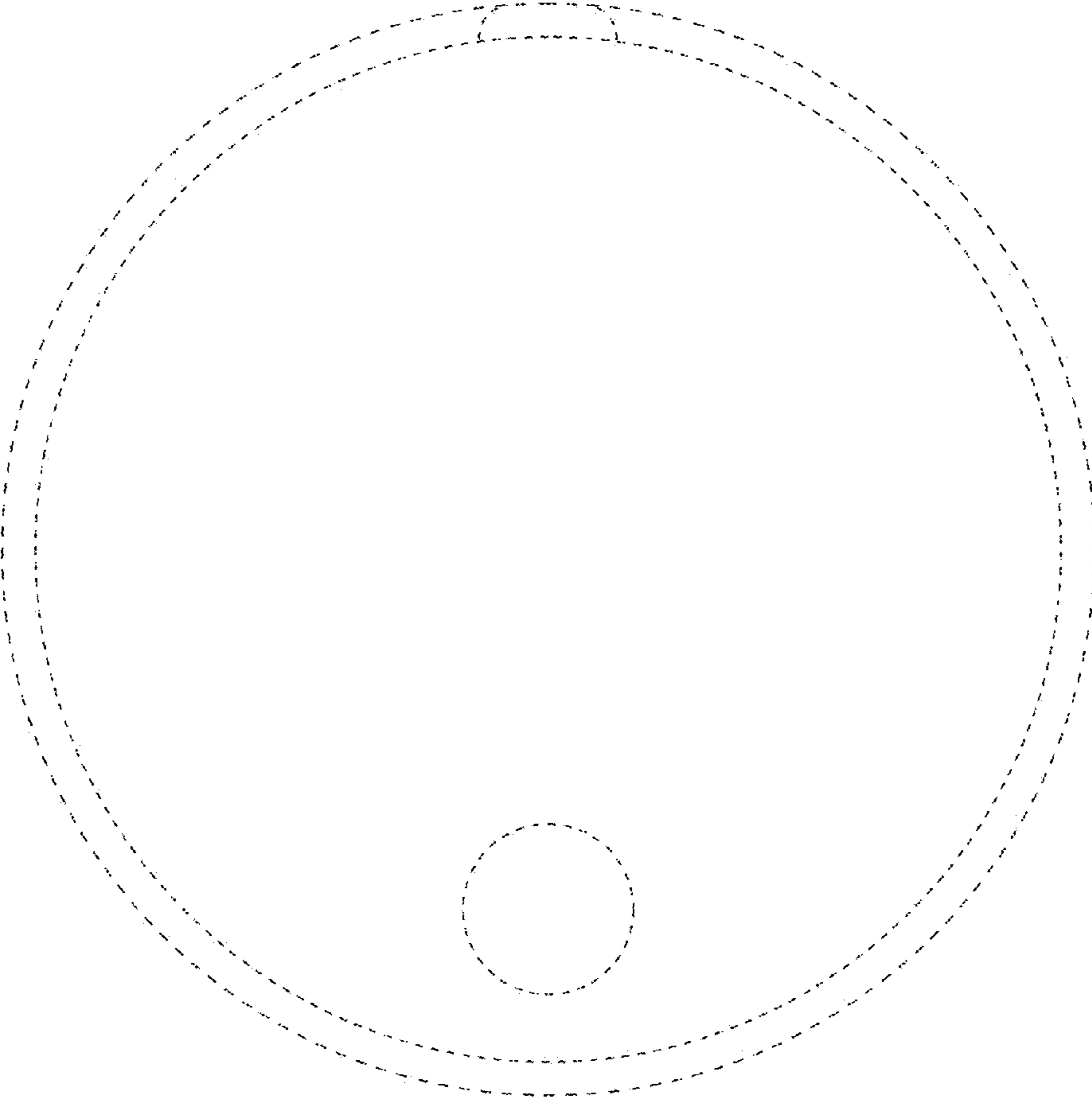

FIG. 12

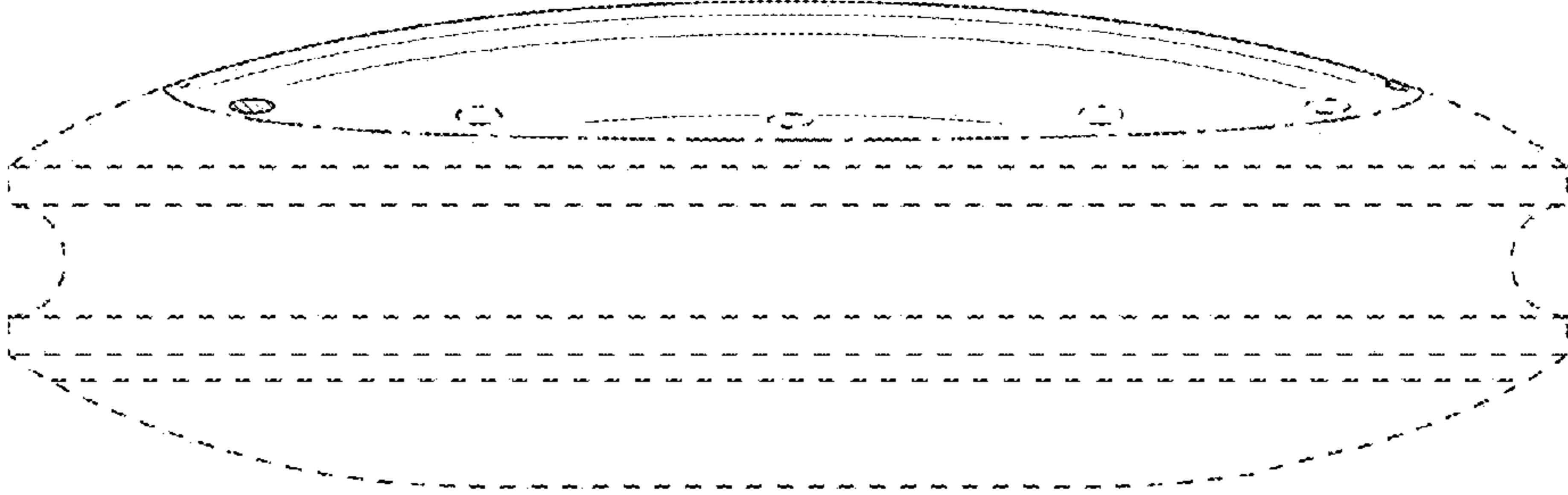

FIG. 13

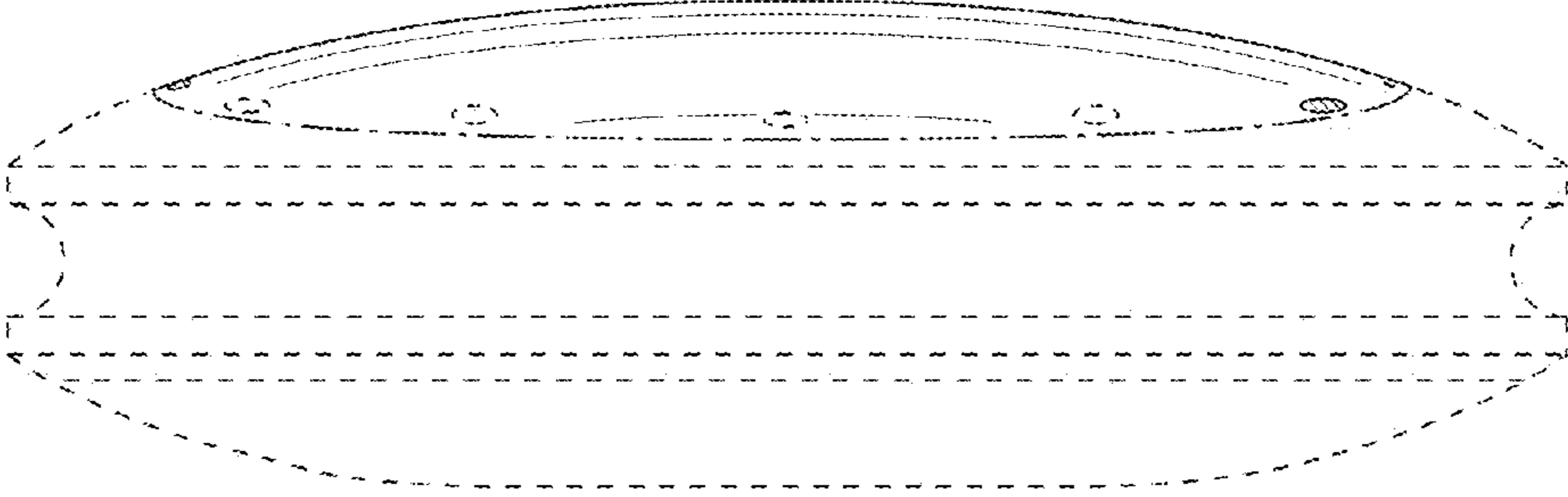

FIG. 14

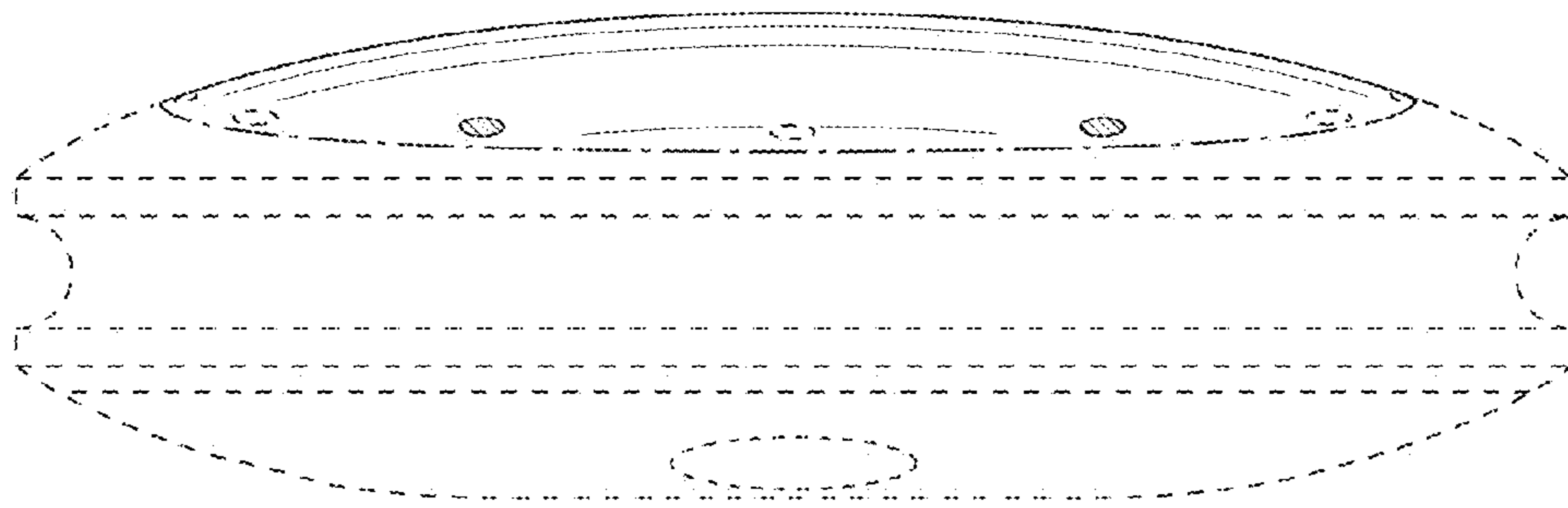

FIG. 15

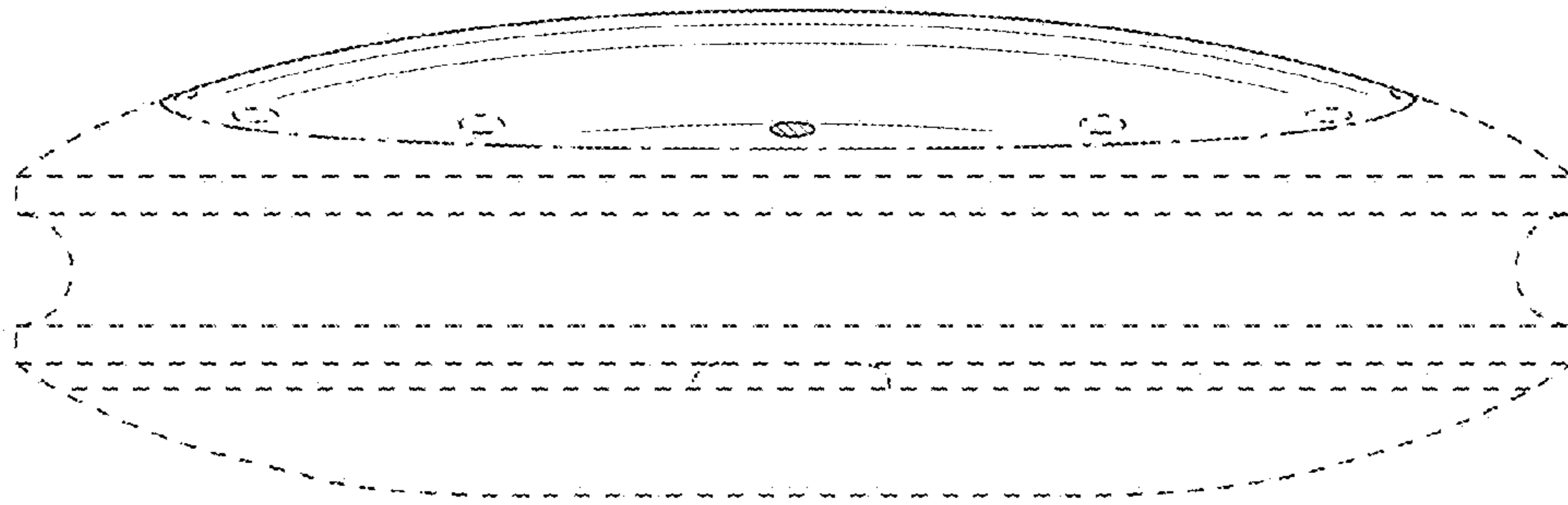

FIG. 16

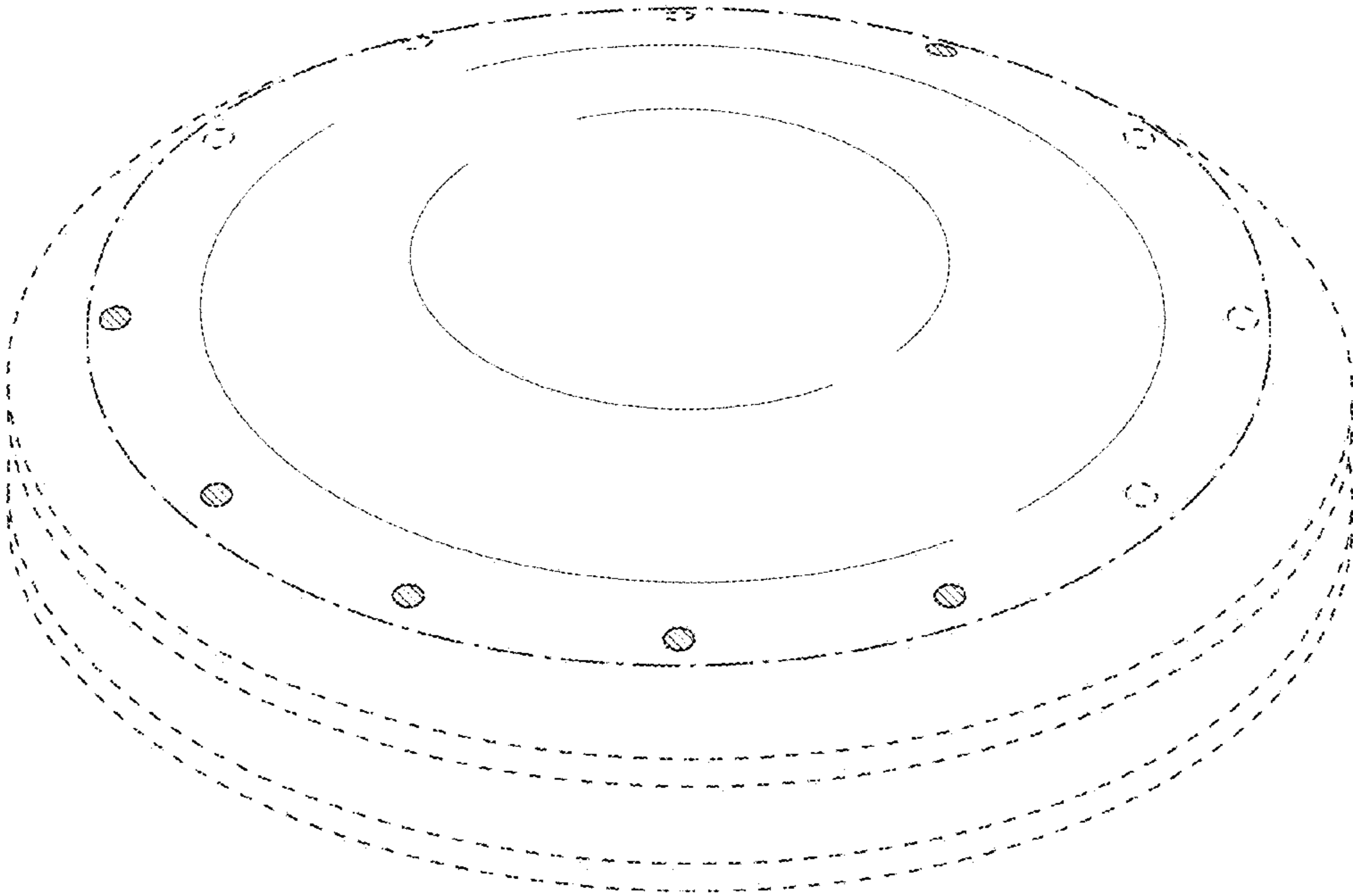

FIG.17

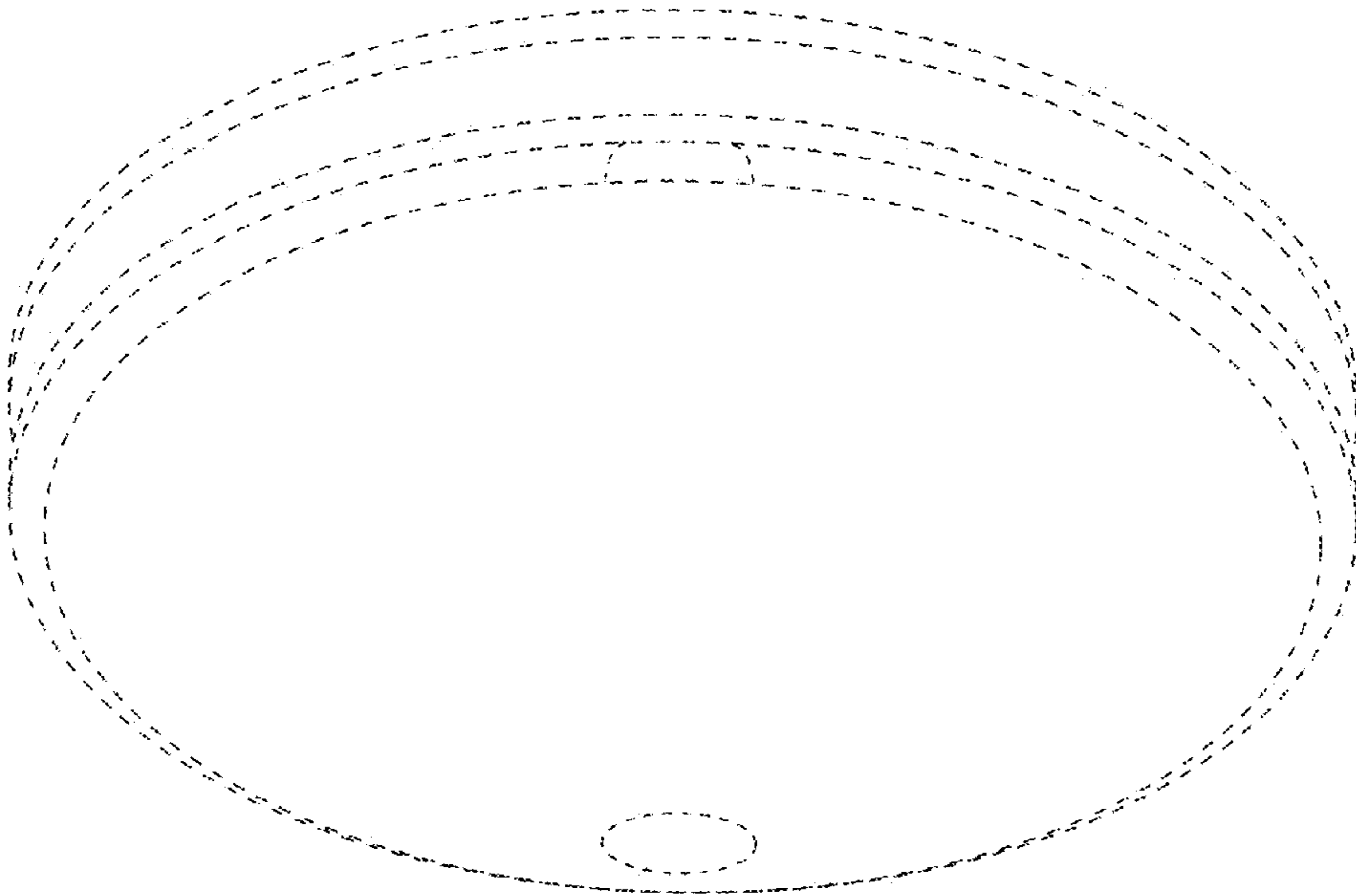

FIG.18

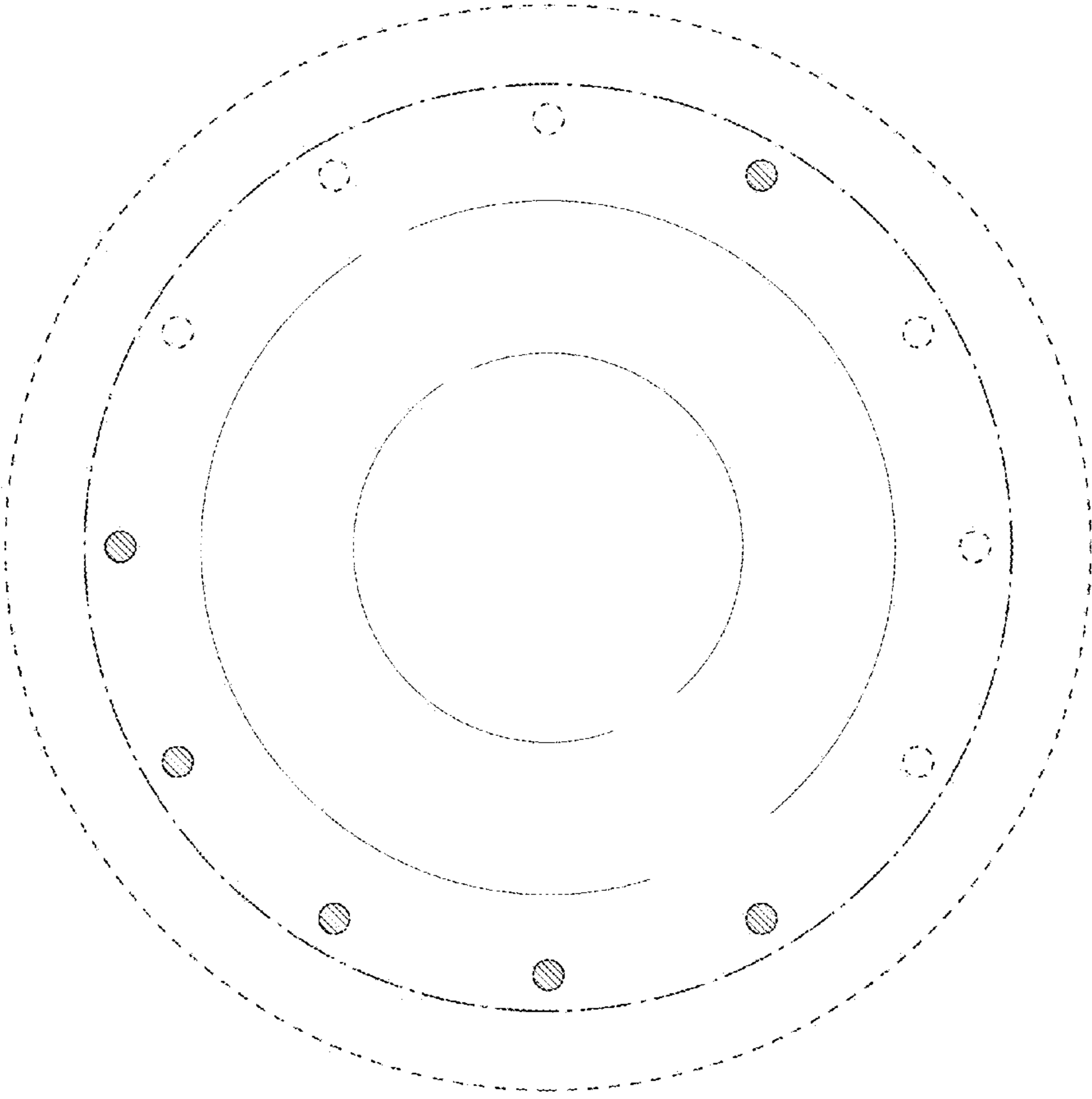

FIG.19

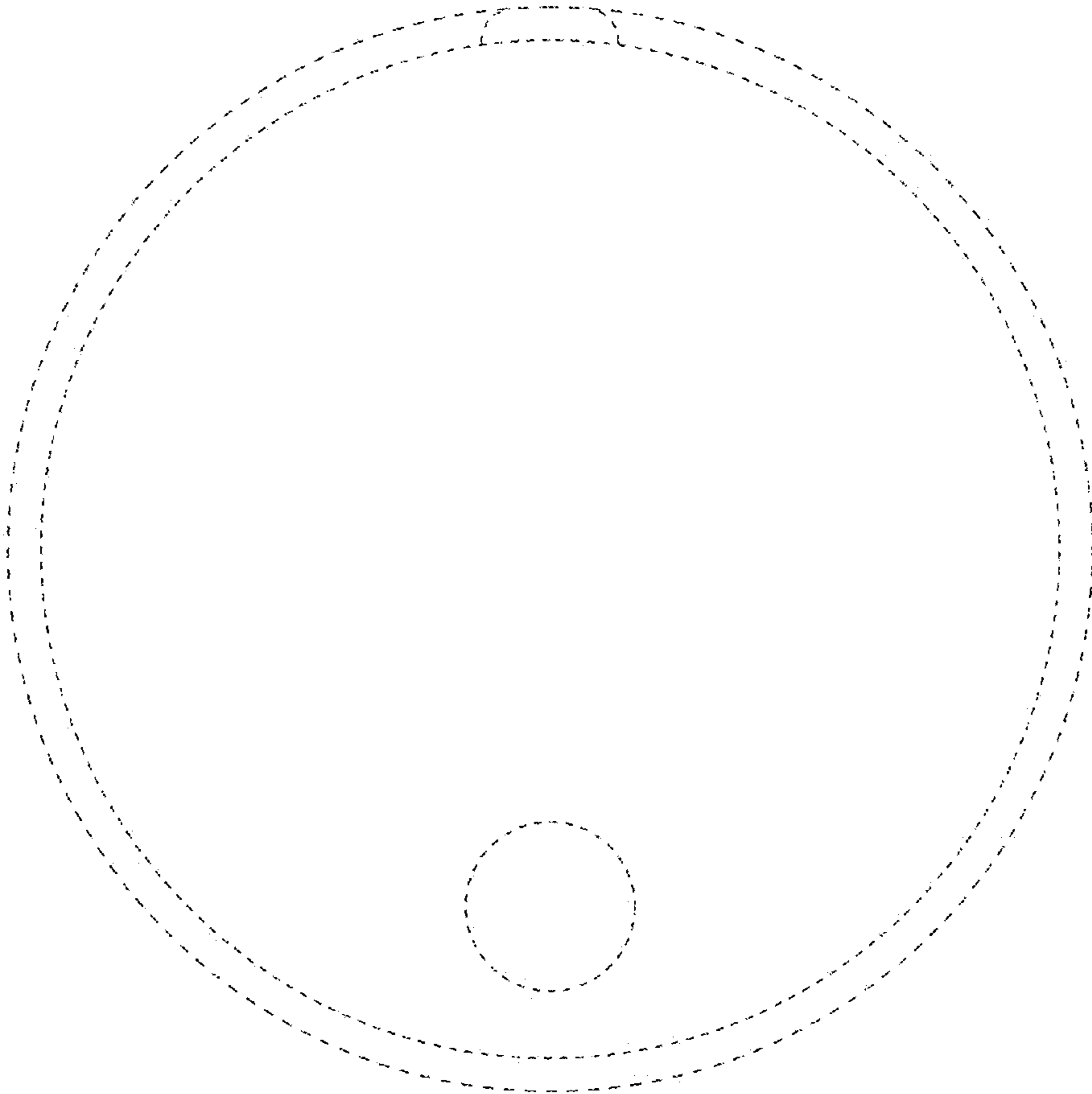

FIG.20

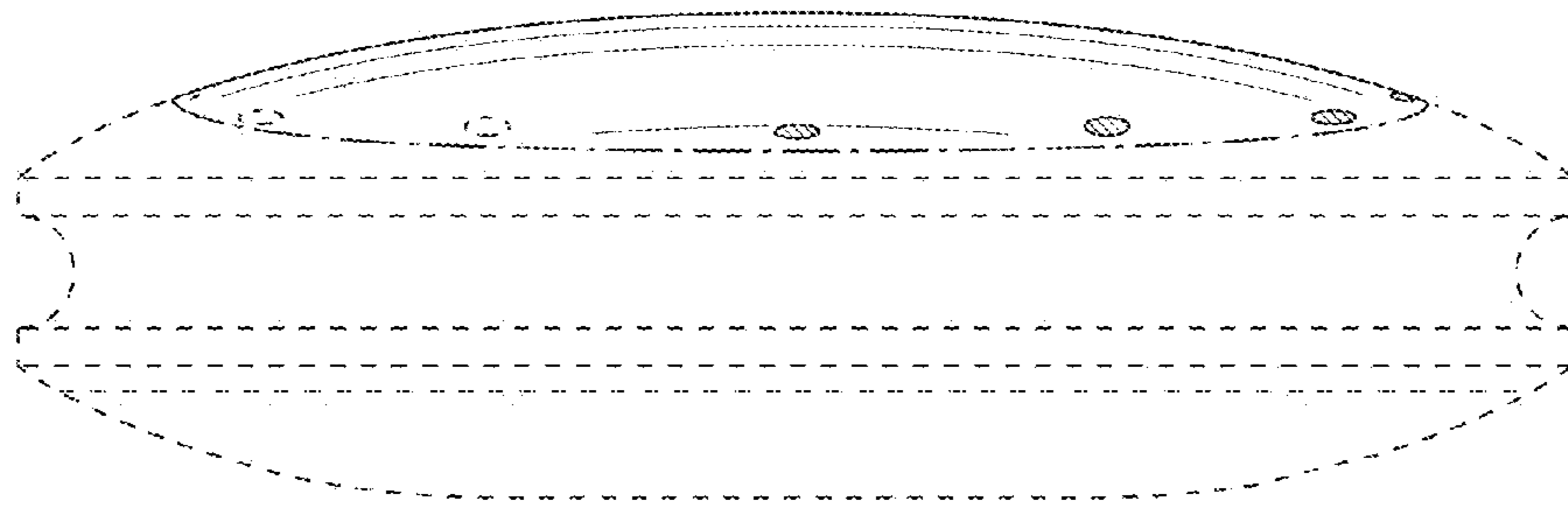

FIG. 21

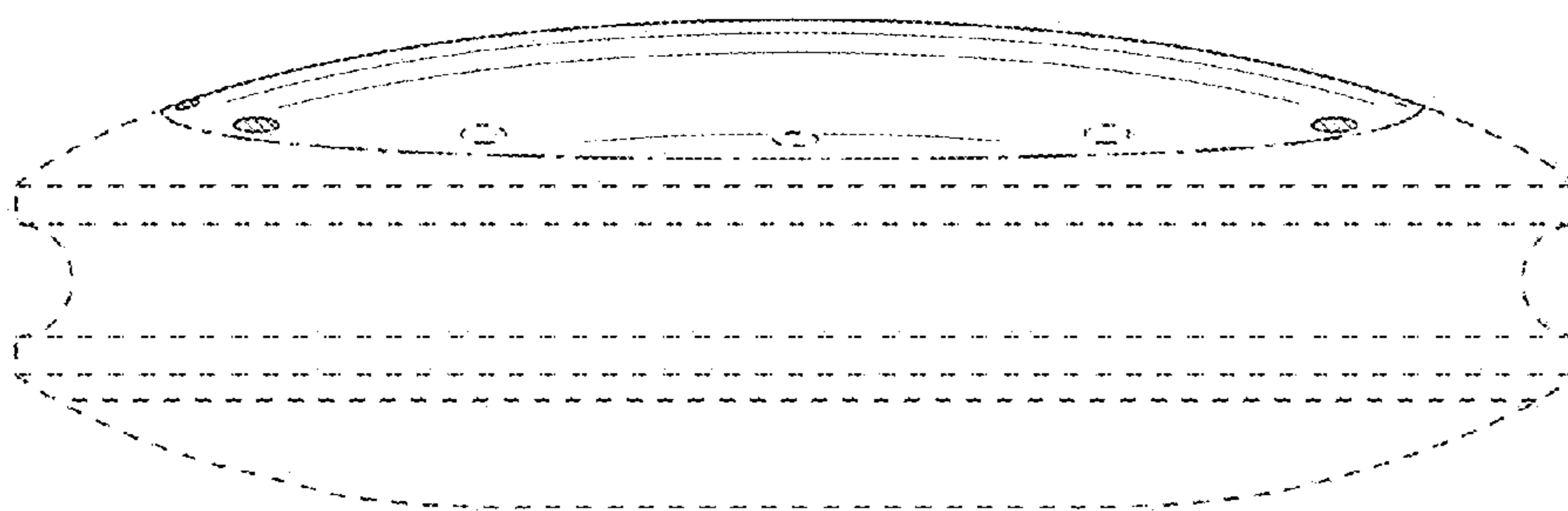

FIG. 22

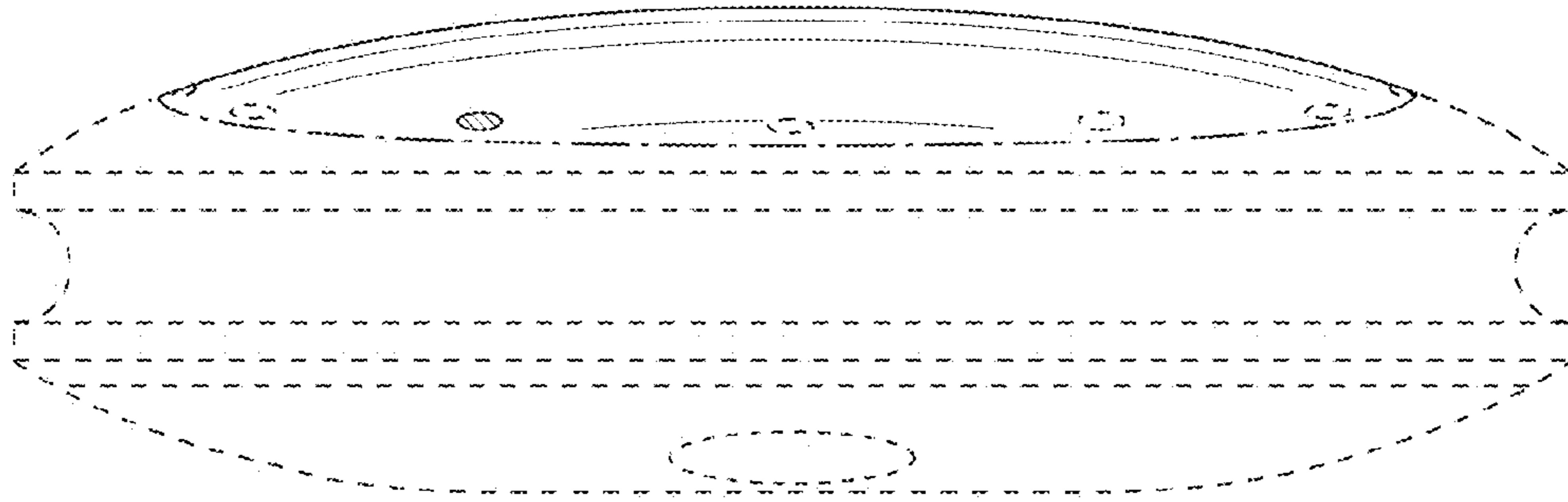

FIG. 23

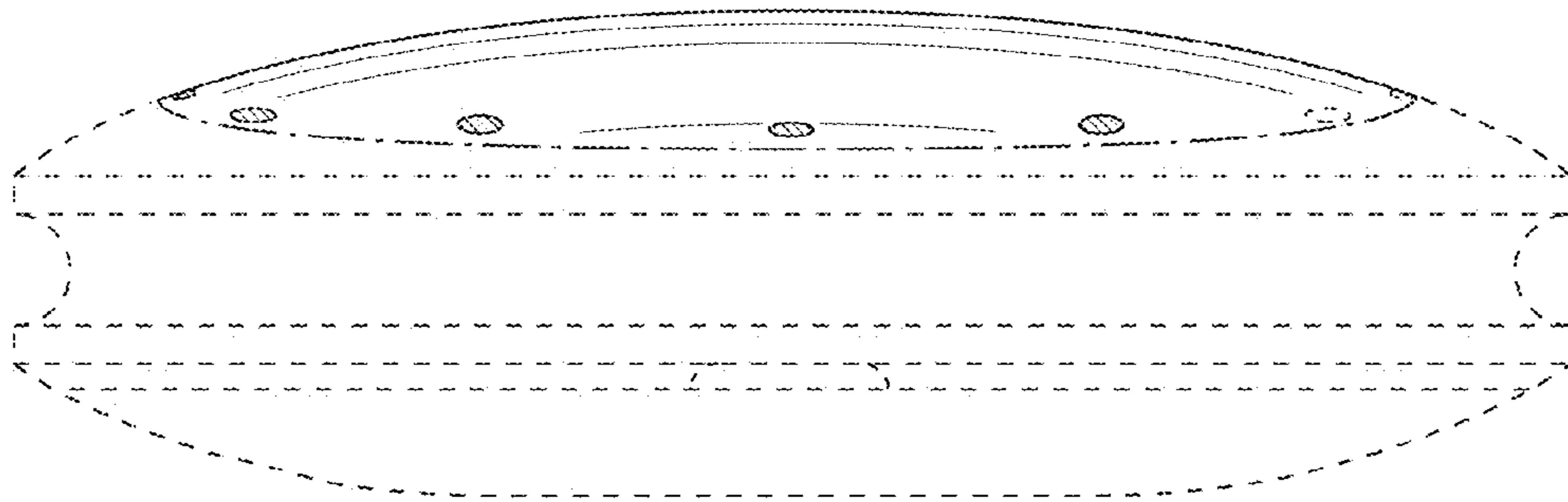

FIG. 24