



US00D739761S

(12) **United States Design Patent**  
**Zerba et al.**

(10) **Patent No.:** **US D739,761 S**

(45) **Date of Patent:** **\*\* Sep. 29, 2015**

(54) **BOTTLE**

(71) Applicant: **The Dial Corporation**, Scottsdale, AZ  
(US)

(72) Inventors: **Mark Zerba**, Scottsdale, AZ (US); **Amy K. Rhodes**, Phoenix, AZ (US); **Ares Marasligiller**, Cincinnati, OH (US); **Yashodan Dhuru**, Cincinnati, OH (US); **Jeffrey M. Rosenfeld**, Phoenix, AZ (US)

(73) Assignee: **The Dial Corporation**, Scottsdale, AZ  
(US)

(\*\*) Term: **14 Years**

(21) Appl. No.: **29/477,597**

(22) Filed: **Dec. 24, 2013**

(51) **LOC (10) Cl.** ..... **09-01**

(52) **U.S. Cl.**  
USPC ..... **D9/565**; D9/560; D9/571

(58) **Field of Classification Search**  
USPC ..... D9/516, 530, 541-543, 544, 559-560,  
D9/565, 571, 682, 685, 693, 715, 719  
CPC ..... B65D 1/00; B65D 1/02; B65D 1/0223;  
B65D 23/00; B65D 81/00; B65D 2501/00;  
B65D 2501/009; B65D 2501/0081  
See application file for complete search history.

(56) **References Cited**

U.S. PATENT DOCUMENTS

D201,214 S \* 5/1965 St. Clair ..... D9/523  
D215,699 S \* 10/1969 Horne et al. .... D9/542  
D338,833 S \* 8/1993 Dinand ..... D9/516

D341,773 S \* 11/1993 Dinand ..... D9/693  
D504,620 S \* 5/2005 Kazuo et al. .... D9/685  
D542,145 S \* 5/2007 Campbell ..... D9/565  
D558,591 S \* 1/2008 Blasko et al. .... D9/691  
D639,174 S \* 6/2011 Seys ..... D9/540

\* cited by examiner

*Primary Examiner* — Dana L Meyrow

(74) *Attorney, Agent, or Firm* — David K. Benson

(57) **CLAIM**

The ornamental design for a bottle, as shown and described.

**DESCRIPTION**

FIG. 1 is a front perspective view of a bottle embodying our new design;  
FIG. 2 is a front side elevation view thereof;  
FIG. 3 is a rear side elevation view thereof;  
FIG. 4 is a left side elevation view thereof;  
FIG. 5 is a right side elevation view thereof;  
FIG. 6 is a top plan view thereof;  
FIG. 7 is a bottom plan view thereof;  
FIG. 8 is a front perspective view of the bottle of FIGS. 1-7 in an alternate condition, showing an unclaimed closure;  
FIG. 9 is a front side elevation view thereof;  
FIG. 10 is a rear side elevation view thereof;  
FIG. 11 is a left side elevation view thereof;  
FIG. 12 is a right side elevation view thereof;  
FIG. 13 is a top plan view thereof; and,  
FIG. 14 is a bottom plan view thereof.  
The broken lines in the drawings illustrate the portions of the design that form no part of the claim.

**1 Claim, 8 Drawing Sheets**

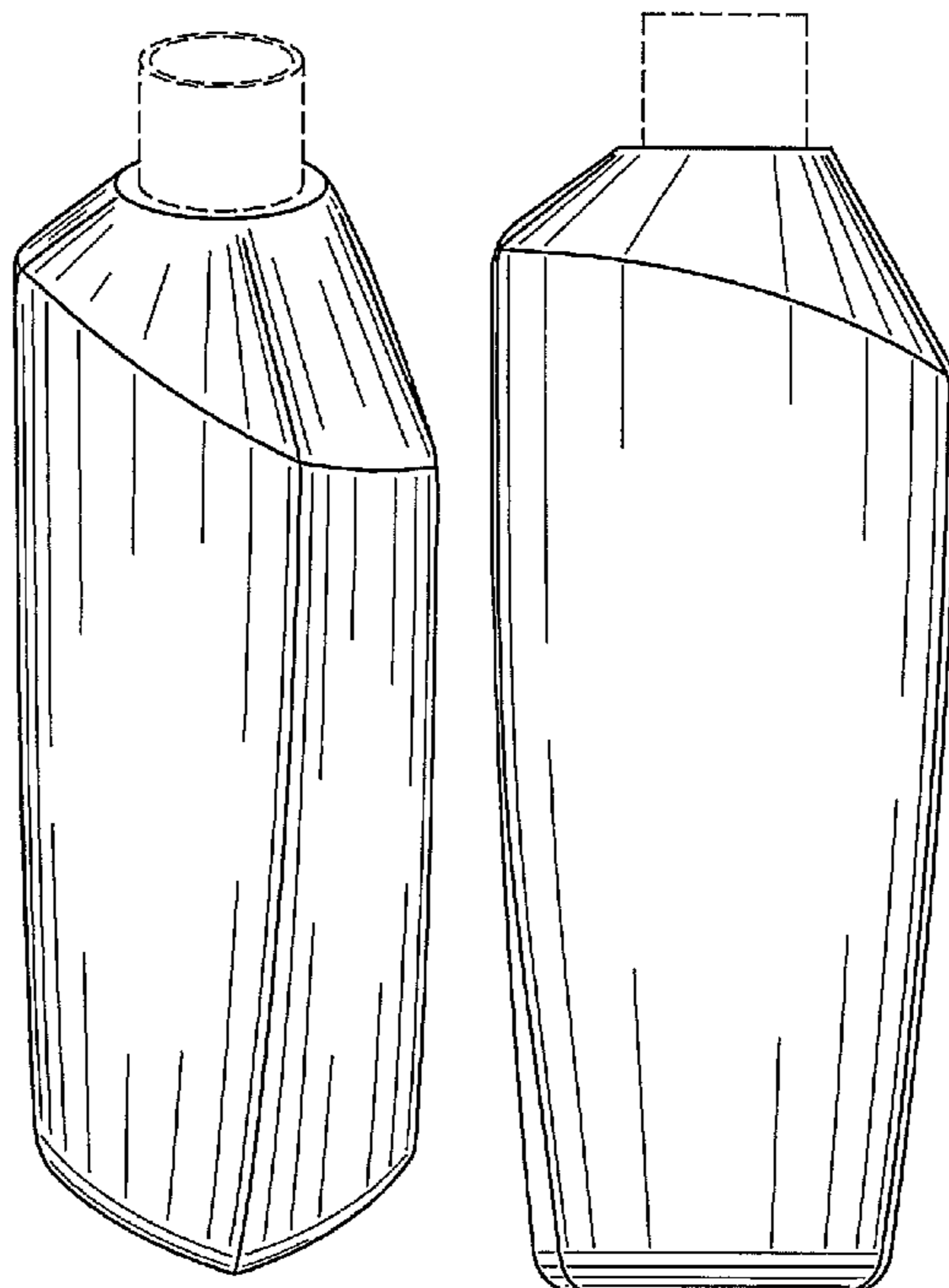

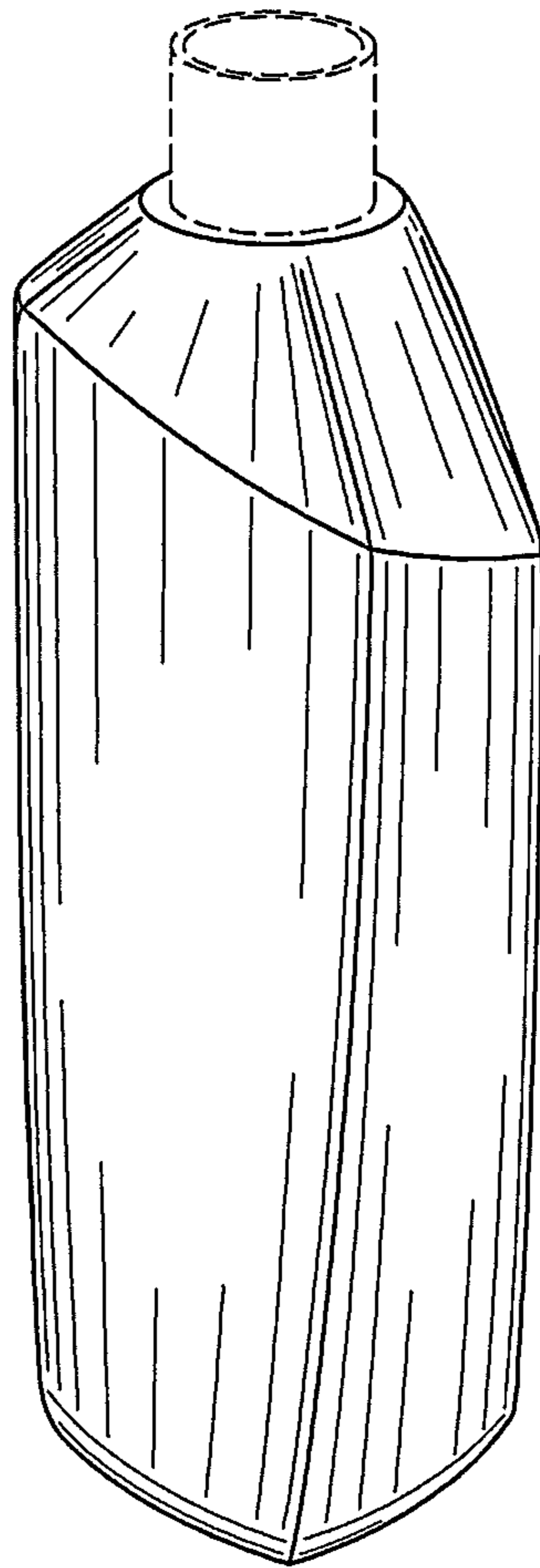

FIG. 1

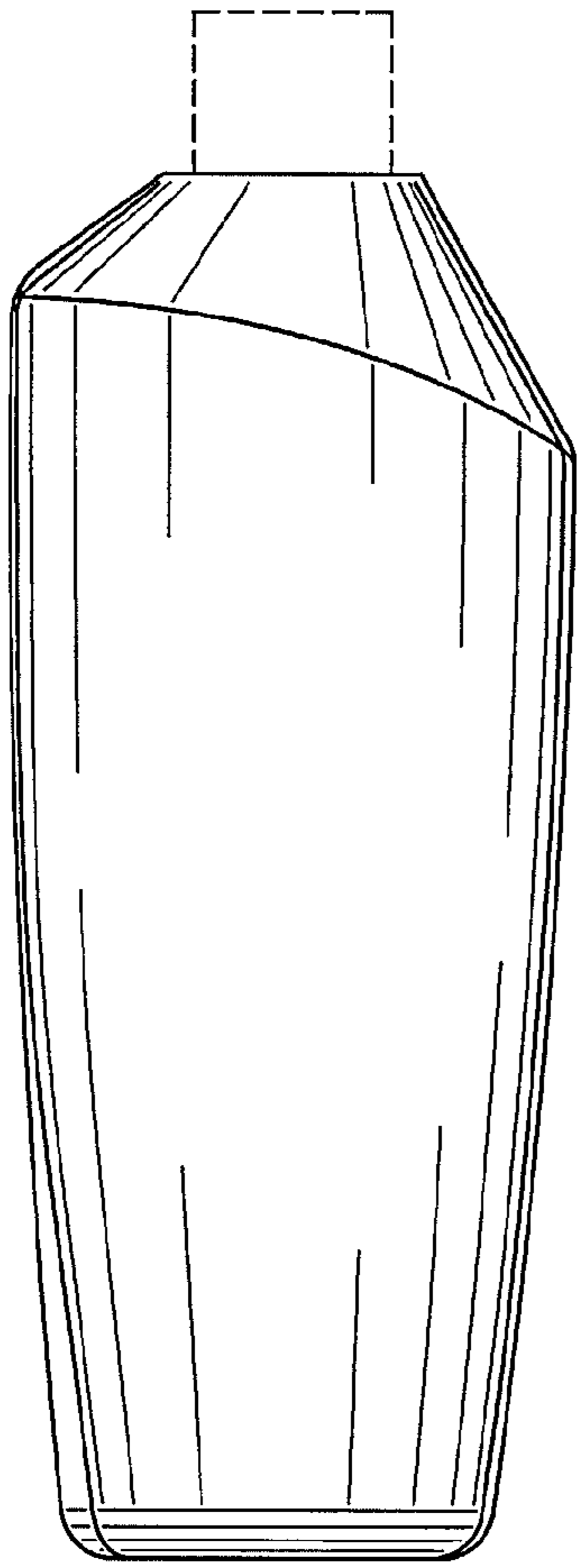

FIG. 2

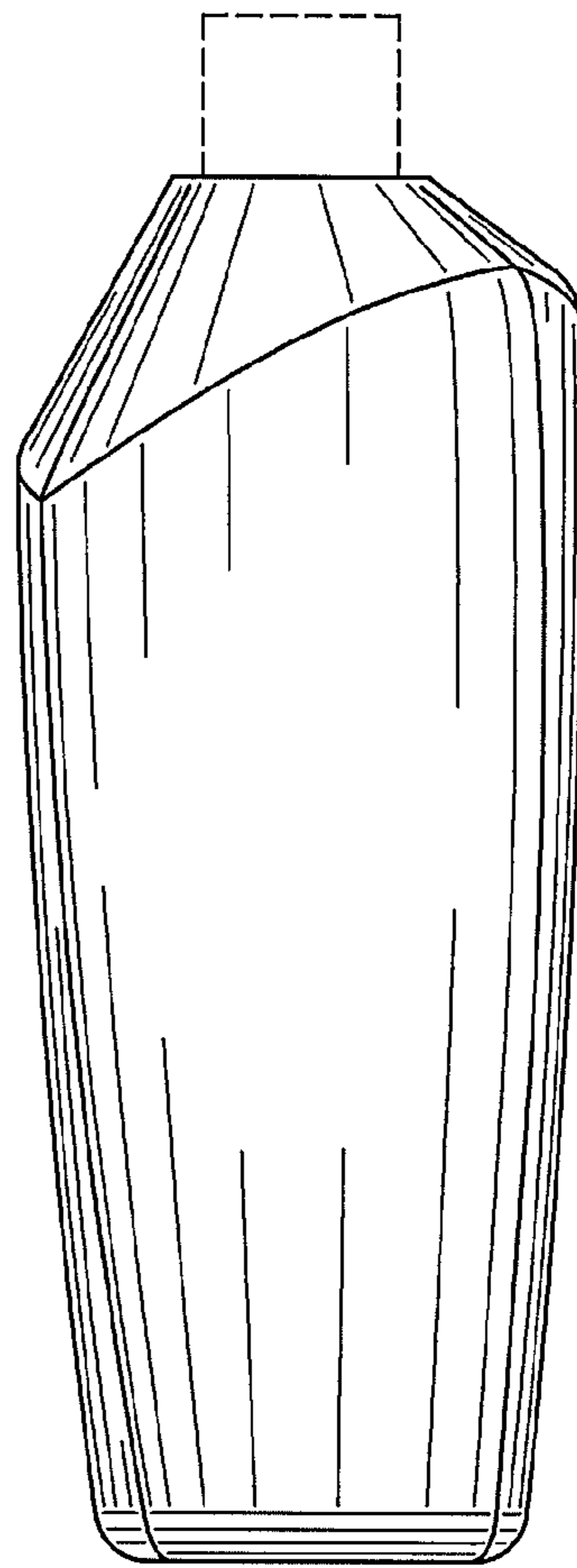

FIG. 3

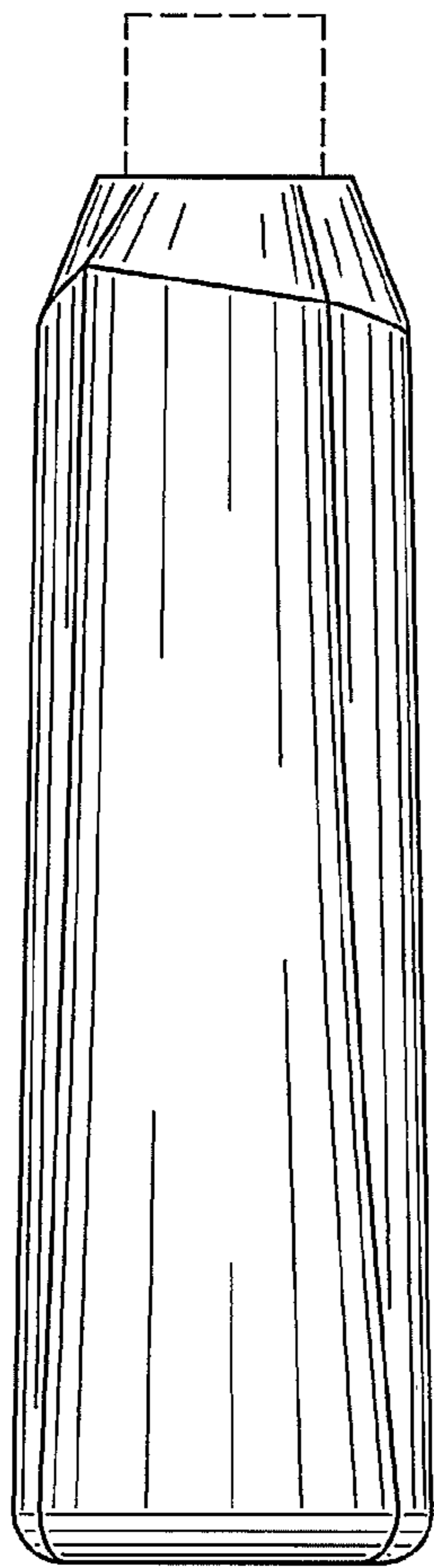

FIG. 4

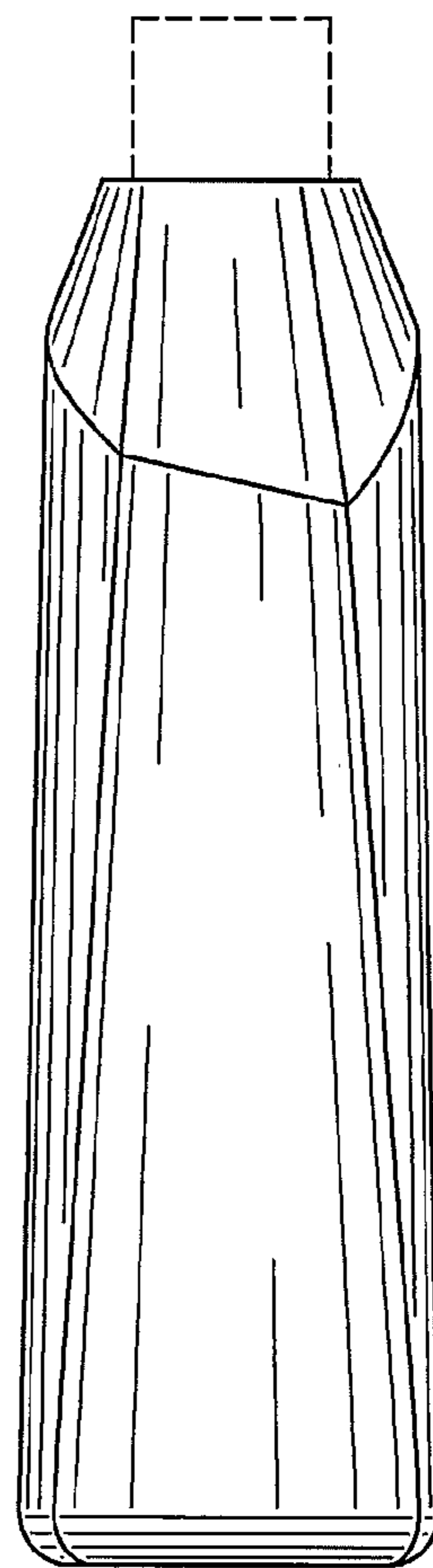

FIG. 5

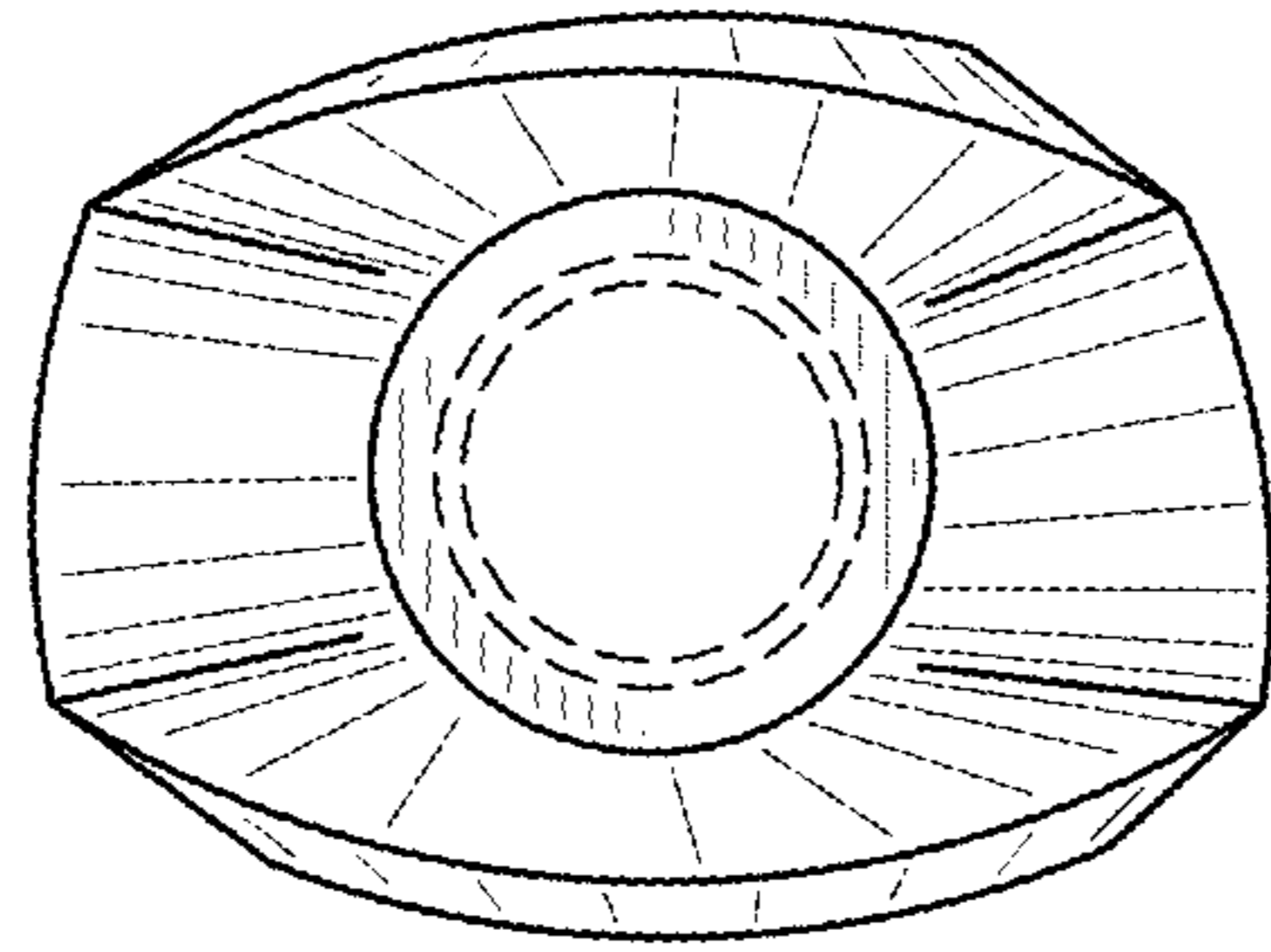

FIG. 6

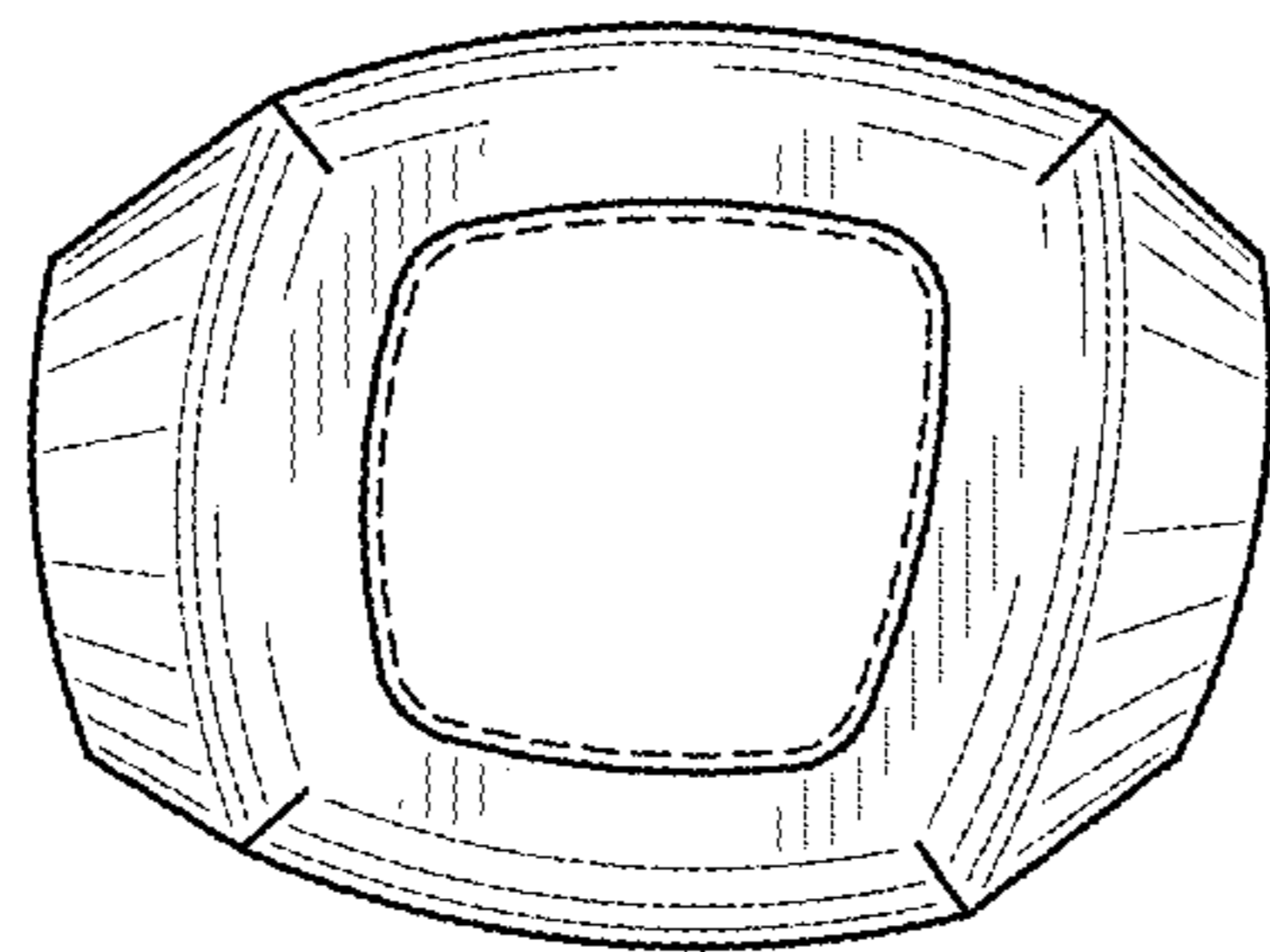

FIG. 7

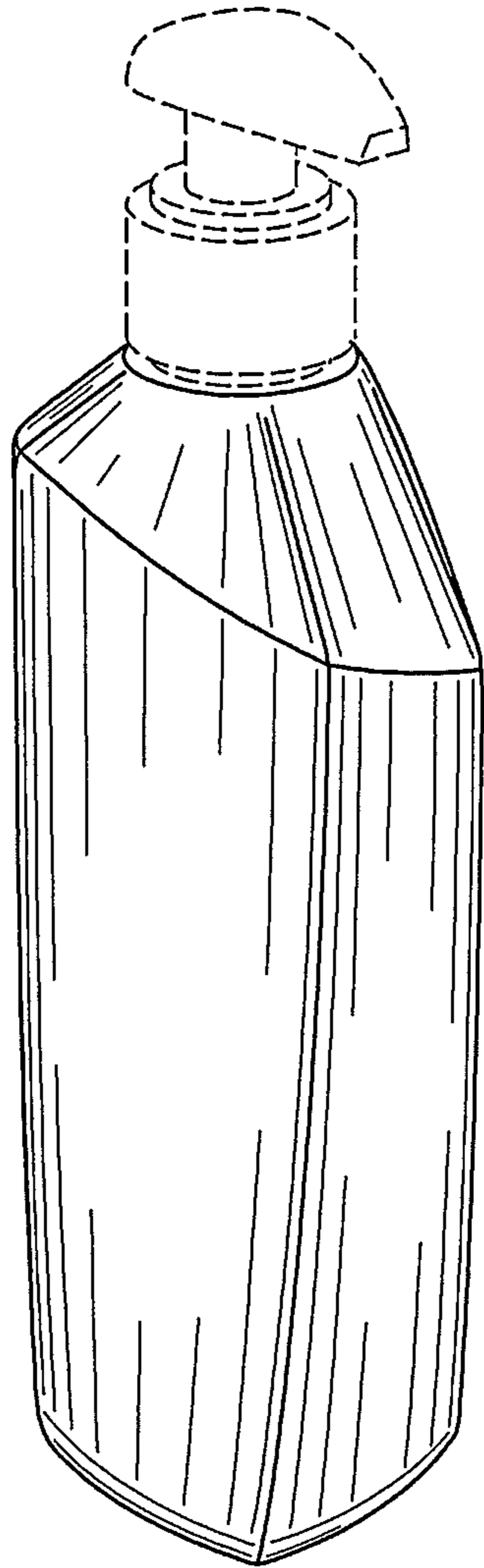

FIG. 8

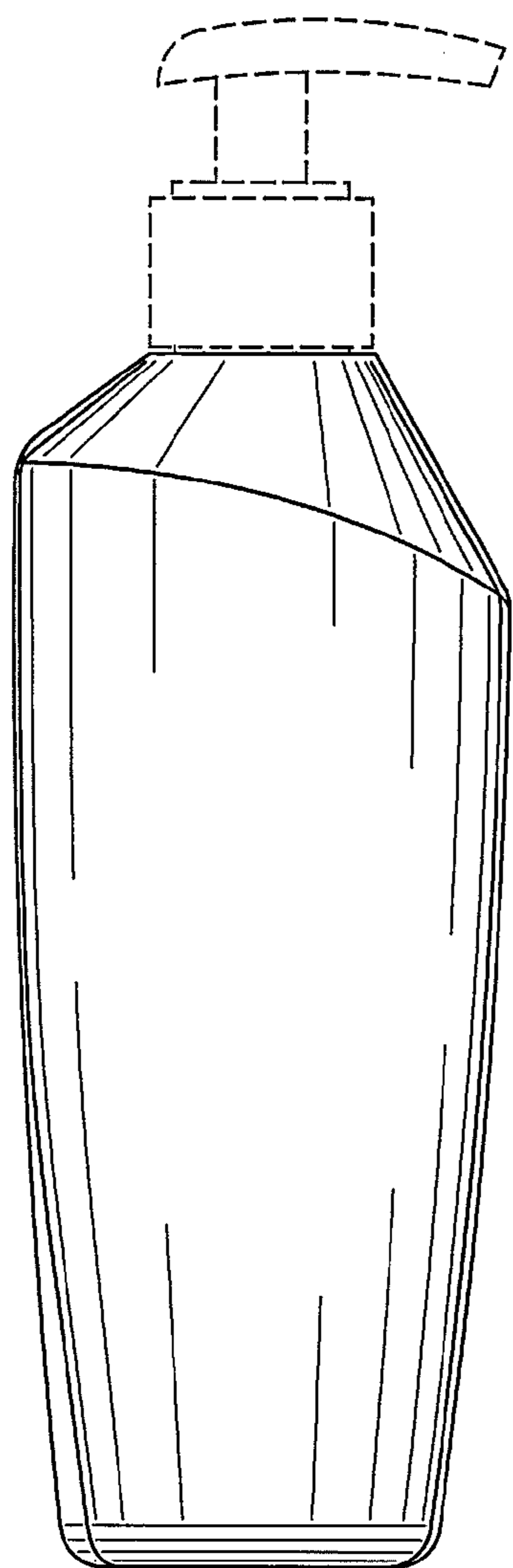

FIG. 9

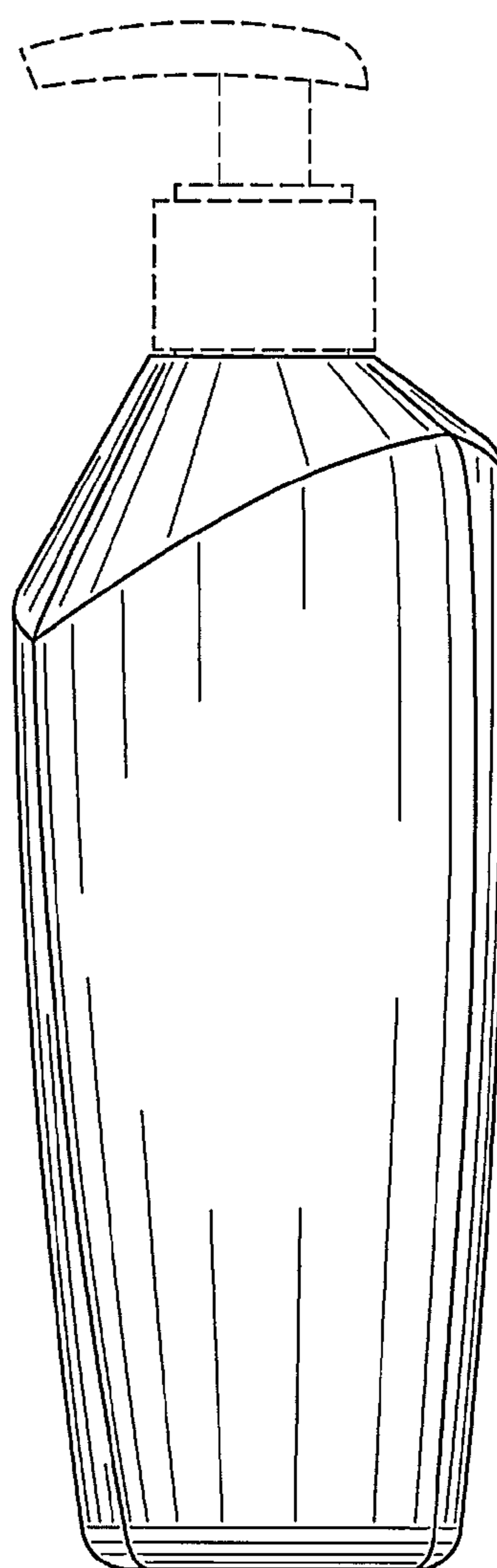

FIG. 10



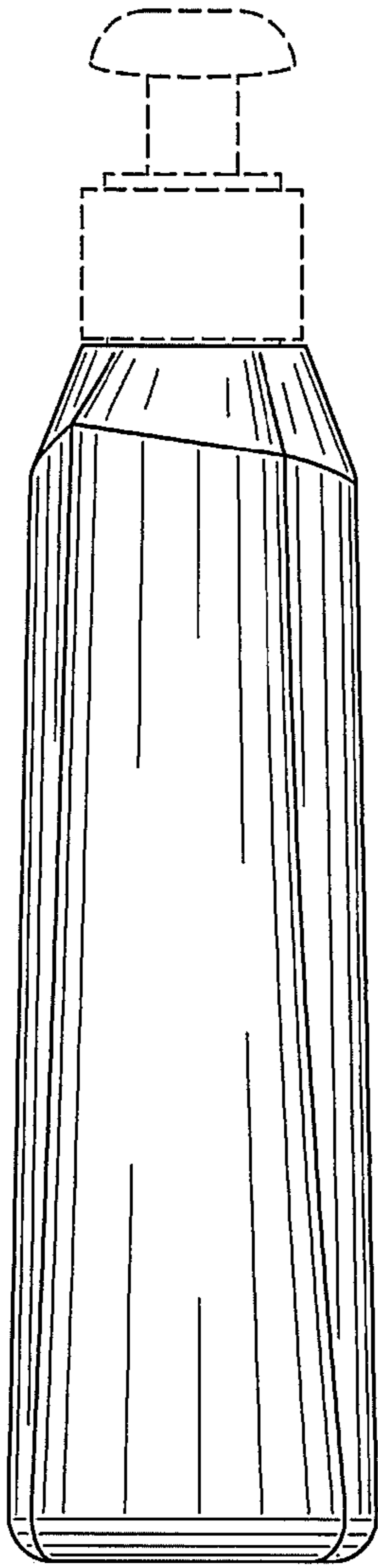

FIG. 11

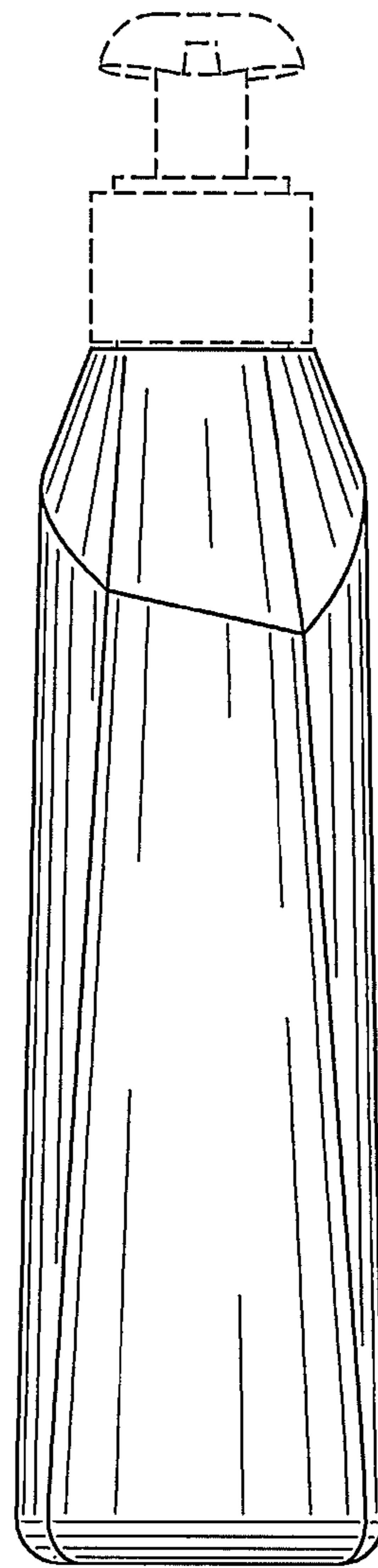

FIG. 12



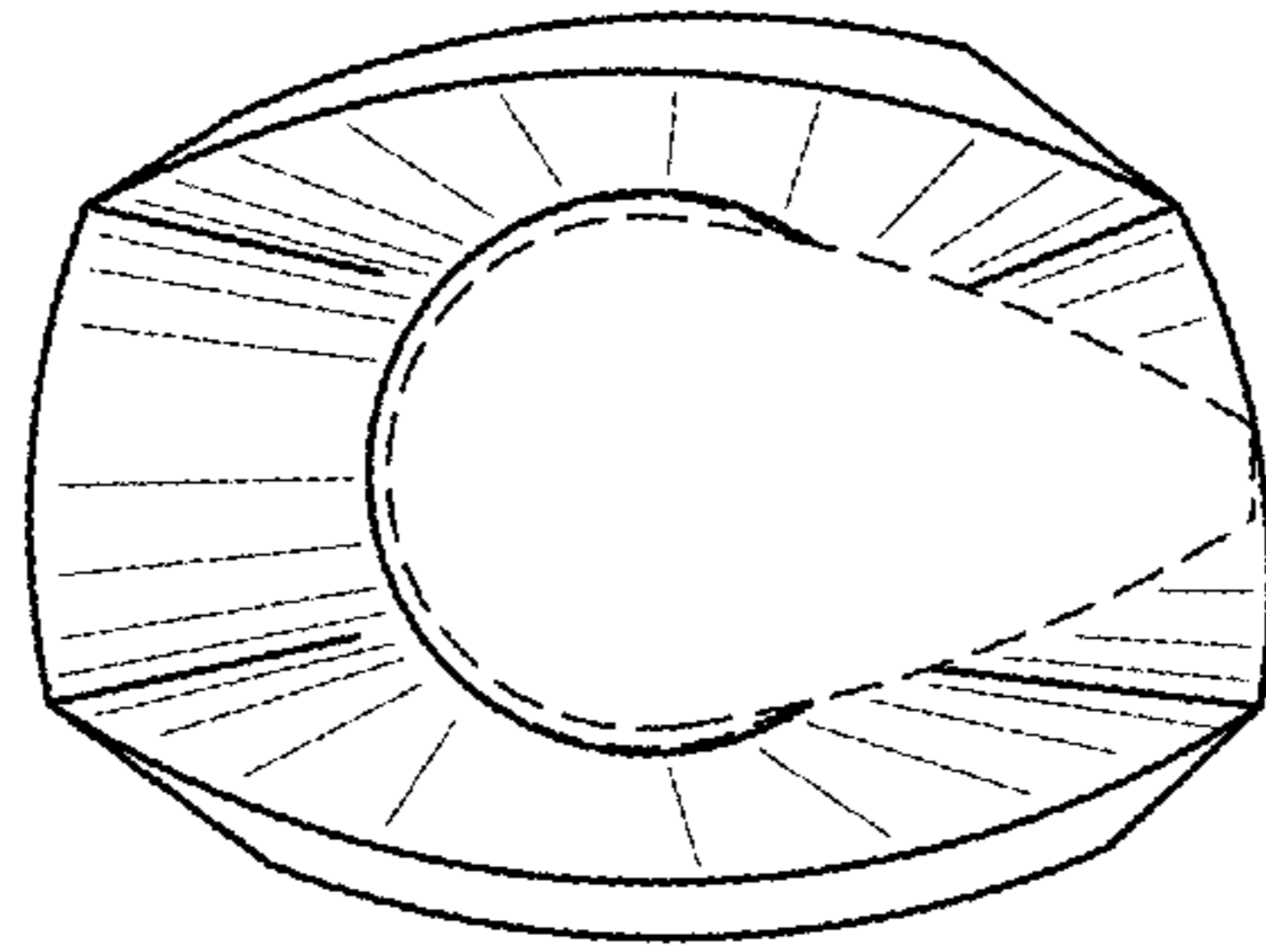

FIG. 13

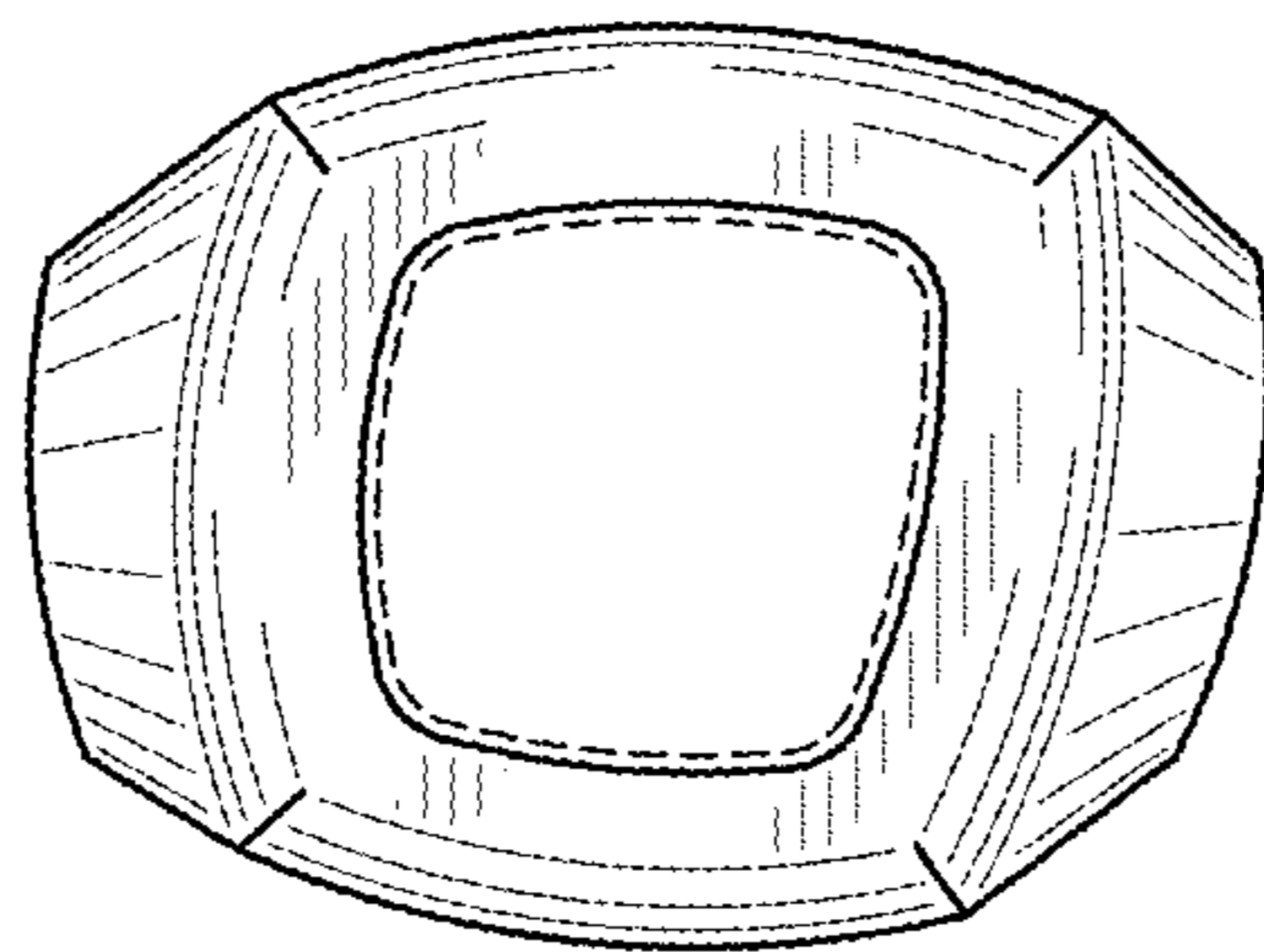

FIG. 14