



US00D739510S

(12) **United States Design Patent**  
**Bullock**

(10) **Patent No.:** **US D739,510 S**

(45) **Date of Patent:** **\*\* Sep. 22, 2015**

(54) **GREASE CONTAINMENT BUCKET**

6,041,824 A \* 3/2000 Powell ..... 138/109  
D425,600 S \* 5/2000 Pas et al. .... D22/136  
6,106,261 A \* 8/2000 von Holdt ..... 425/130

(71) Applicant: **Carl Jason Bullock**, Vienna, WV (US)

(Continued)

(72) Inventor: **Carl Jason Bullock**, Vienna, WV (US)

*Primary Examiner* — Eric Goodman

*Assistant Examiner* — Daniel J Domino

(\*\*) Term: **14 Years**

(74) *Attorney, Agent, or Firm* — Cahn & Samuels, LLP

(21) Appl. No.: **29/447,508**

(57) **CLAIM**

I claim the ornamental design for a grease containment bucket, as shown and described.

(22) Filed: **Mar. 4, 2013**

(51) **LOC (10) Cl.** ..... **23-01**

**DESCRIPTION**

(52) **U.S. Cl.**

USPC ..... **D23/268**

(58) **Field of Classification Search**

USPC ..... D23/205, 209, 260, 261, 266, 268;  
D7/601, 603; D9/532, 549, 558;  
D22/136, 199; D32/53, 53.1, 54;  
141/26, 86; 220/656, 672, 675, 904;  
15/264; 138/103, 121, 173

See application file for complete search history.

FIG. 1 is a first top perspective view of a grease containment bucket.

FIG. 2 is a second perspective top view of the new grease containment bucket design.

FIG. 3 is a perspective view showing the article in an alternate state of use with a lid.

FIG. 4 is a top perspective view of the article as shown in FIG. 3.

FIG. 5 is a side view of the front of the new grease containment bucket design.

FIG. 6 is a side view of a first side of new grease containment bucket design.

FIG. 7 is a side view of a second, opposite side of new grease containment bucket design.

FIG. 8 is a rear perspective view of the article as shown in FIG. 3.

FIG. 9 is a bottom view of the new grease containment bucket design.

FIG. 10 is an enlarged top perspective view of the interior of the grease containment bucket.

FIG. 11 is an alternative perspective view of the lower portion of FIG. 10.

FIG. 12 is another alternative perspective view of FIG. 10; and,

FIG. 13 is an enlarged perspective view of the interior element of the grease containment bucket.

The broken lines shown in the figures are for ease of illustrating enlarged or partial views.

(56) **References Cited**

U.S. PATENT DOCUMENTS

1,715,462	A *	6/1929	Manley	.....	141/26
3,804,289	A *	4/1974	Churan	.....	220/782
D235,101	S *	5/1975	Maroschak et al.	.....	D23/266
D235,104	S *	5/1975	Maroschak et al.	.....	D23/266
4,261,131	A *	4/1981	Poffenberger	.....	43/57
4,711,364	A *	12/1987	Letica	.....	220/276
D296,355	S *	6/1988	Kanao	.....	D23/266
D296,356	S *	6/1988	Kanao	.....	D23/266
D299,162	S *	12/1988	Fredblad	.....	D23/266
D307,790	S *	5/1990	Bjorkman et al.	.....	D23/266
5,277,227	A *	1/1994	Bradshaw et al.	.....	138/110
D350,900	S *	9/1994	Goetz	.....	D9/502
D352,143	S *	11/1994	Arshinoff	.....	D32/53
D364,017	S *	11/1995	Moffitt	.....	D32/53.1
5,512,073	A *	4/1996	Mirza et al.	.....	
5,727,599	A *	3/1998	Fisher et al.	.....	138/156
5,814,115	A *	9/1998	Allen et al.	.....	
D402,986	S *	12/1998	Doak	.....	D14/189
D419,735	S *	1/2000	Del Real	.....	D32/53
6,010,558	A *	1/2000	Ackland	.....	

**1 Claim, 6 Drawing Sheets**

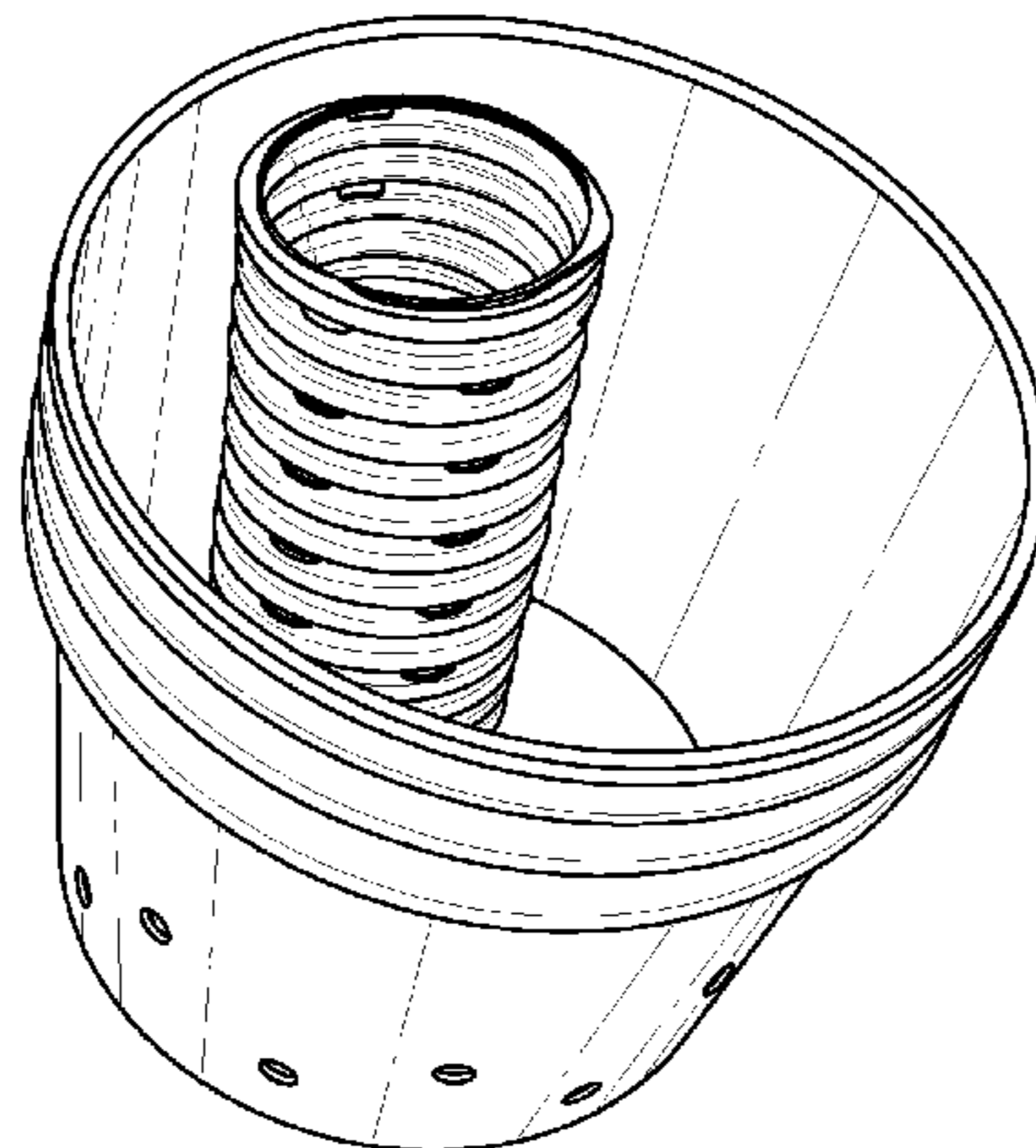

(56)

**References Cited**

U.S. PATENT DOCUMENTS

6,468,323 B1 10/2002 Chwala  
 6,648,937 B1 11/2003 Nguyen et al.  
 D493,929 S \* 8/2004 Schwarz ..... D32/53  
 7,037,359 B1 5/2006 McCauley  
 D545,519 S \* 6/2007 King ..... D32/53  
 RE40,577 E \* 11/2008 Renaud ..... D23/266  
 D590,561 S \* 4/2009 Baltz ..... D32/53  
 D591,406 S \* 4/2009 Crain ..... D23/266  
 D623,373 S \* 9/2010 Rockwell et al. .... D32/53  
 D631,219 S \* 1/2011 Rockwell et al. .... D32/53  
 D649,726 S \* 11/2011 Manuel ..... D32/53

D652,596 S \* 1/2012 Manuel ..... D32/53  
 D656,697 S \* 3/2012 McNeil ..... D32/53  
 D673,338 S \* 12/2012 Branham ..... D32/53  
 D688,592 S \* 8/2013 Placencia ..... D11/152  
 D709,263 S \* 7/2014 Carnesecca ..... D32/53  
 D722,474 S \* 2/2015 Seiders ..... D7/605  
 2006/0254663 A1 \* 11/2006 Renaud ..... 138/121  
 2007/0101986 A1 5/2007 Gilchrist  
 2007/0135031 A1 6/2007 Vlamis  
 2007/0295422 A1 \* 12/2007 Ostan et al. .... 138/121  
 2011/0151548 A1 6/2011 Clapp, III et al.  
 2012/0311972 A1 \* 12/2012 Hunter ..... 53/471  
 2013/0327184 A1 \* 12/2013 Nelson ..... 81/3.09

\* cited by examiner

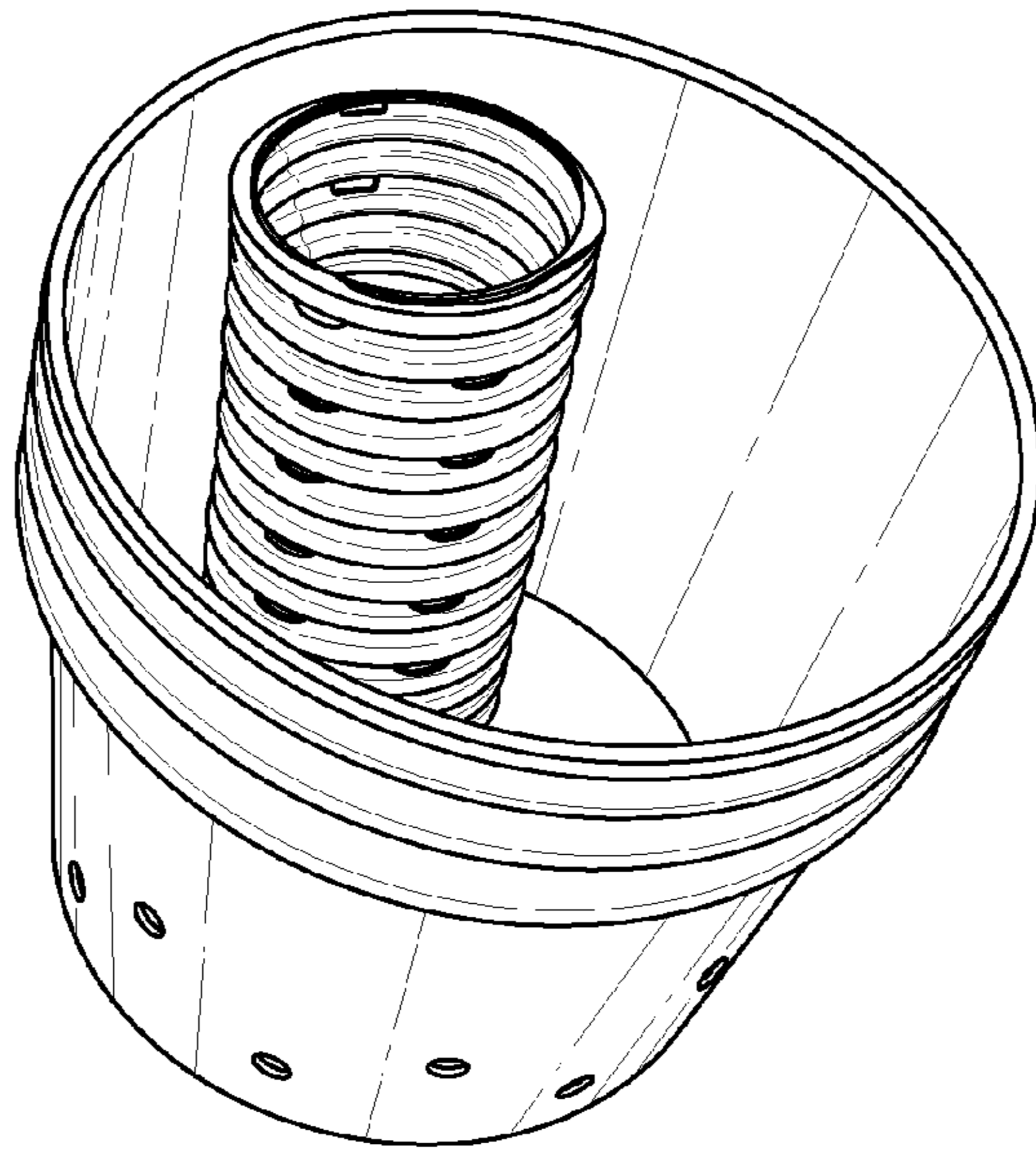

FIG. 1

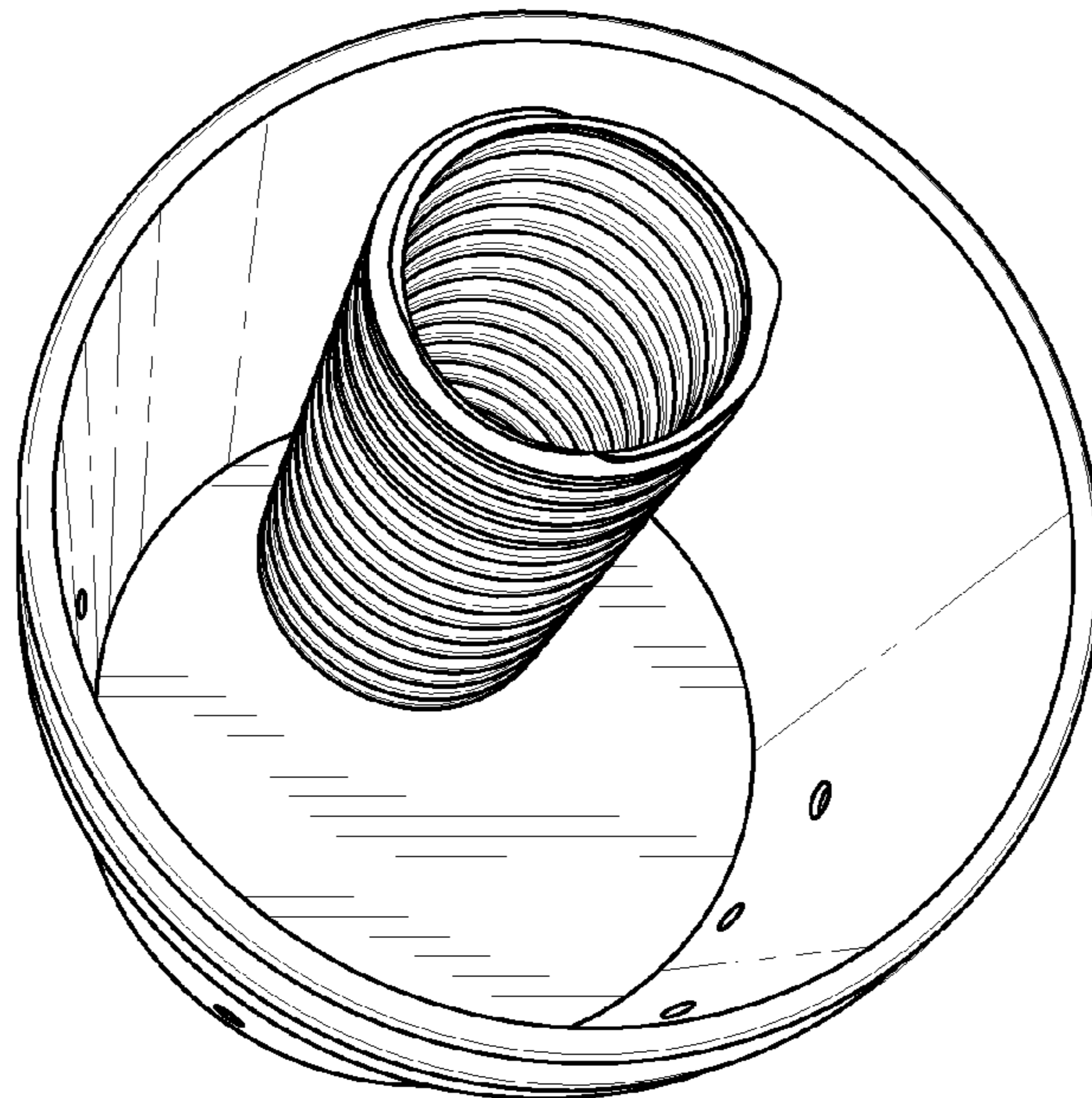

FIG. 2

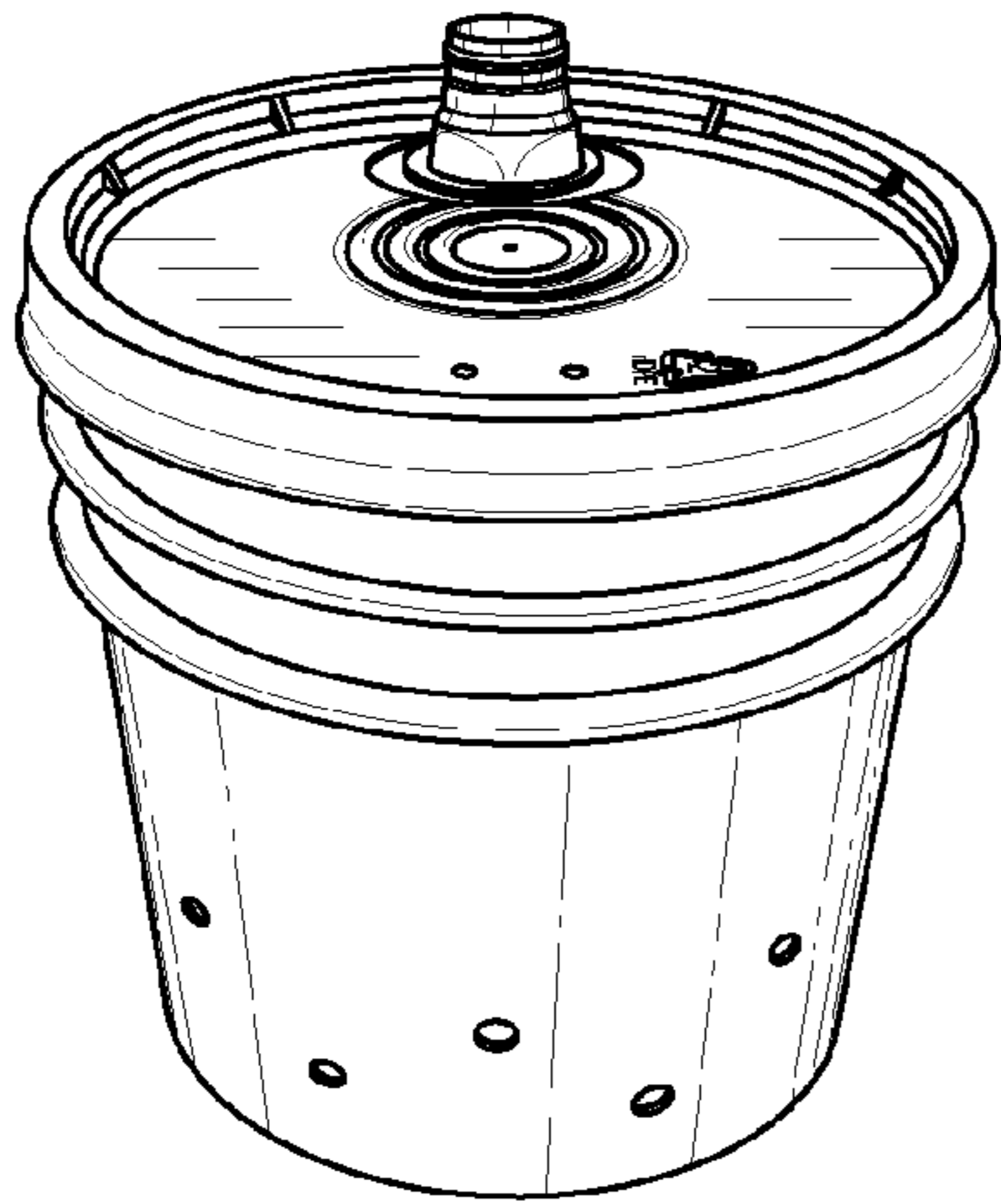

FIG. 3

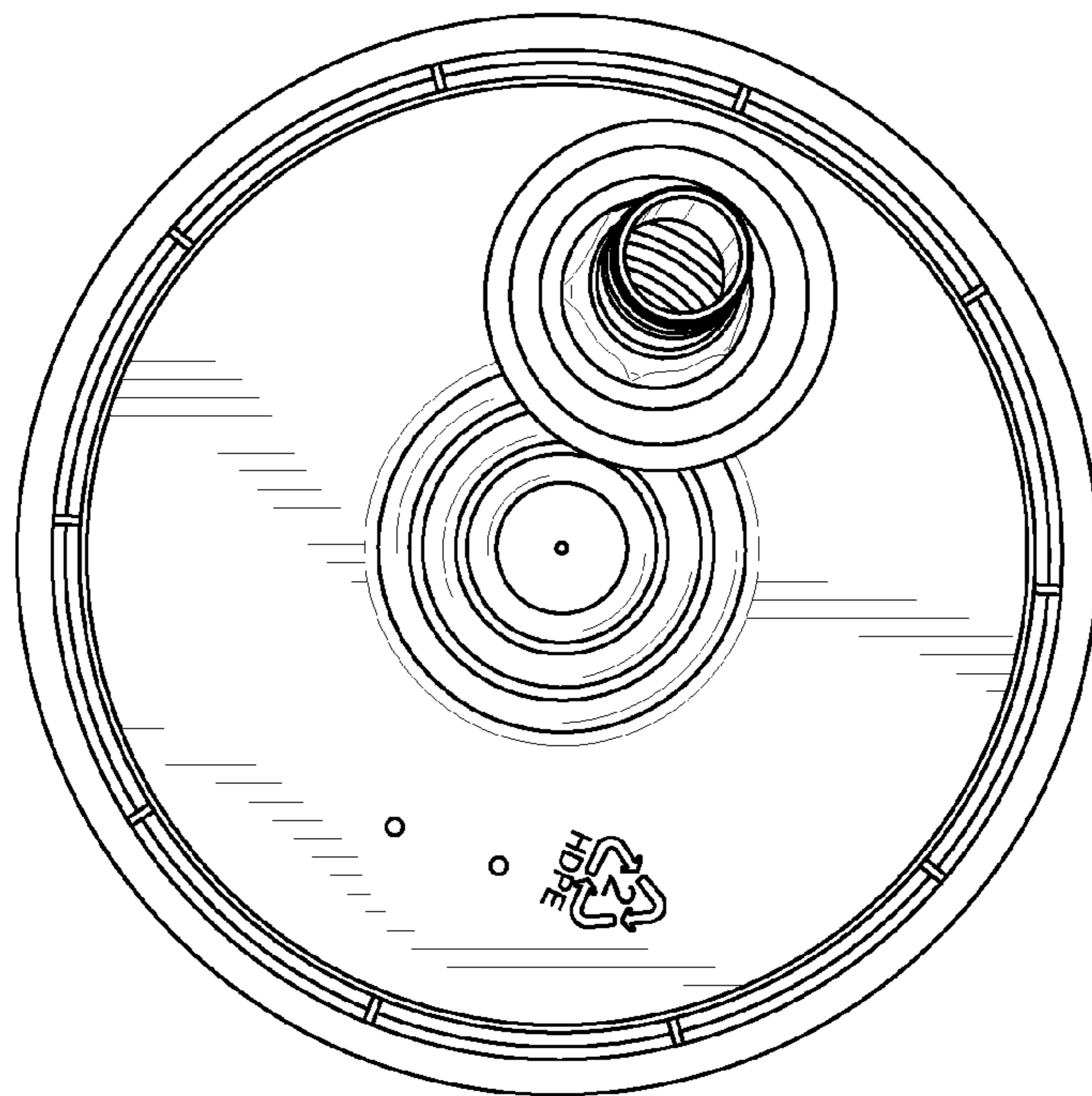

FIG. 4

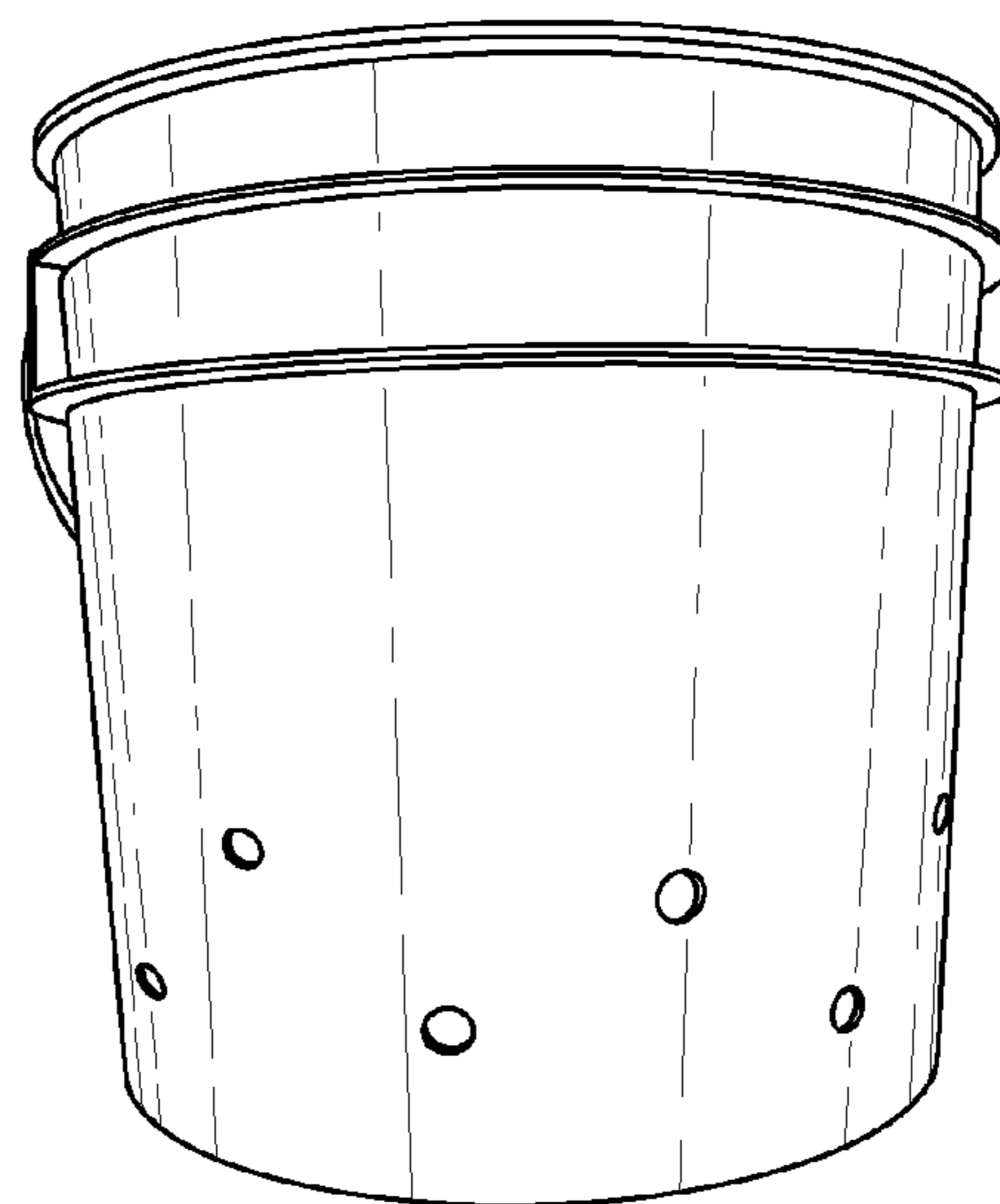

FIG. 5

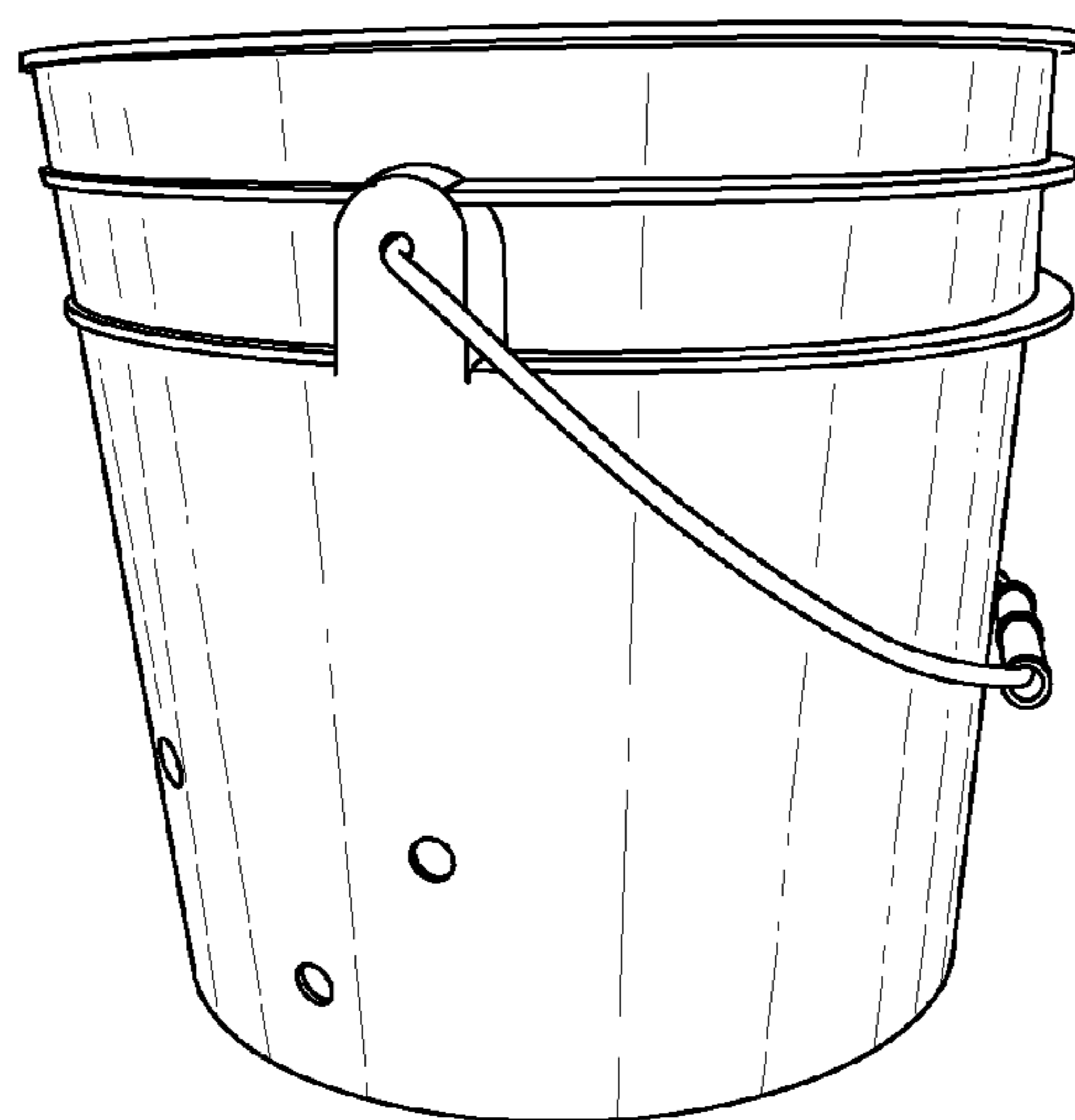

FIG. 6

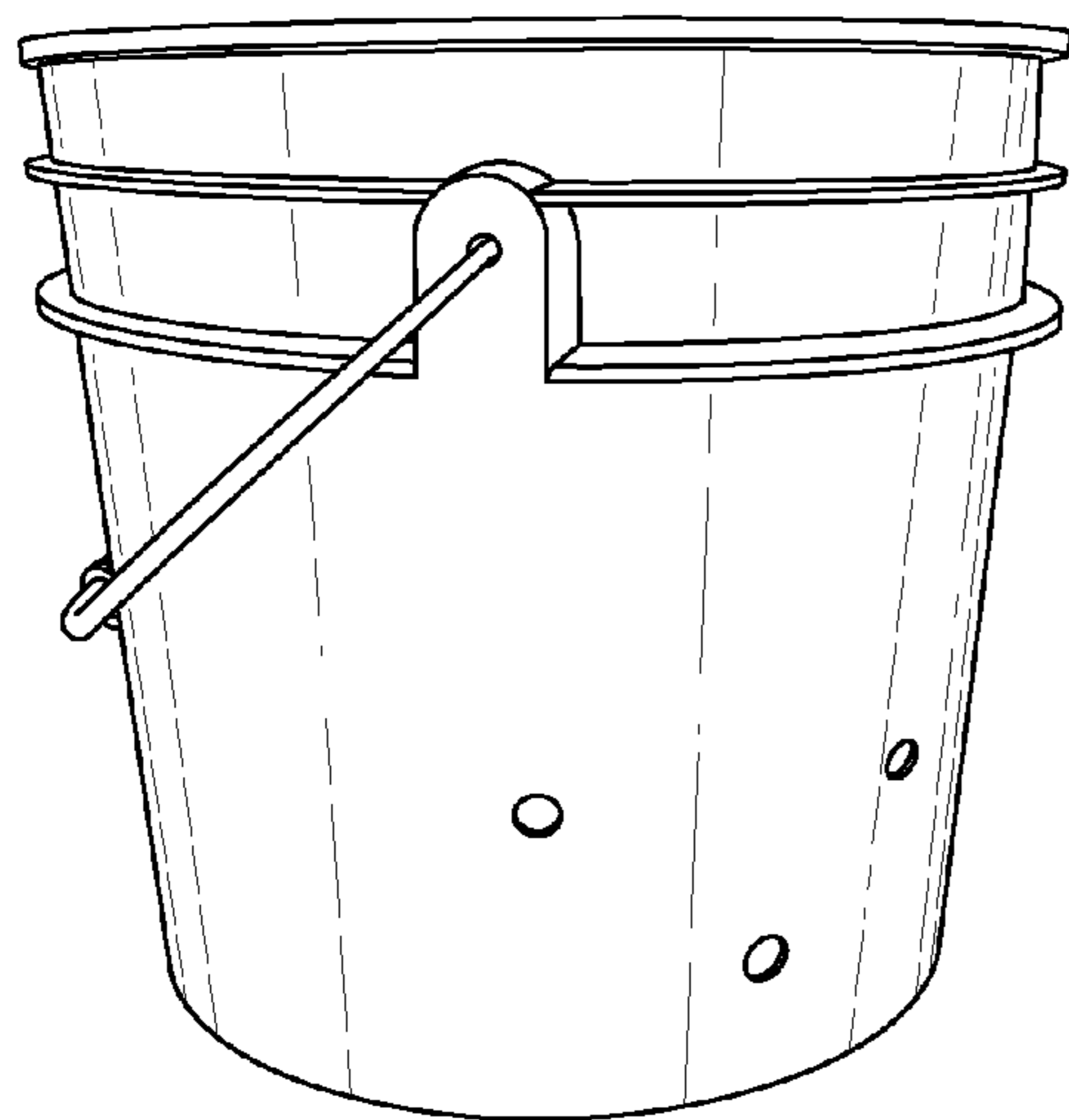

FIG. 7

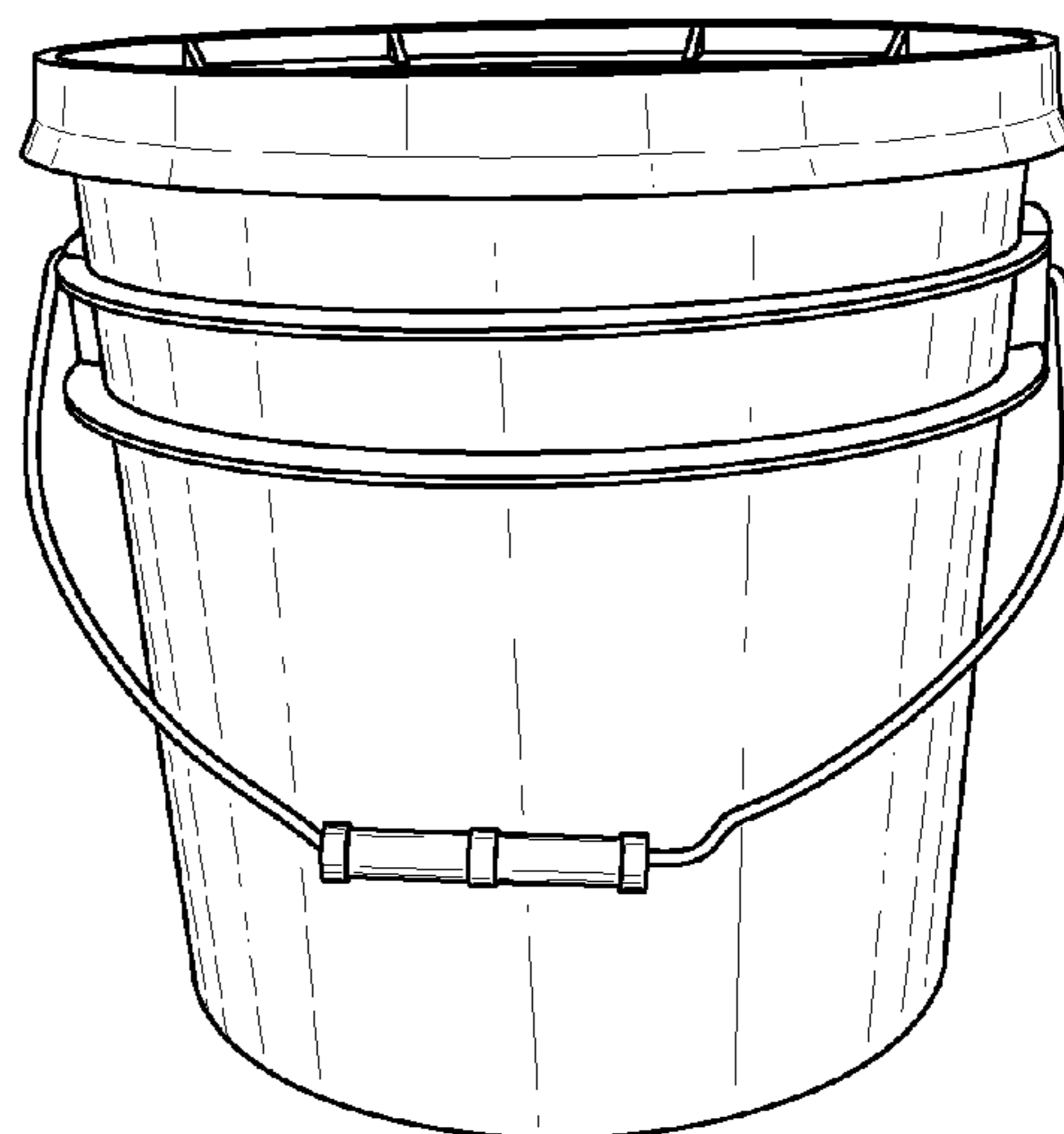

FIG. 8

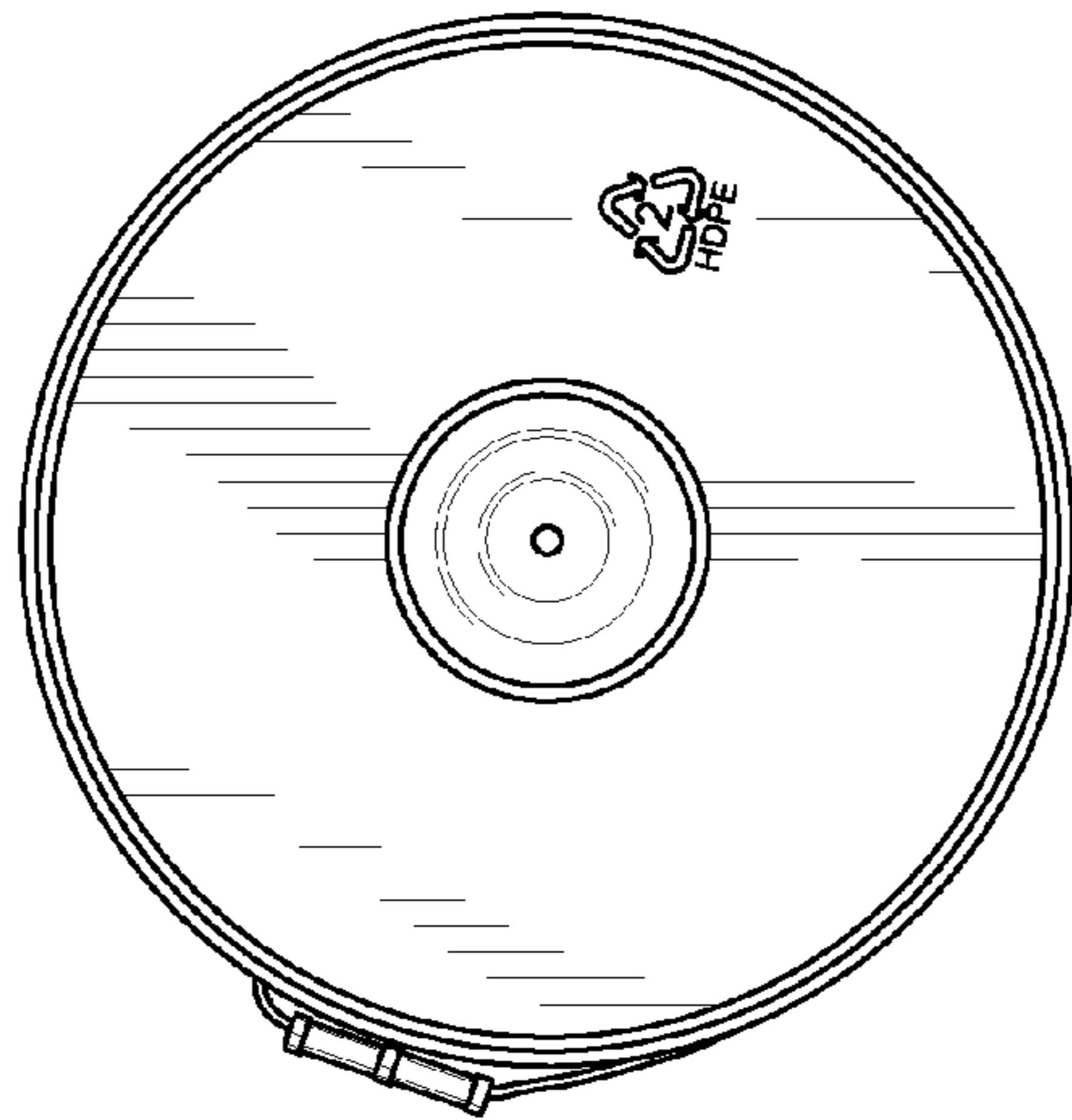

FIG. 9

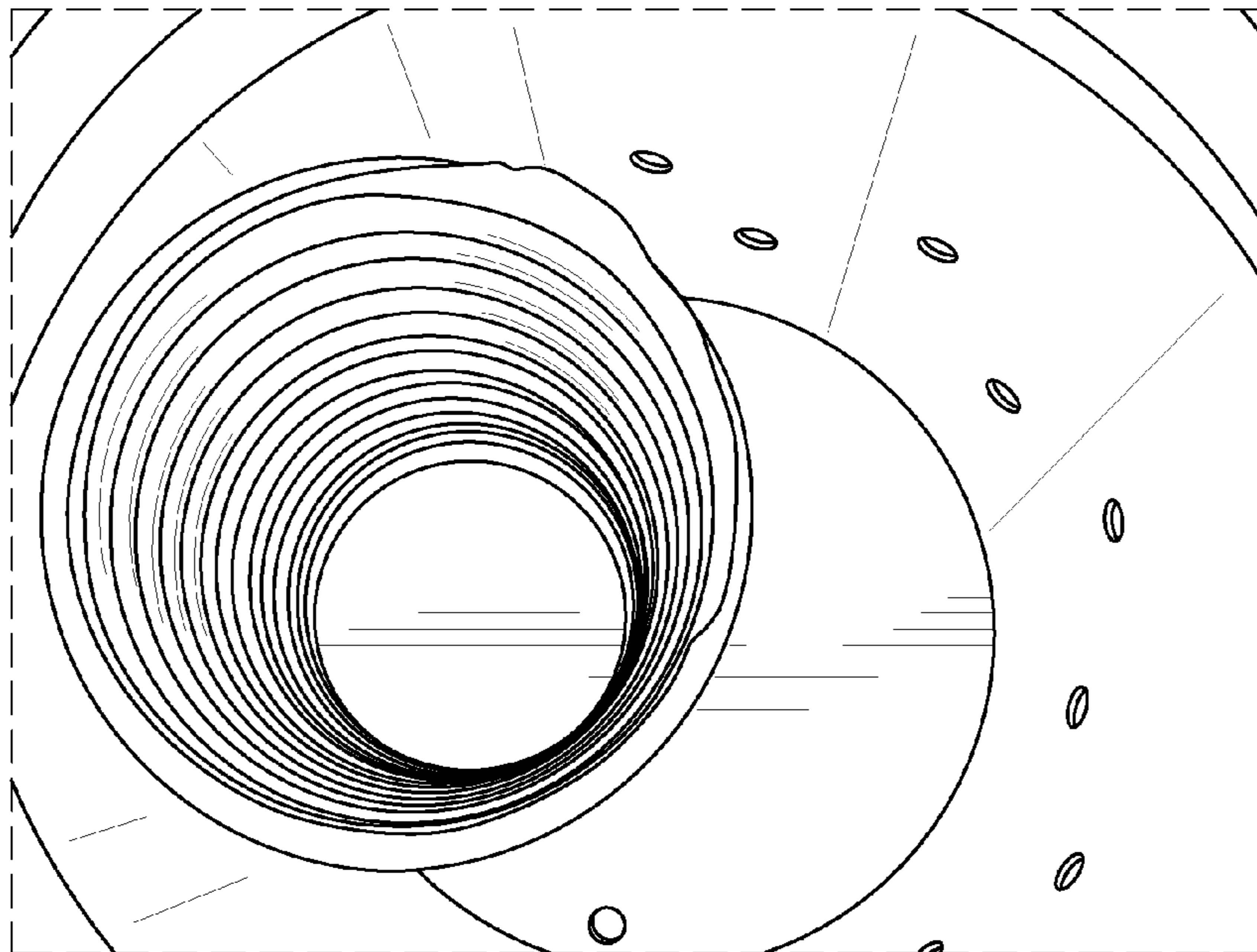

FIG. 10

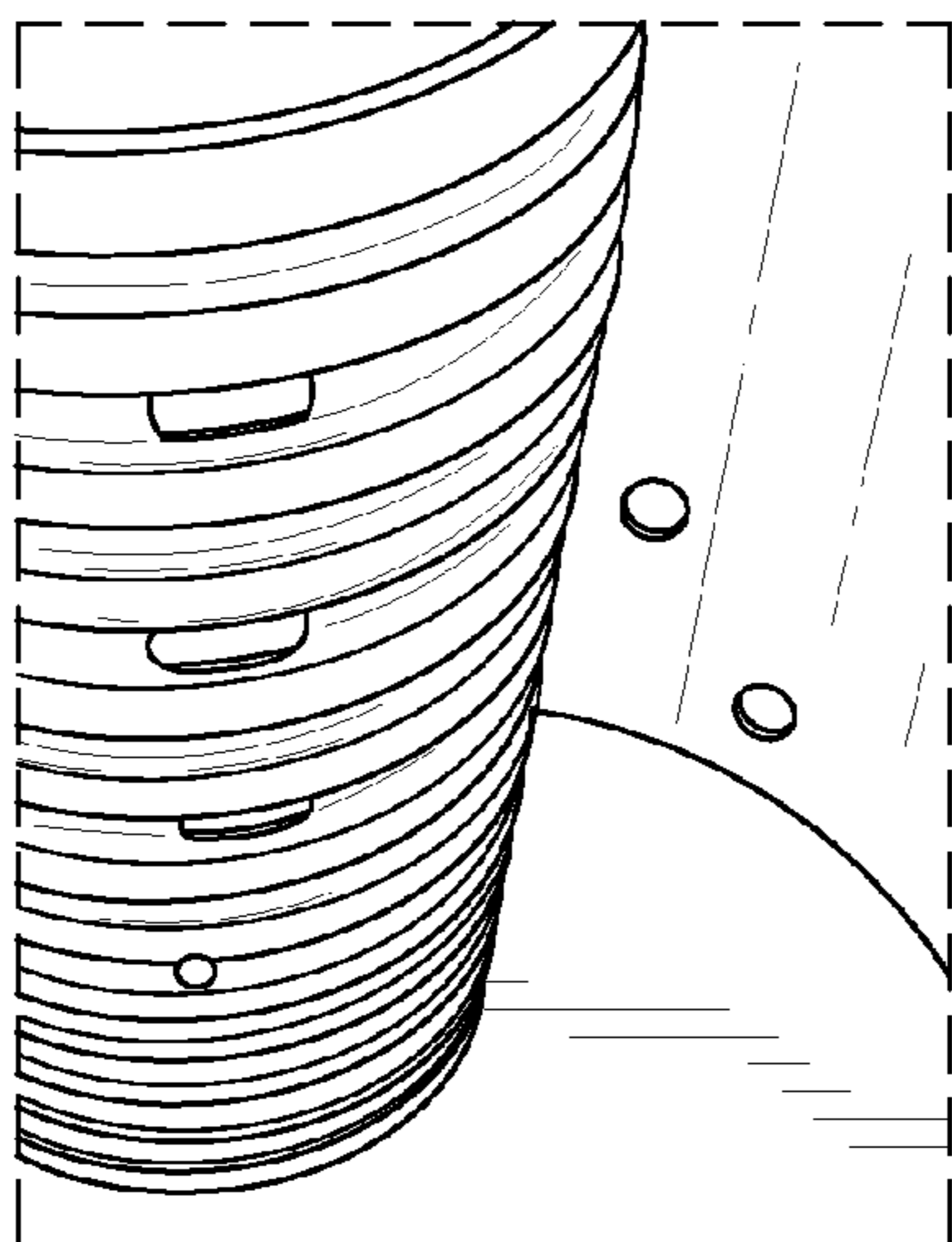

FIG. 11

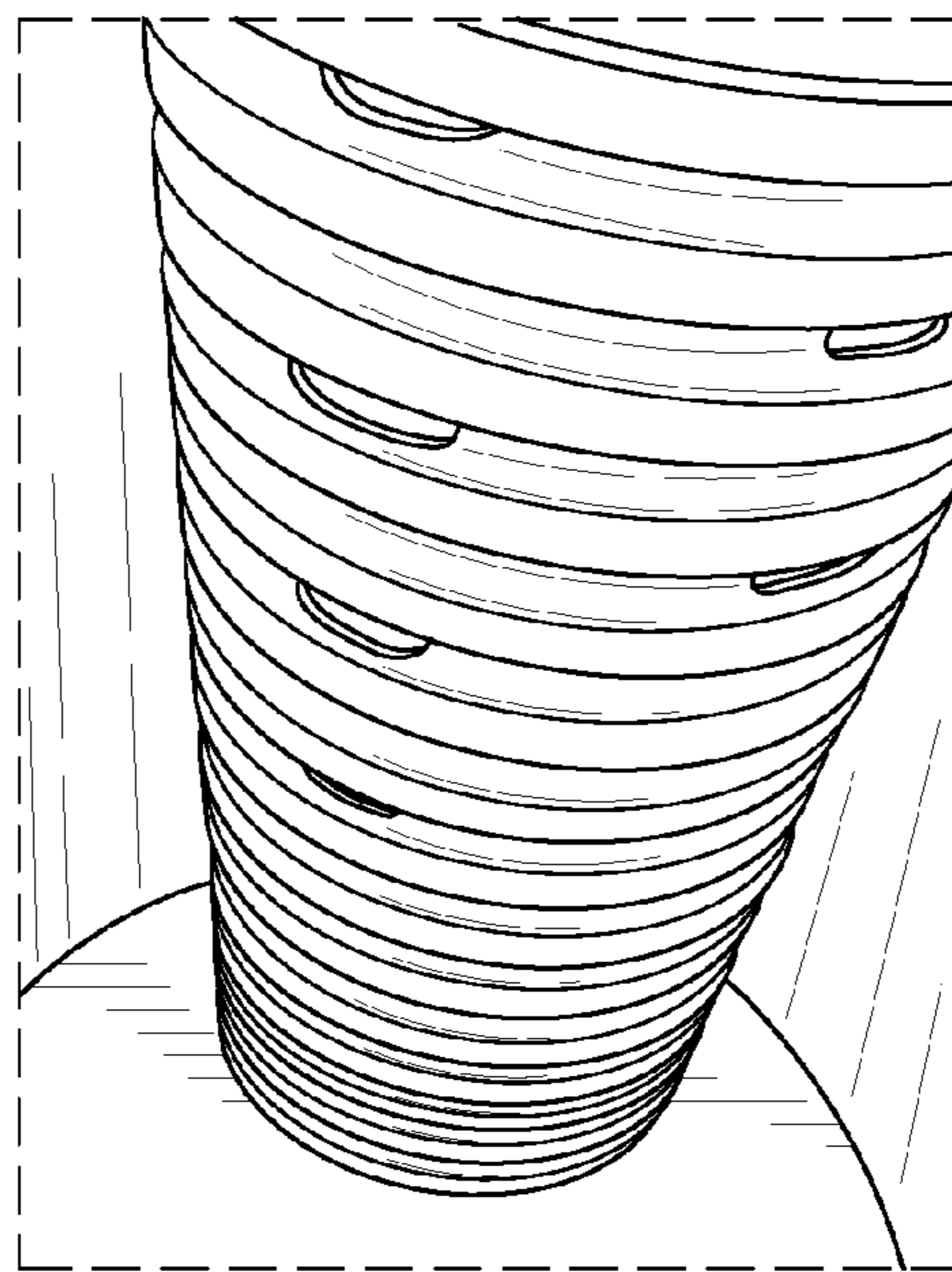

FIG. 12

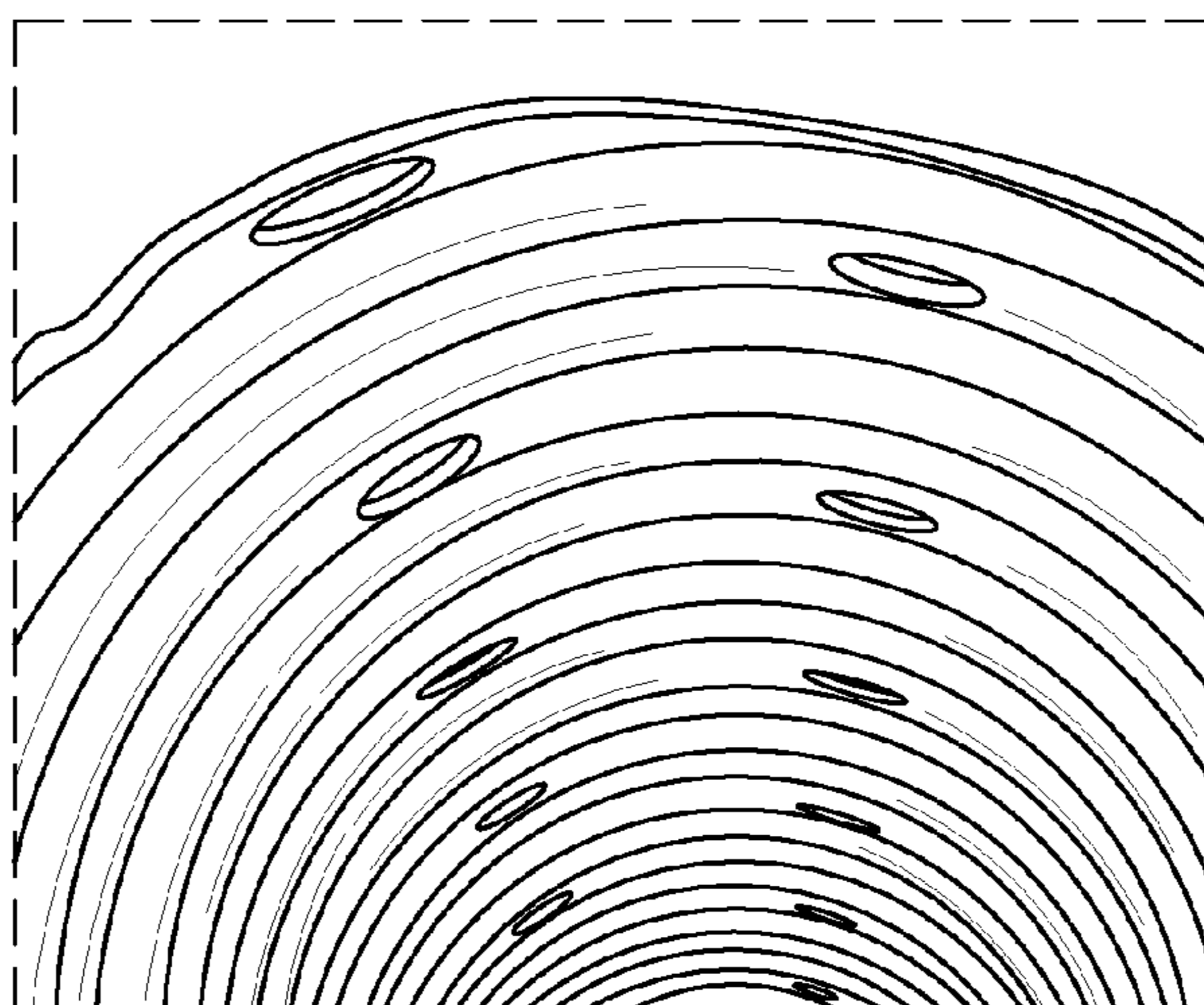

FIG. 13