



US00D739294S

(12) **United States Design Patent**
Davies et al.

(10) **Patent No.:** **US D739,294 S**
(45) **Date of Patent:** **** Sep. 22, 2015**

- (54) **GREENHOUSE POUCH**
- (71) Applicant: **United Source Packaging LLC**,
Vancouver, WA (US)
- (72) Inventors: **Edward Davies**, Pleasanton, CA (US);
Leonard Parker, San Clemente, CA
(US)
- (73) Assignee: **United Source Packaging LLC**,
Vancouver, WA (US)
- (**) Term: **14 Years**
- (21) Appl. No.: **29/502,769**
- (22) Filed: **Sep. 19, 2014**
- (51) **LOC (10) Cl.** **11-02**
- (52) **U.S. Cl.**
USPC **D11/145**
- (58) **Field of Classification Search**
USPC D6/403-405, 675, 683; D11/143-156,
D11/164; D9/415, 425, 702, 703, 707;
D25/15, 25
CPC A01G 9/00; A01G 9/02; A01G 9/021;
A01G 9/022; A01G 9/024; A01G 9/10;
A01G 9/04; A01G 9/042; A01G 9/14; A01G
9/16; A01G 31/02; B65D 33/02
See application file for complete search history.

3,961,442 A *	6/1976	Carter	52/86
D246,096 S *	10/1977	Trumley	D11/145
4,064,648 A *	12/1977	Cary	47/17
4,086,876 A *	5/1978	Moore et al.	119/246
D267,904 S *	2/1983	Hampel et al.	D30/108
4,438,680 A *	3/1984	Esposito	454/341
4,699,316 A *	10/1987	Johnson	237/69
5,479,744 A *	1/1996	Meyer	52/63
5,660,002 A *	8/1997	Lashinger	52/63
5,956,896 A *	9/1999	Miekka et al.	47/58.1 R
6,098,335 A *	8/2000	Brown, Jr.	47/17
D440,903 S *	4/2001	Gingerella	D11/145
6,213,645 B1 *	4/2001	Beer	383/211
6,442,903 B1 *	9/2002	Hebert	52/2.11
D527,278 S *	8/2006	Ueda	D9/702
7,676,994 B2 *	3/2010	Liang	52/63

(Continued)

OTHER PUBLICATIONS

Chantler Packaging, Chantler packaging announces the new EnduroPouch(TM), Mar. 14, 2014 (web page).

(Continued)

Primary Examiner — Elizabeth Albert
(74) *Attorney, Agent, or Firm* — Silicon Edge Law Group LLP; Mark P. Guidotti

(57) **CLAIM**
The ornamental design for a greenhouse pouch, as shown and described.

DESCRIPTION

FIG. 1 is a perspective view of a greenhouse pouch showing our new design;
FIG. 2 is a top view thereof;
FIG. 3 is a bottom view thereof;
FIG. 4 is a rear view thereof;
FIG. 5 is a front view thereof;
FIG. 6 is a left side view thereof; and,
FIG. 7 is a right side view thereof.

1 Claim, 7 Drawing Sheets

(56) **References Cited**
U.S. PATENT DOCUMENTS

1,897,062 A *	2/1933	Liermann	47/17
D138,728 S *	9/1944	King	D25/15
D165,256 S *	11/1951	Yellin	D9/425
2,709,838 A *	6/1955	Zausner	47/17
D185,789 S *	8/1959	Mims	D25/15
2,963,819 A *	12/1960	Hoch	47/17
3,462,061 A *	8/1969	Shore	229/103.1
D228,450 S *	9/1973	Flickinger	D25/15
D239,170 S *	3/1976	Hansen	D25/15

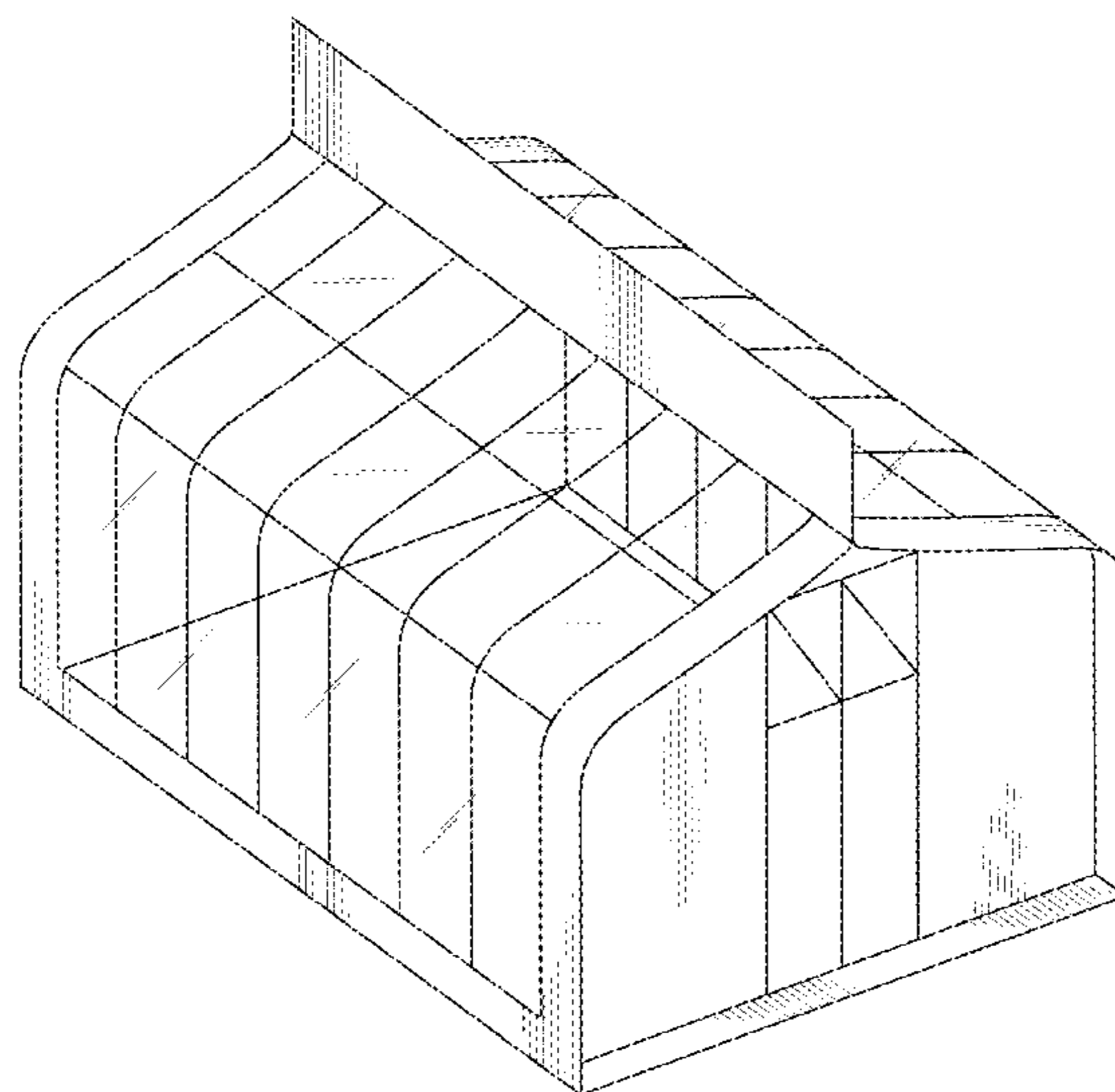

(56)

References Cited

U.S. PATENT DOCUMENTS

8,277,121 B2 * 10/2012 Bell et al. 383/210
2008/0060280 A1 * 3/2008 Iandimarino 52/3

OTHER PUBLICATIONS

FIMAT SRL, *fi*mat Un vestito su misura per i Vostri prodotti (“*fi*mat A tailored suit for your products”), 2011 (web page, Italian).

FIMAT SRL, *fi*mat Un vestito su misura per i Vostri prodotti (“*fi*mat A tailored suit for your products”), 2011 (web page, EN translation of NPL 2).

Global Foodmate, New vertically filled fruit and vegetable packaging with a handle, Dec. 17, 2012 (web page).

Robbie Fantastic Flexibles, Produce Bags and Pouches, undated (retrieved Dec. 1, 2014) (web page).

* cited by examiner

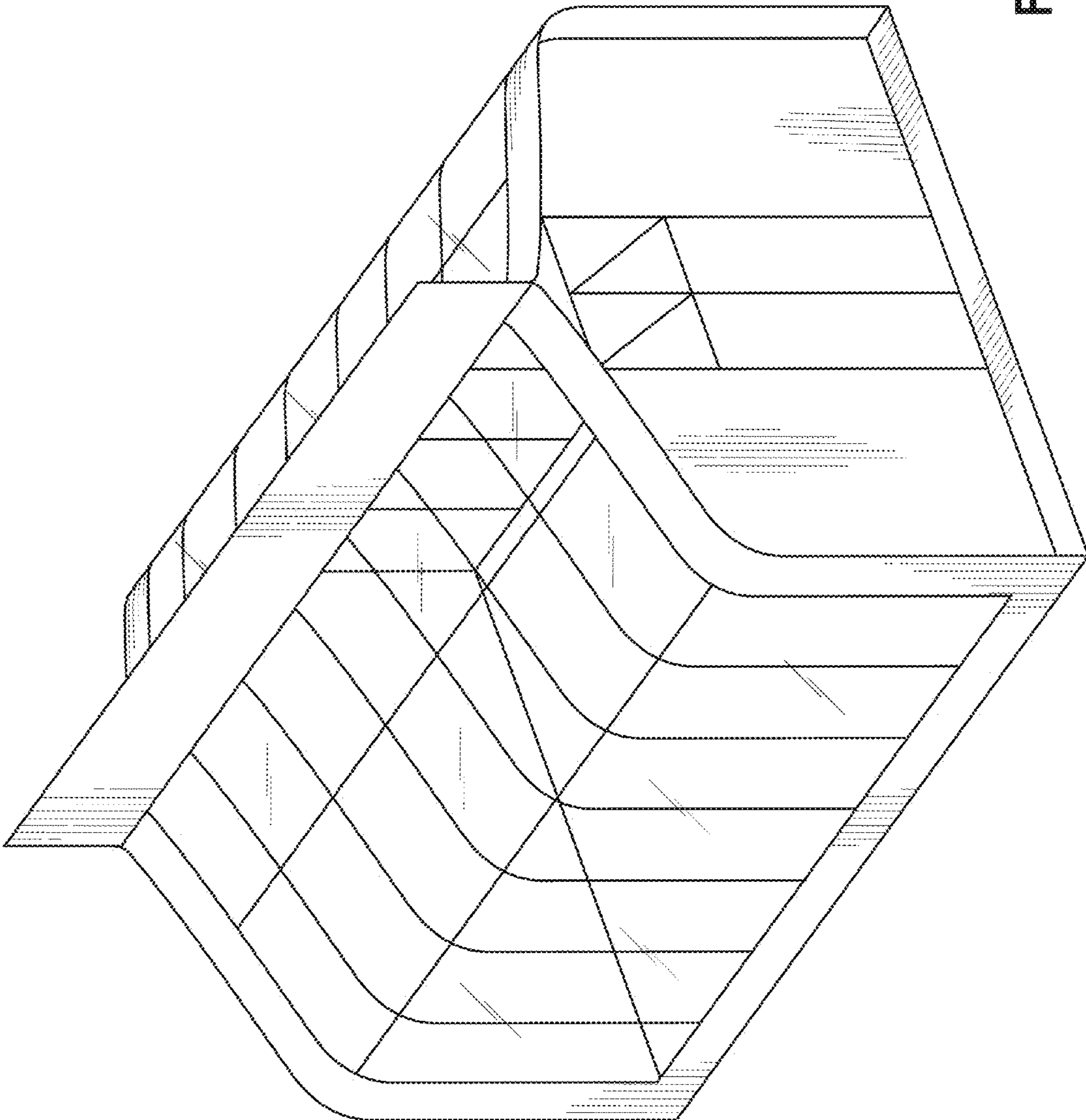

FIG. 1

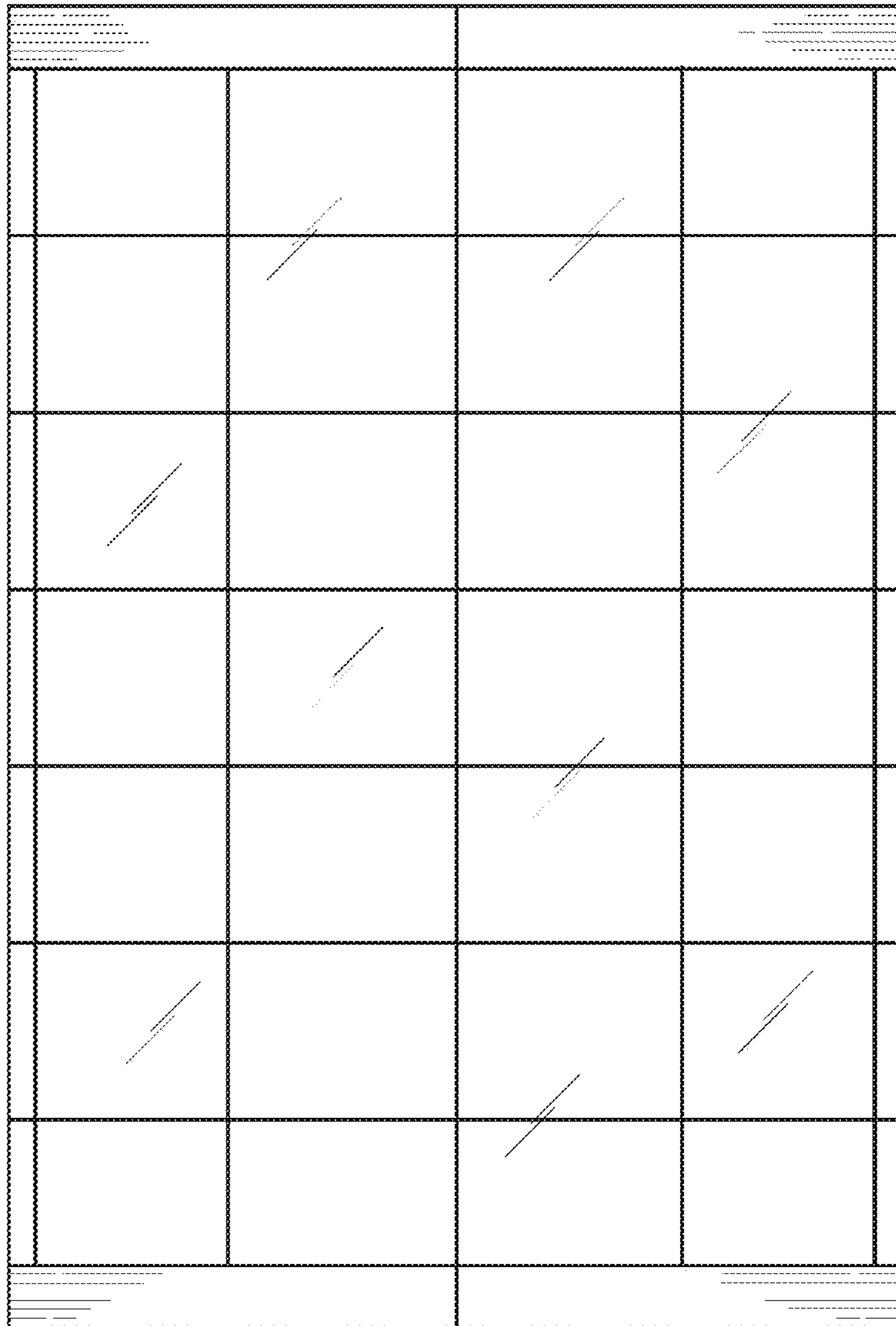

FIG. 2

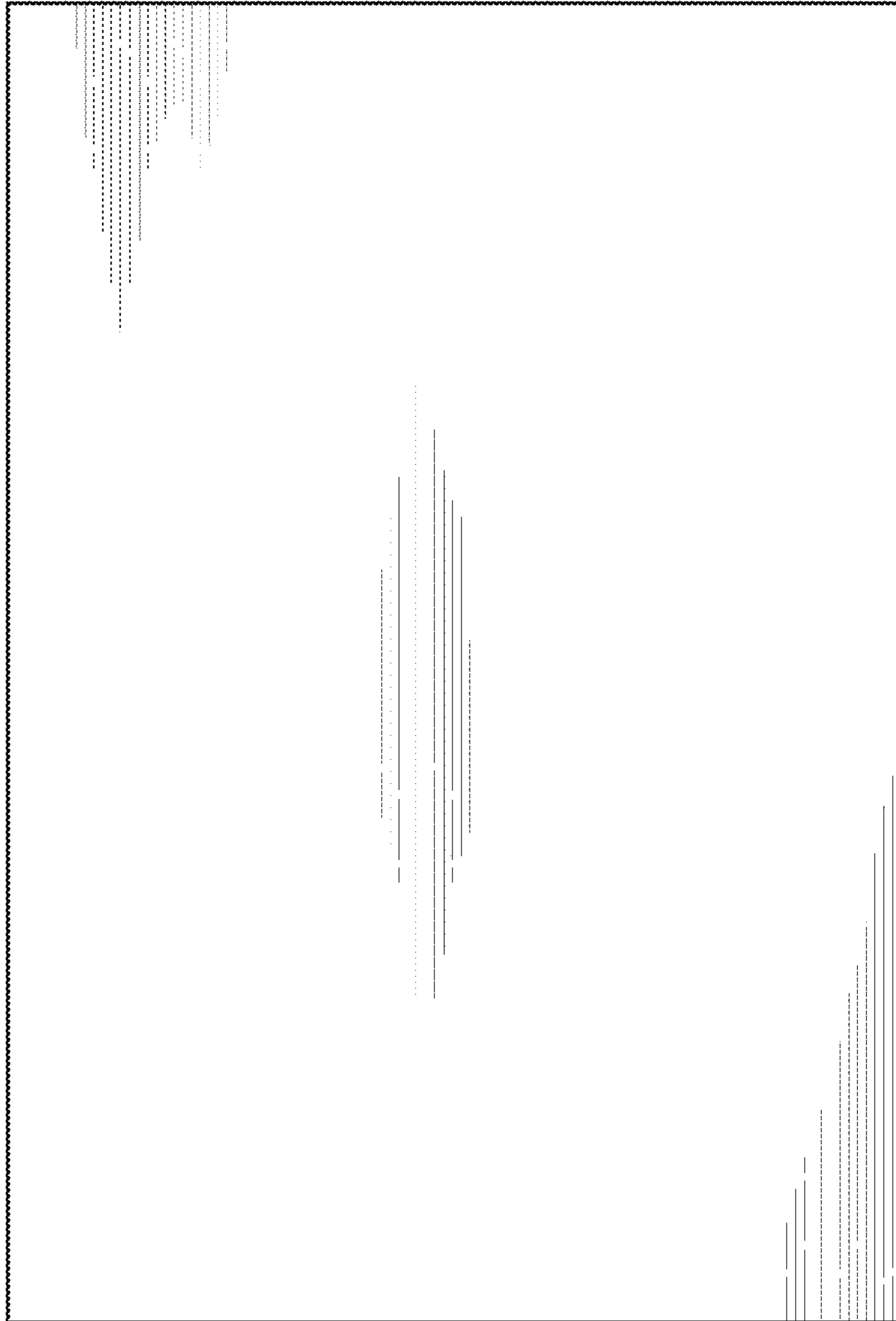

FIG. 3

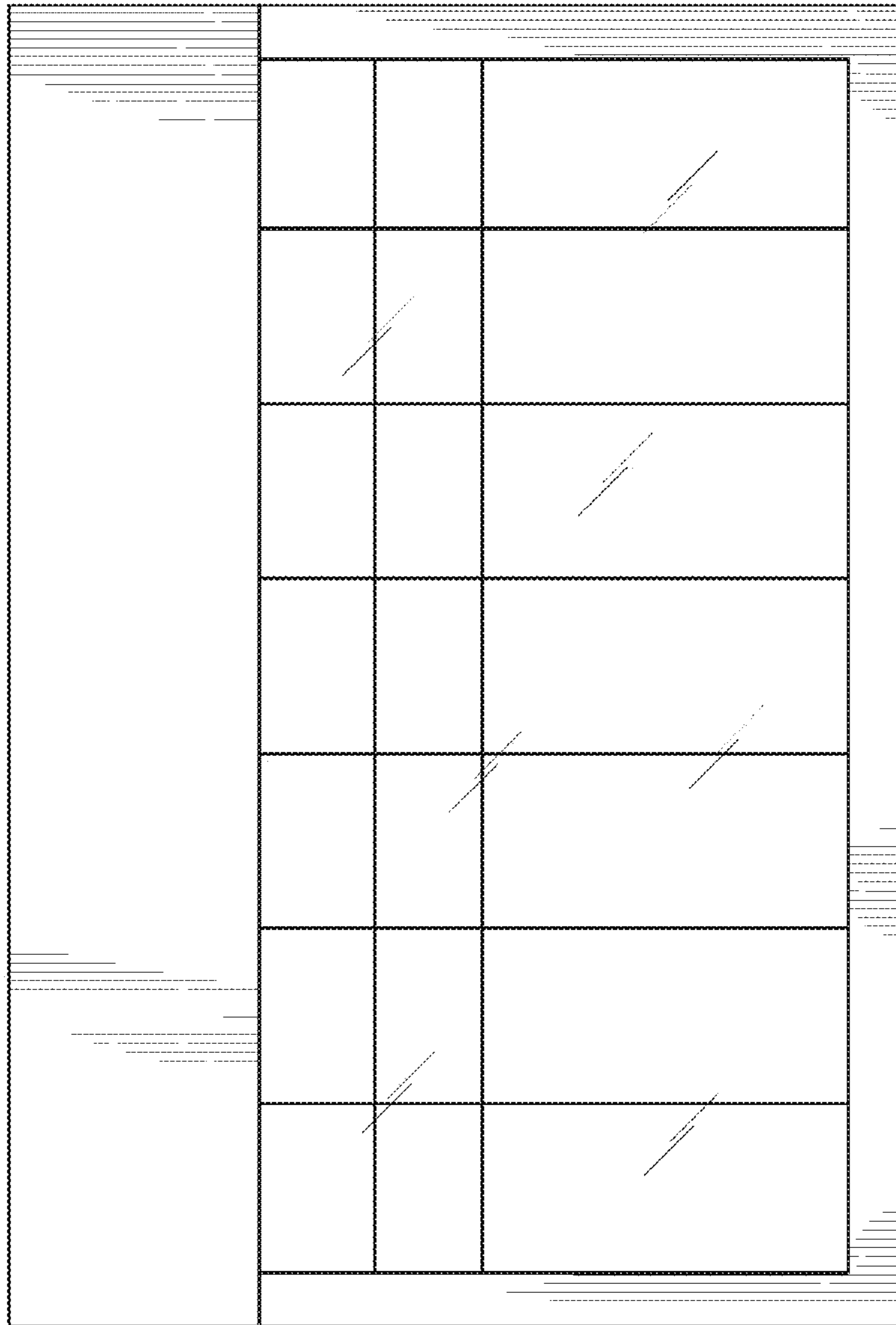

FIG. 4

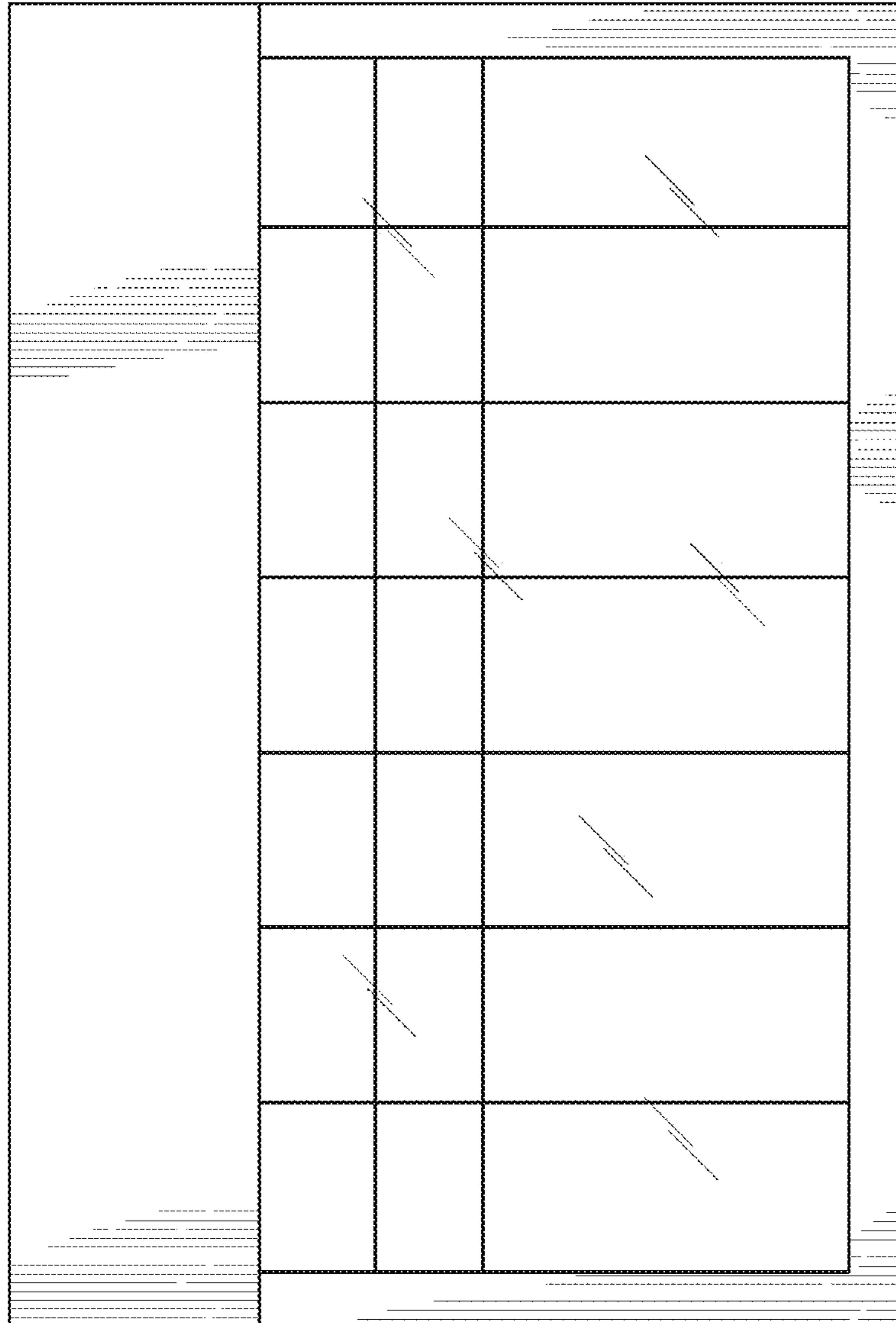

FIG. 5

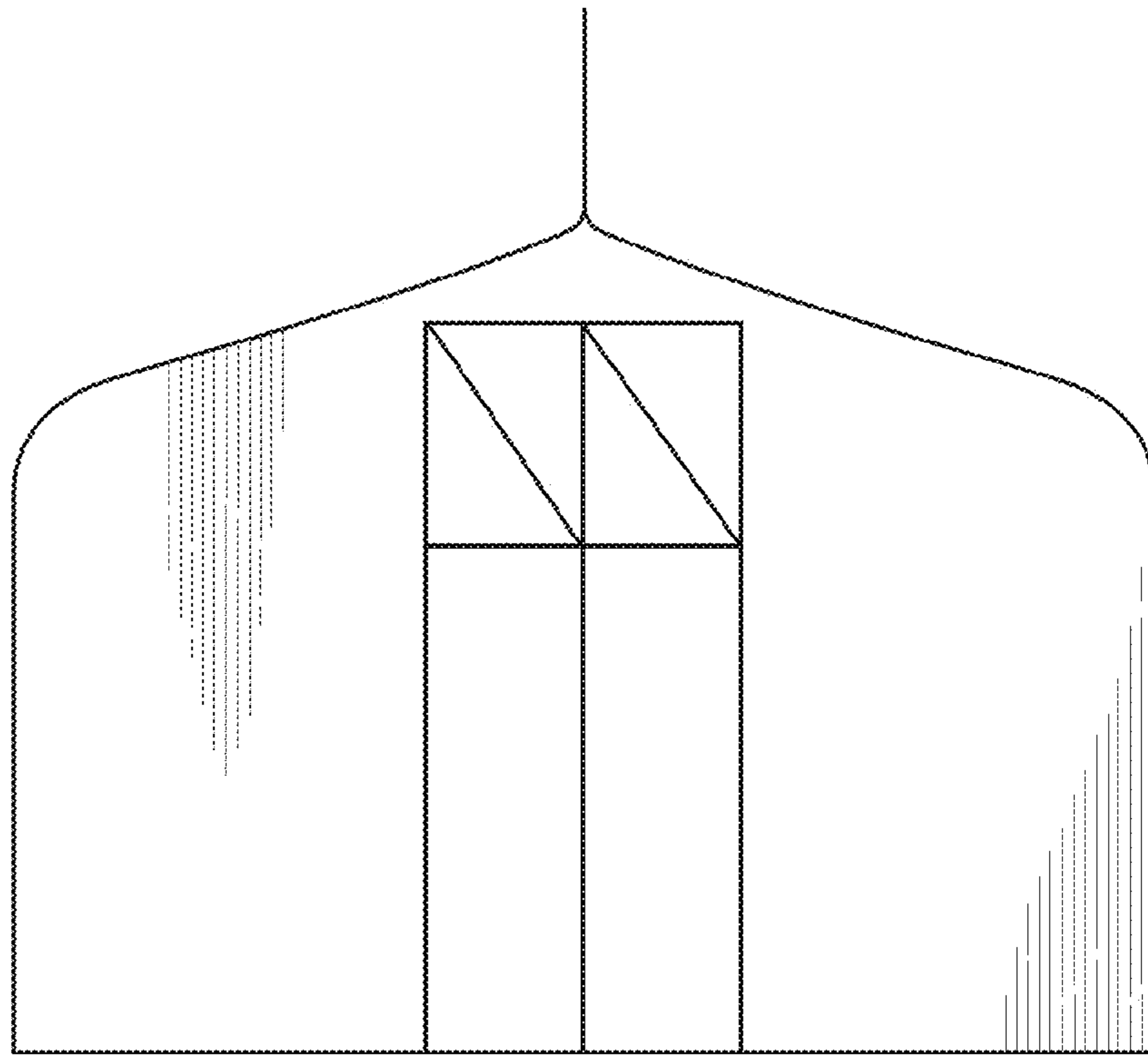

FIG. 6

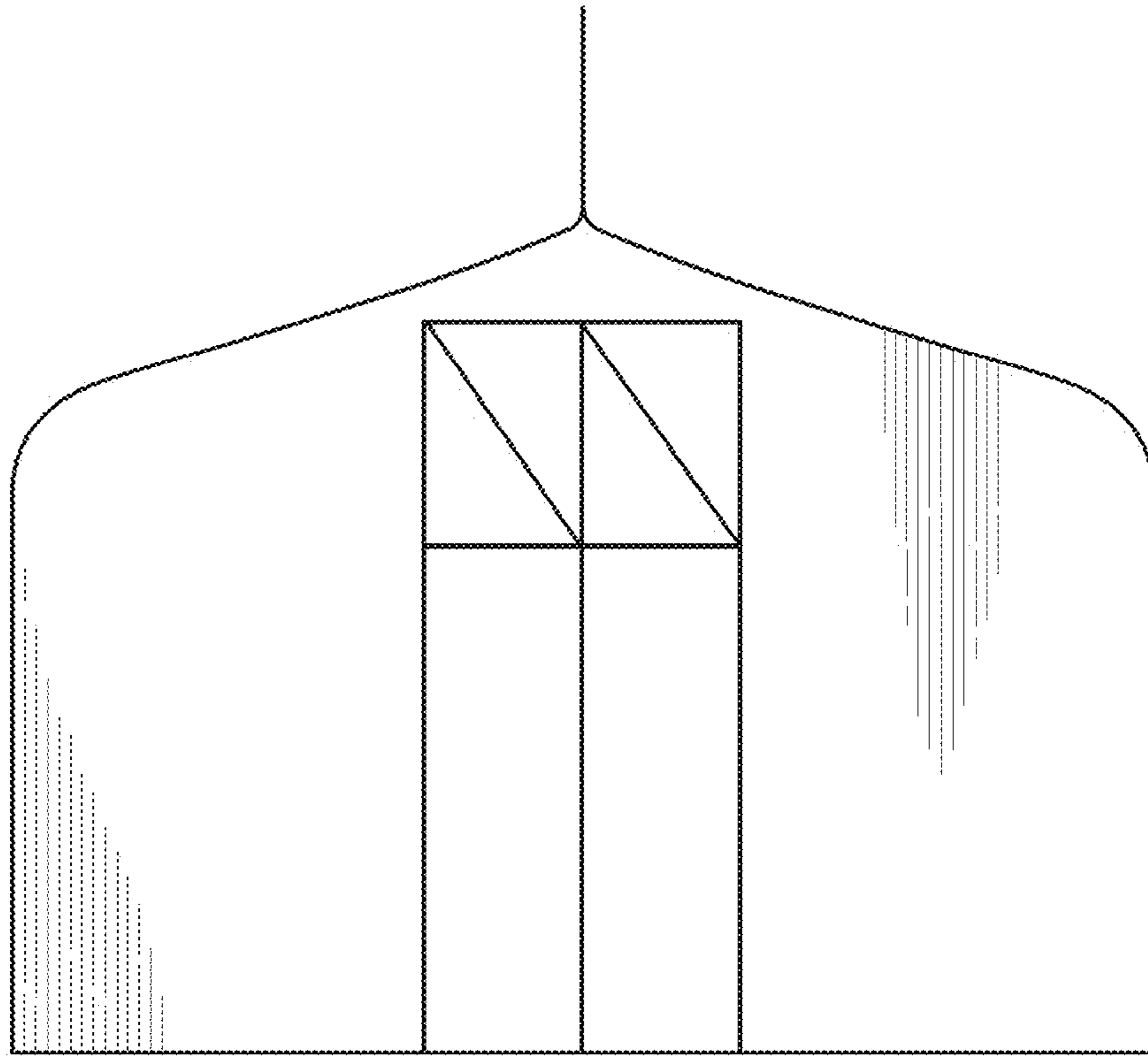

FIG. 7