



US00D739264S

(12) **United States Design Patent**
Buccellato et al.

(10) **Patent No.:** **US D739,264 S**

(45) **Date of Patent:** **** Sep. 22, 2015**

(54) **TRAY WITH FINGER POCKETS**

(71) Applicant: **General Mills, Inc.**, Minneapolis, MN
(US)

(72) Inventors: **James T. Buccellato**, Blaine, MN (US);
Brian Scott Allers, Glens Falls, NY
(US)

(**) Term: **14 Years**

(21) Appl. No.: **29/437,599**

(22) Filed: **Nov. 19, 2012**

(51) **LOC (10) Cl.** **09-03**

(52) **U.S. Cl.**
USPC **D9/761**; D7/357; D7/354

(58) **Field of Classification Search**
USPC D9/737, 761, 760, 424, 456; D7/323,
D7/354, 357, 549, 553, 554, 555; 99/456,
99/324, 325, 339, 425, 426
CPC A21B 3/138; A21B 3/132; A21B 5/02;
F25D 2331/807

See application file for complete search history.

(56) **References Cited**

U.S. PATENT DOCUMENTS

D260,956 S *	9/1981	DesMarais	D7/553.3
D289,854 S *	5/1987	Lane et al.	D9/760
D305,618 S *	1/1990	Blaser	D9/425
D307,864 S *	5/1990	Sorensen	D7/553.3
D328,406 S *	8/1992	Hammond et al.	D7/504
D340,384 S *	10/1993	Couillard et al.	D7/504
D346,528 S *	5/1994	Crawford et al.	D7/357
D428,762 S *	8/2000	Varakian	D7/357
D438,100 S *	2/2001	Cekota	D9/755
D481,584 S *	11/2003	Nolan	D7/357
D488,952 S *	4/2004	Cubillos	D7/357
7,014,162 B2 *	3/2006	Lion et al.	249/121
D556,055 S *	11/2007	Brown	D9/737
D574,180 S *	8/2008	Broom	D7/357
D580,789 S *	11/2008	Larson	D9/761
D616,267 S *	5/2010	Kulzer	D7/701
D616,268 S *	5/2010	Kulzer	D7/701
D616,269 S *	5/2010	Kulzer	D7/701
D616,714 S *	6/2010	Kulzer	D7/701
D616,715 S *	6/2010	Kulzer	D7/701
7,775,392 B2 *	8/2010	Millsap et al.	220/573.1

D628,450 S *	12/2010	Kulzer	D7/701
D643,266 S *	8/2011	Kulzer	D7/701
D653,536 S *	2/2012	Gartz	D9/432
D682,682 S *	5/2013	Biery	D9/432
D710,202 S *	8/2014	Bates et al.	D9/456

* cited by examiner

Primary Examiner — Mark Goodwin

(74) *Attorney, Agent, or Firm* — Diederiks & Whitelaw,
PLC; John L. Crimmins

(57) **CLAIM**

The ornamental design for a tray with finger pockets, shown and described.

DESCRIPTION

FIG. 1 is a top perspective view of a first embodiment for a tray with finger pockets showing our new design;
 FIG. 2 is a bottom perspective view of the tray of FIG. 1;
 FIG. 3 is a top view of the tray of FIG. 1;
 FIG. 4 is a bottom view of the tray of FIG. 1;
 FIG. 5 is an elevation view of one of the opposing short sides of the tray of FIG. 1;
 FIG. 6 is an elevation view of one of the opposing long sides of the tray of FIG. 1;
 FIG. 7 is a cross-sectional elevation view along line 7-7 shown in FIG. 3;
 FIG. 8 is a cross-sectional elevation view along line 8-8 shown in FIG. 3;
 FIG. 9 is a top perspective view of a second embodiment for a tray with finger pockets showing our new design;
 FIG. 10 is a bottom perspective view of the tray of FIG. 9;
 FIG. 11 is a top view of the tray of FIG. 9;
 FIG. 12 is a bottom view of the tray of FIG. 9;
 FIG. 13 is an elevation view of one of the opposing short sides of the tray of FIG. 9;
 FIG. 14 is an elevation view of one of the opposing long sides of the tray of FIG. 9;
 FIG. 15 is a cross-sectional elevation view along line 15-15 shown in FIG. 11;
 FIG. 16 is a cross-sectional elevation view along line 16-16 shown in FIG. 11;

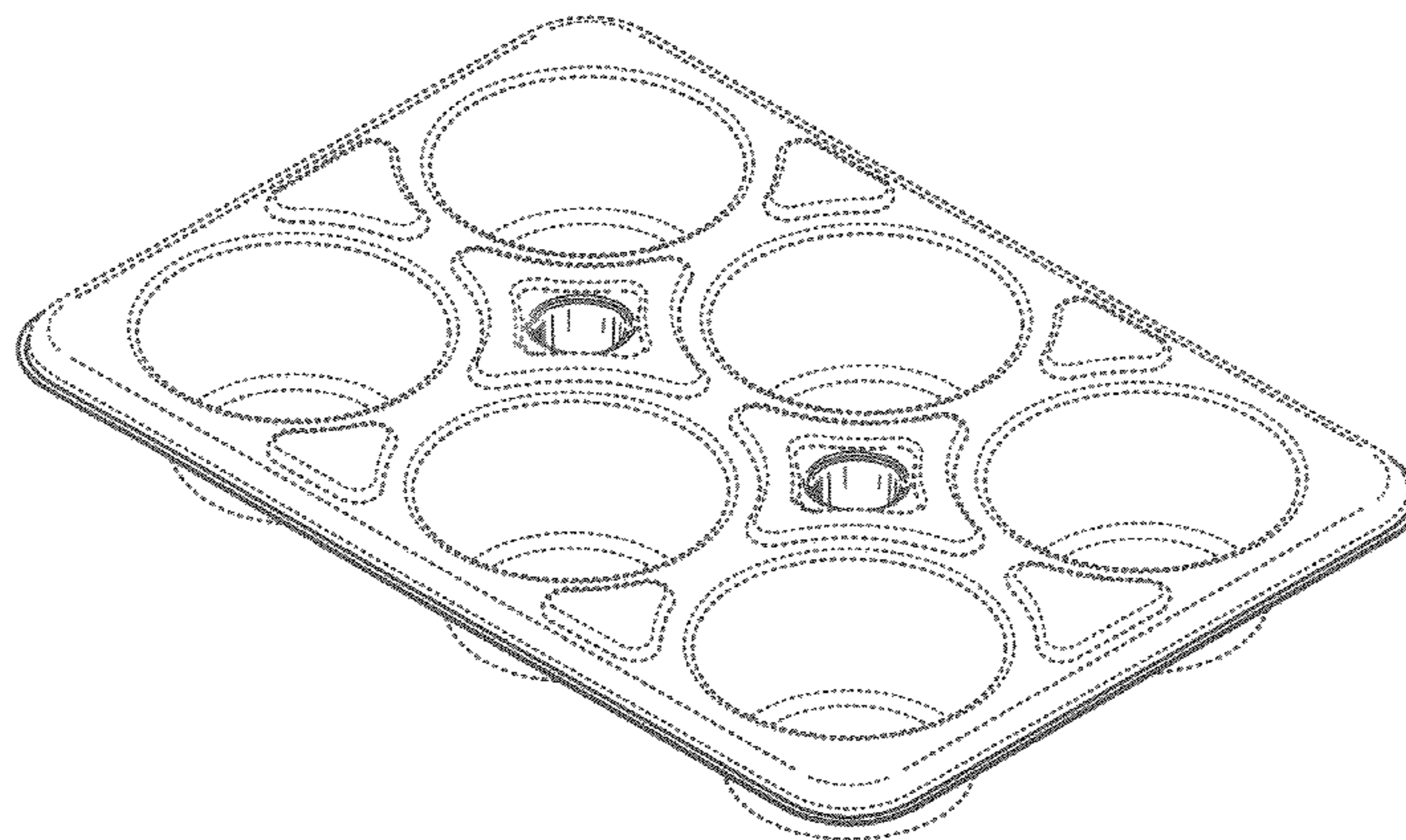

FIG. 17 is a top perspective view of a third embodiment for a tray with finger pockets showing our new design;
FIG. 18 is a bottom perspective view of the tray of FIG. 17;
FIG. 19 is a top view of the tray of FIG. 17;
FIG. 20 is a bottom view of the tray of FIG. 17;
FIG. 21 is an elevation view of one of the opposing short sides of the tray of FIG. 17;
FIG. 22 is an elevation view of one of the opposing long sides of the tray of FIG. 17;
FIG. 23 is a cross-sectional elevation view along line 23-23 shown in FIG. 19;
FIG. 24 is a cross-sectional elevation view along line 24-24 shown in FIG. 19;
FIG. 25 is a top perspective view of a fourth embodiment for a tray with finger pockets showing our new design;
FIG. 26 is a bottom perspective view of the tray of FIG. 25;
FIG. 27 is a top view of the tray of FIG. 25;
FIG. 28 is a bottom view of the tray of FIG. 25;
FIG. 29 is an elevation view of one of the opposing short sides of the tray of FIG. 25;
FIG. 30 is an elevation view of one of the opposing long sides of the tray of FIG. 25;
FIG. 31 is a cross-sectional elevation view along line 31-31 shown in FIG. 27;
FIG. 32 is a cross-sectional elevation view along line 32-32 shown in FIG. 27;
FIG. 33 is a top perspective view of a fifth embodiment for a tray with finger pockets showing our new design;
FIG. 34 is a bottom perspective view of the tray of FIG. 33;
FIG. 35 is a top view of the tray of FIG. 33;
FIG. 36 is a bottom view of the tray of FIG. 33;
FIG. 37 is an elevation view of one of the opposing short sides of the tray of FIG. 33;
FIG. 38 is an elevation view of one of the opposing long sides of the tray of FIG. 33;
FIG. 39 is a cross-sectional elevation view along line 39-39 shown in FIG. 35;
FIG. 40 is a cross-sectional elevation view along line 40-40 shown in FIG. 35;
FIG. 41 is a top perspective view of a sixth embodiment for a tray with finger pockets showing our new design;
FIG. 42 is a bottom perspective view of the tray of FIG. 41;
FIG. 43 is a top view of the tray of FIG. 41;
FIG. 44 is a bottom view of the tray of FIG. 41;
FIG. 45 is an elevation view of one of the opposing short sides of the tray of FIG. 41;
FIG. 46 is an elevation view of one of the opposing long sides of the tray of FIG. 41;
FIG. 47 is a cross-sectional elevation view along line 47-47 shown in FIG. 43;
FIG. 48 is a cross-sectional elevation view along line 48-48 shown in FIG. 43;
FIG. 49 is a top perspective view of a seventh embodiment for a tray with finger pockets showing our new design;
FIG. 50 is a bottom perspective view of the tray of FIG. 49;
FIG. 51 is a top view of the tray of FIG. 49;
FIG. 52 is a bottom view of the tray of FIG. 49;

FIG. 53 is an elevation view of one of the opposing short sides of the tray of FIG. 49;
FIG. 54 is an elevation view of one of the opposing long sides of the tray of FIG. 49;
FIG. 55 is a cross-sectional elevation view along line 55-55 shown in FIG. 51;
FIG. 56 is a cross-sectional elevation view along line 56-56 shown in FIG. 51;
FIG. 57 is a top perspective view of a eighth embodiment for a tray with finger pockets showing our new design;
FIG. 58 is a bottom perspective view of the tray of FIG. 57;
FIG. 59 is a top view of the tray of FIG. 57;
FIG. 60 is a bottom view of the tray of FIG. 57;
FIG. 61 is an elevation view of one of the opposing short sides of the tray of FIG. 57;
FIG. 62 is an elevation view of one of the opposing long sides of the tray of FIG. 57;
FIG. 63 is a cross-sectional elevation view along line 63-63 shown in FIG. 59;
FIG. 64 is a cross-sectional elevation view along line 64-64 shown in FIG. 59;
FIG. 65 is a top perspective view of a ninth embodiment for a tray with finger pockets showing our new design;
FIG. 66 is a bottom perspective view of the tray of FIG. 65;
FIG. 67 is a top view of the tray of FIG. 65;
FIG. 68 is a bottom view of the tray of FIG. 65;
FIG. 69 is an elevation view of one of the opposing short sides of the tray of FIG. 65;
FIG. 70 is an elevation view of one of the opposing long sides of the tray of FIG. 65;
FIG. 71 is a cross-sectional elevation view along line 71-71 shown in FIG. 67;
FIG. 72 is a cross-sectional elevation view along line 72-72 shown in FIG. 67;
FIG. 73 is a top perspective view of a tenth embodiment for a tray with finger pockets showing our new design;
FIG. 74 is a bottom perspective view of the tray of FIG. 73;
FIG. 75 is a top view of the tray of FIG. 73;
FIG. 76 is a bottom view of the tray of FIG. 73;
FIG. 77 is an elevation view of one of the opposing short sides of the tray of FIG. 73;
FIG. 78 is an elevation view of one of the opposing long sides of the tray of FIG. 73;
FIG. 79 is a cross-sectional elevation view along line 79-79 shown in FIG. 75; and,
FIG. 80 is a cross-sectional elevation view along line 80-80 shown in FIG. 75.
Where included, broken lines showing structural and/or other features in the various embodiments of the tray with finger pockets are for illustrative purposes only and, as such, form no part of the claimed design. Unless illustrated or stated otherwise, the opposing long sides in any one embodiment of the tray with finger pockets are substantially identical to one another, and the opposing short sides in any one embodiment of the tray with finger pockets are substantially identical to one another.

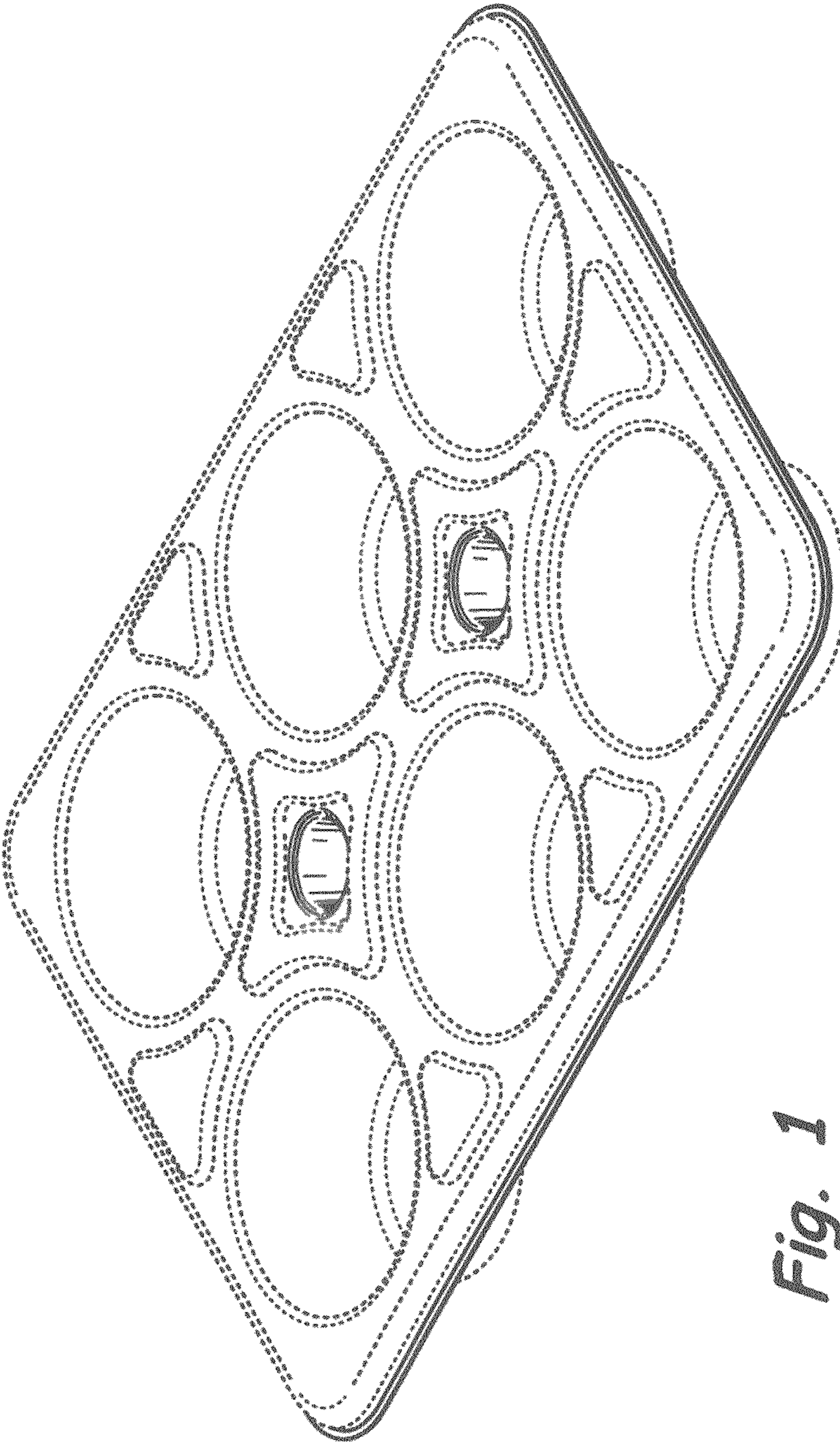

Fig. 1

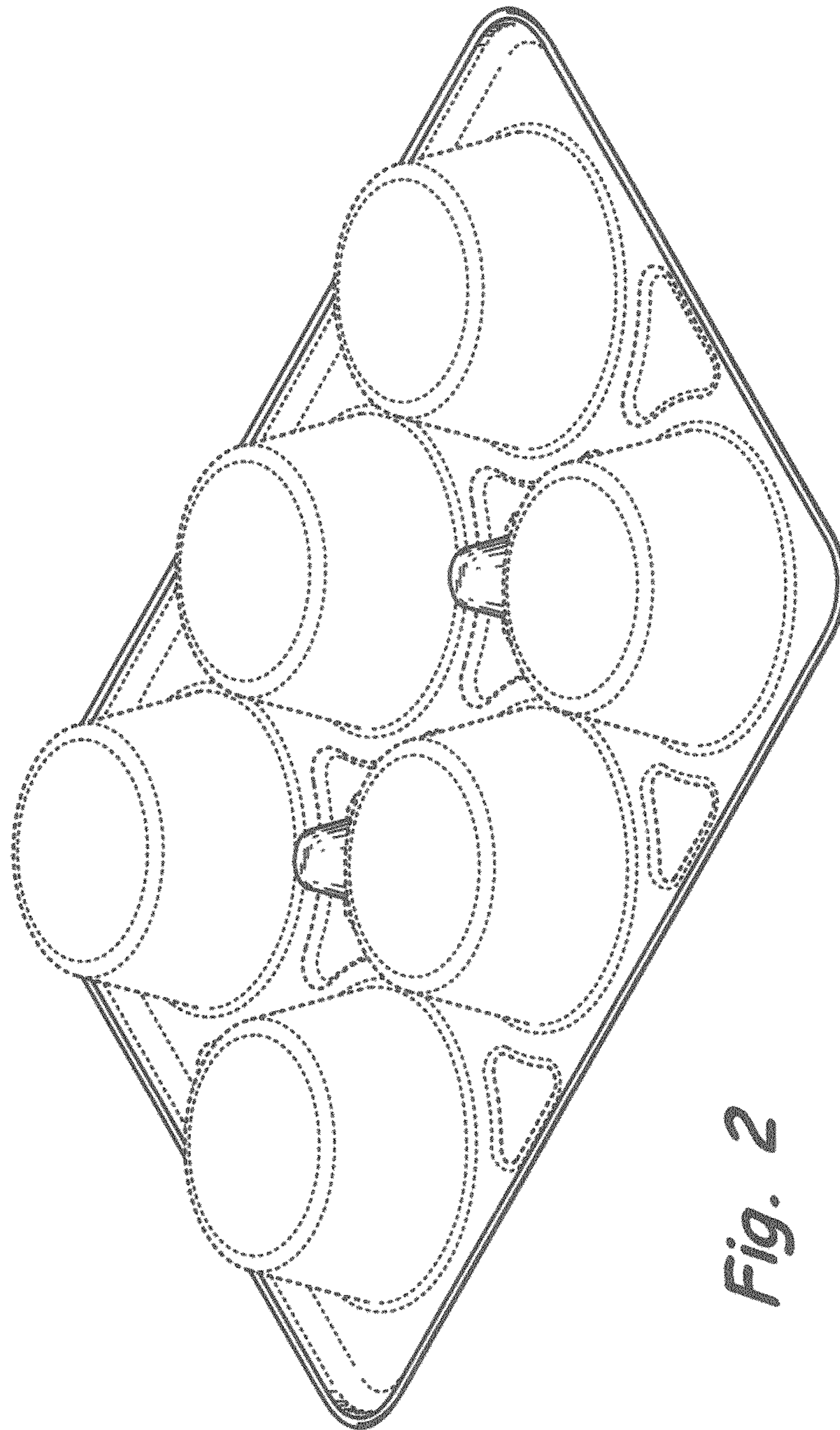

Fig. 2

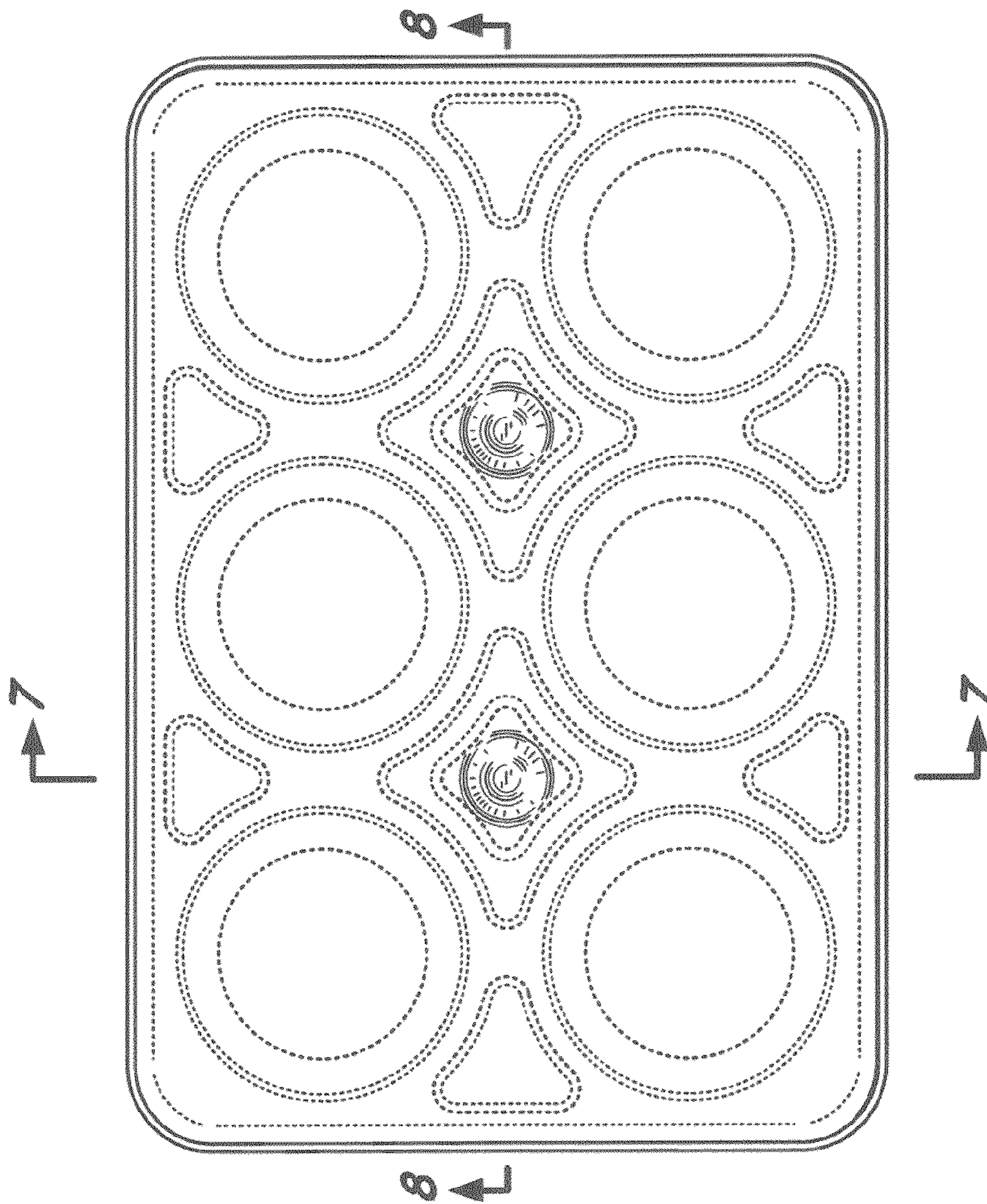

Fig. 3

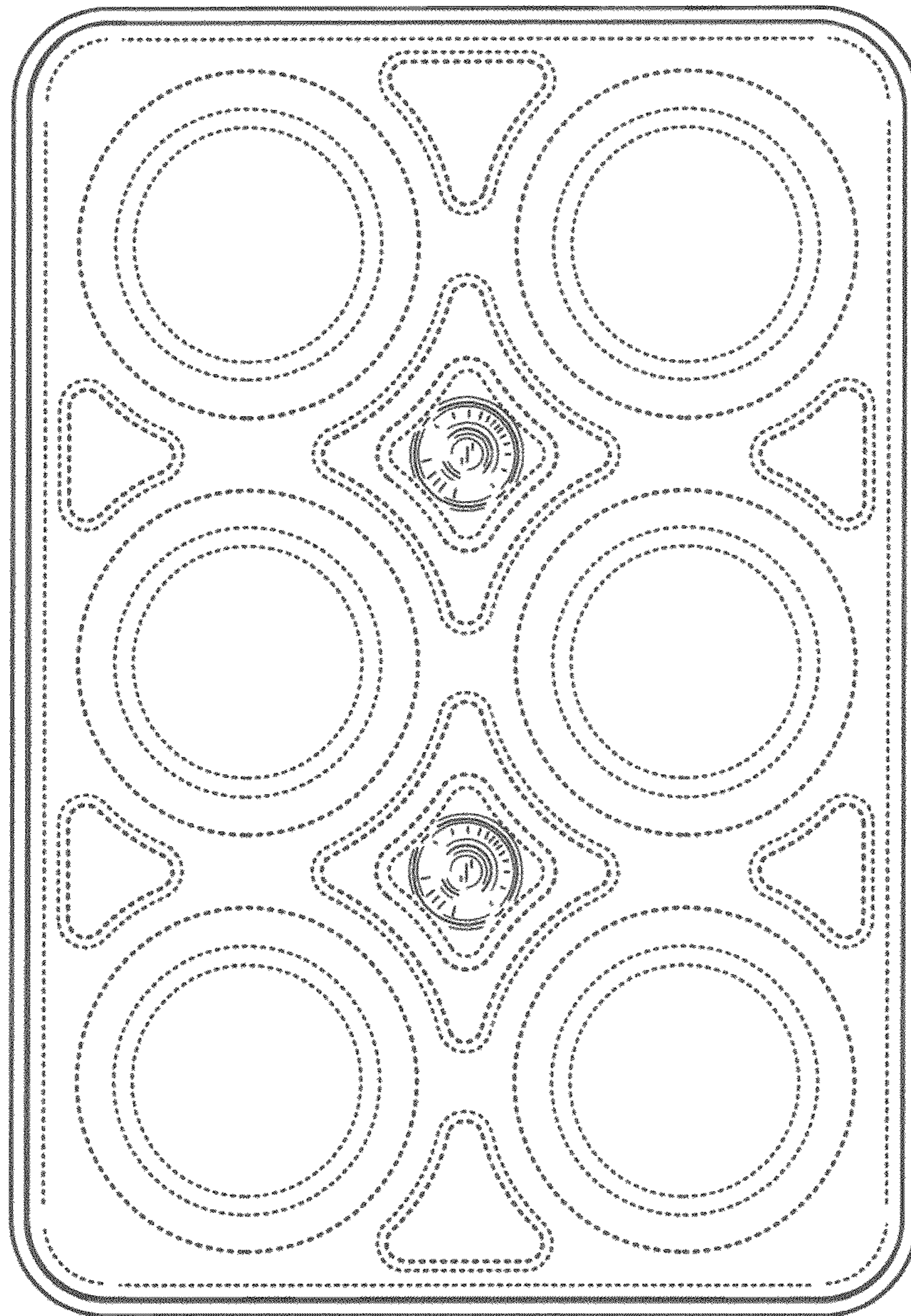

Fig. 4

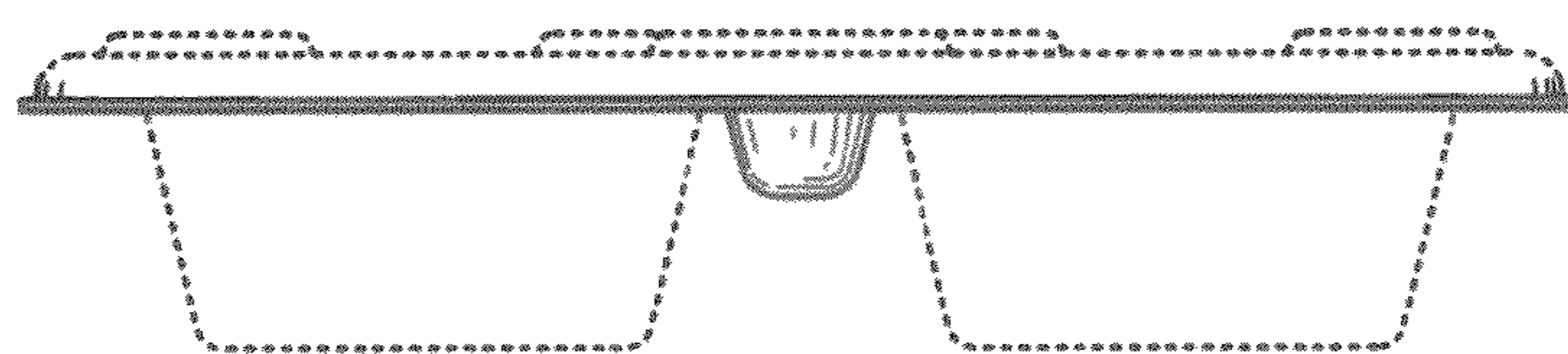

Fig. 5

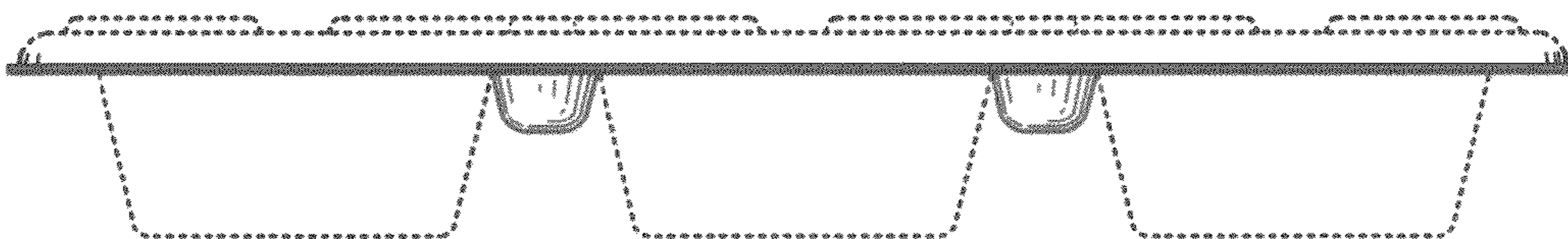

Fig. 6

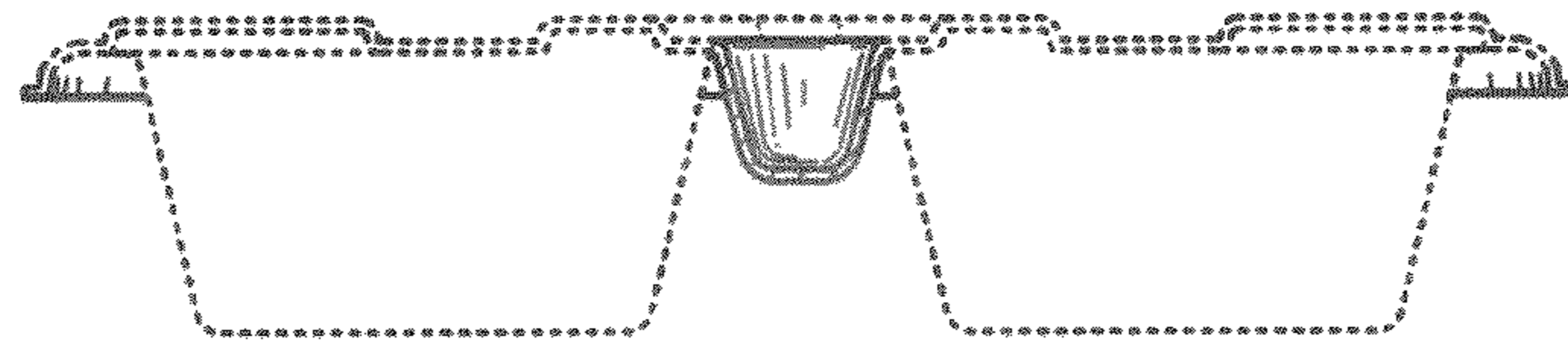

Fig. 7

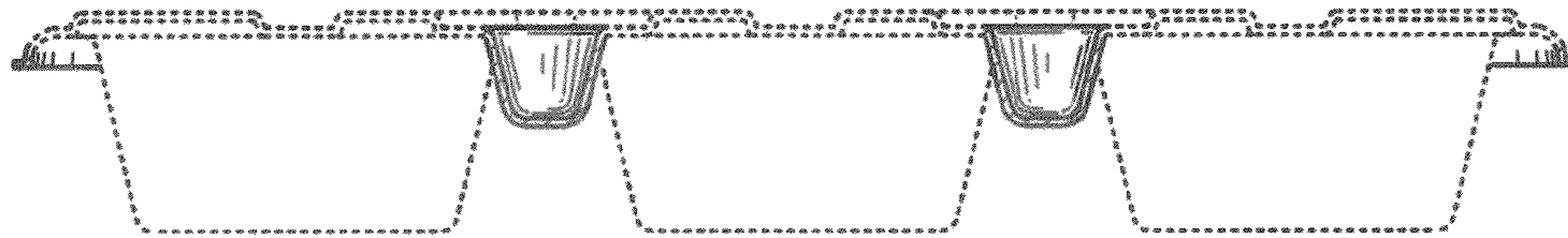

Fig. 8

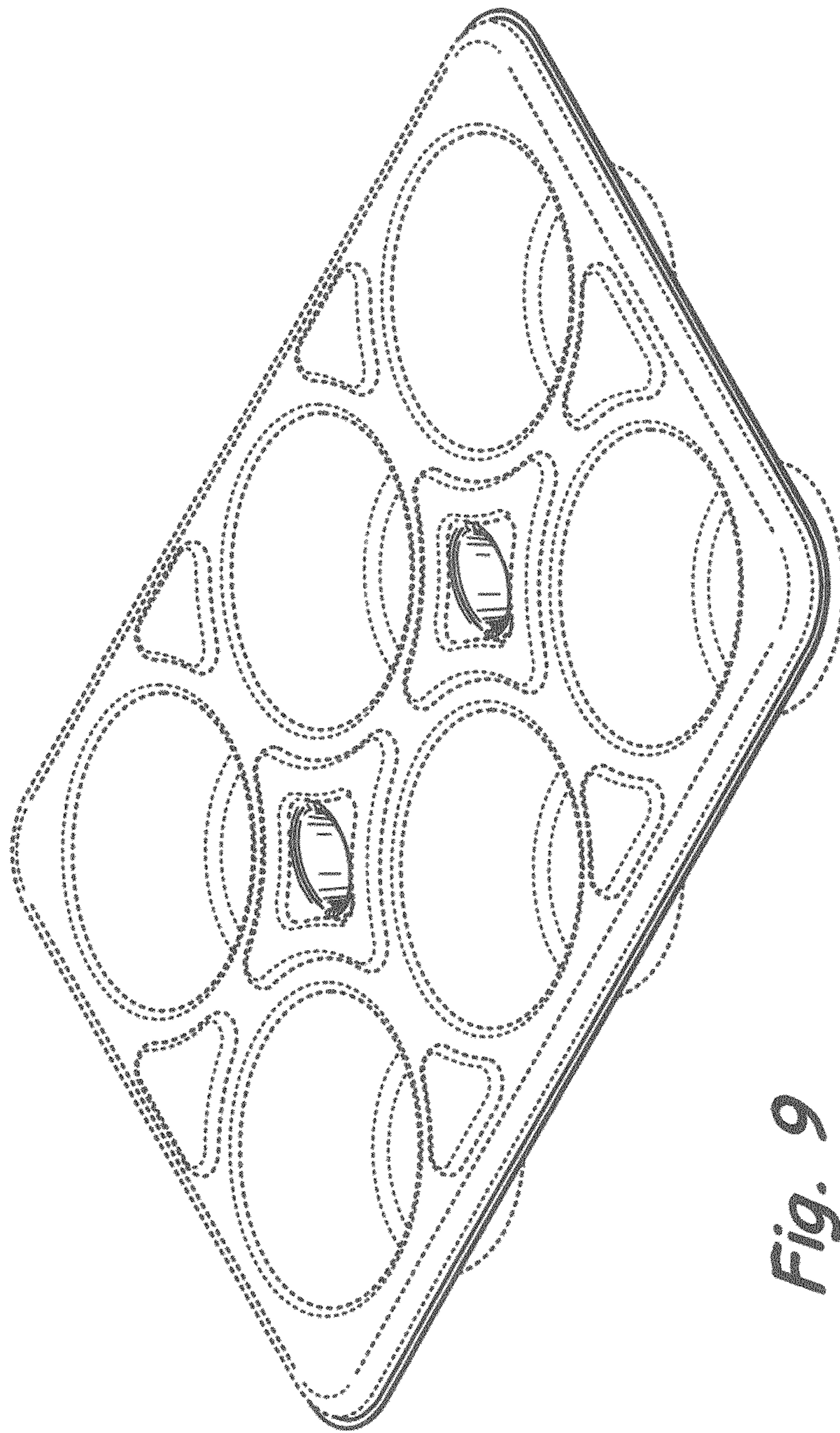

Fig. 9

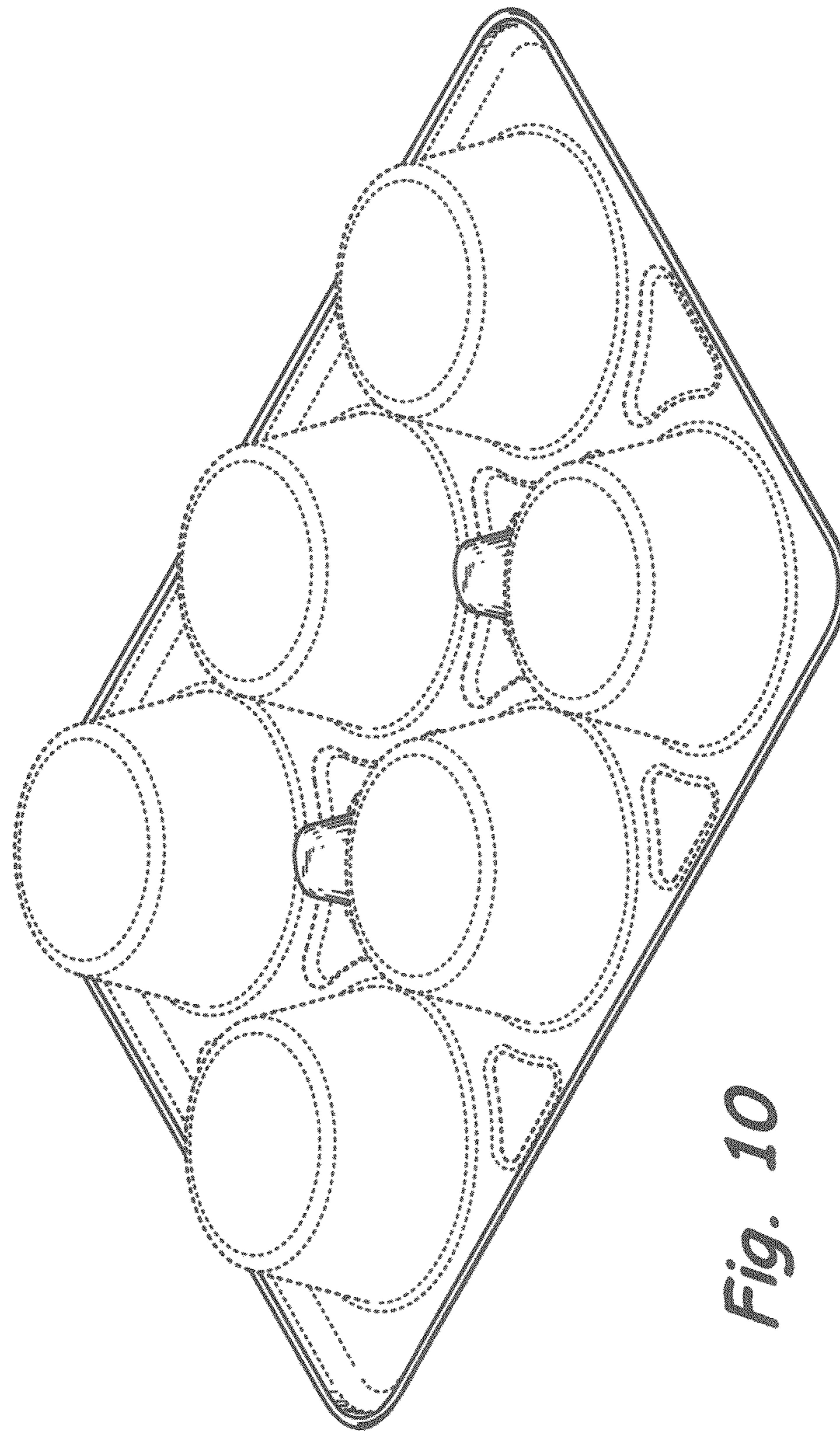

Fig. 10

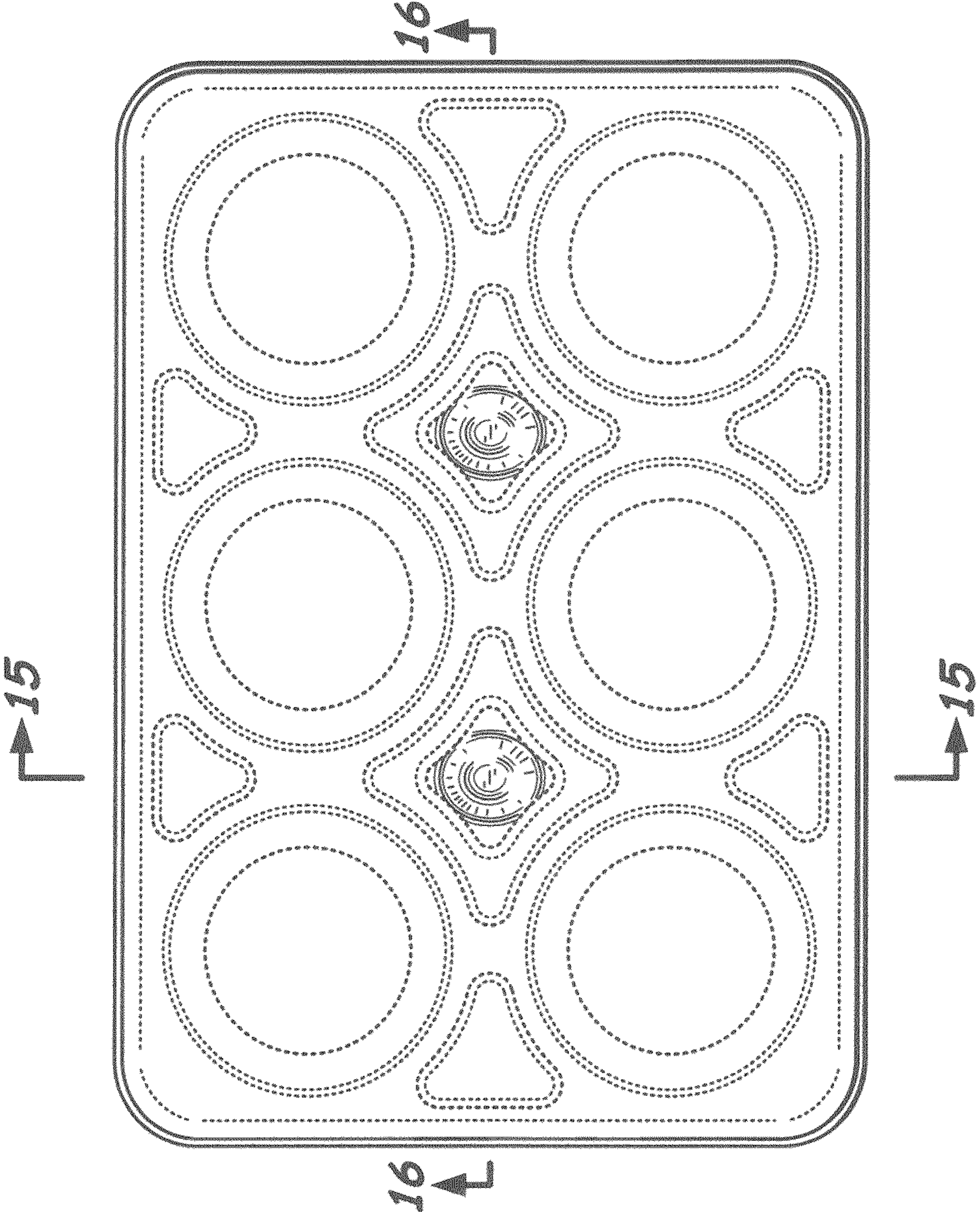

Fig. 11

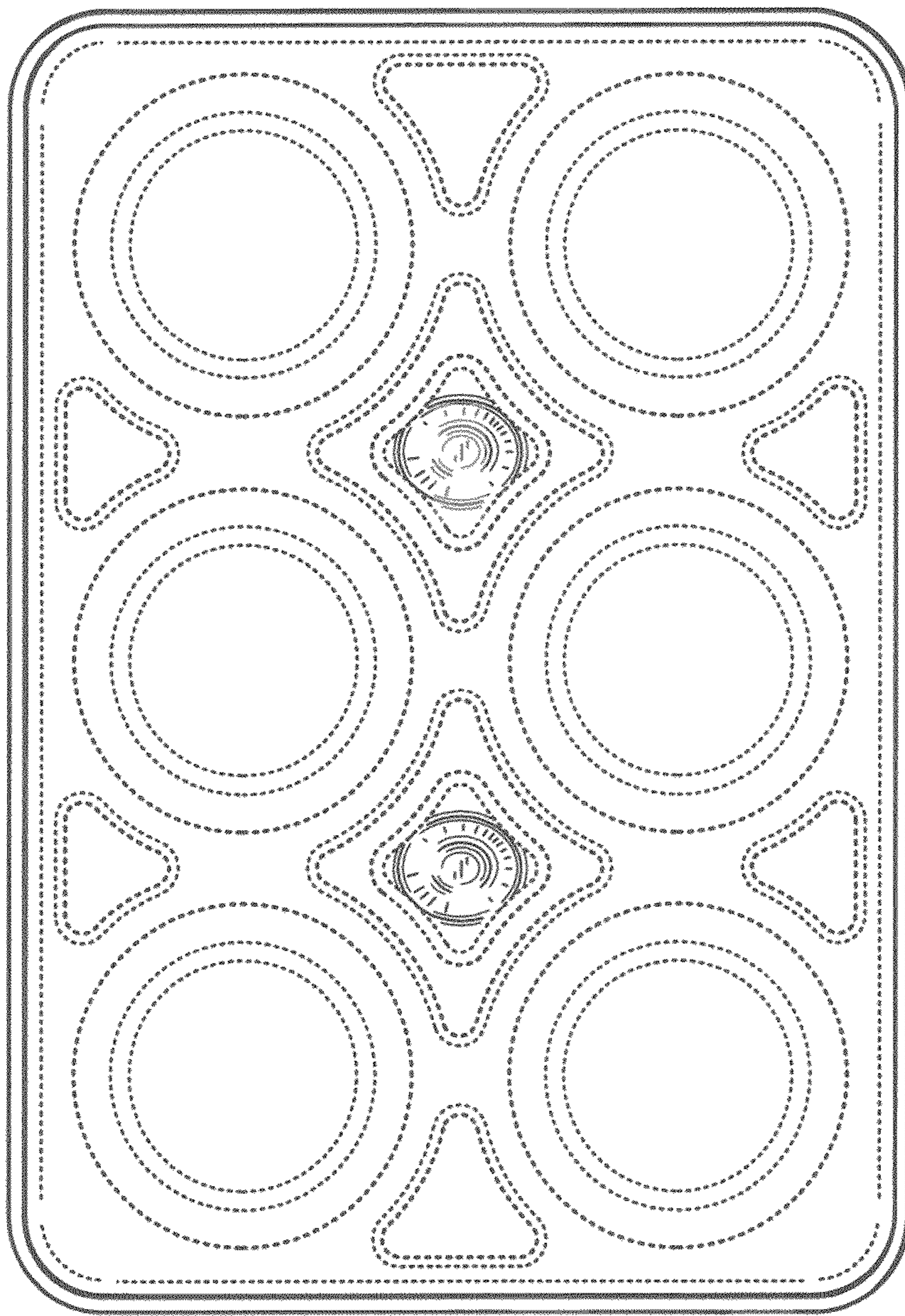

Fig. 12

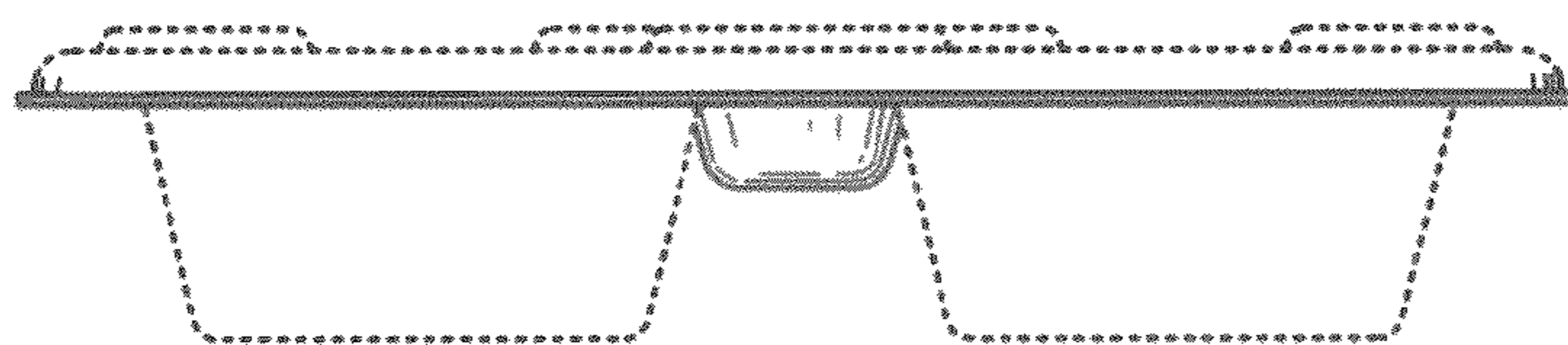

Fig. 13

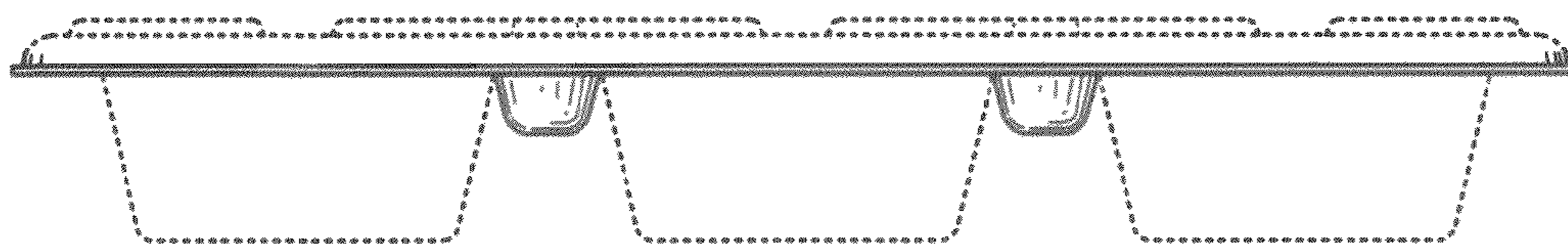

Fig. 14

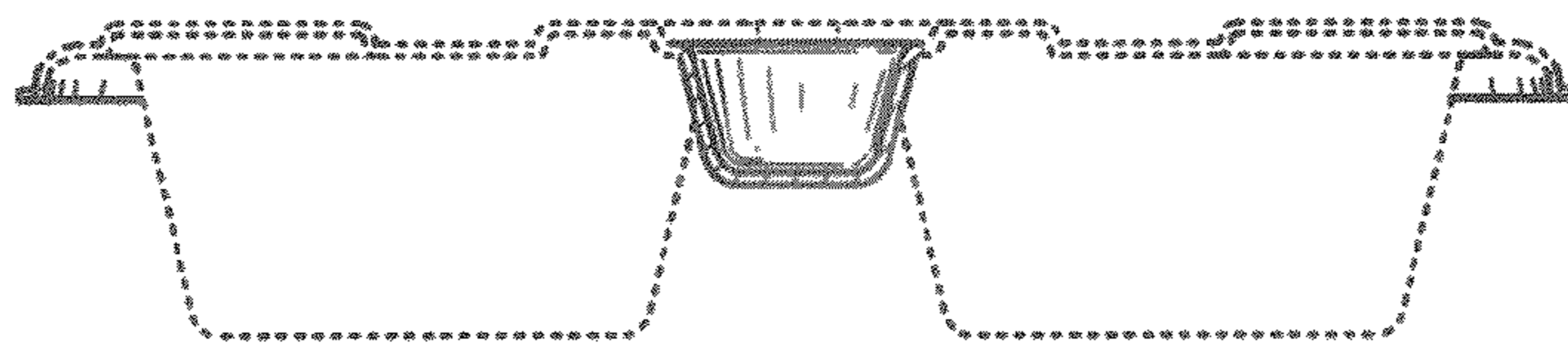

Fig. 15

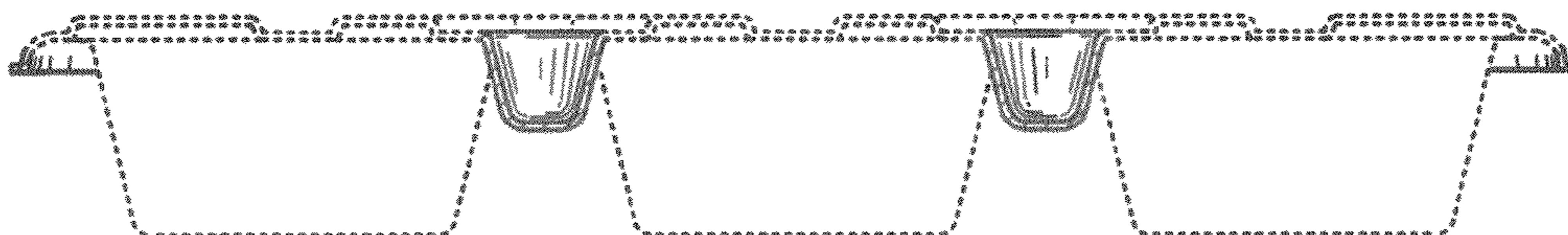

Fig. 16

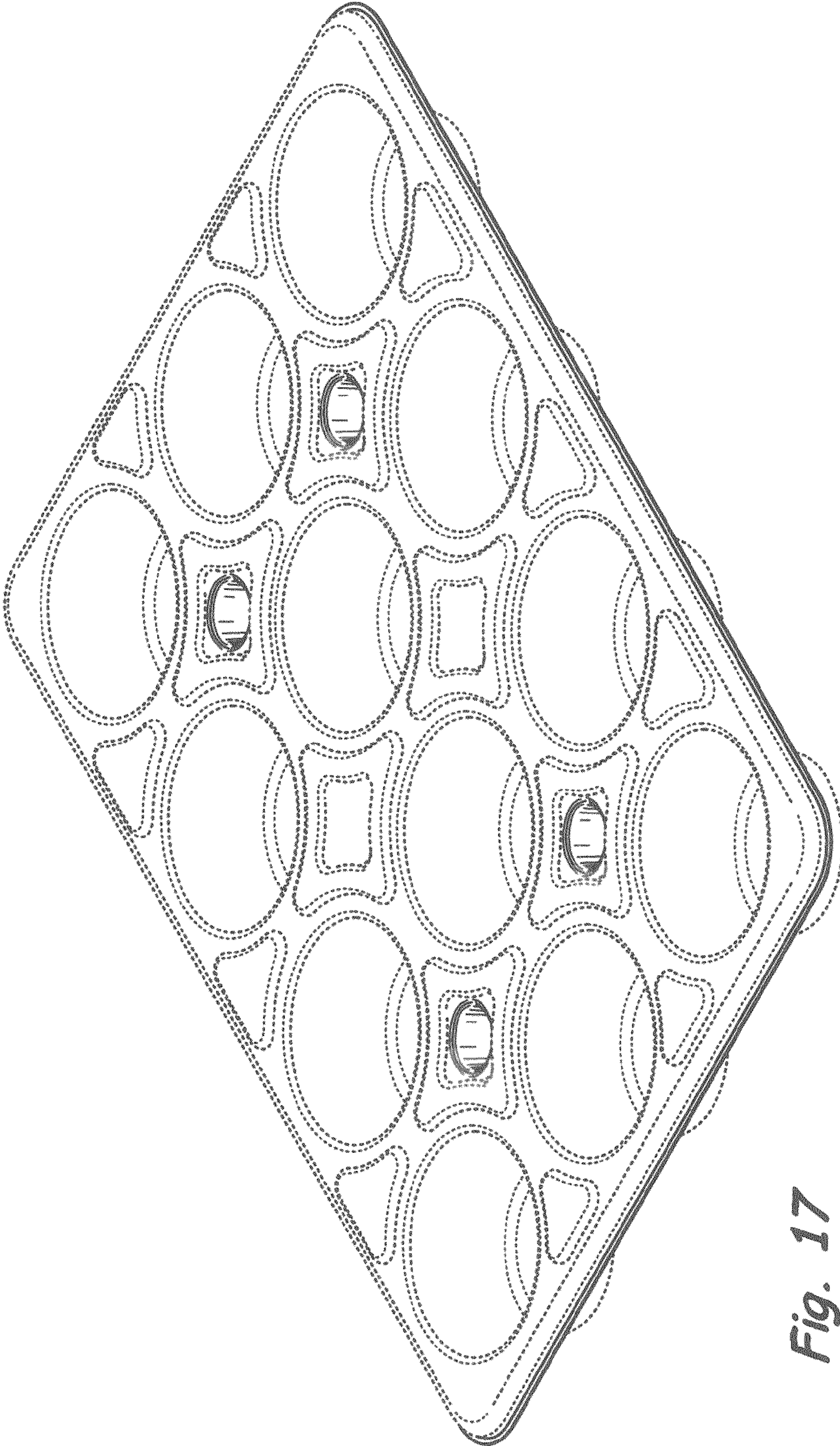

Fig. 17

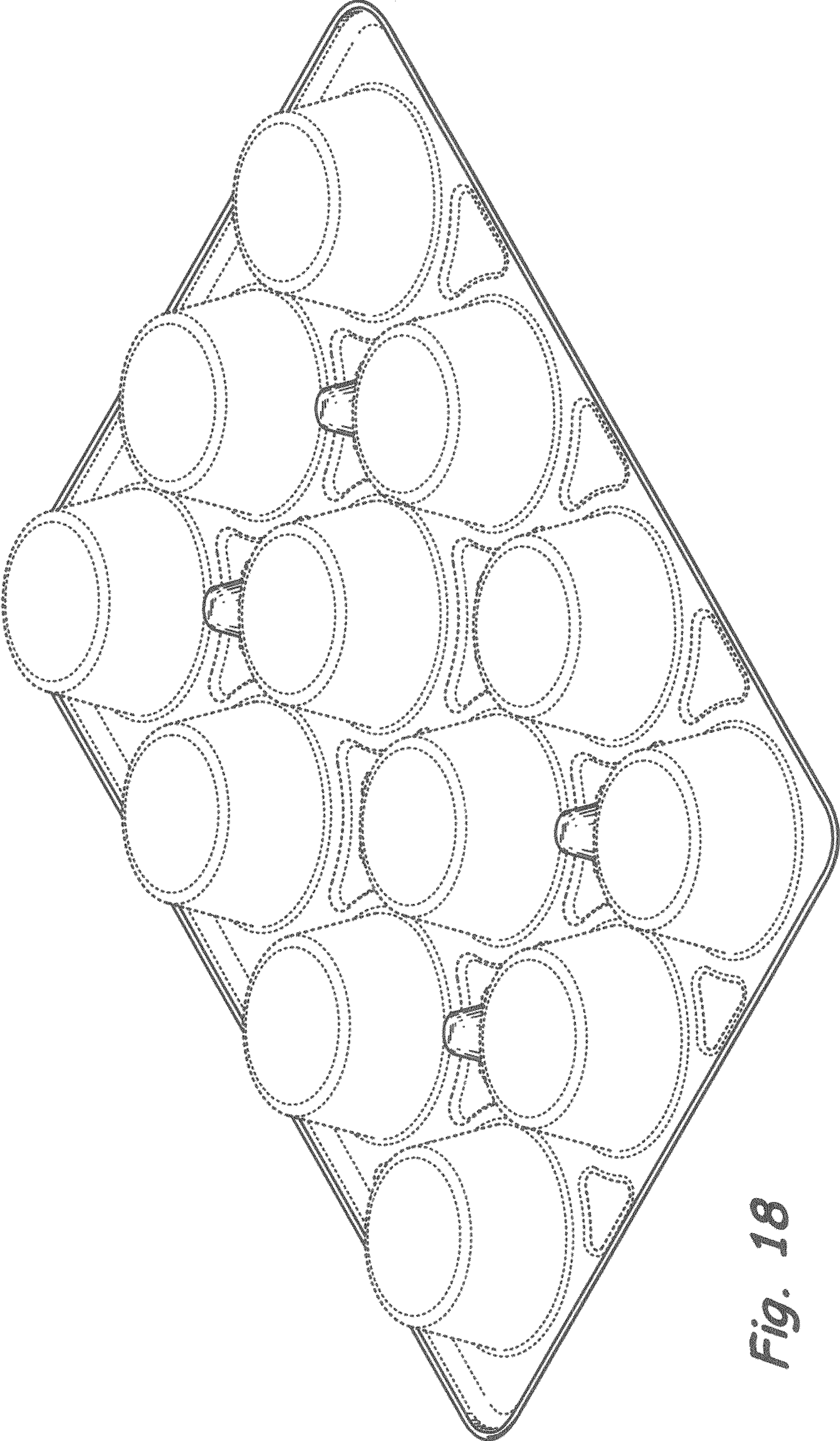

Fig. 18

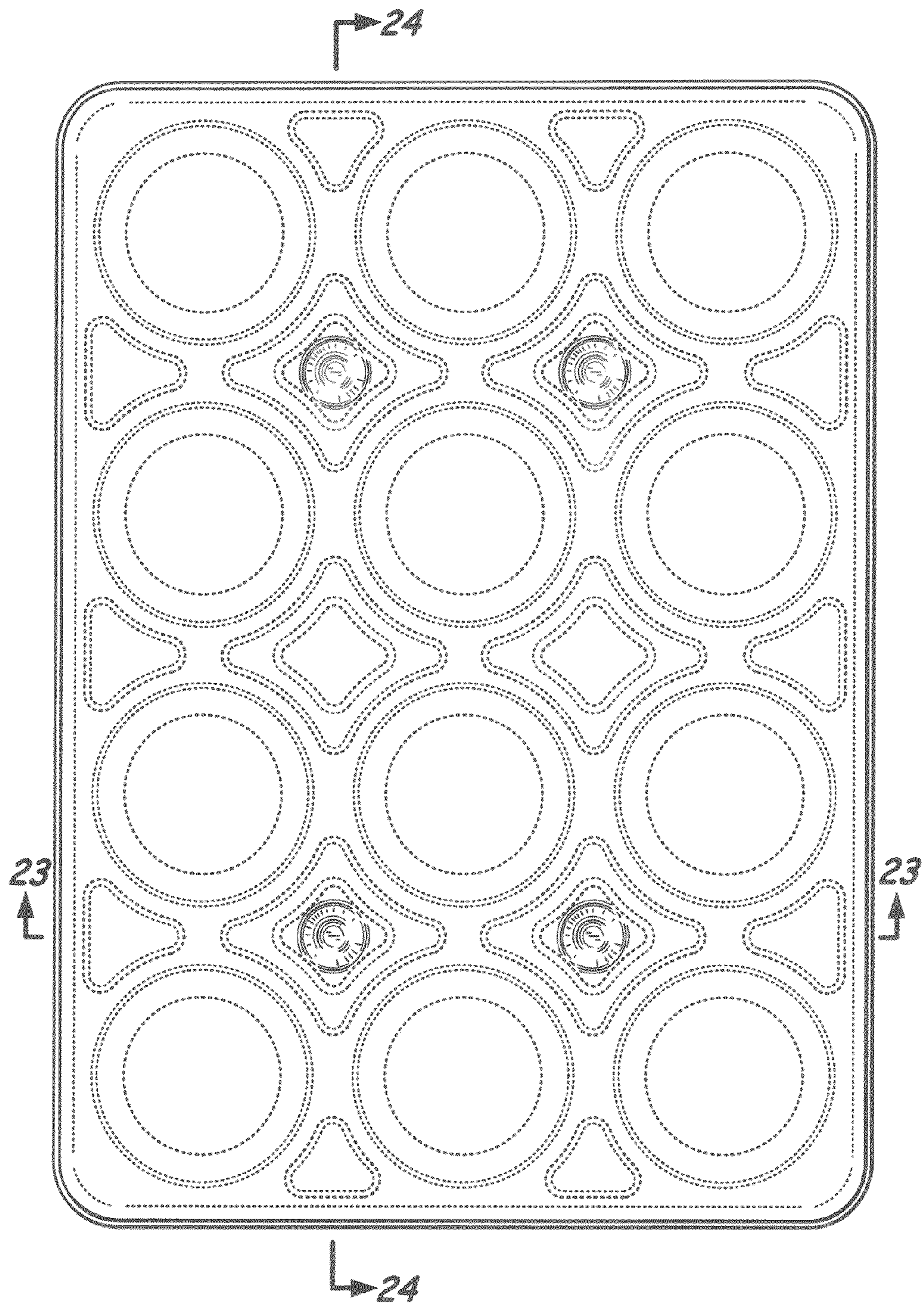

Fig. 19

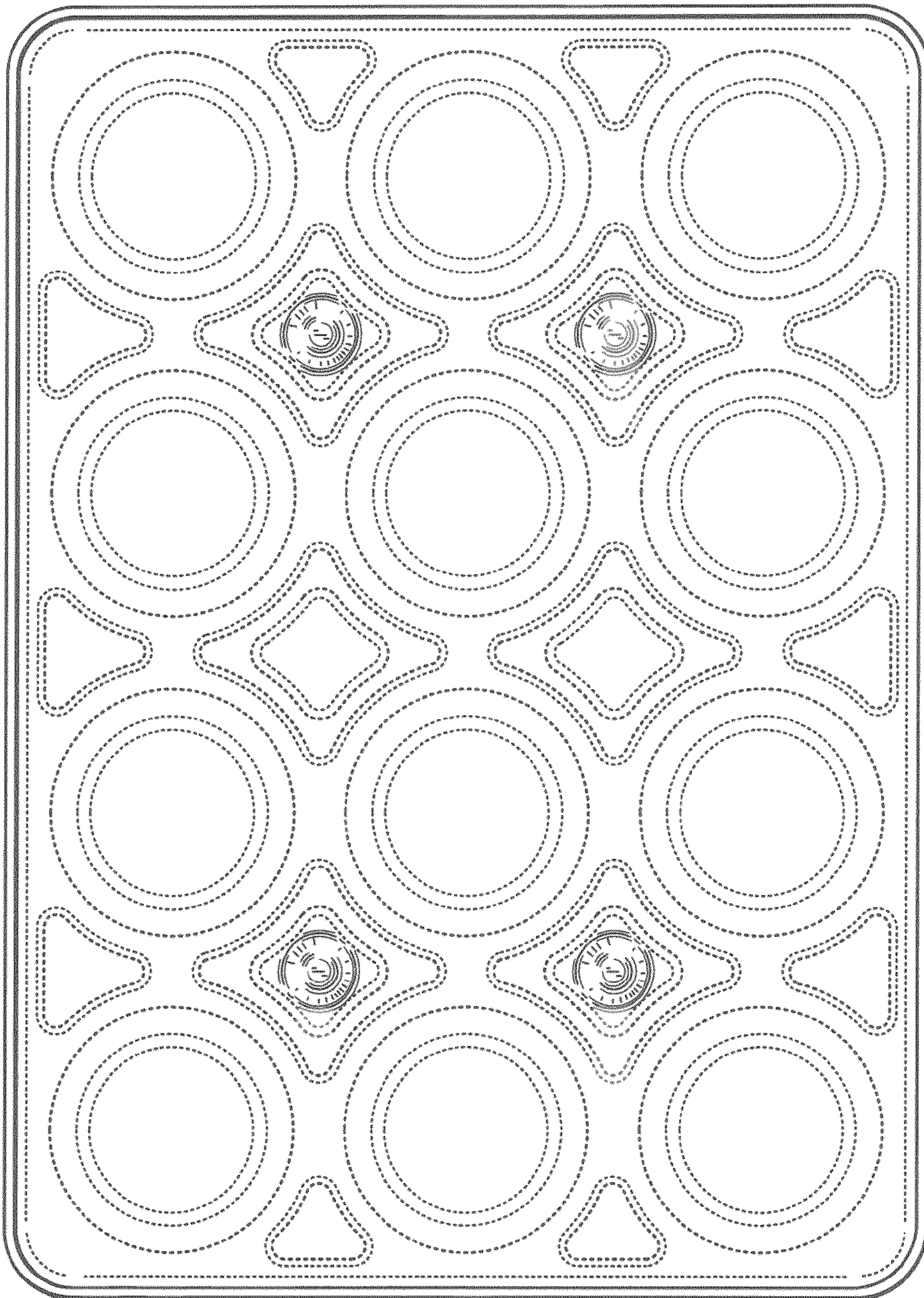

Fig. 20

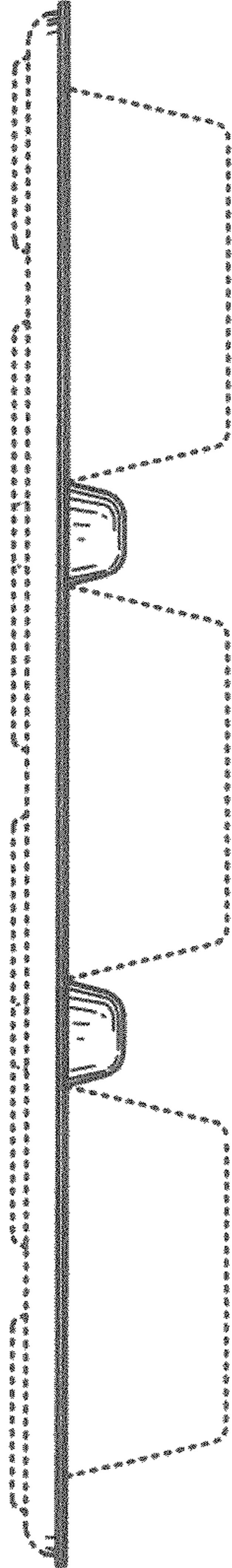

Fig. 21

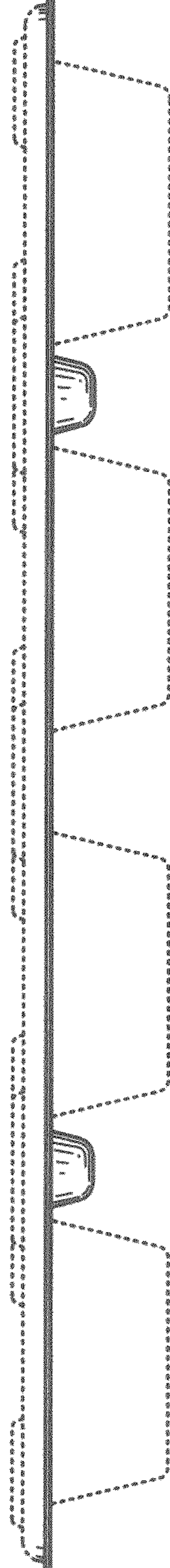

Fig. 22

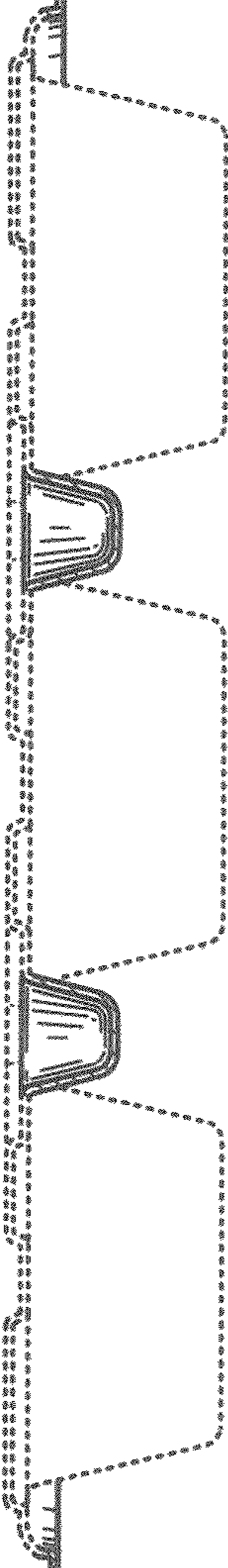

Fig. 23

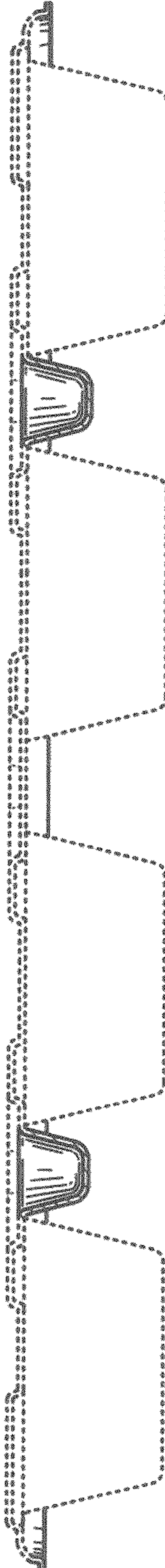

Fig. 24

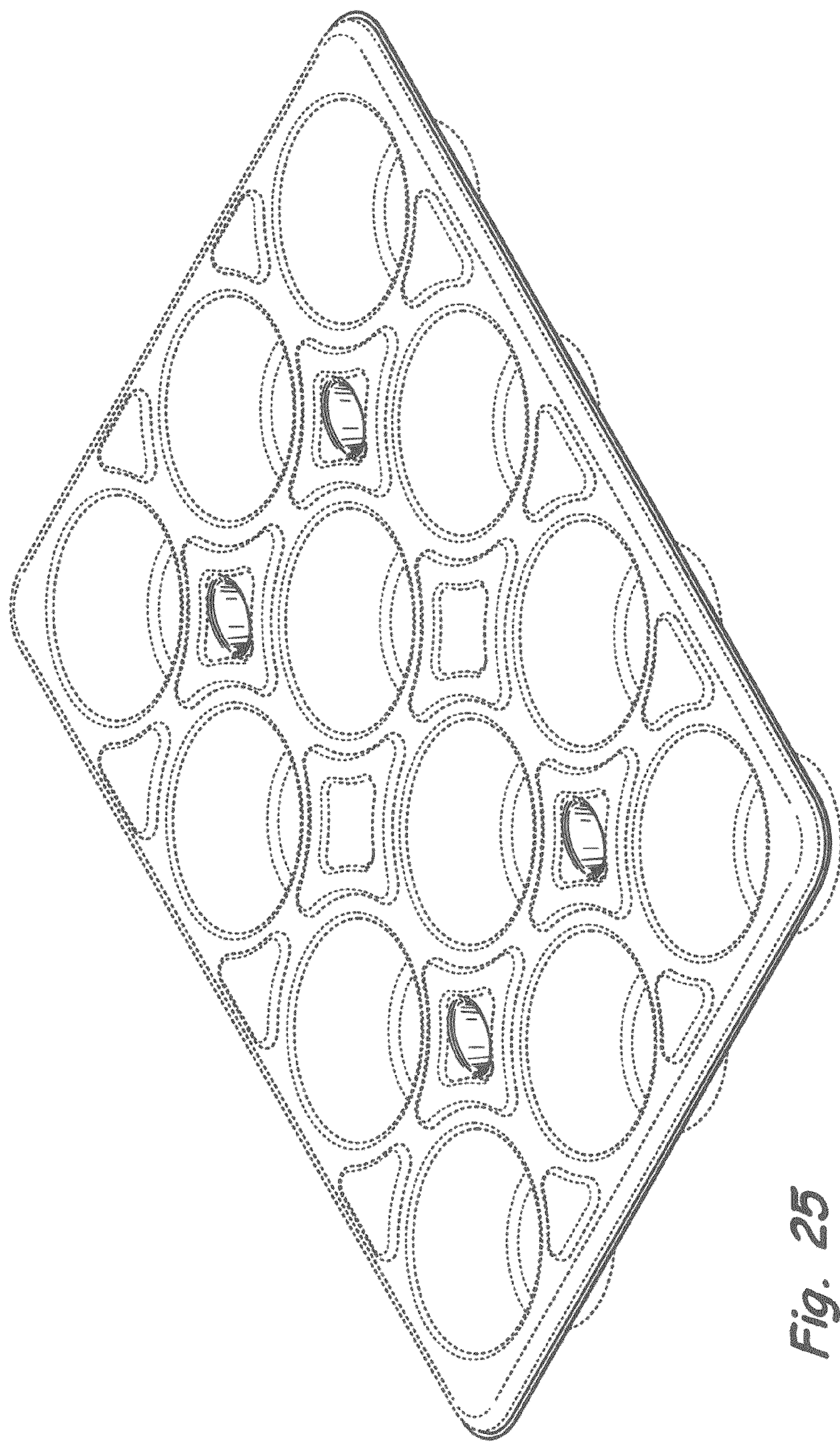

Fig. 25

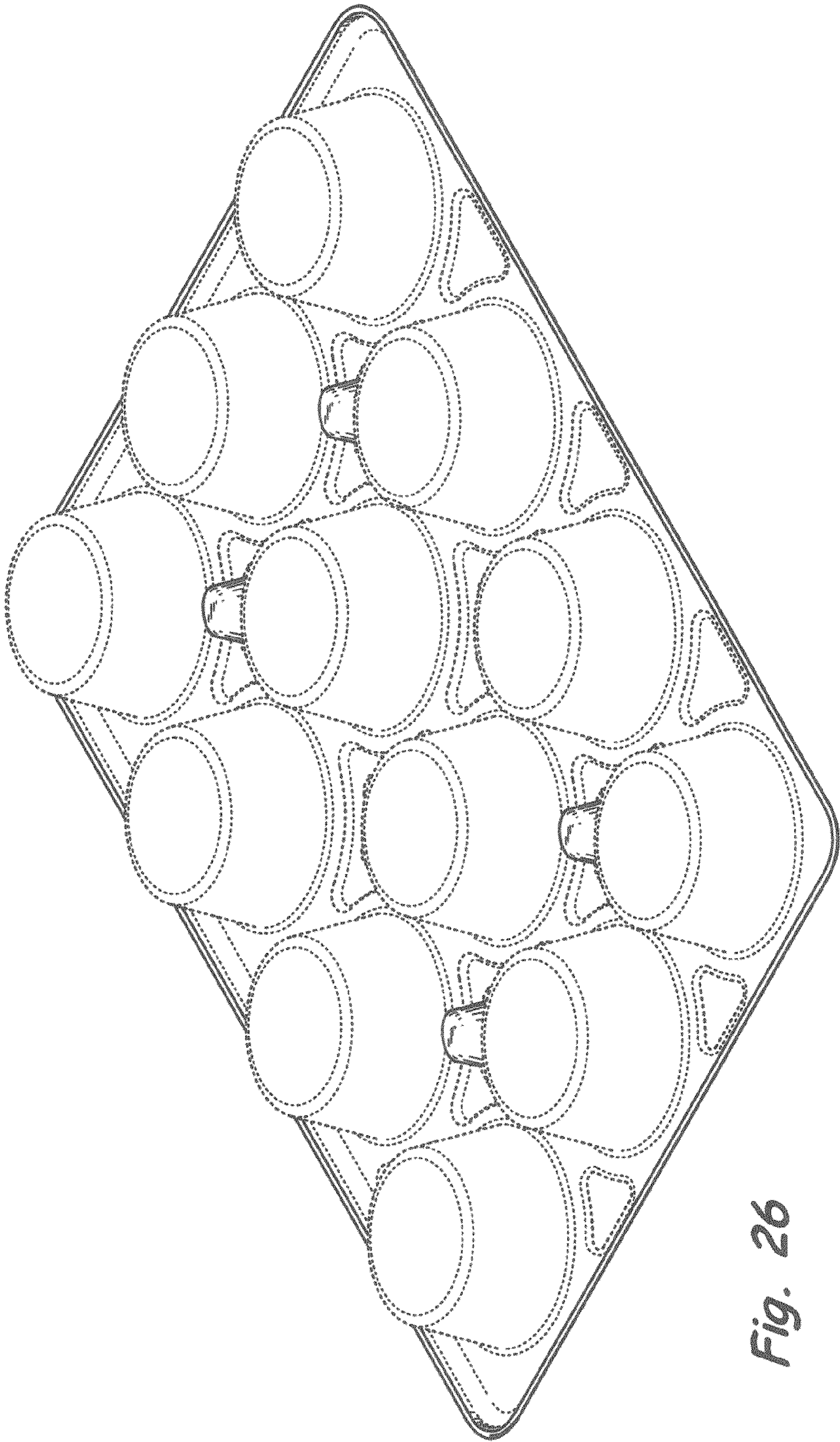

Fig. 26

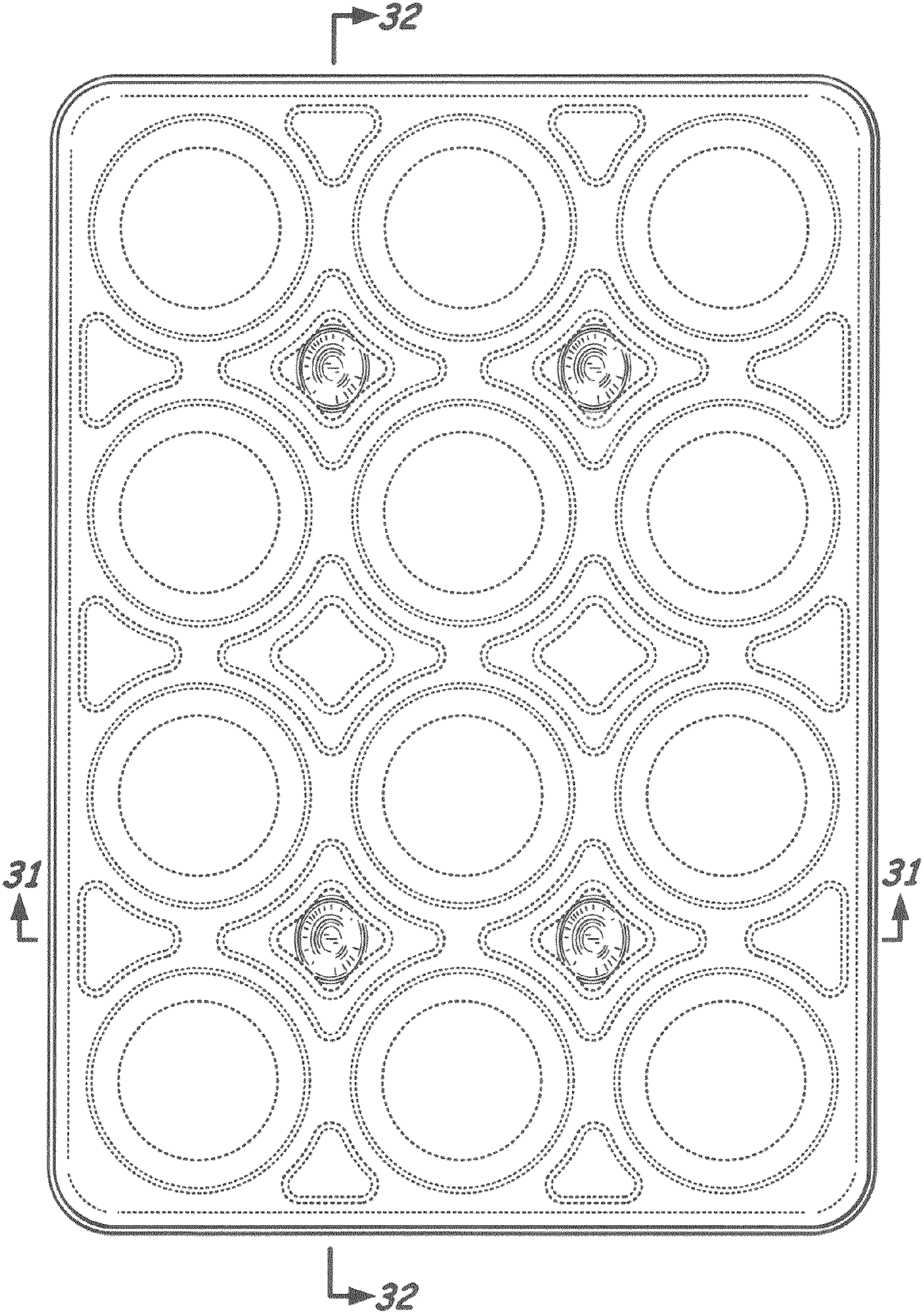

Fig. 27

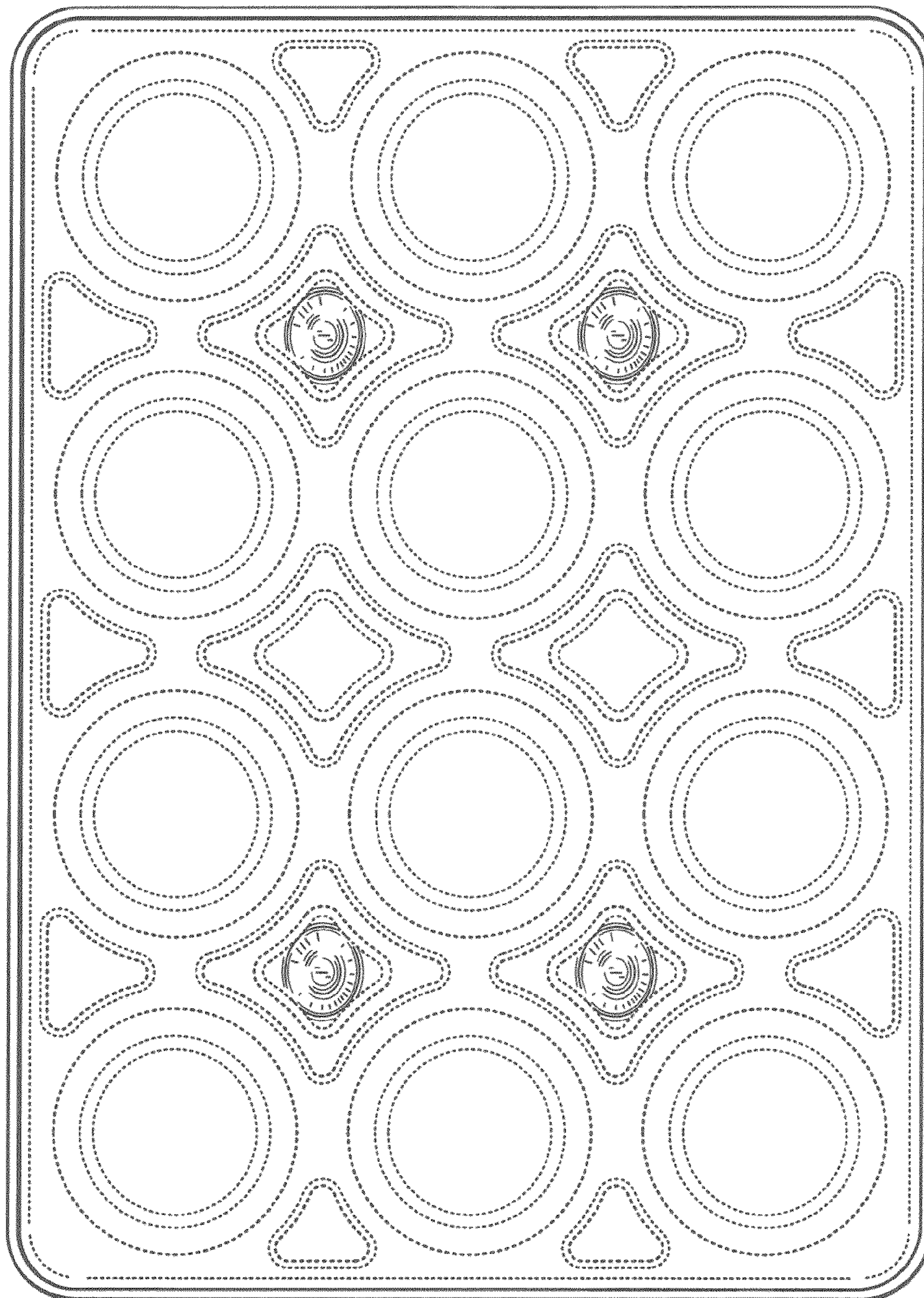

Fig. 28

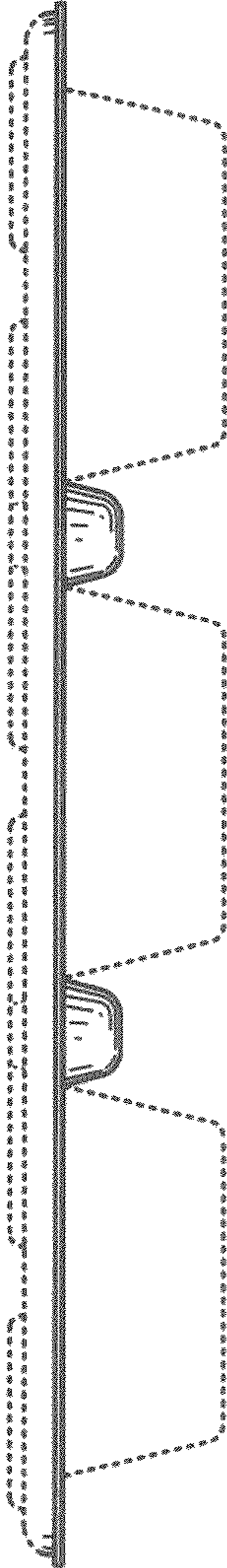

Fig. 29

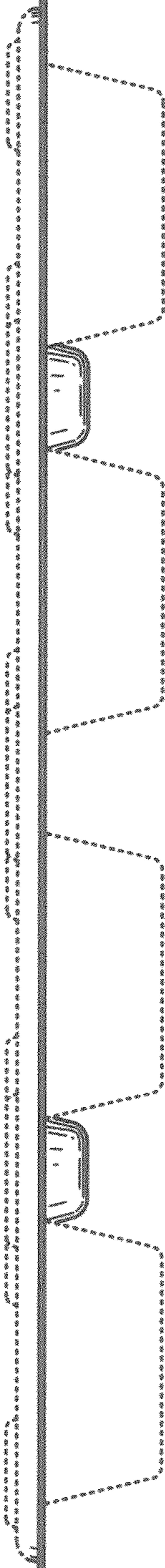

Fig. 30

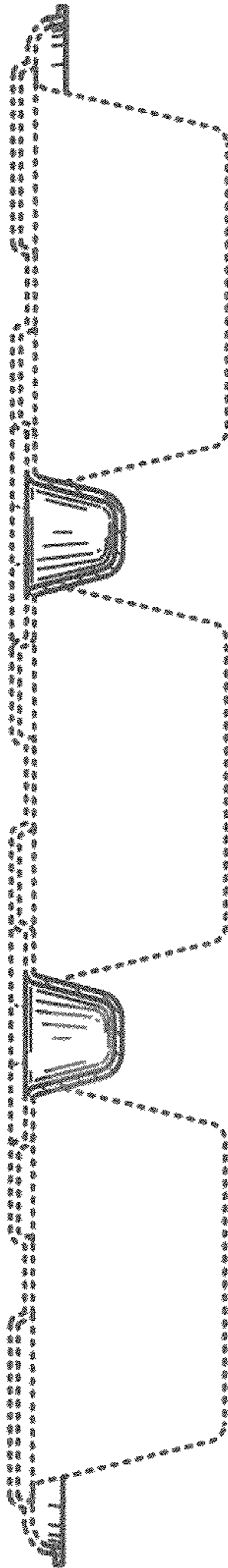

Fig. 31

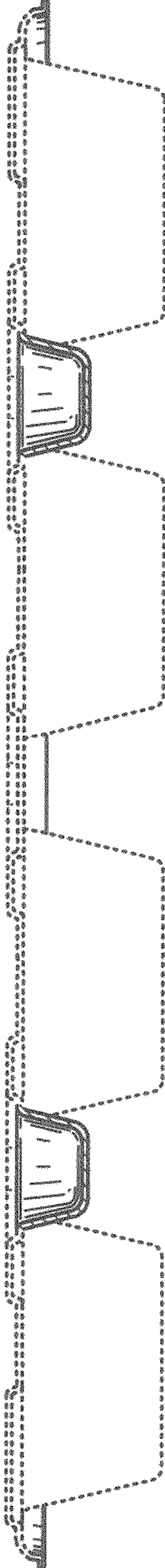

Fig. 32

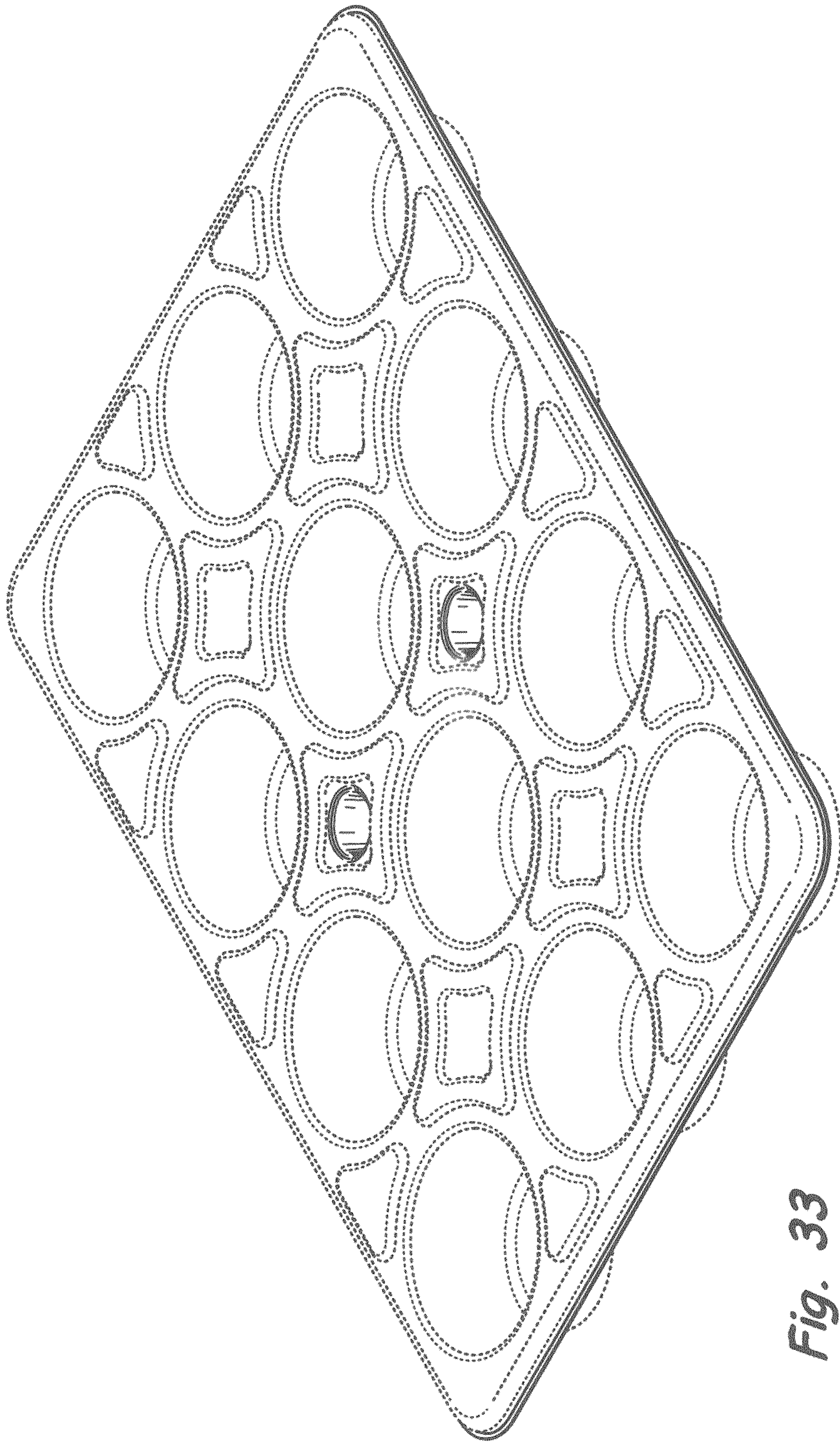

Fig. 33

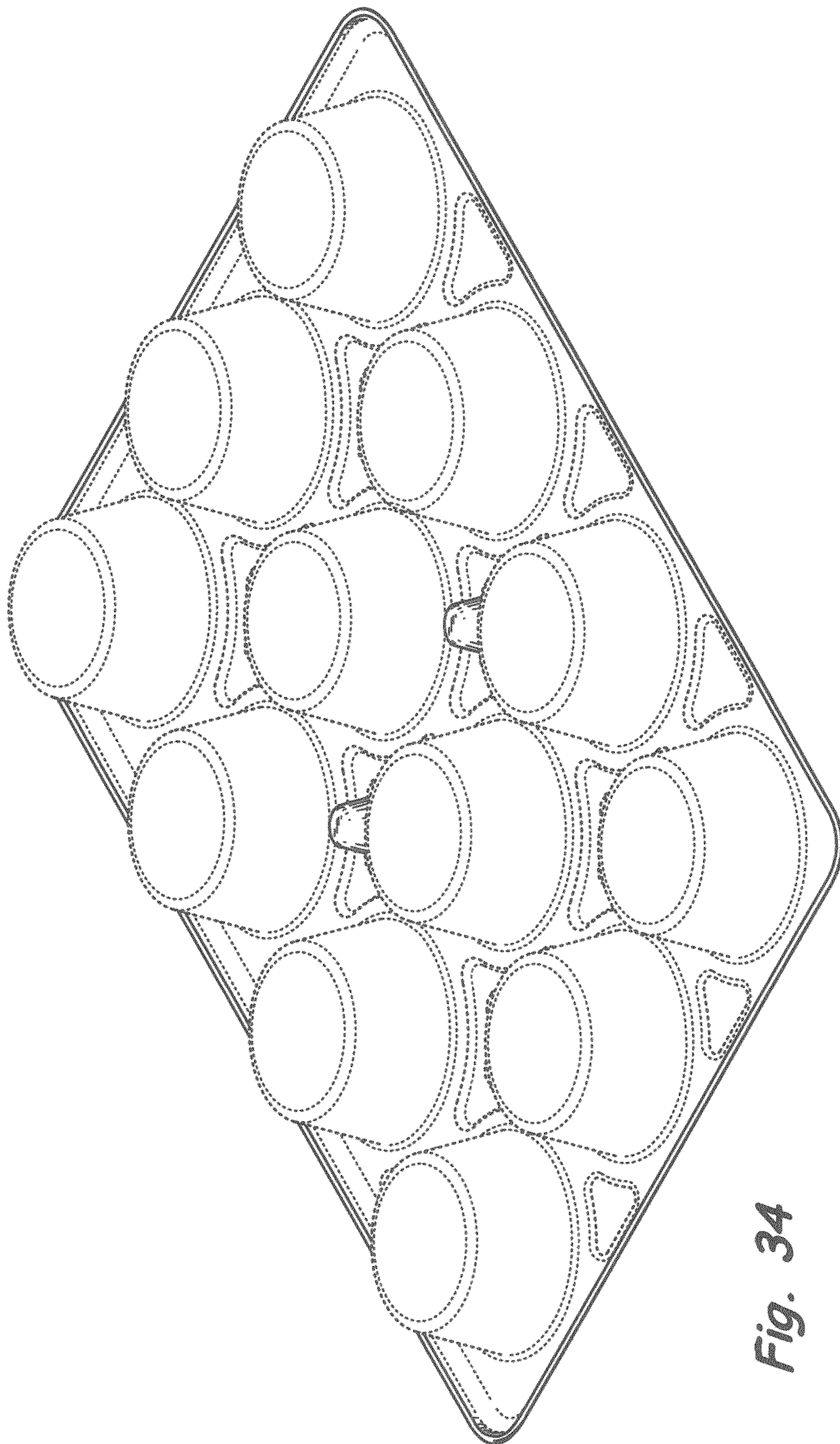

Fig. 34

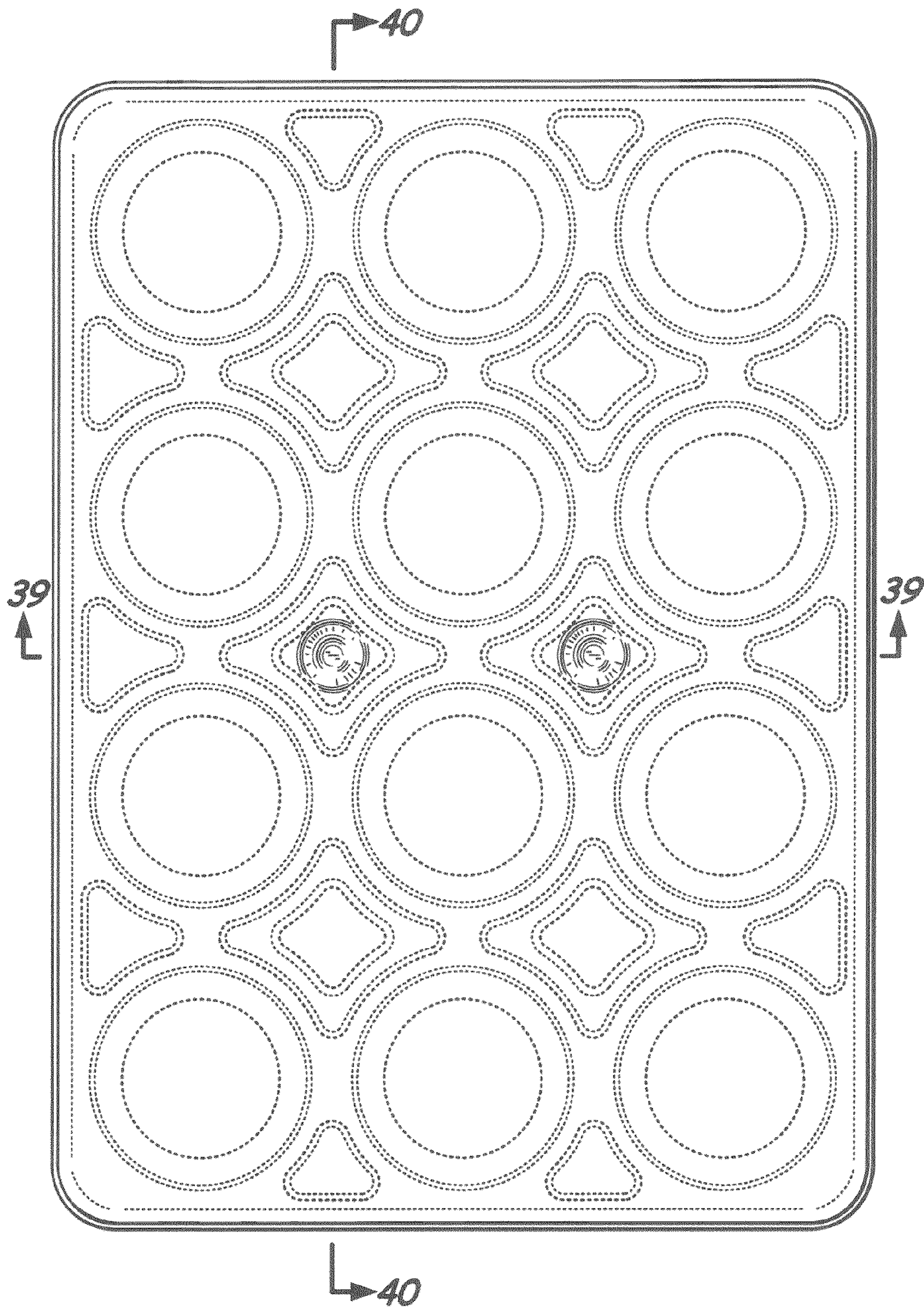

Fig. 35

28/60

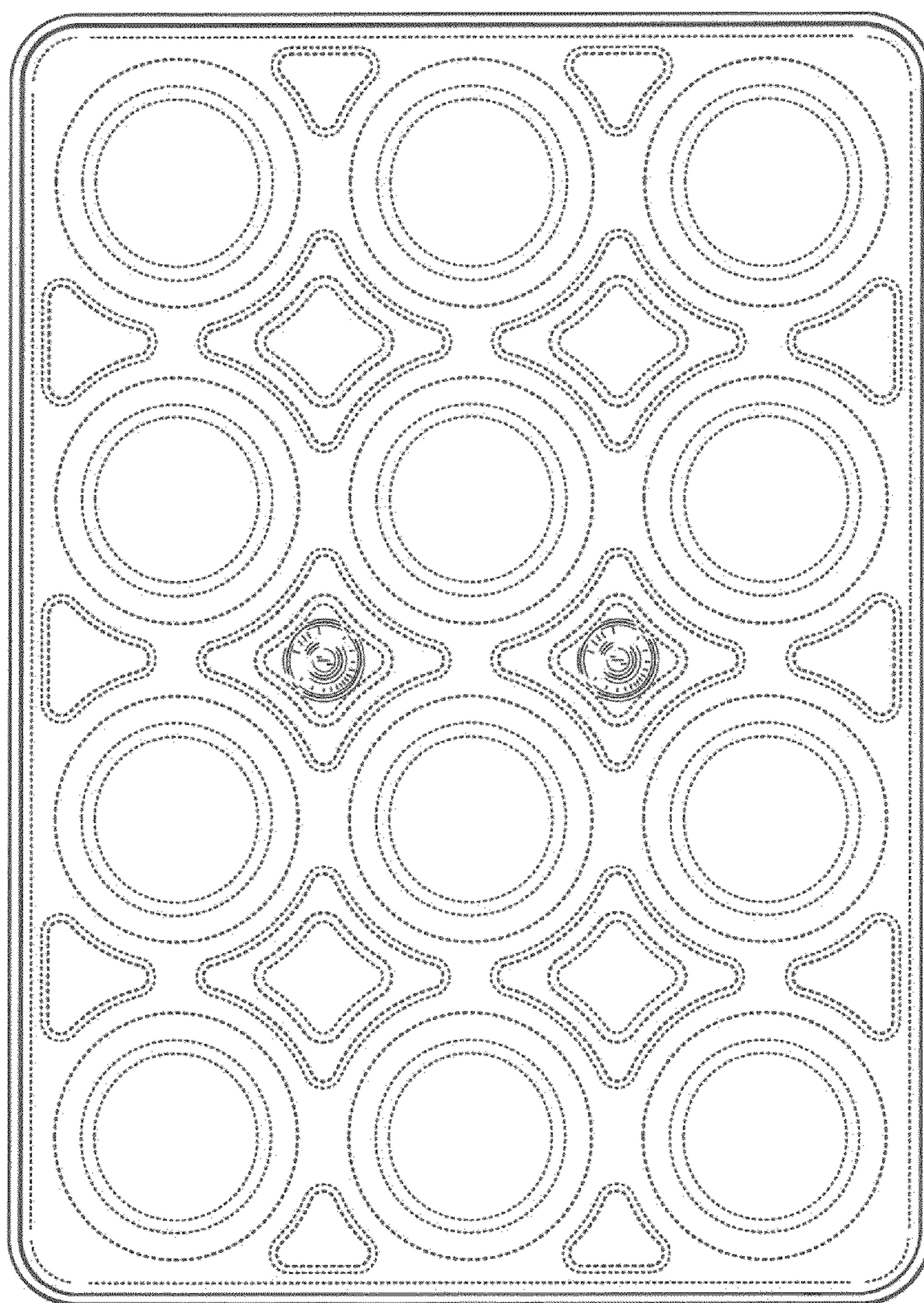

Fig. 36

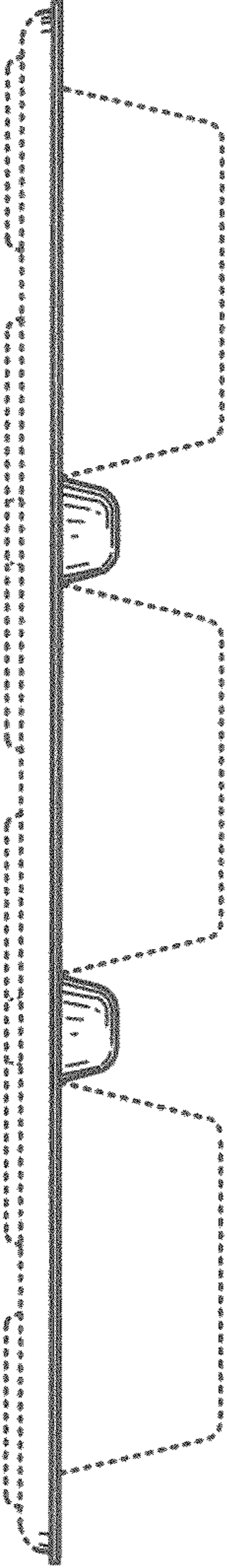

Fig. 37

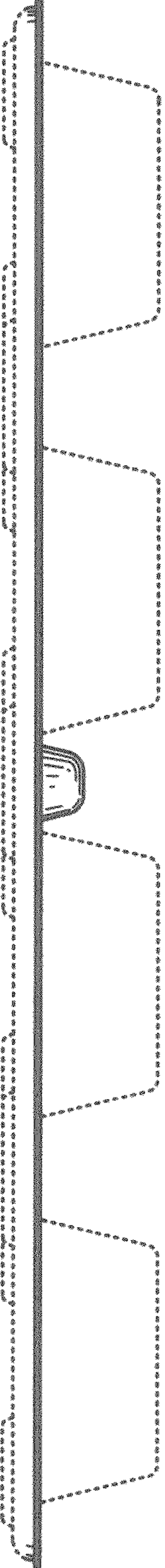

Fig. 38

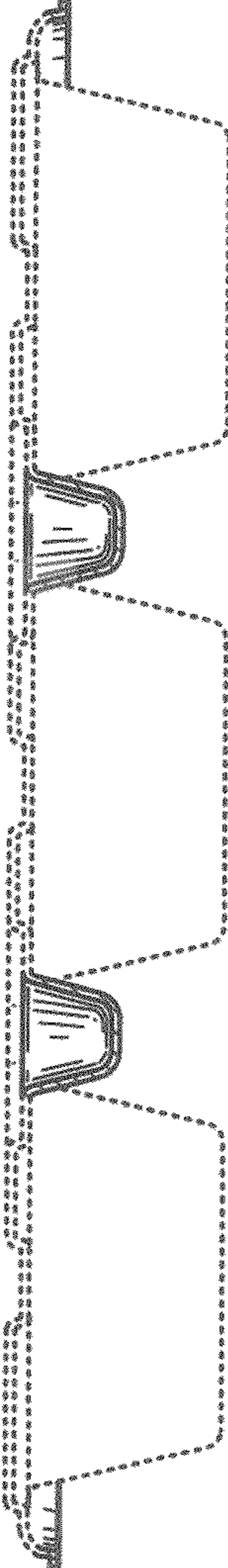

Fig. 39

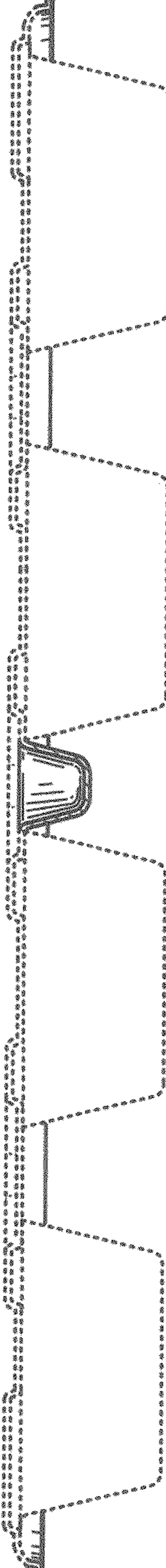

Fig. 40

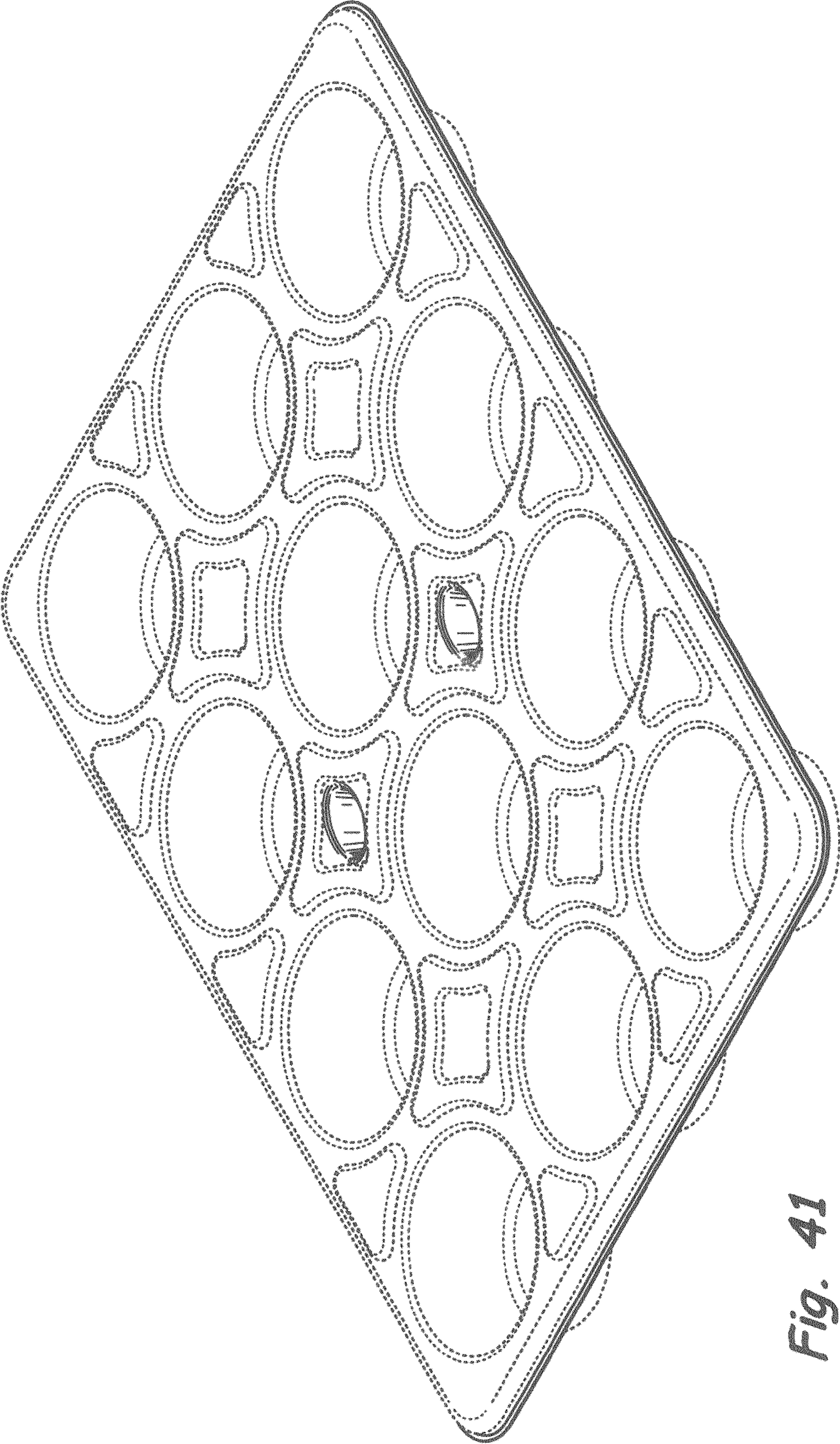

Fig. 41

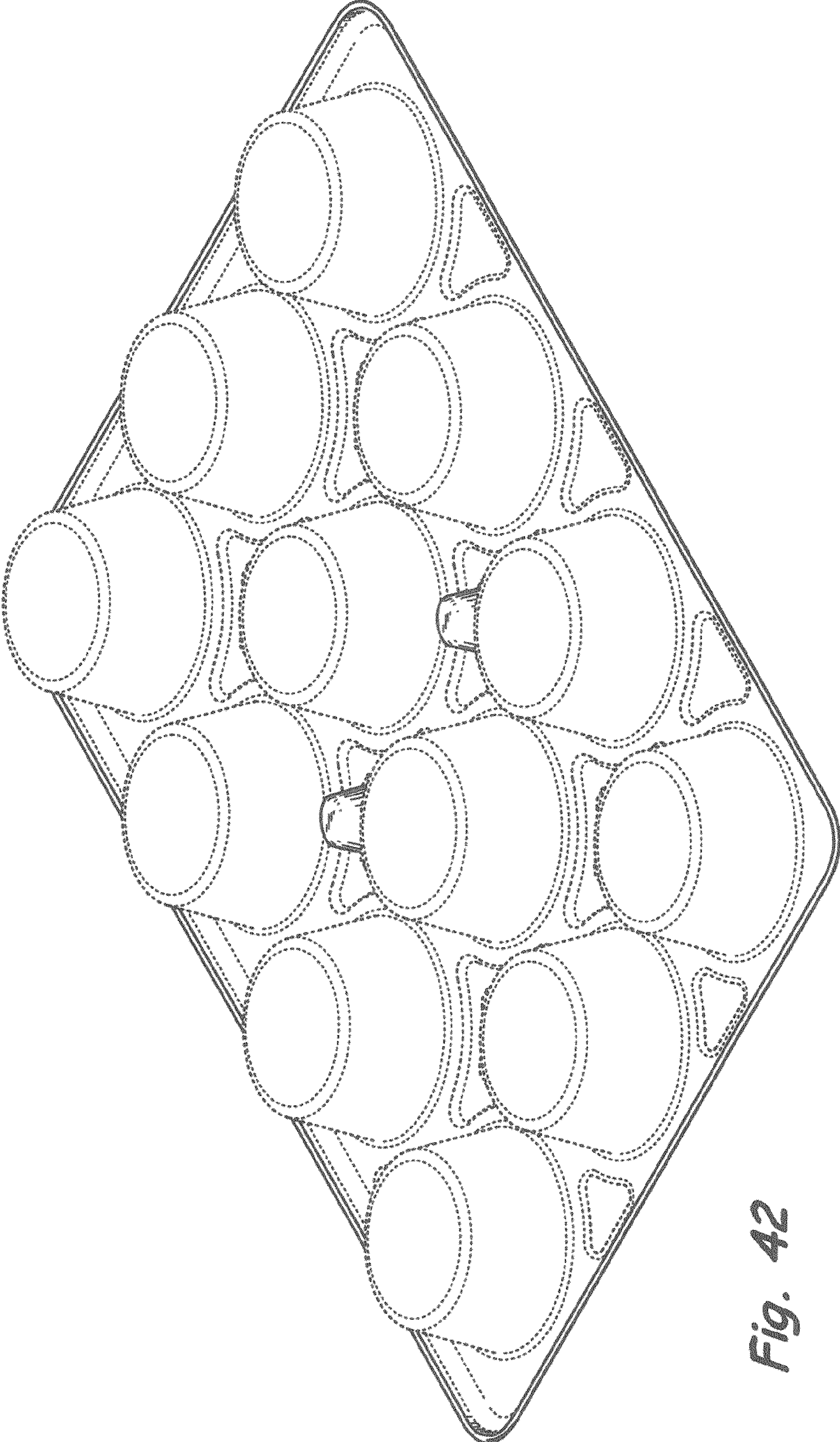

Fig. 42

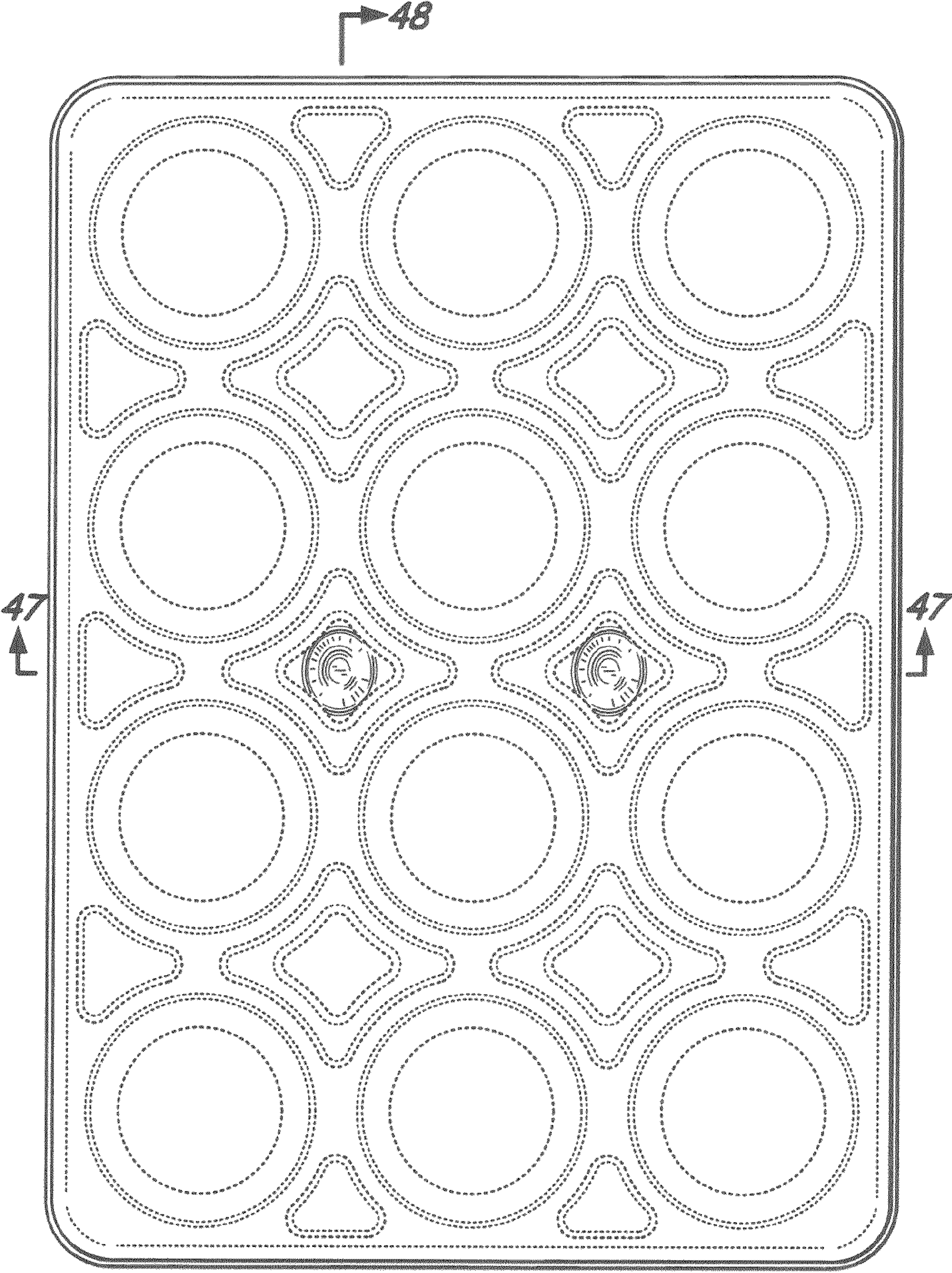

Fig. 43

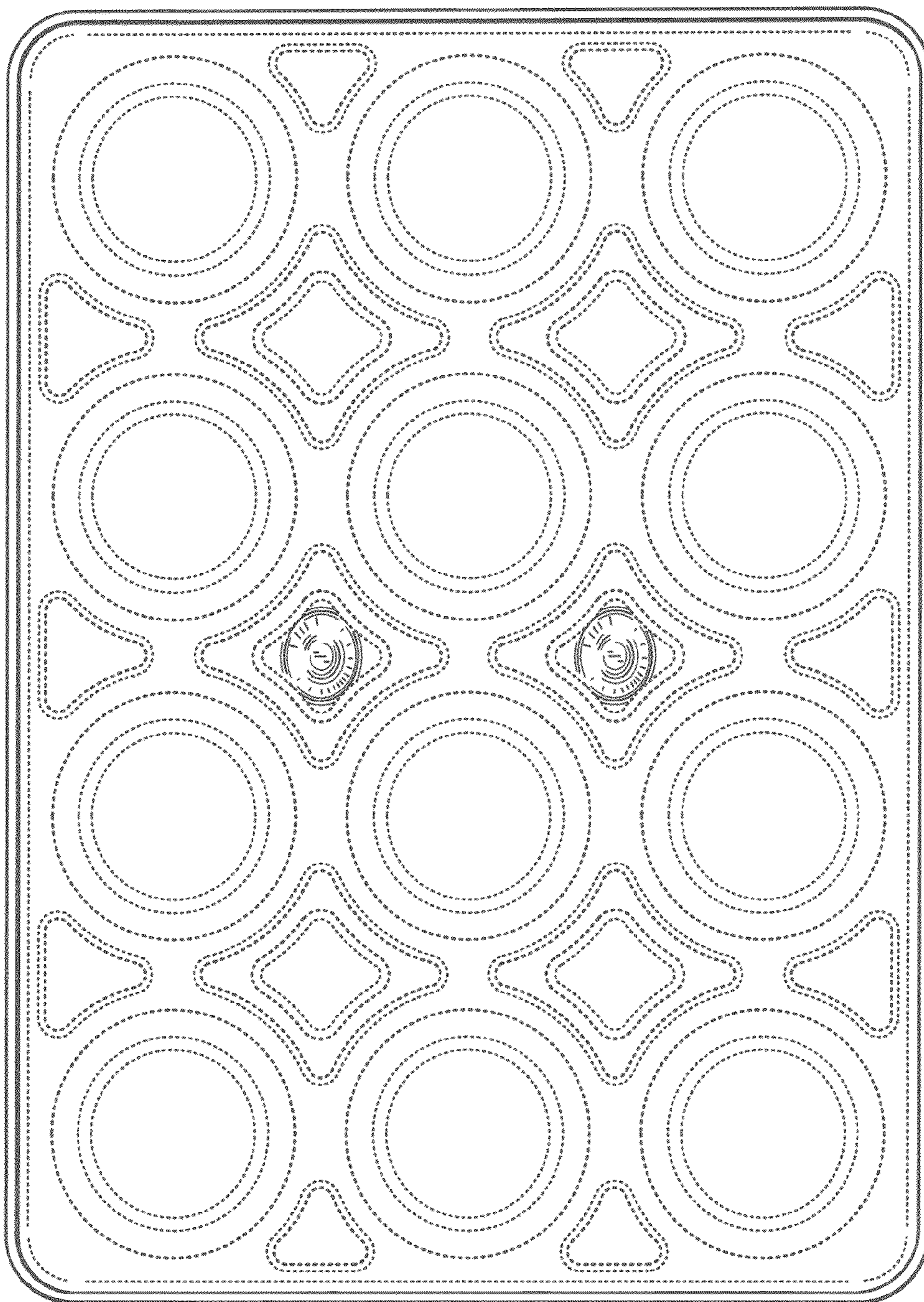

Fig. 44

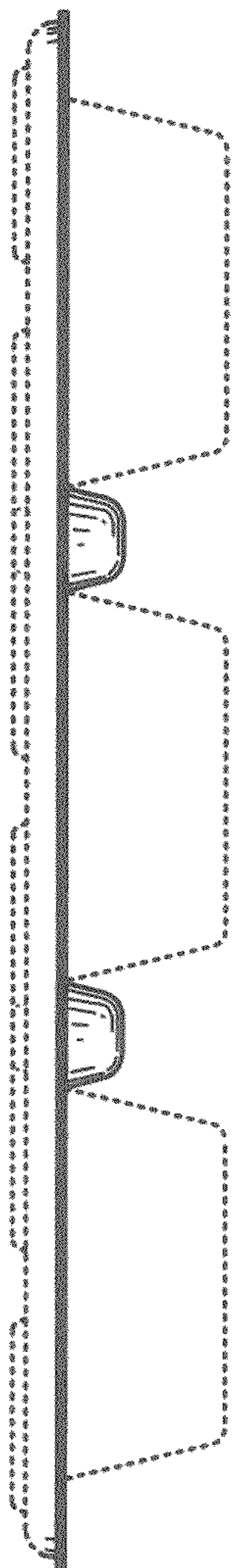

Fig. 45

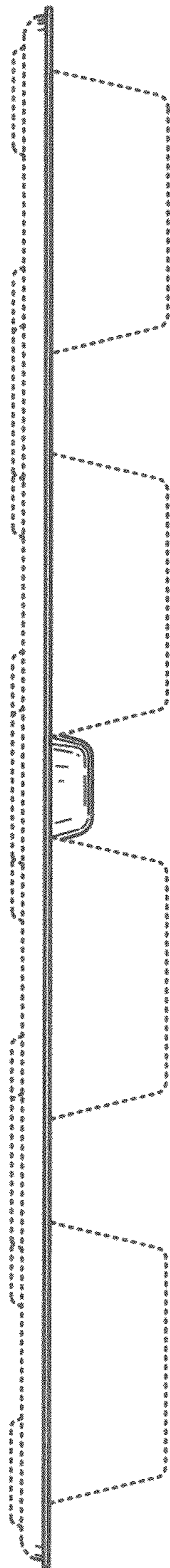

Fig. 46

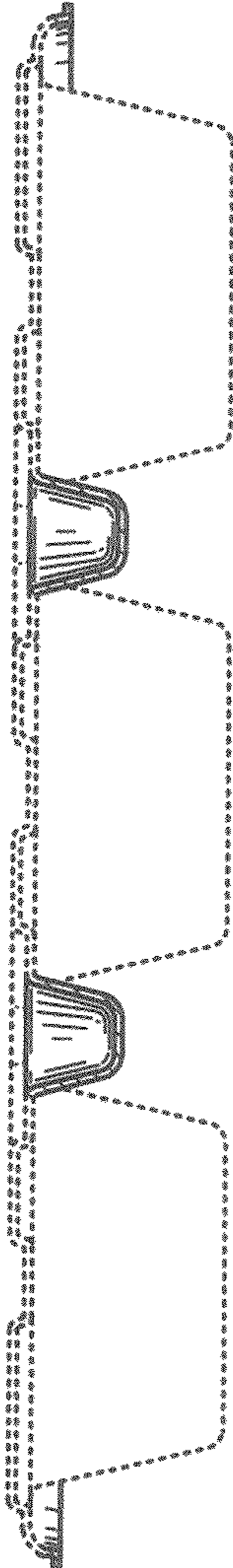

Fig. 47

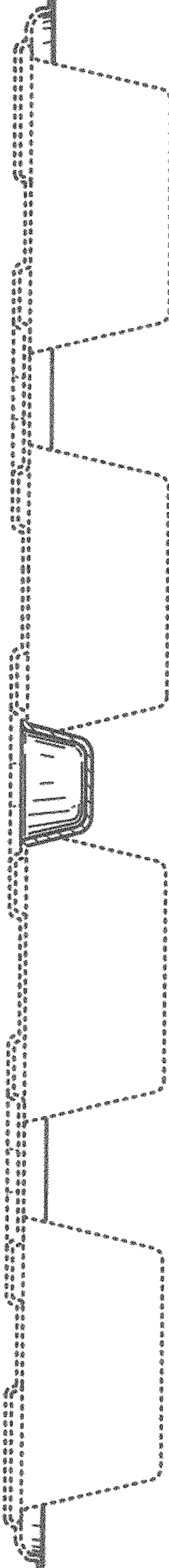

Fig. 48

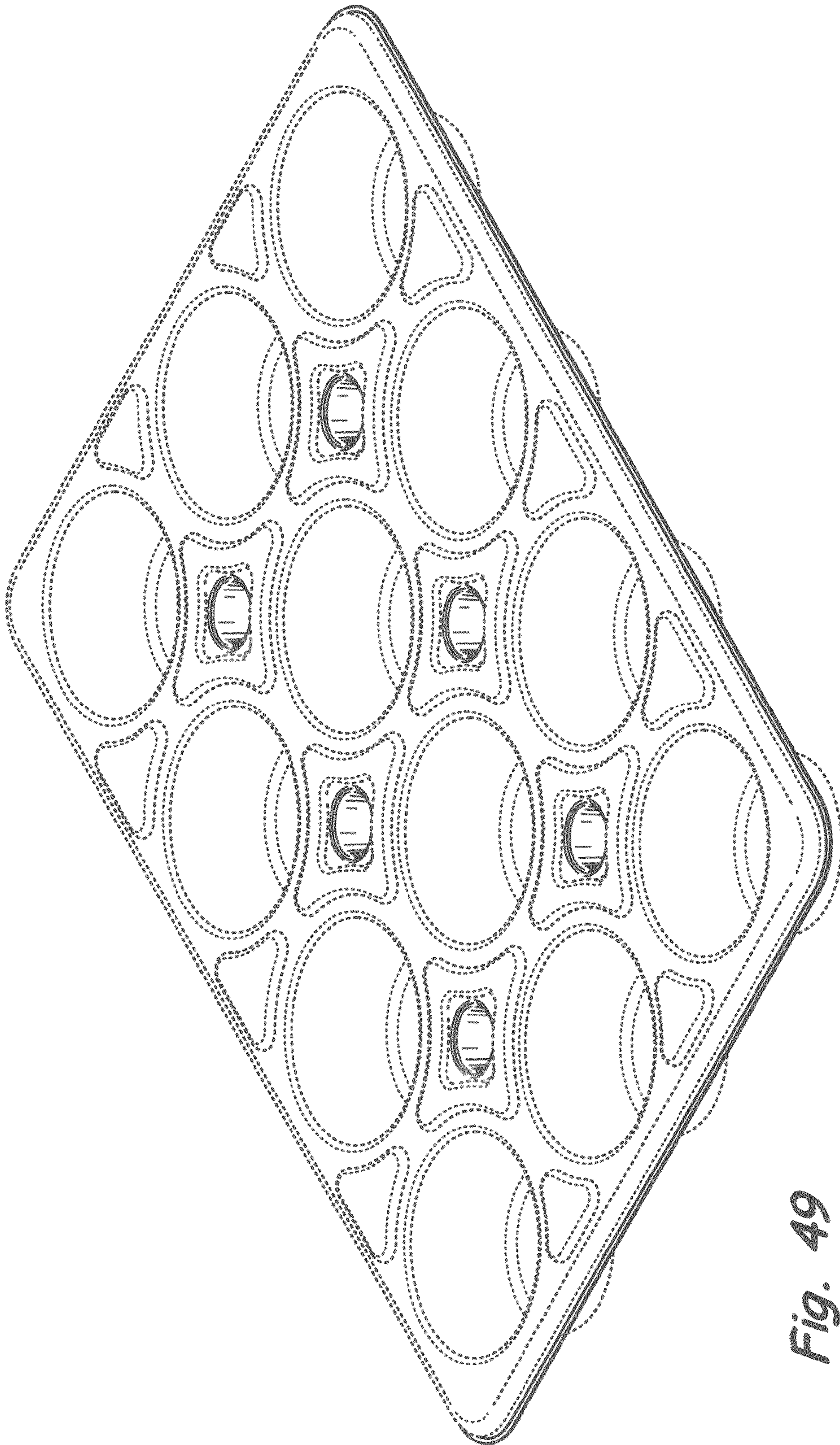

Fig. 49

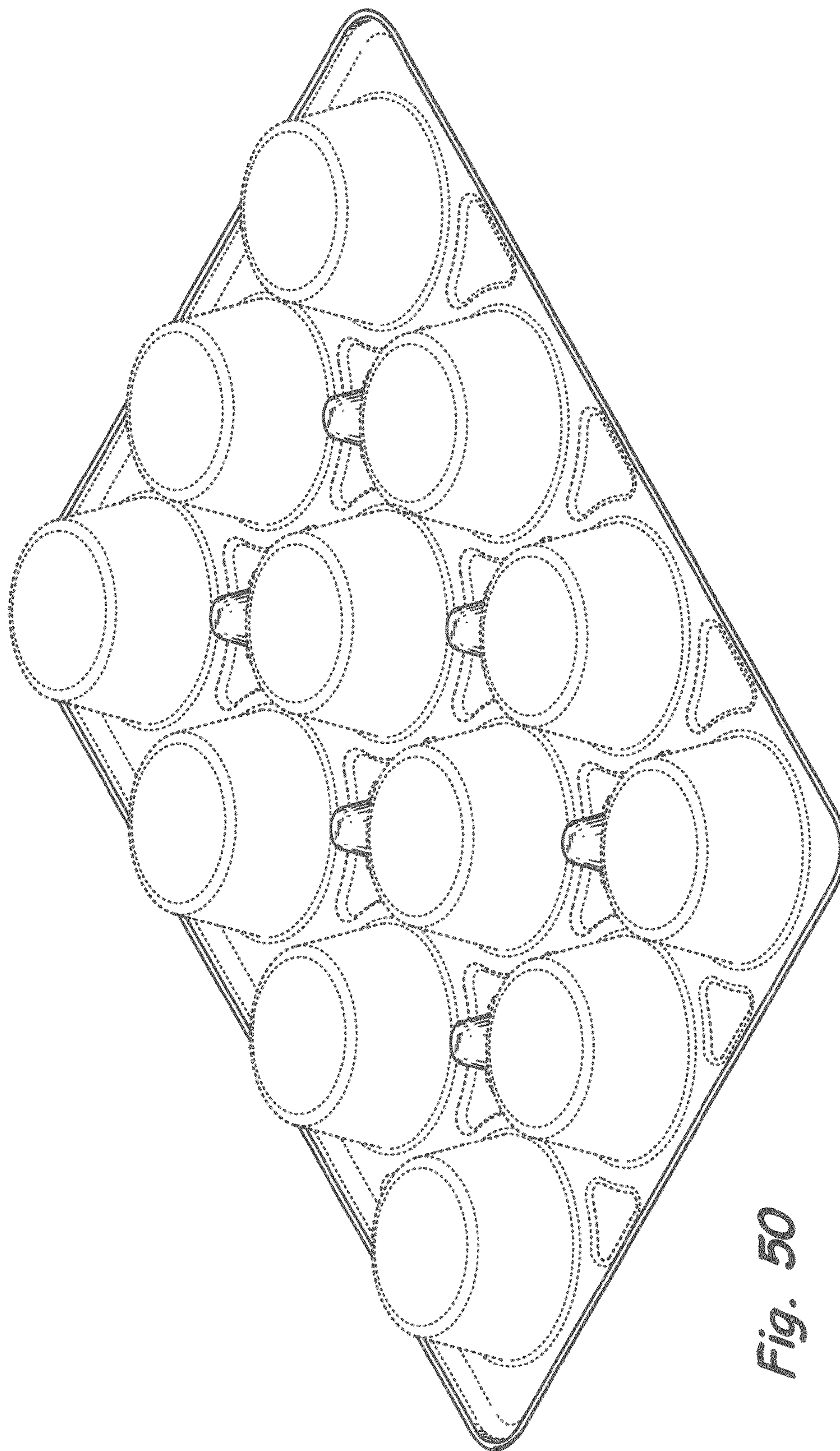

Fig. 50

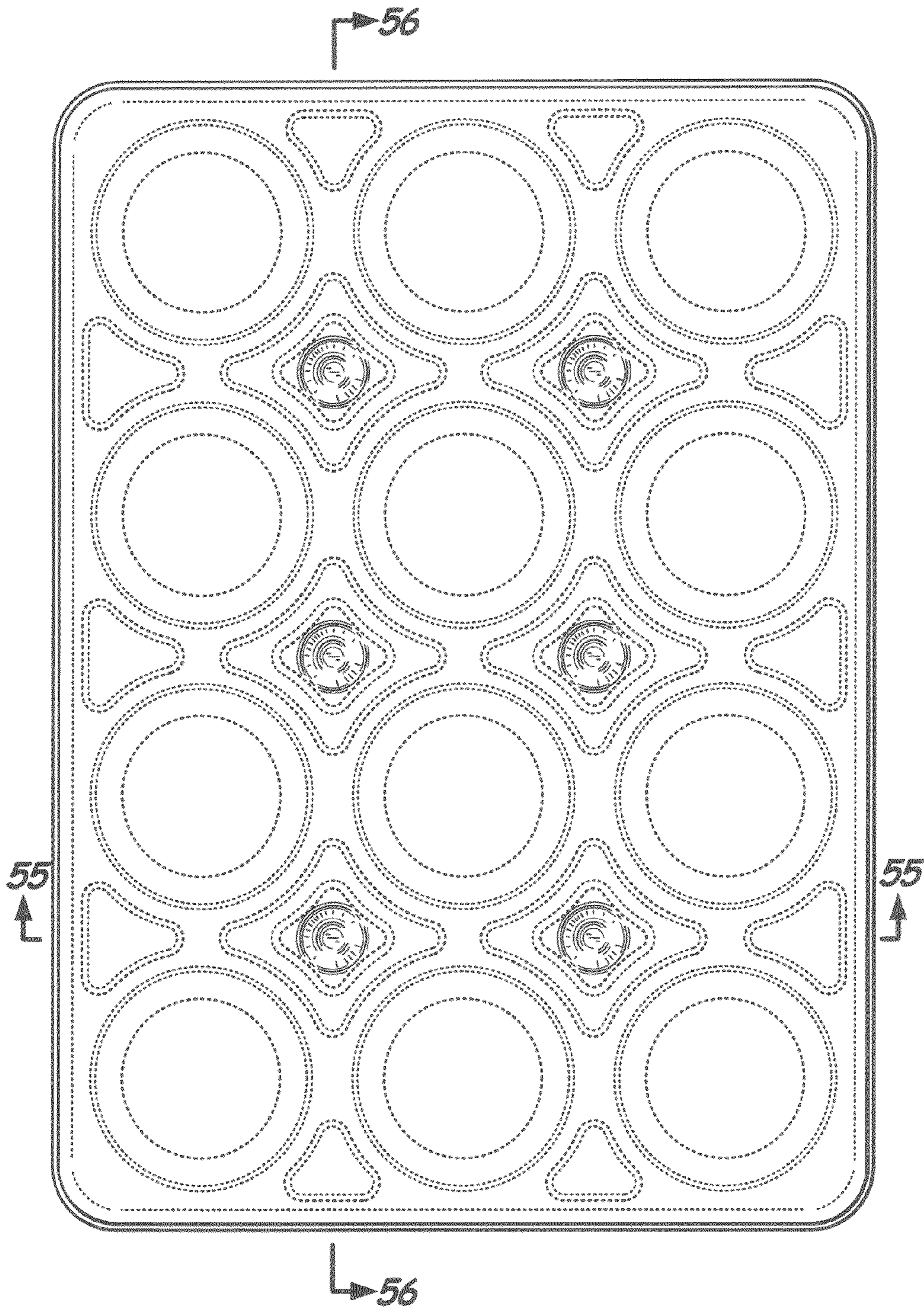

Fig. 51

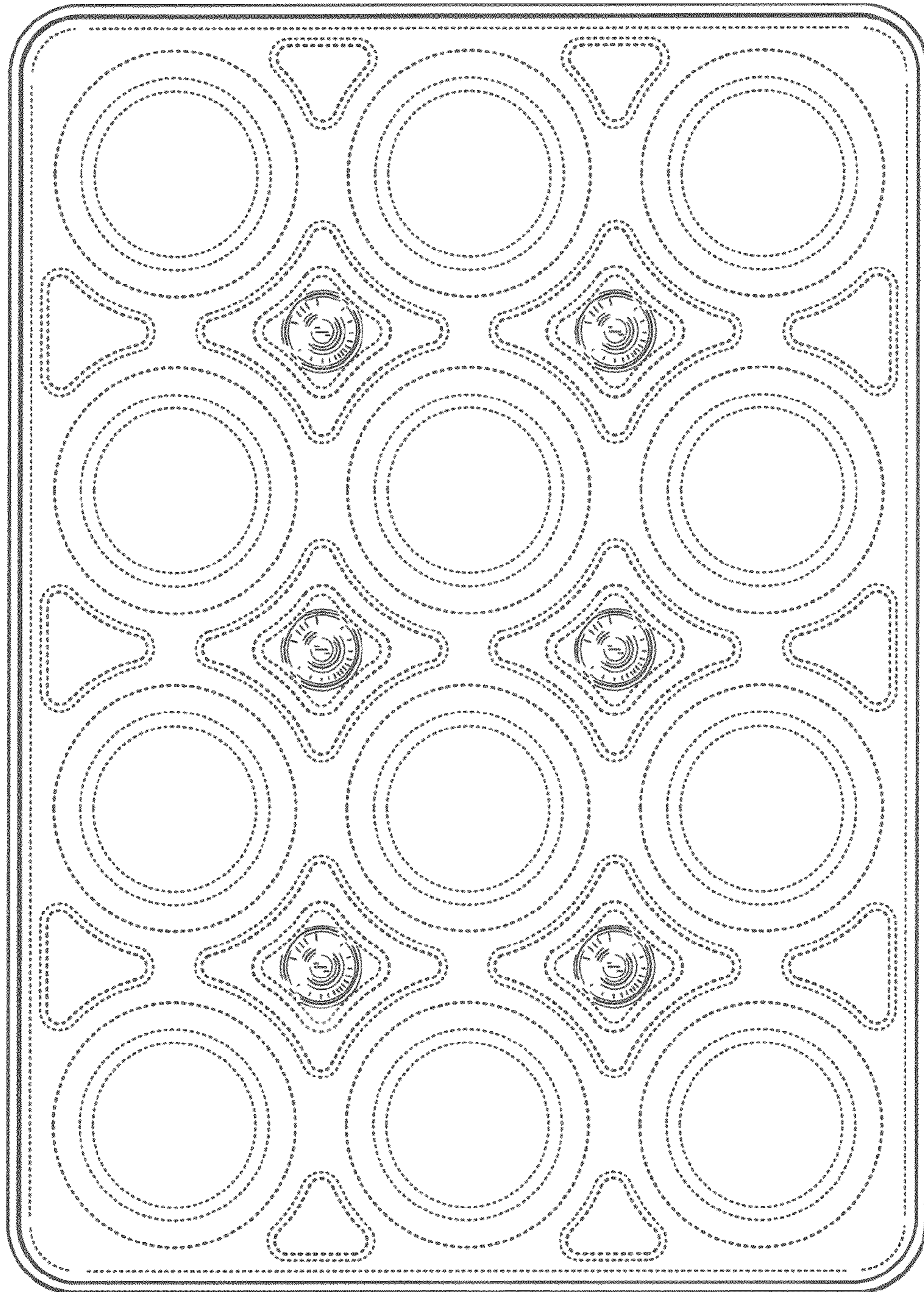

Fig. 52

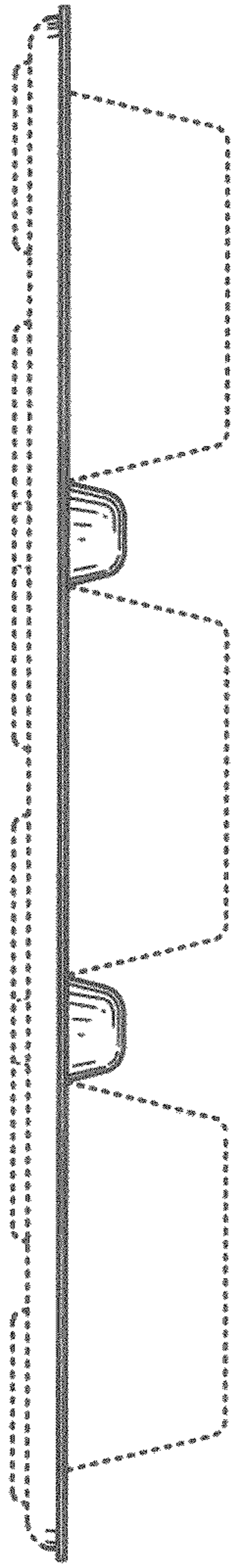

Fig. 53

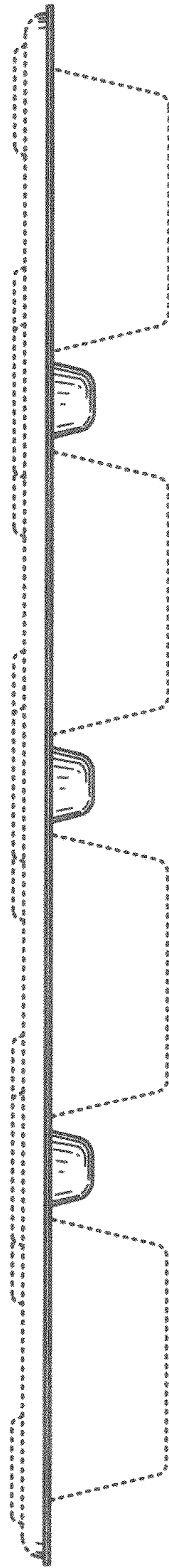

Fig. 54

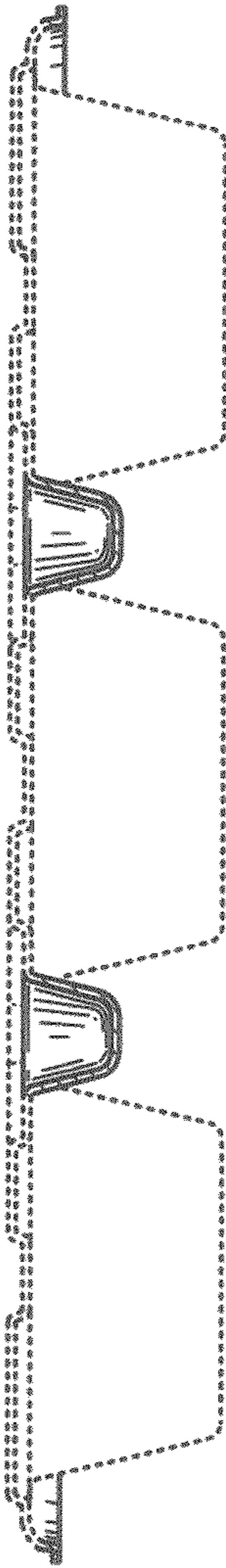

Fig. 55

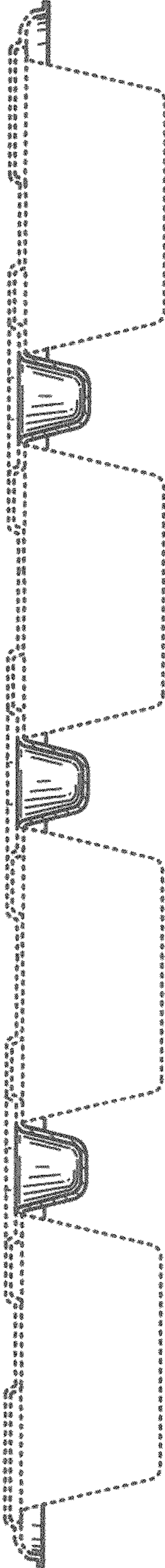

Fig. 56

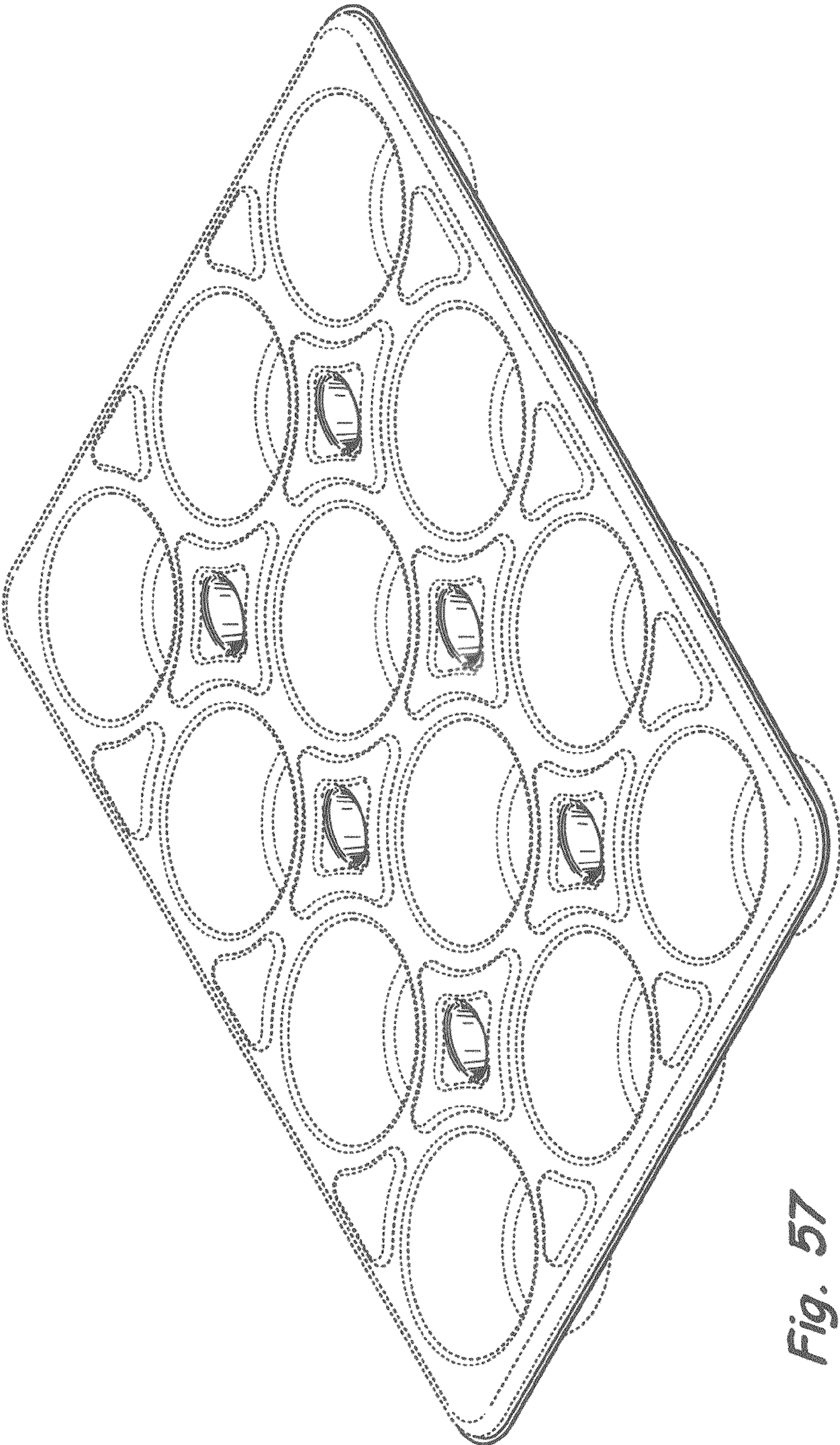

Fig. 57

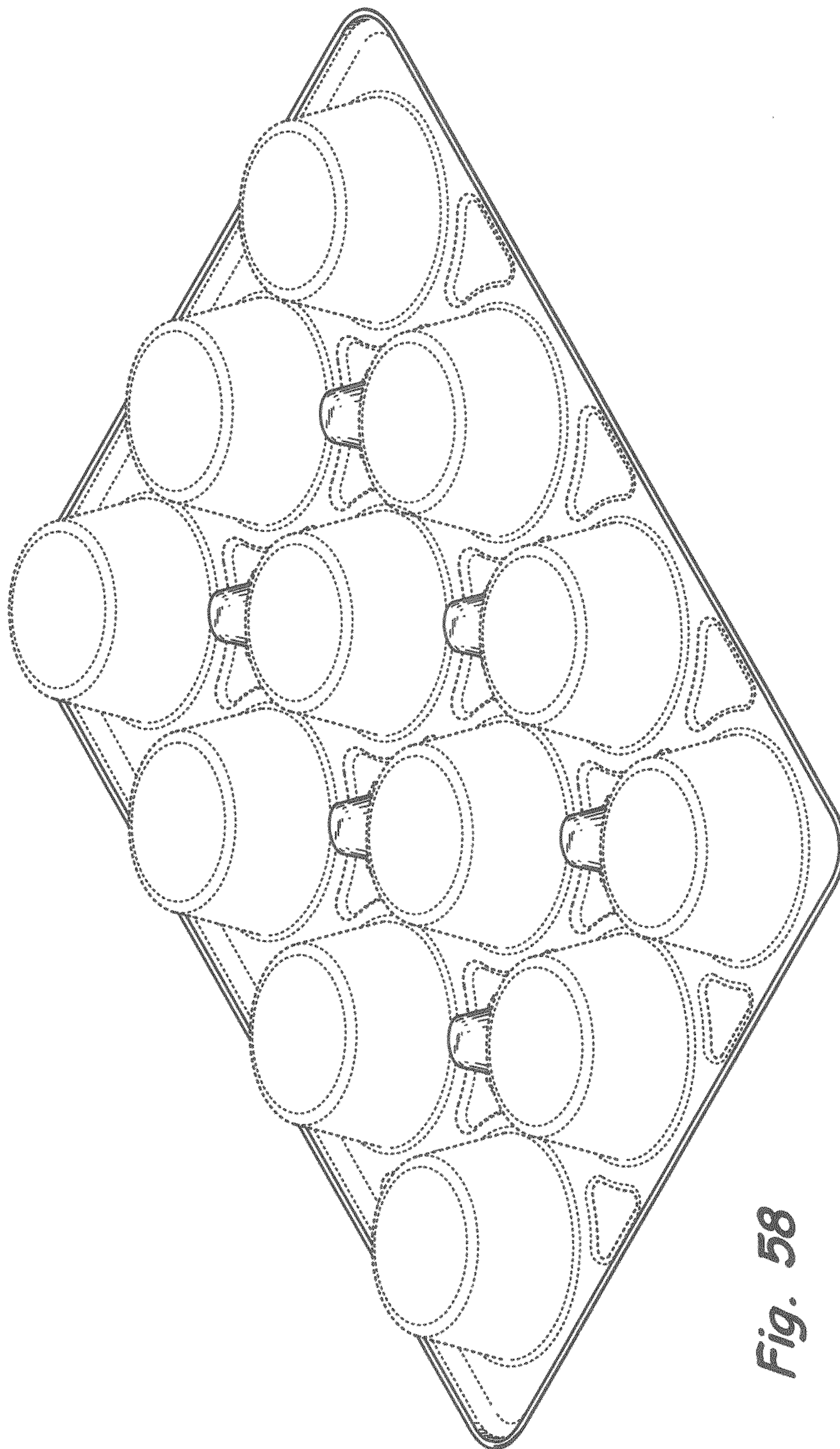

Fig. 58

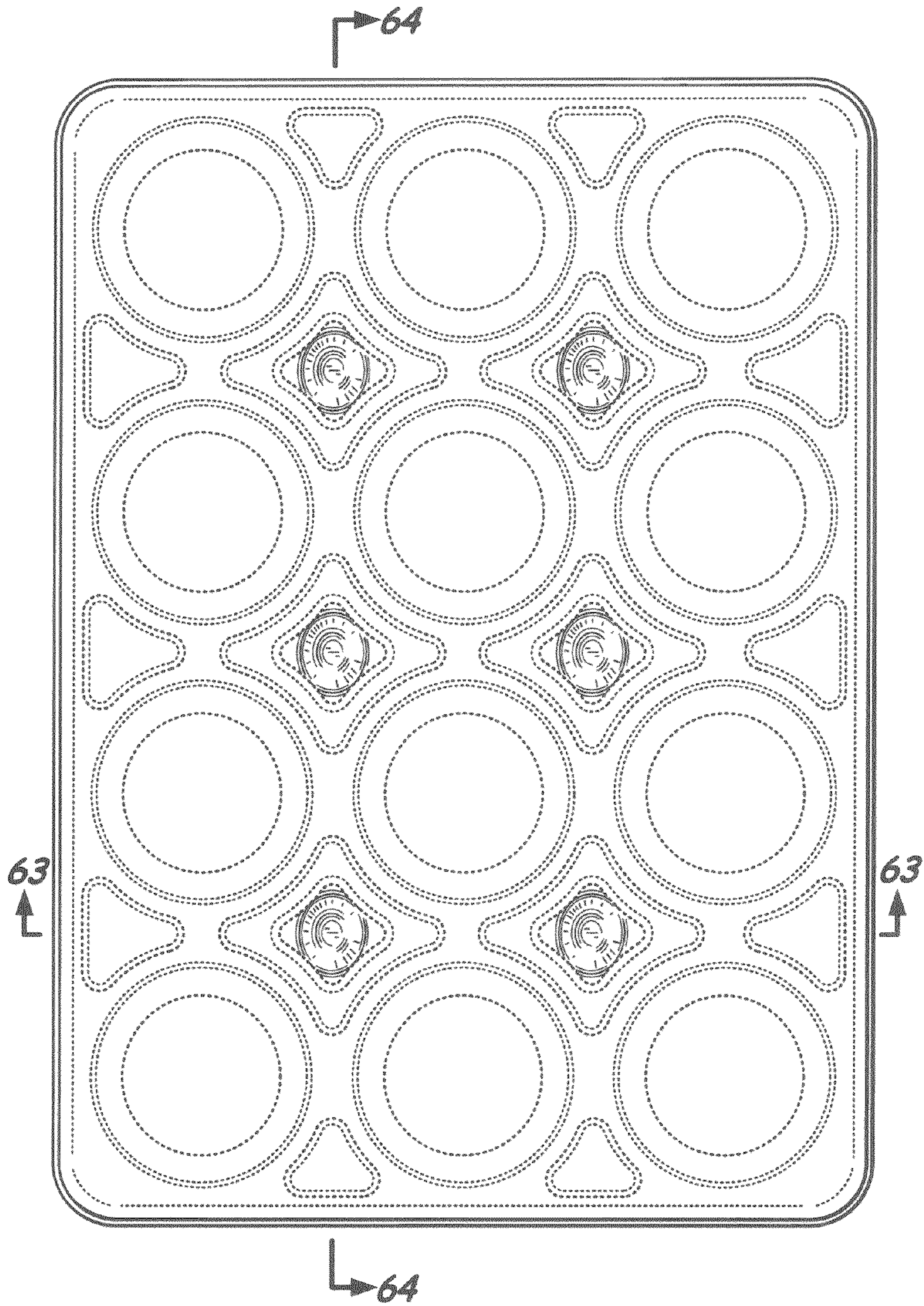

Fig. 59

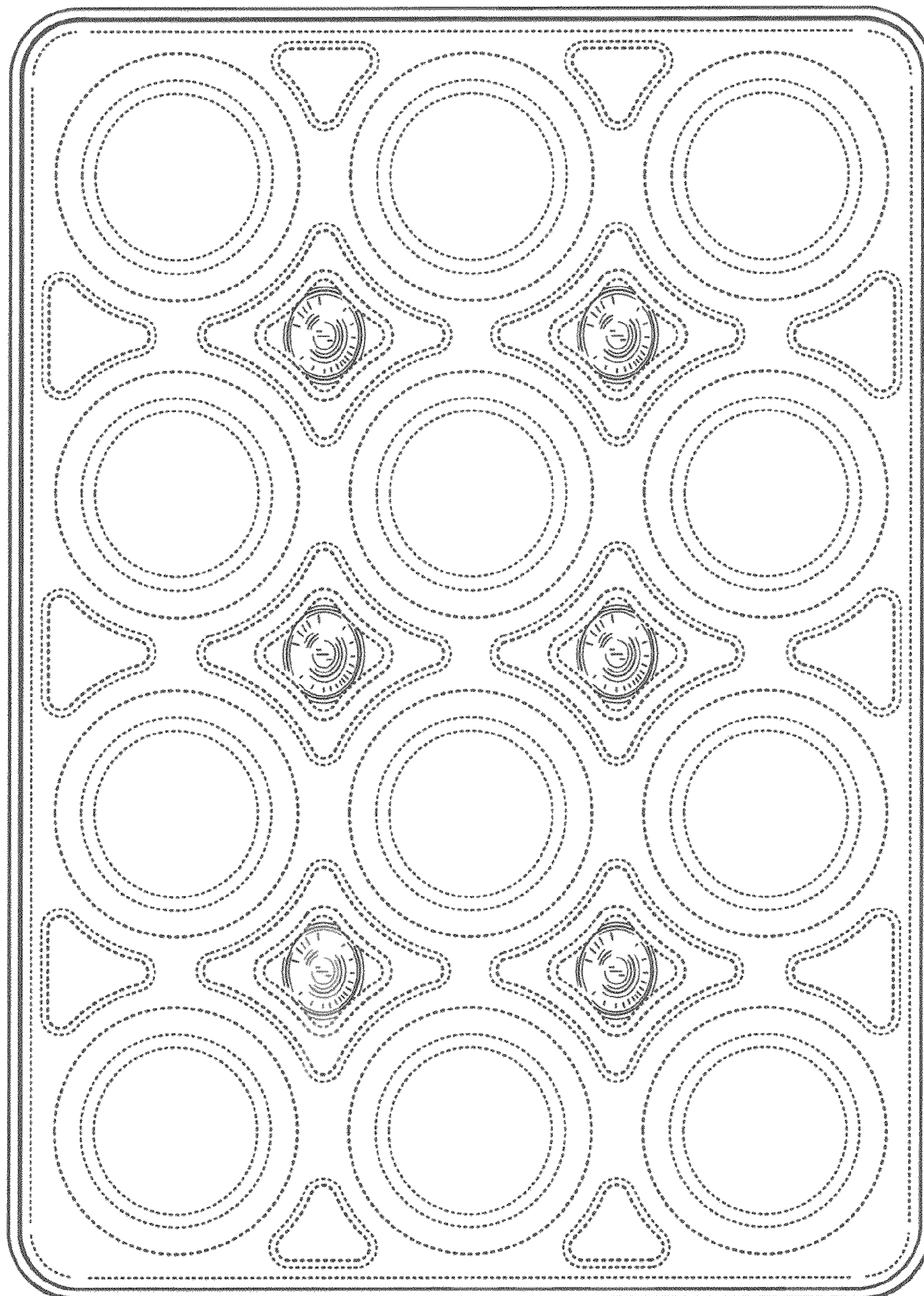

Fig. 60

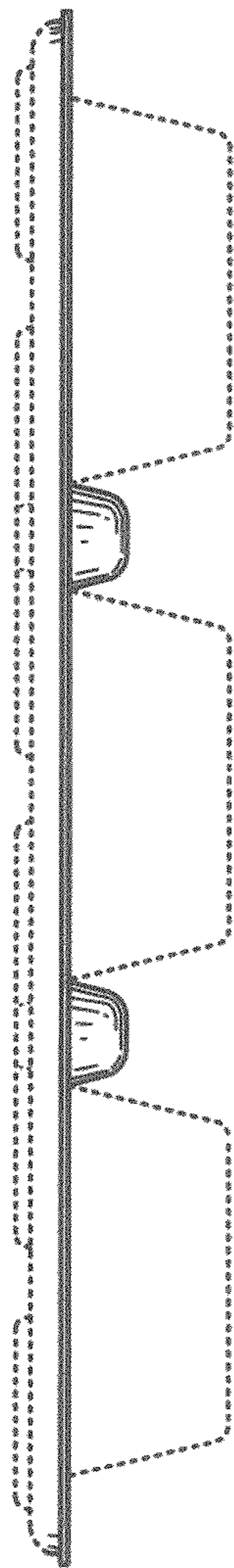

Fig. 61

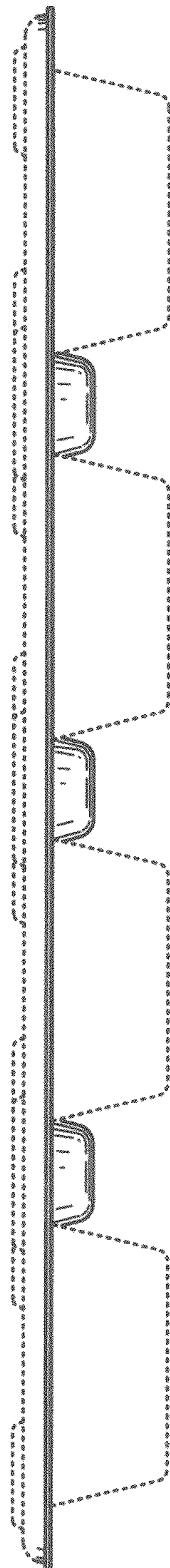

Fig. 62

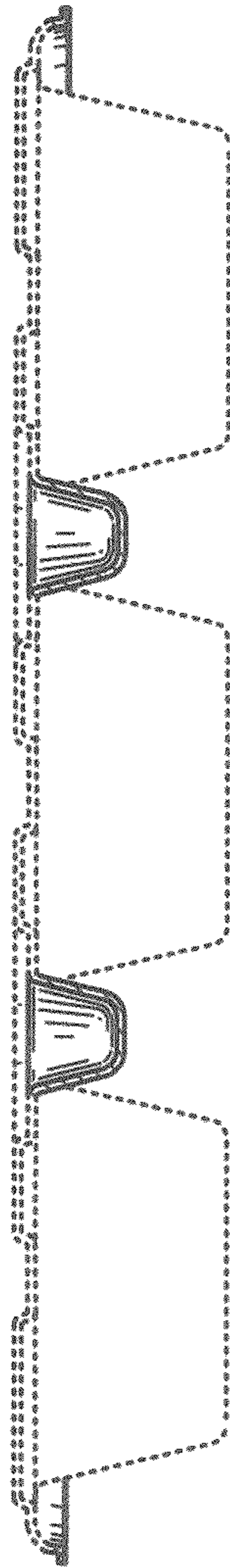

Fig. 63

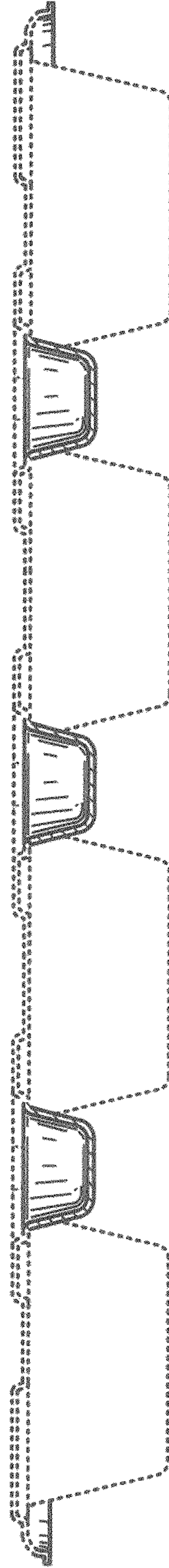

Fig. 64

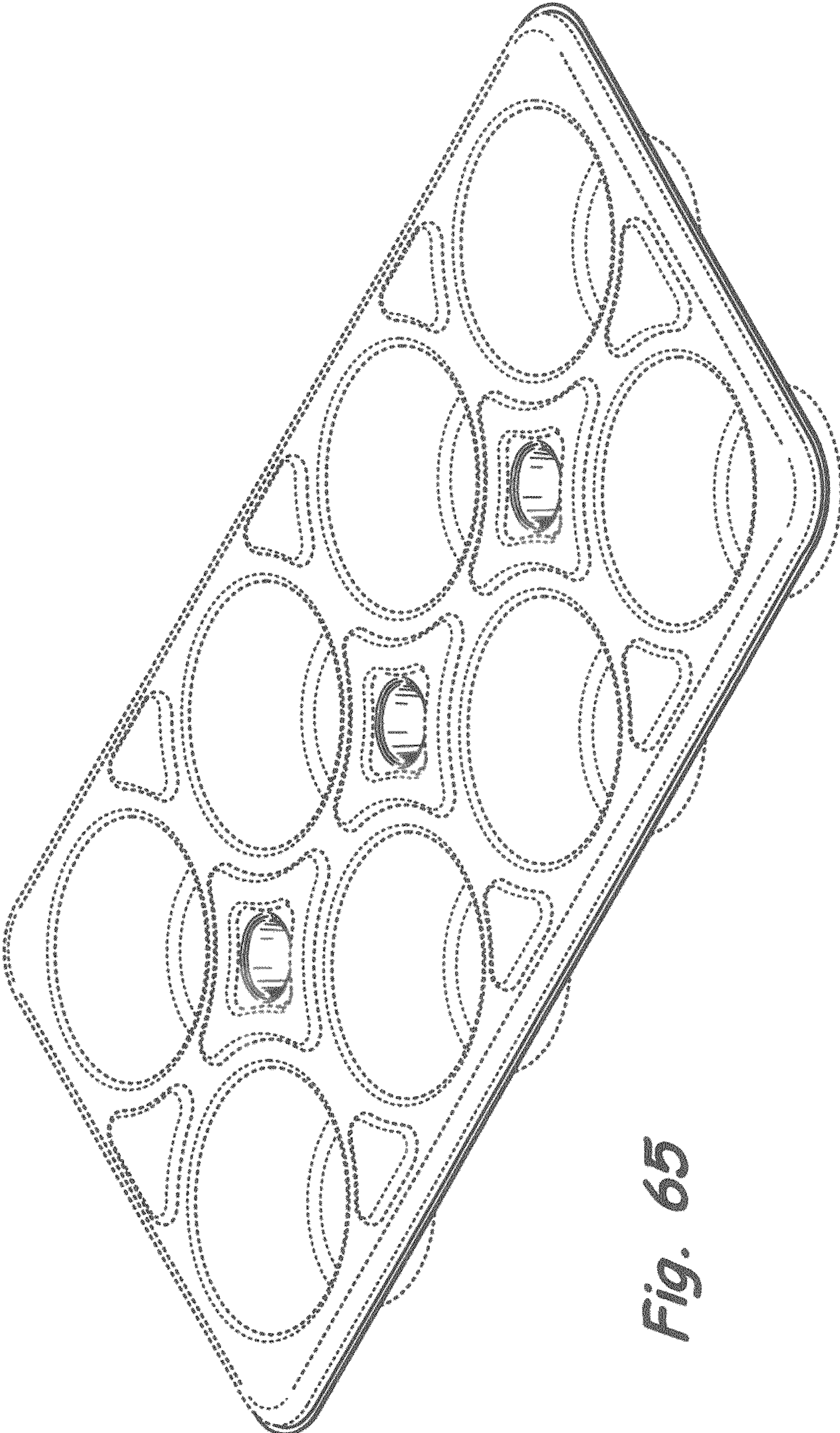

Fig. 65

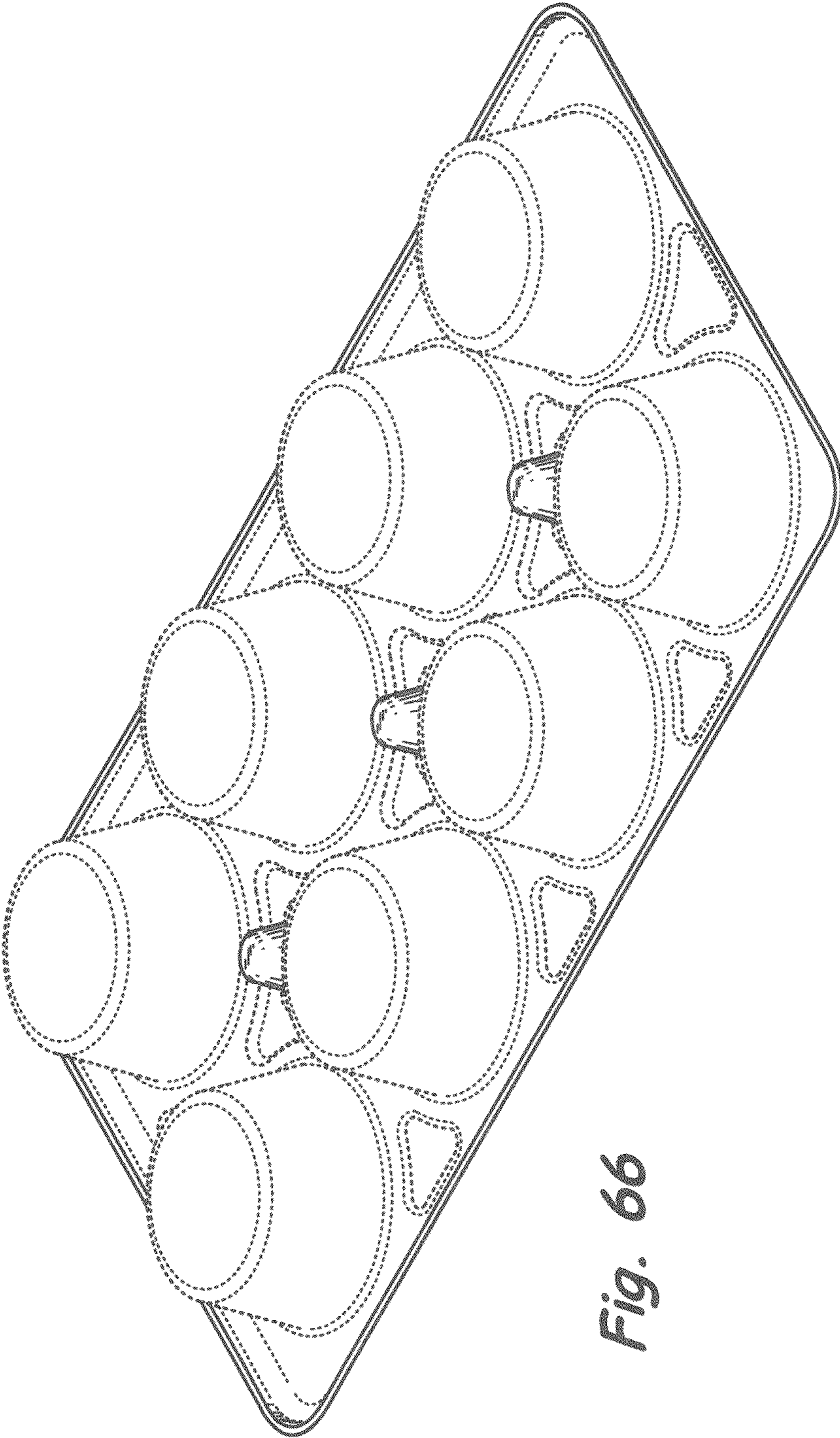

Fig. 66

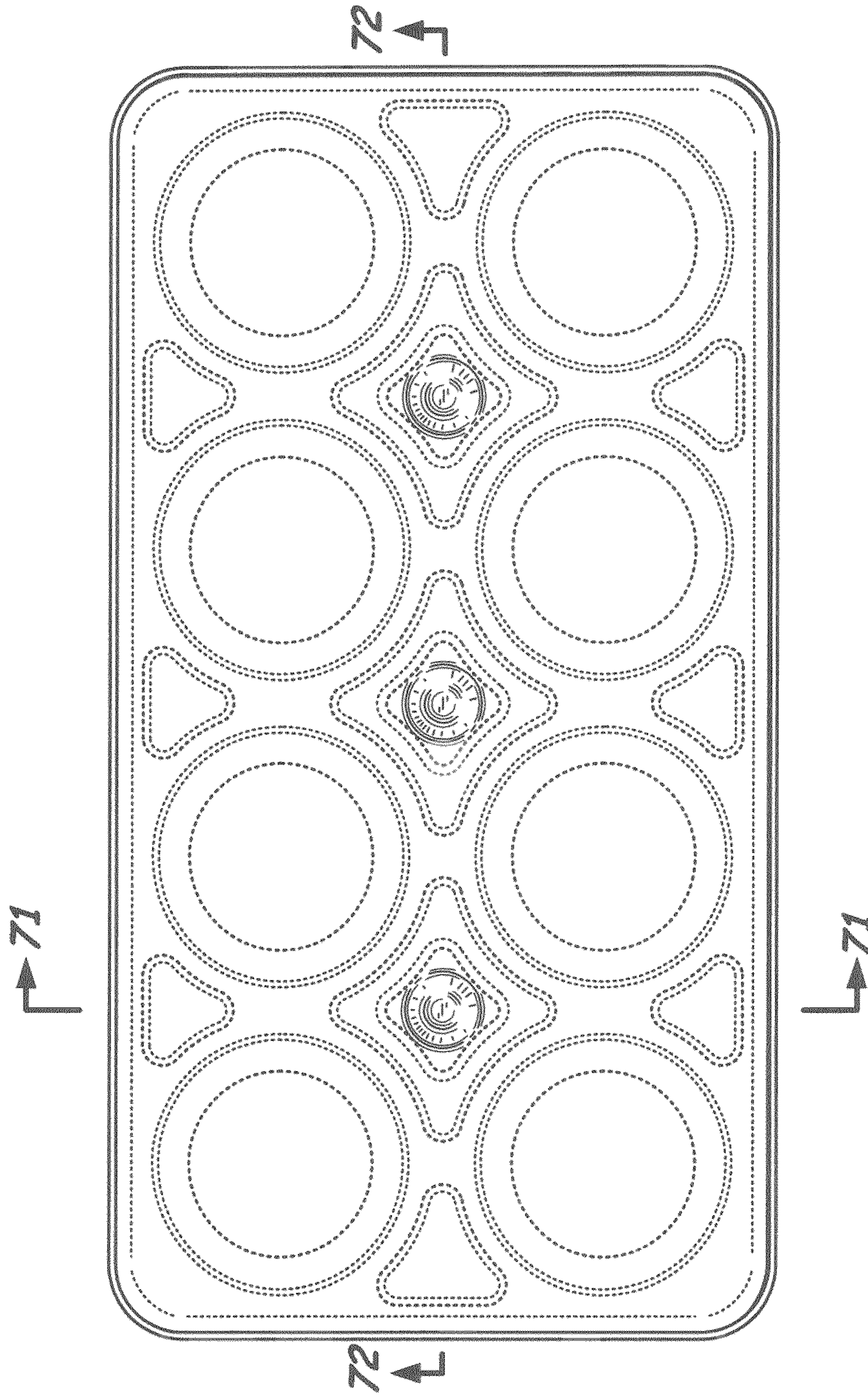

Fig. 67

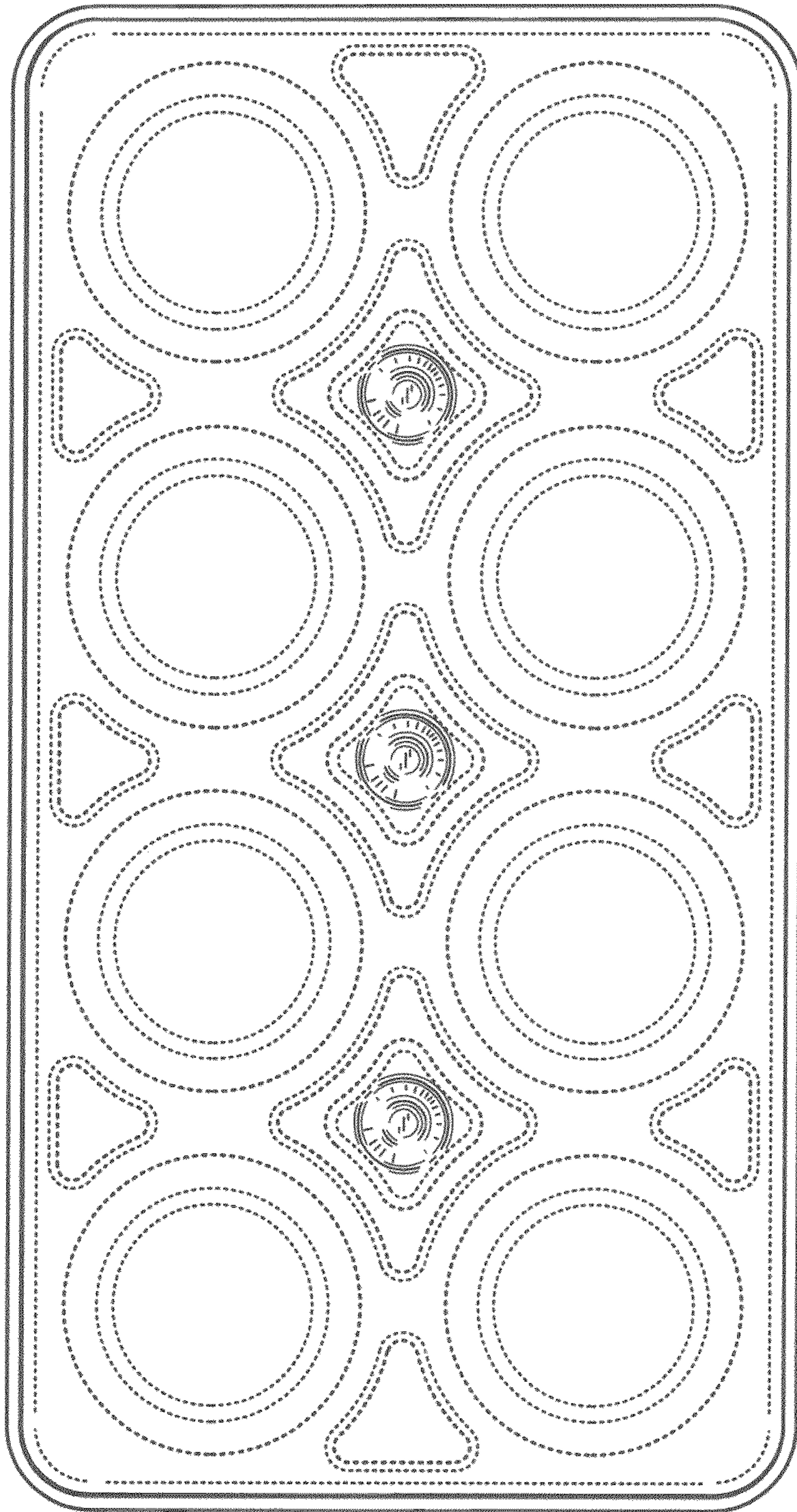

Fig. 68

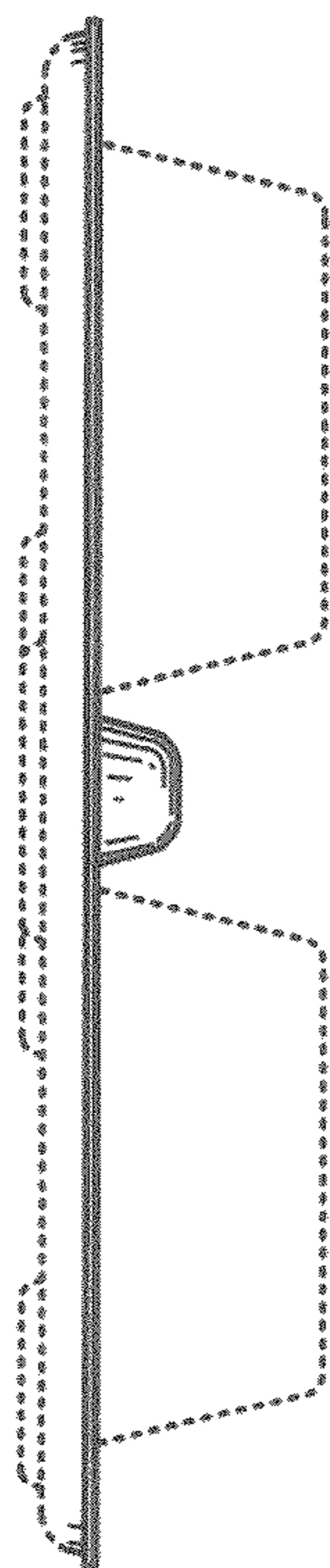

Fig. 69

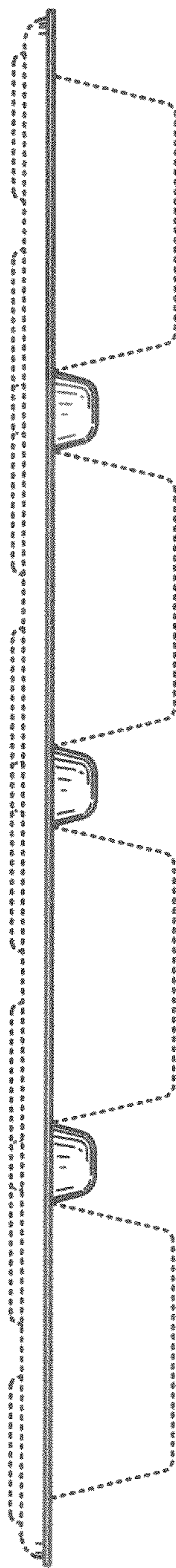

Fig. 70

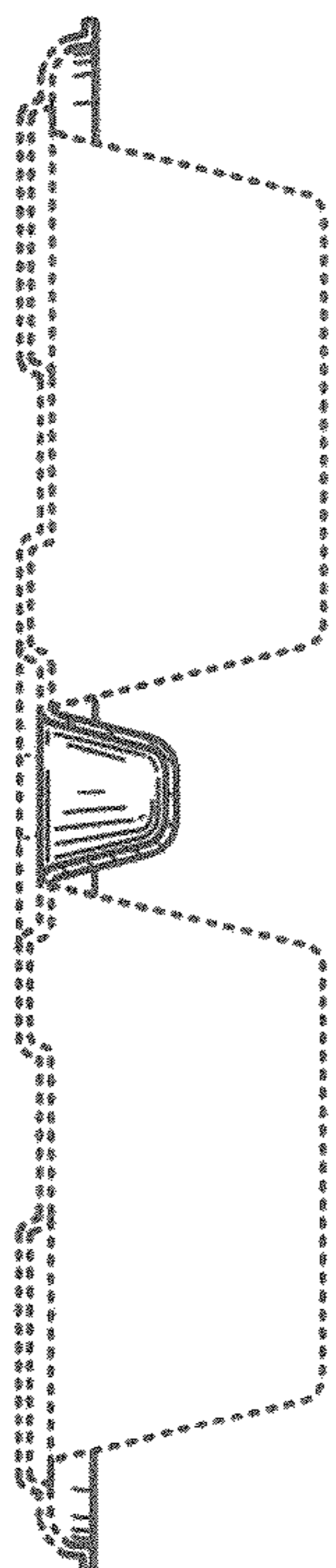

Fig. 71

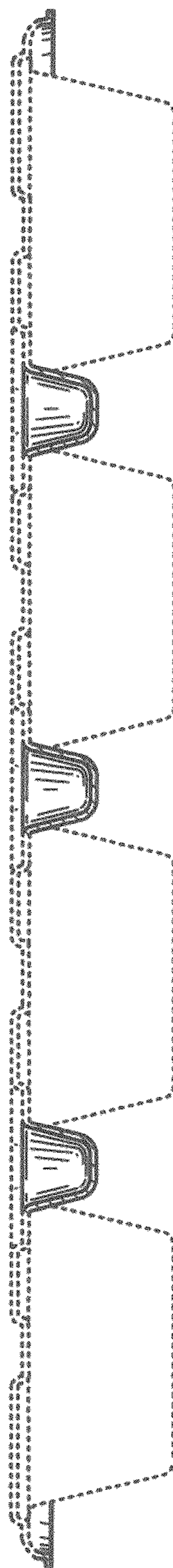

Fig. 72

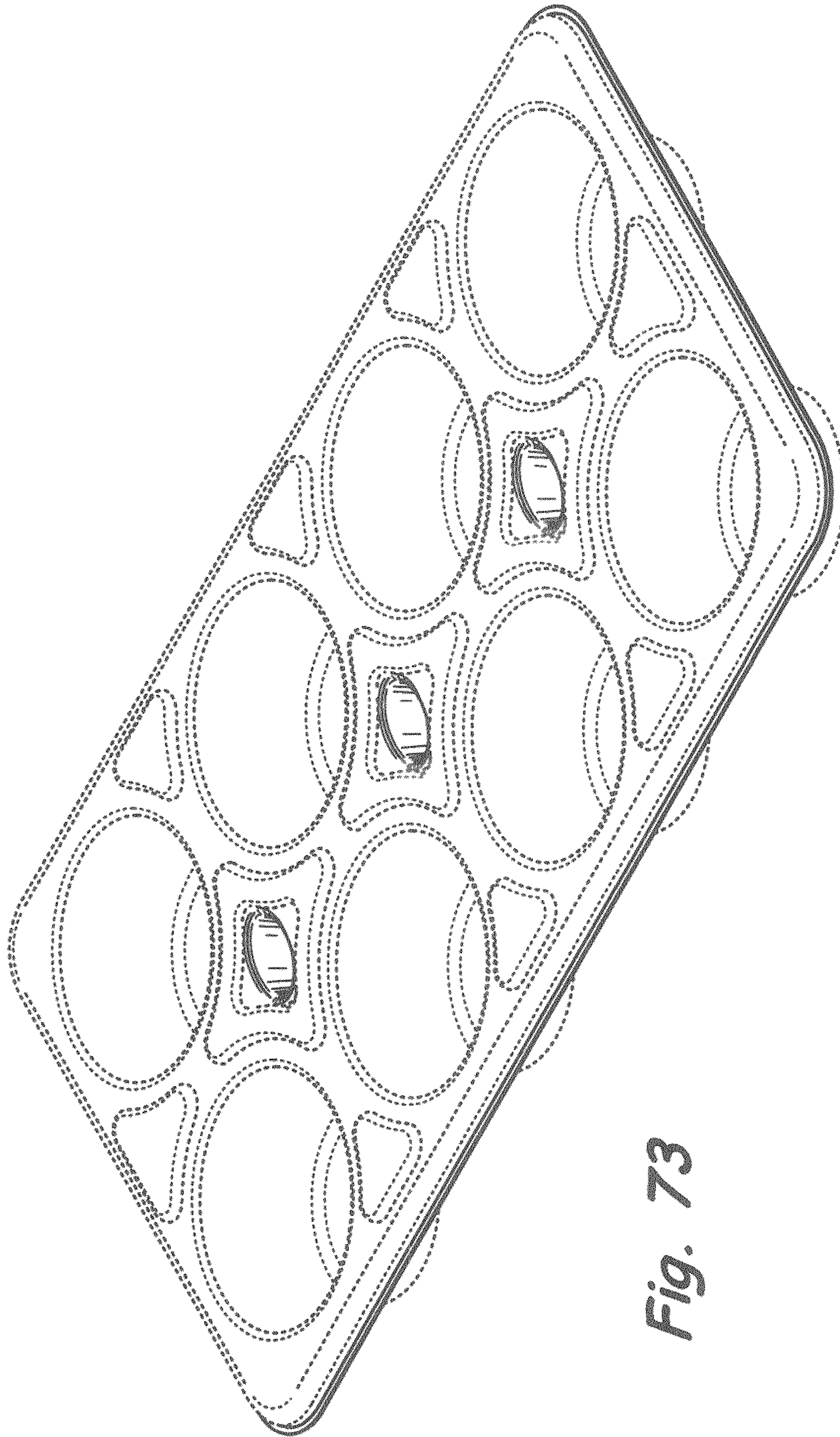

Fig. 73

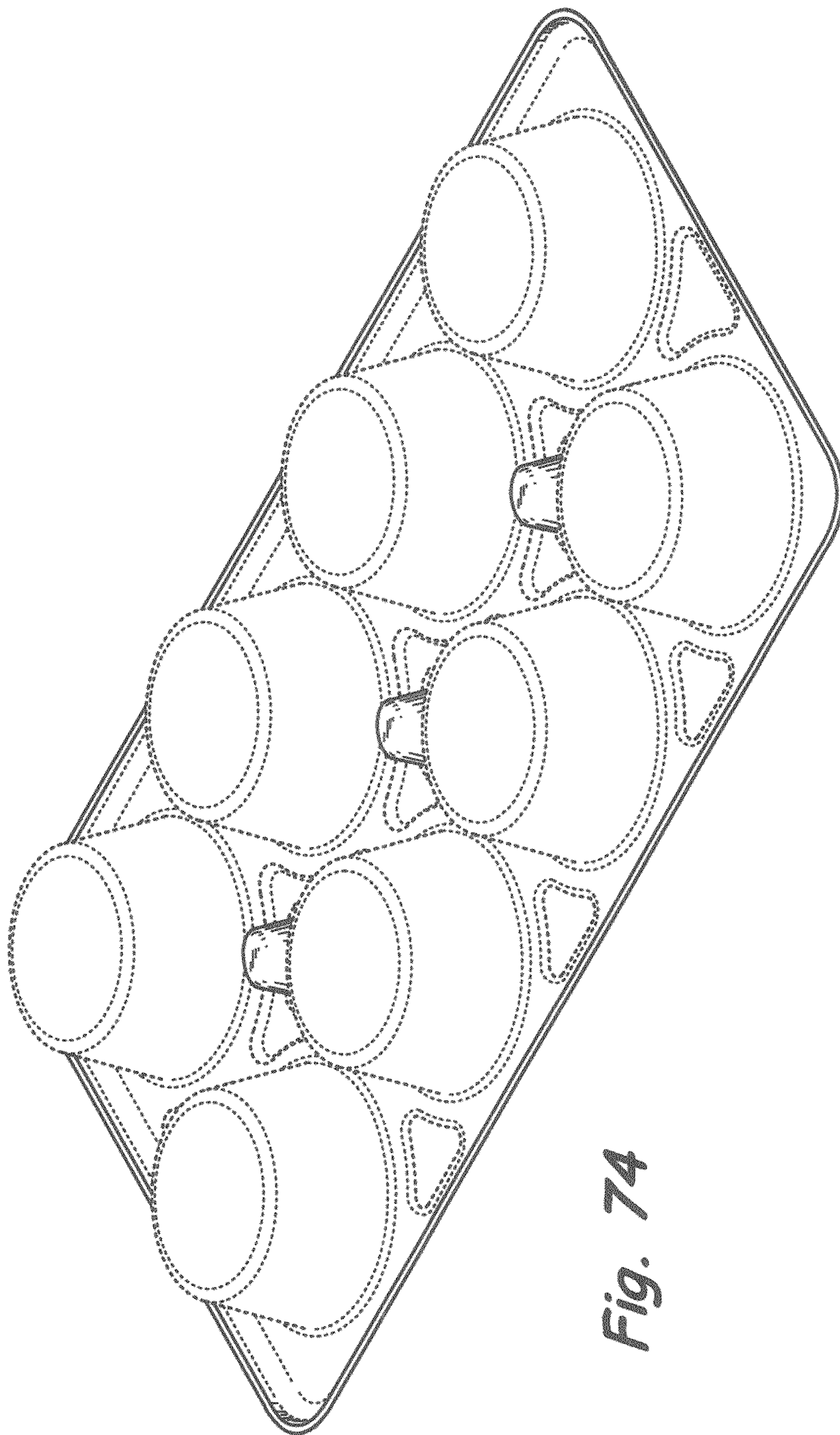

Fig. 74

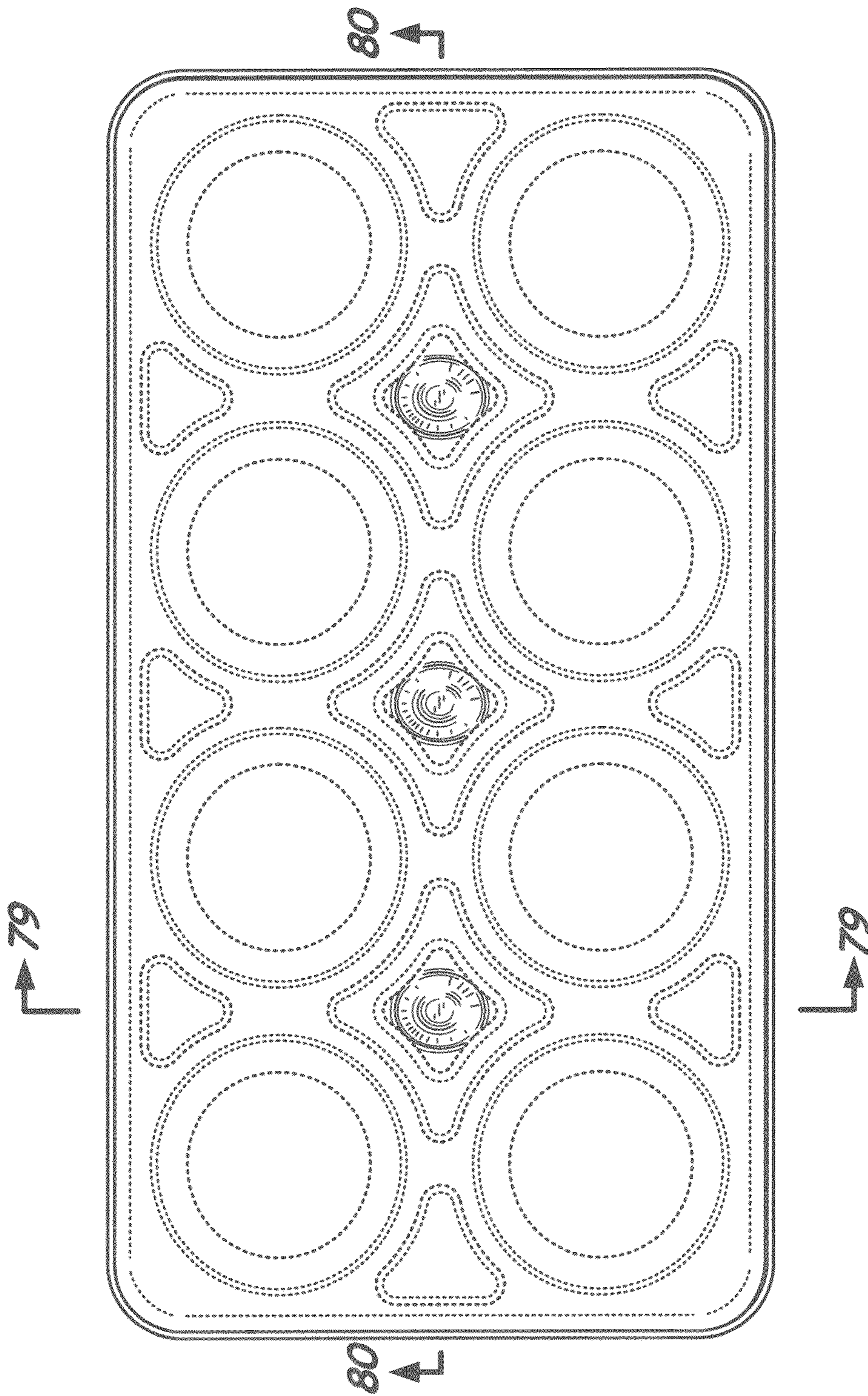

Fig. 75

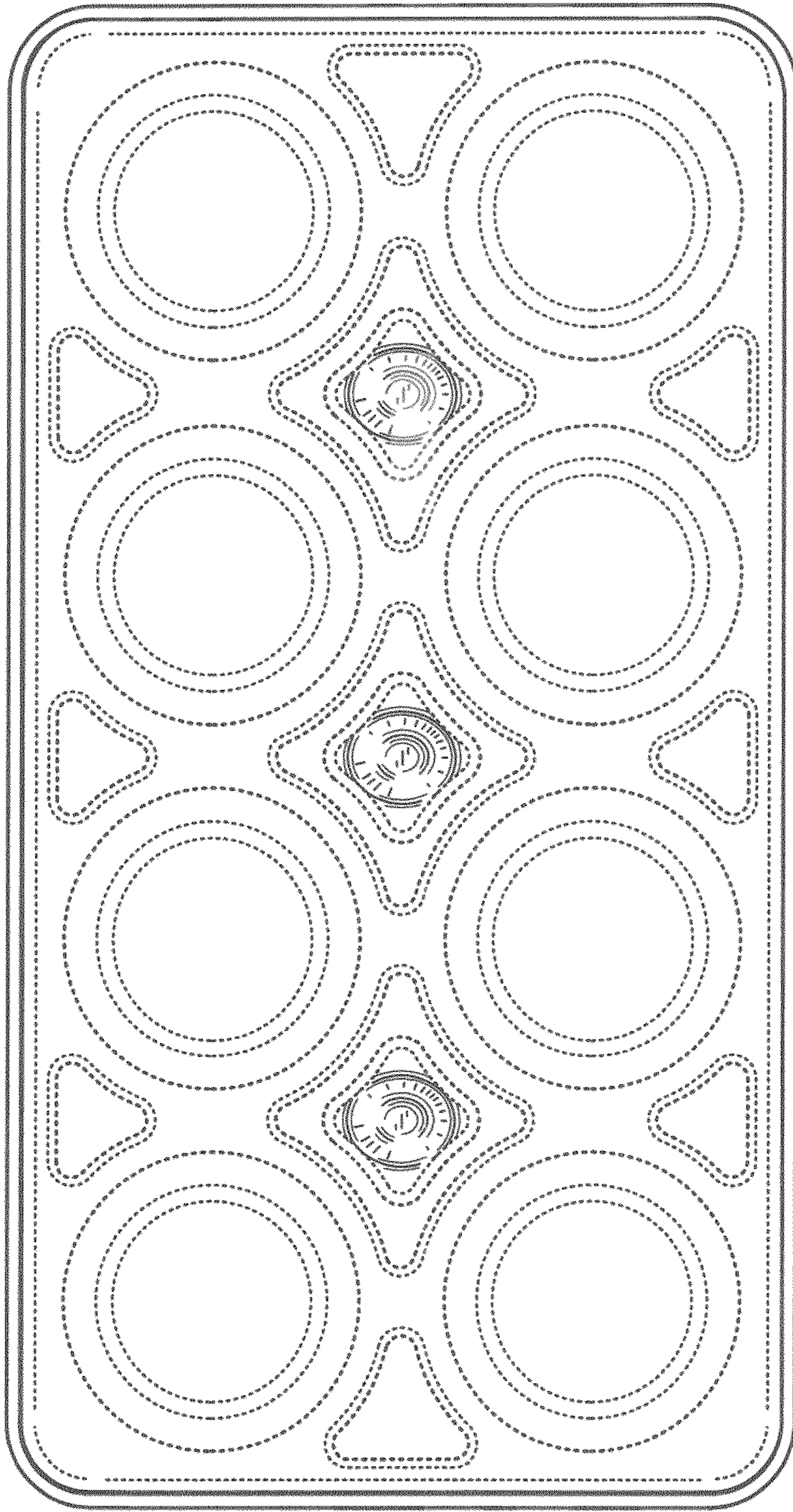

Fig. 76

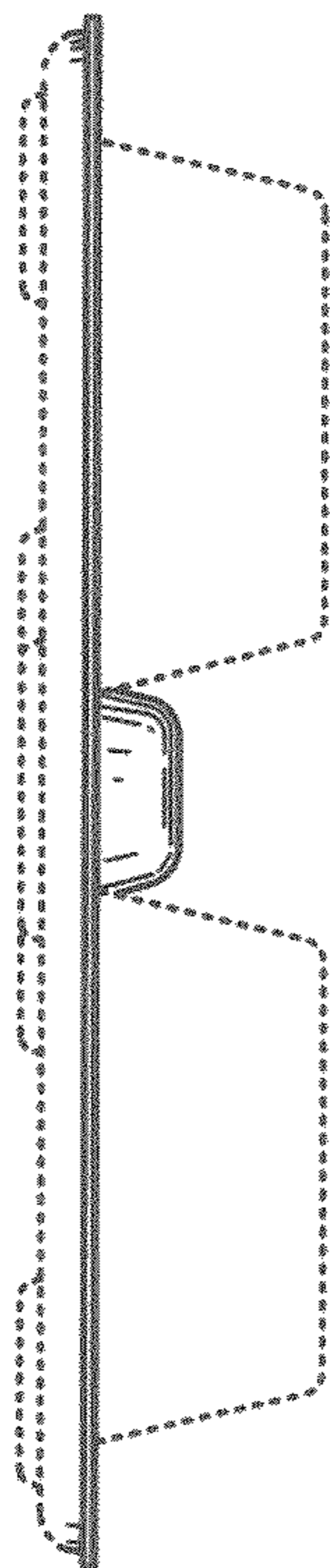

Fig. 77

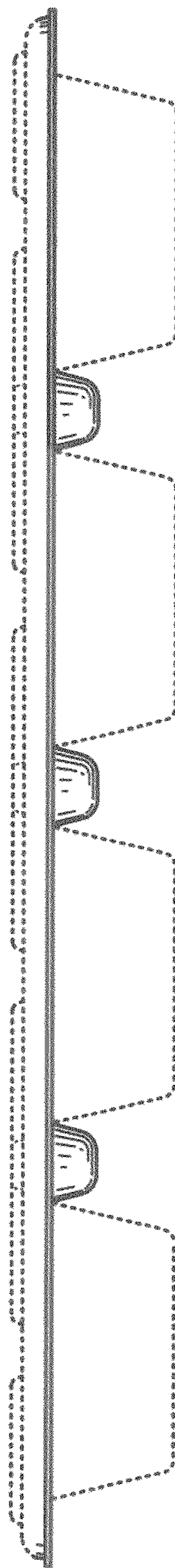

Fig. 78

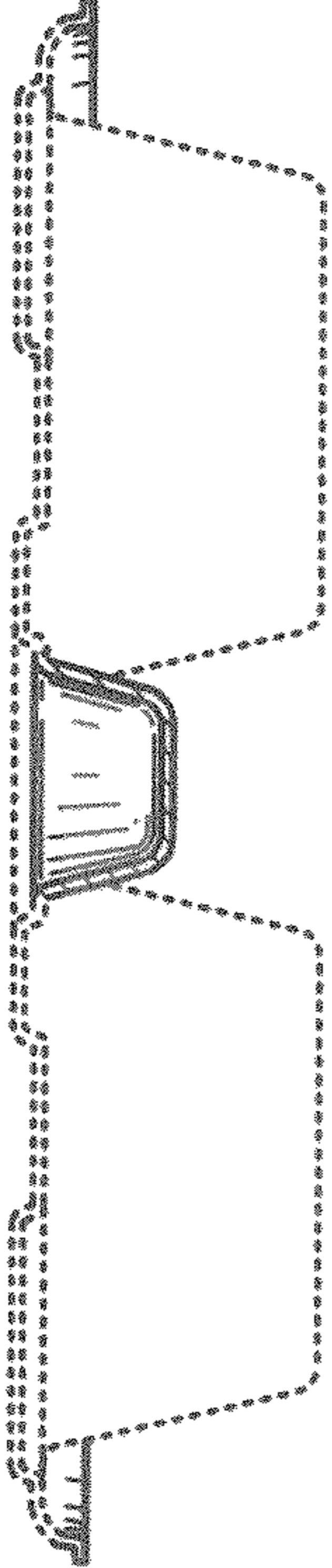

Fig. 79

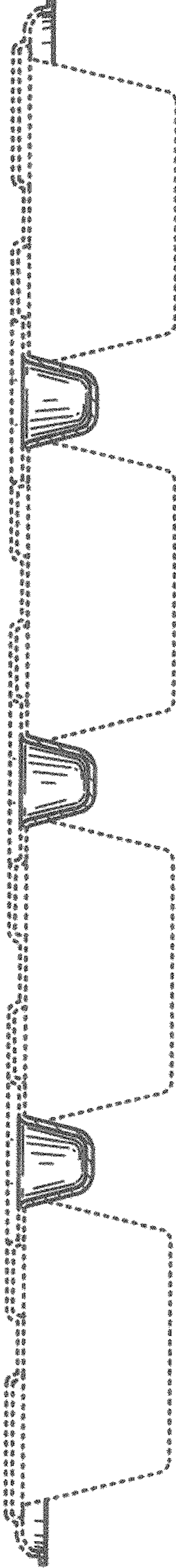

Fig. 80