



US00D739230S

(12) **United States Design Patent**
Kervazo et al.

(10) **Patent No.:** **US D739,230 S**

(45) **Date of Patent:** **** Sep. 22, 2015**

(54) **PACKAGING POT**

(71) Applicant: **ERCA**, ZI de Courtaboeuf (FR)

(72) Inventors: **Michel Kervazo**, St Gervais (FR); **Tim Cooper**, L'Hay les Rose (FR)

(73) Assignee: **ERCA**, Les Ulis (FR)

(**) Term: **14 Years**

(21) Appl. No.: **29/498,405**

(22) Filed: **Aug. 4, 2014**

(30) **Foreign Application Priority Data**

Feb. 4, 2014 (EM) 002397851-0004

(51) **LOC (10) Cl.** **09-03**

(52) **U.S. Cl.**
USPC **D9/425**

(58) **Field of Classification Search**
USPC D9/414, 415, 416, 419, 420, 421, 422,
D9/423, 424, 425, 426, 427, 428, 429, 432,
D9/454, 457, 652, 667, 721, 904;
D7/619.1; 229/400, 401, 403, 404,
229/405, 406, 407, 779; 220/592.16,
220/656-659, 662, 665, 669-675,
220/4.21-4.27; 206/214, 217, 431, 503,
206/514, 521.1, 528, 530, 557, 564, 775,
206/776, 779

CPC A47J 36/06; A47J 47/14; B65D 1/22;
B65D 1/34; B65D 1/40; B65D 1/165; B65D
15/02; B65D 21/083; B65D 21/0233; B65D
21/0234; B65D 43/162; B65D 71/50; B65D
77/24; B65D 77/245; B65D 81/3869; B65D
2543/00046; B65D 2543/00083; B65D
2543/00092; B65D 2543/00296; B65D 3/06;
B65D 3/28; B65D 5/4204; B65D 7/46;
B65D 85/34; B21D 51/18; B21D 51/2646

See application file for complete search history.

(56) **References Cited**

U.S. PATENT DOCUMENTS

D34,569	S	*	5/1901	Tatum	D9/424
D271,555	S	*	11/1983	Daenen et al.	D7/603
D369,971	S	*	5/1996	Brauner et al.	D9/428
5,782,376	A	*	7/1998	Brauner et al.	220/669
D502,060	S	*	2/2005	Dias et al.	D7/629
D512,631	S	*	12/2005	Lhoste et al.	D9/558
D630,504	S	*	1/2011	Scott et al.	D9/425
D653,913	S	*	2/2012	Stamper et al.	D7/602
D690,198	S	*	9/2013	Haracourt et al.	D9/432
D700,838	S	*	3/2014	Oommen	D9/425
2003/0108714	A1	*	6/2003	Razeti	428/138
2012/0251679	A1	*	10/2012	Ferry	426/130
2015/0096981	A1	*	4/2015	Yu	220/23.83

* cited by examiner

Primary Examiner — Karen S Acker

Assistant Examiner — Wendy Arminio

(74) *Attorney, Agent, or Firm* — Ladas & Parry LLP

(57) **CLAIM**

The ornamental design for a packaging pot, as shown.

DESCRIPTION

FIG. 1 is a top/front/left side perspective view of a packaging pot showing our new design;

FIG. 2 is a bottom/side perspective view thereof, shown in an upside down position;

FIG. 3 is a top/front/side perspective view thereof;

FIG. 4 is a bottom/front/side perspective view thereof, shown in a sideways position;

FIG. 5 is a rear/bottom/side perspective view thereof, shown in a sideways position;

FIG. 6 is a side elevational view thereof; and,

FIG. 7 is a top plan view thereof.

1 Claim, 7 Drawing Sheets

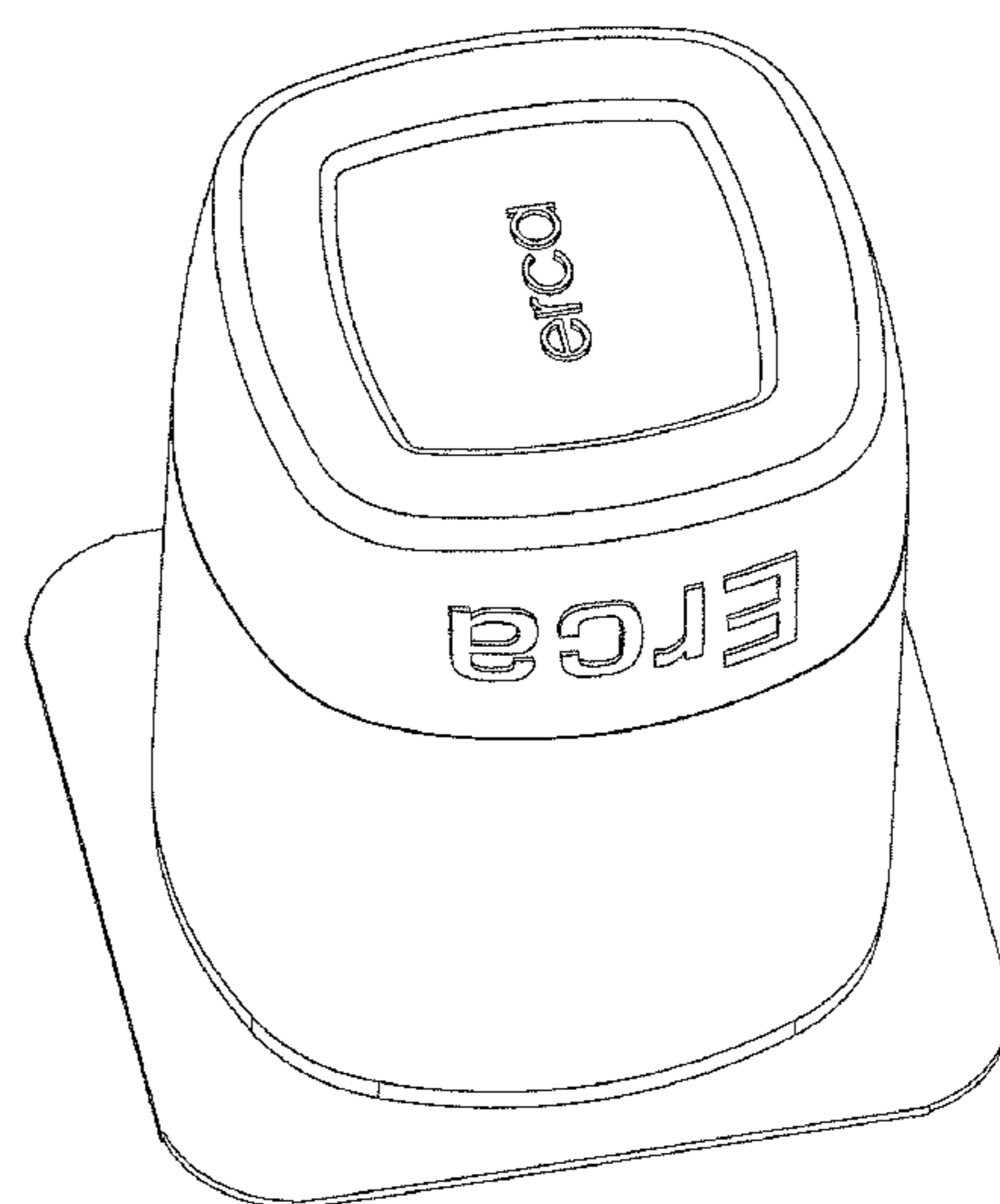
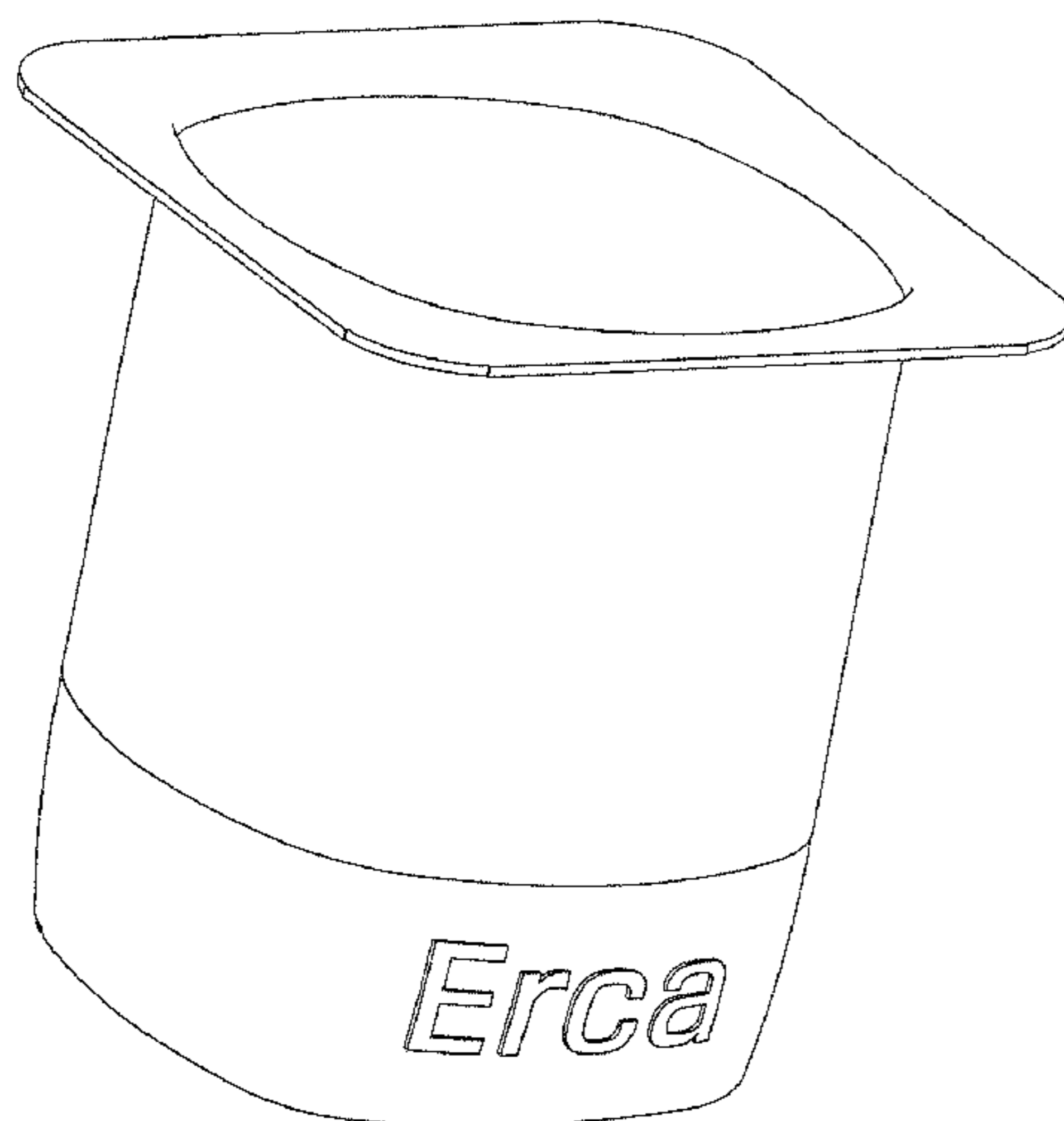

FIG. 1

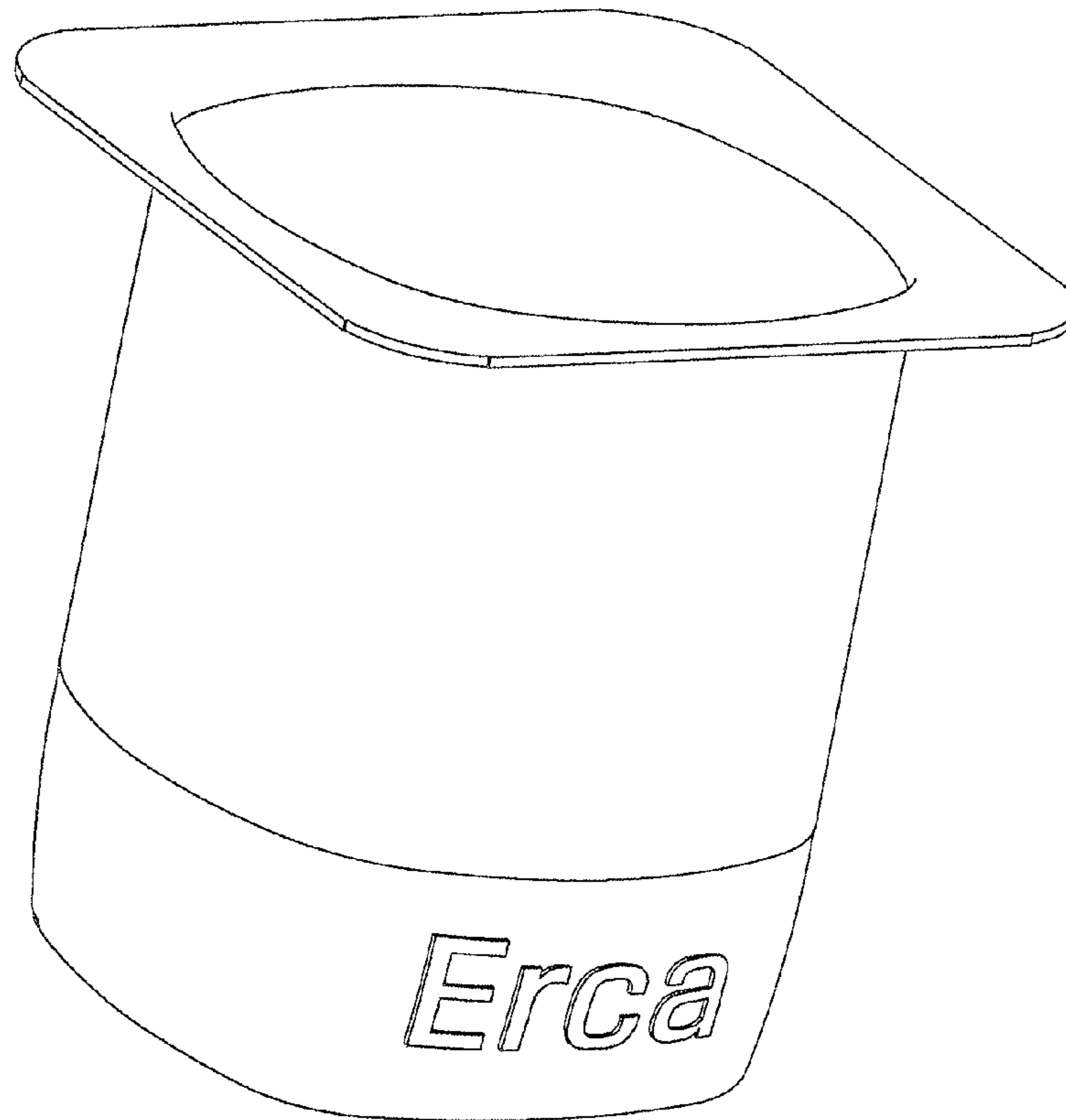

FIG. 2

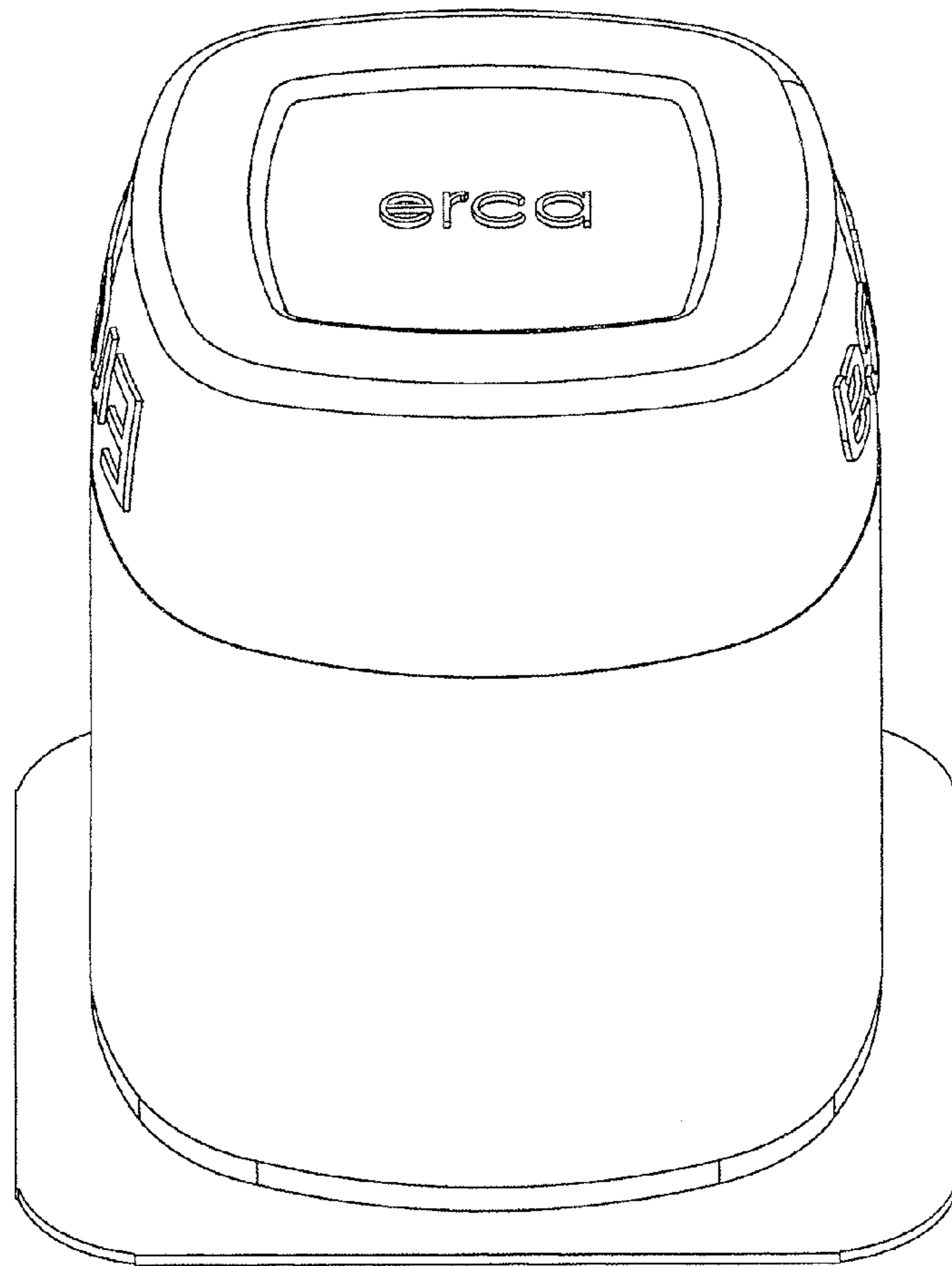

FIG. 3

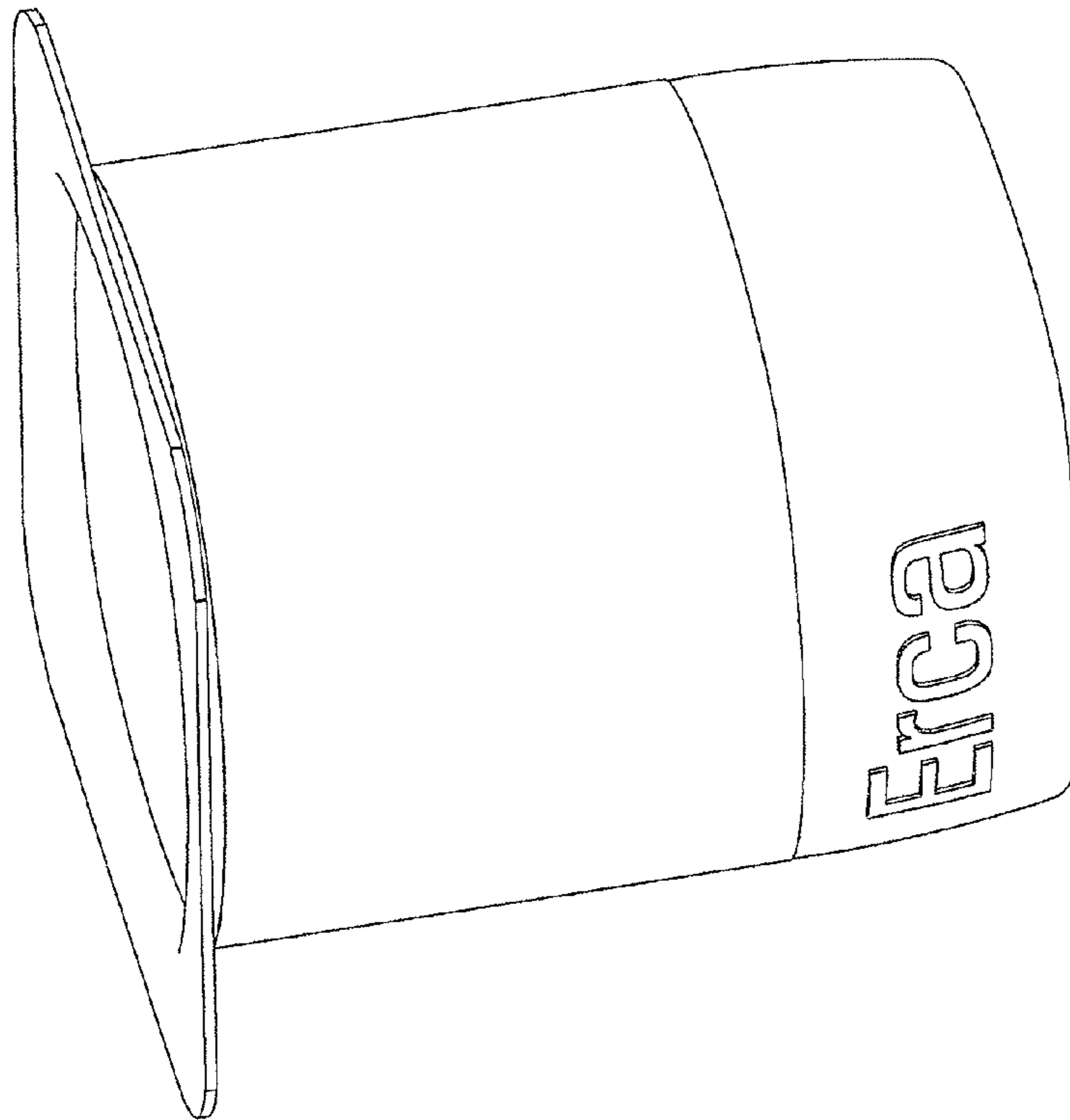

FIG. 4

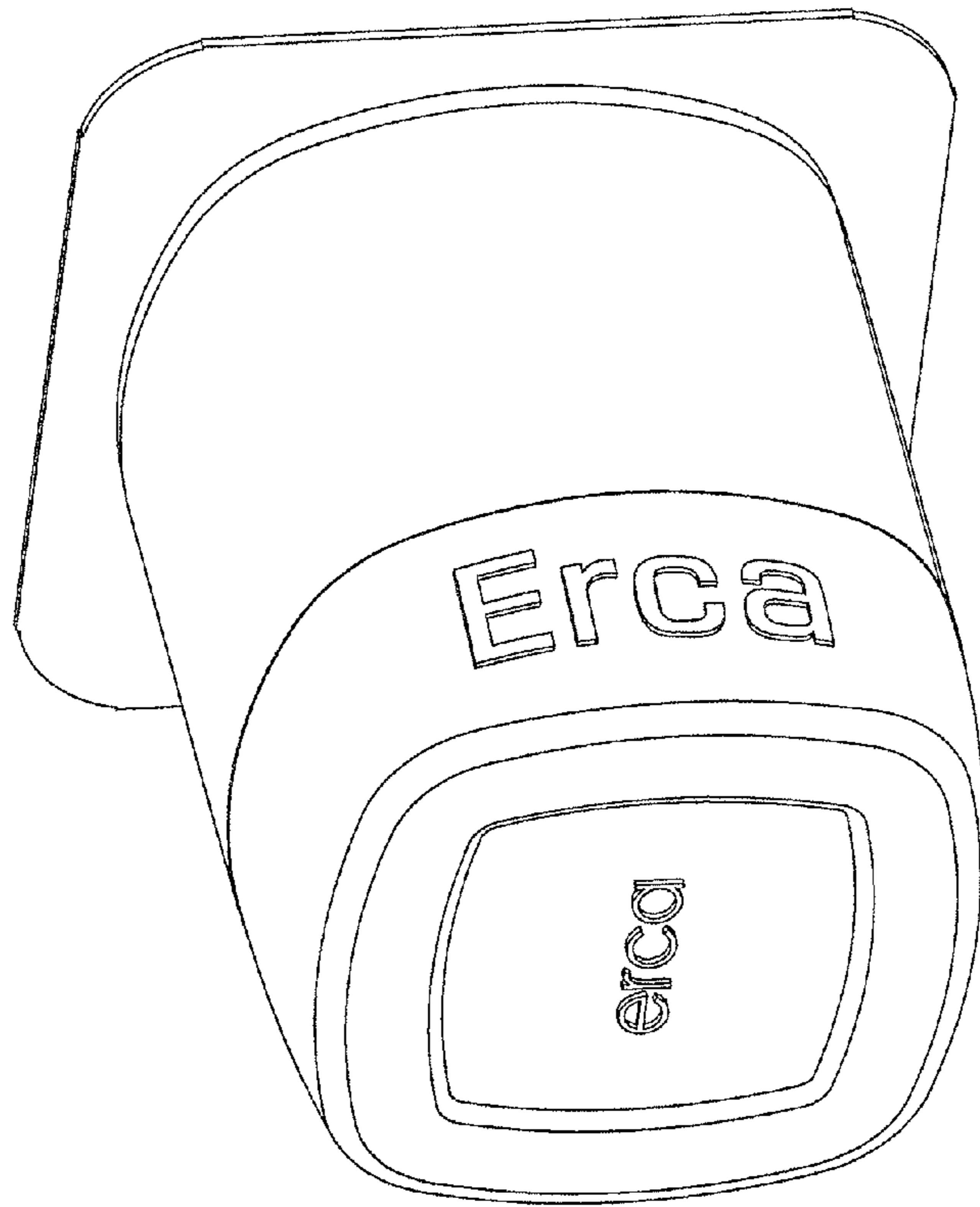

FIG. 5

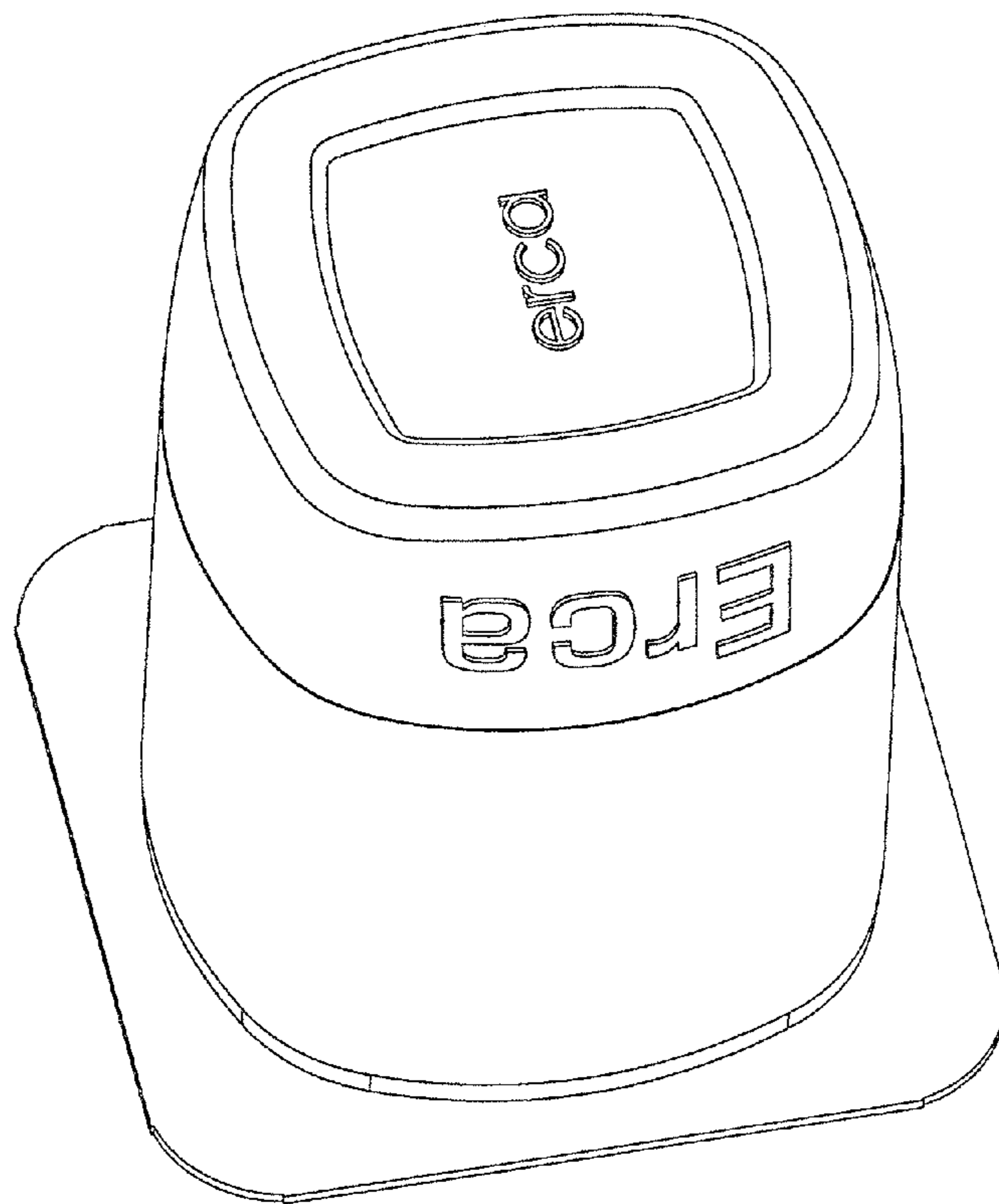

FIG. 6

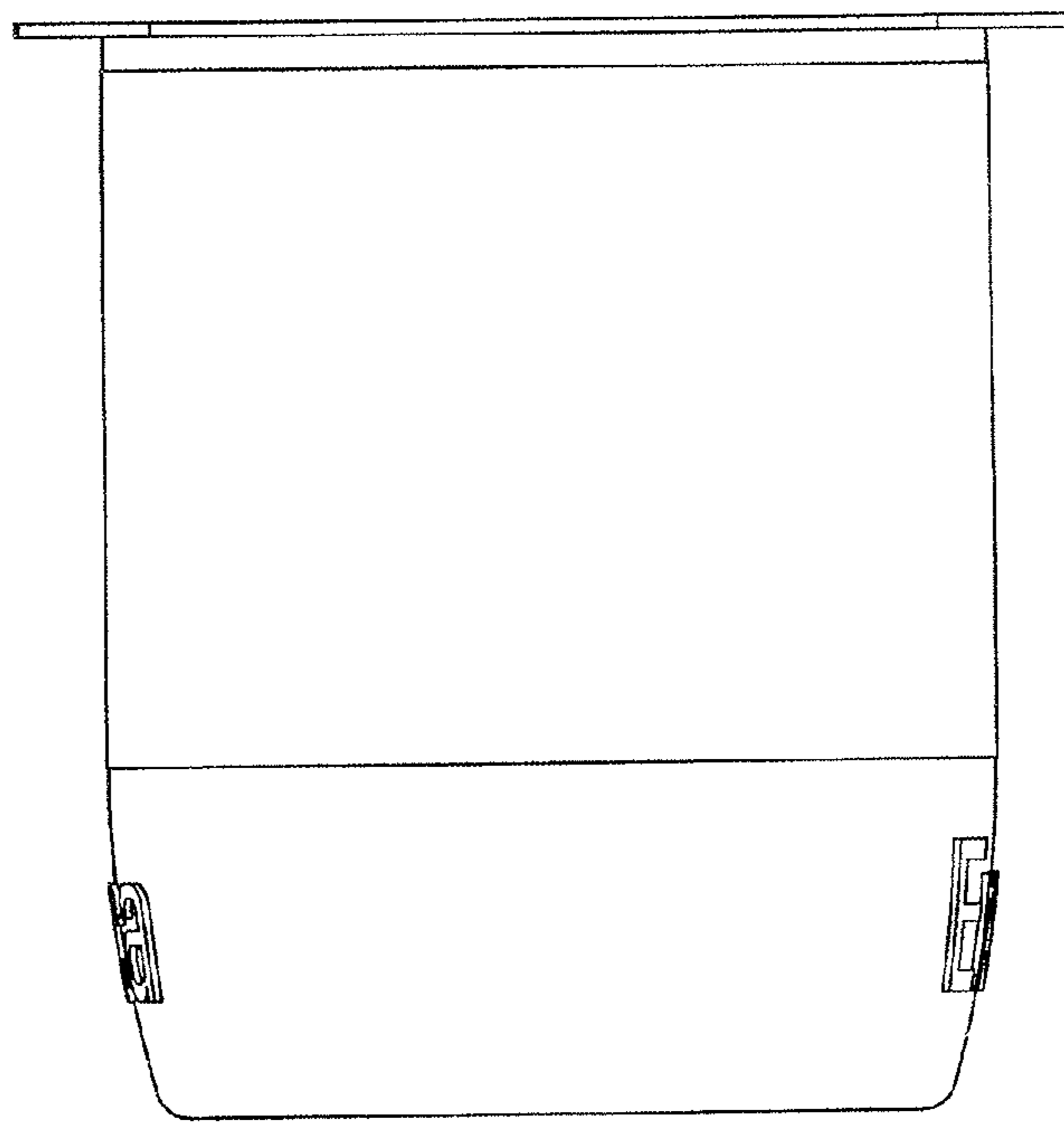

FIG. 7

