



US00D739156S

(12) **United States Design Patent**  
**Webb**

(10) **Patent No.:** **US D739,156 S**

(45) **Date of Patent:** **\*\* Sep. 22, 2015**

(54) **FURNITURE MODULE**

D605,868 S \* 12/2009 Holbrook ..... D6/378  
D646,499 S \* 10/2011 Metcalf et al. .... D6/378  
D669,702 S \* 10/2012 Barefoot ..... D6/378

(71) Applicant: **Roger Webb Associates Ltd**, London  
(GB)

\* cited by examiner

(72) Inventor: **Roger Webb**, London (GB)

*Primary Examiner* — Mimoso De

(73) Assignee: **Roger Webb Associates Ltd**, London  
(GB)

(74) *Attorney, Agent, or Firm* — Abelman, Frayne &  
Schwab

(\*\*) Term: **14 Years**

(57) **CLAIM**

What is claimed the ornamental design for furniture modules,  
as shown and described.

(21) Appl. No.: **29/475,306**

**DESCRIPTION**

(22) Filed: **Dec. 2, 2013**

(51) **LOC (10) Cl.** ..... **06-01**

(52) **U.S. Cl.**  
USPC ..... **D6/378**

(58) **Field of Classification Search**  
USPC ..... D6/334–336, 364, 371, 373, 374, 378,  
D6/381, 716, 716.1, 716.4  
CPC ..... A47C 1/00; A47C 7/18; A47C 7/24;  
A47C 7/021; A47C 5/06; A47C 15/002;  
B60N 2/70  
See application file for complete search history.

FIG. 1 is a front elevation view of the furniture modules  
showing my new design,  
FIG. 2 is a left side elevation thereof; the right side elevation  
view is a mirror image of the left side elevation view,  
FIG. 3 is a rear elevation view thereof,  
FIG. 4 is a top plan view thereof, the bottom plan view is not  
shown and is not claimed in this and in all the figures in this  
application,  
FIG. 5 is a top rear and right side perspective view thereof;  
and,  
FIG. 6 is a top front left side elevation view thereof.  
In all the above figures the bottom view is not shown and is not  
claimed, and the small feet elements at the bottom in each of  
the figures are deemed to be background and are not claimed  
and are shown in dashed line where possible.

(56) **References Cited**

**U.S. PATENT DOCUMENTS**

D240,481 S \* 7/1976 Fister, Jr. .... D6/378  
D262,166 S \* 12/1981 Aronowitz et al. .... D6/378  
7,523,989 B2 \* 4/2009 Wieland et al. .... A47C 15/002

**1 Claim, 1 Drawing Sheet**

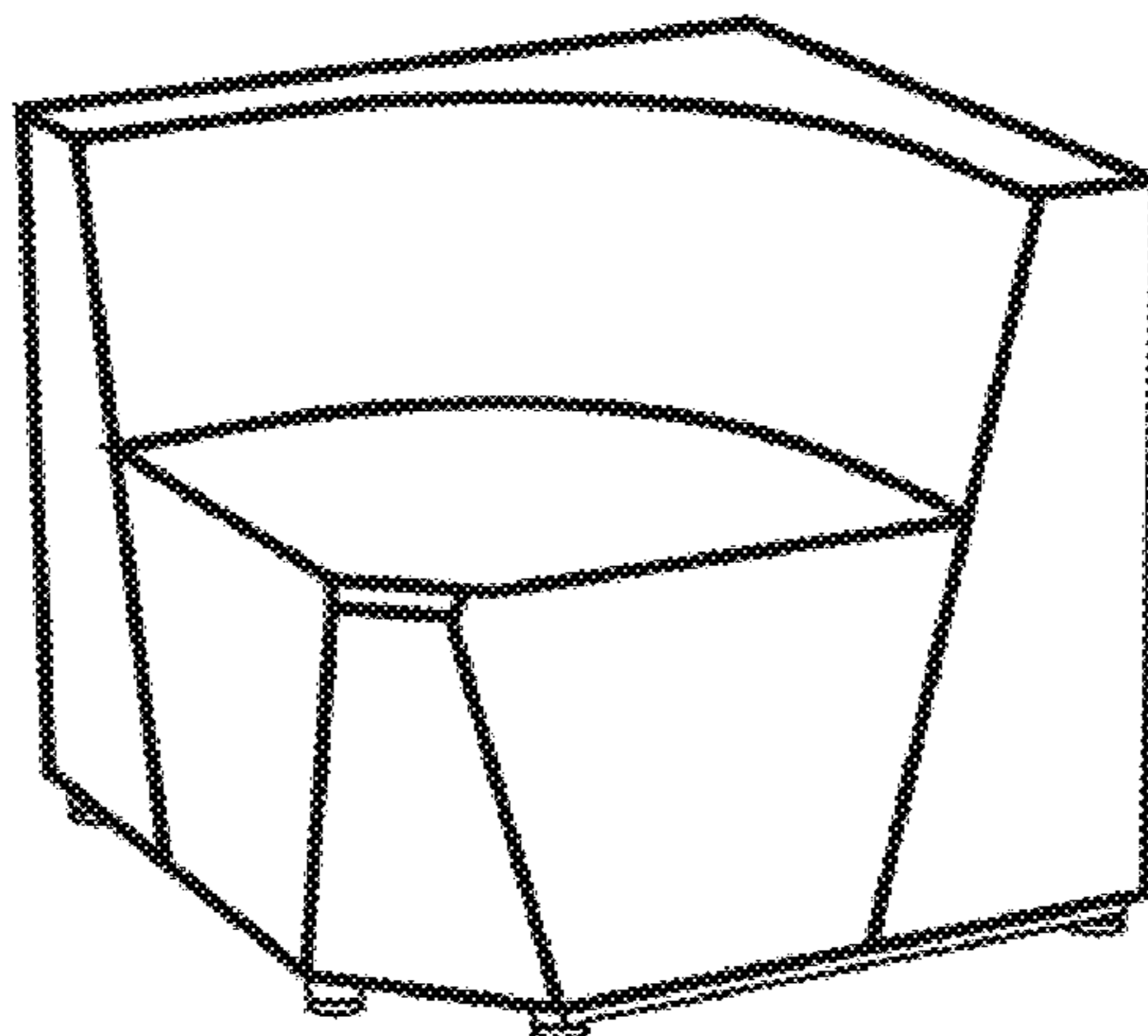

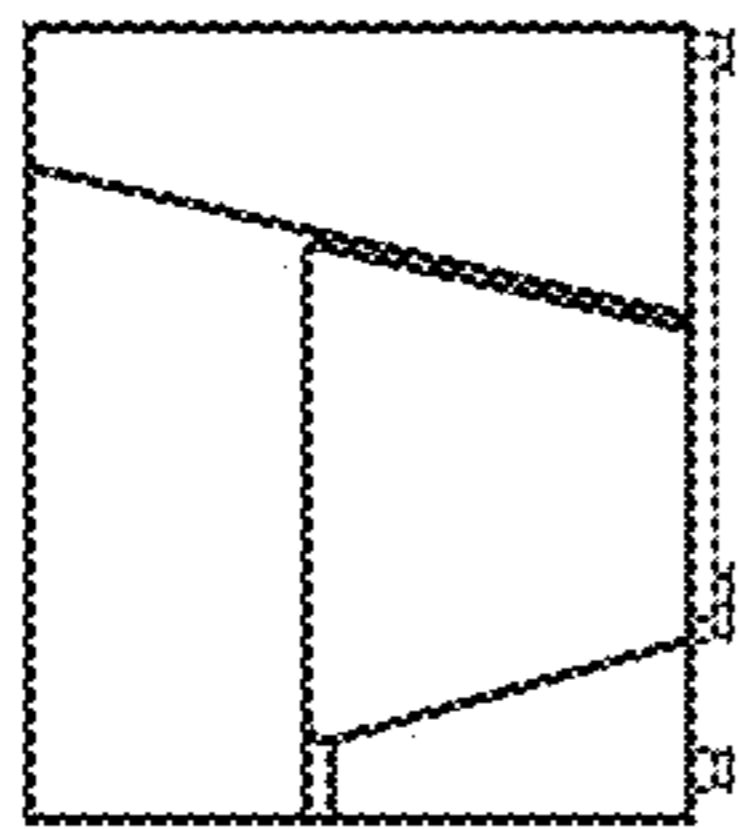

FIG. 1

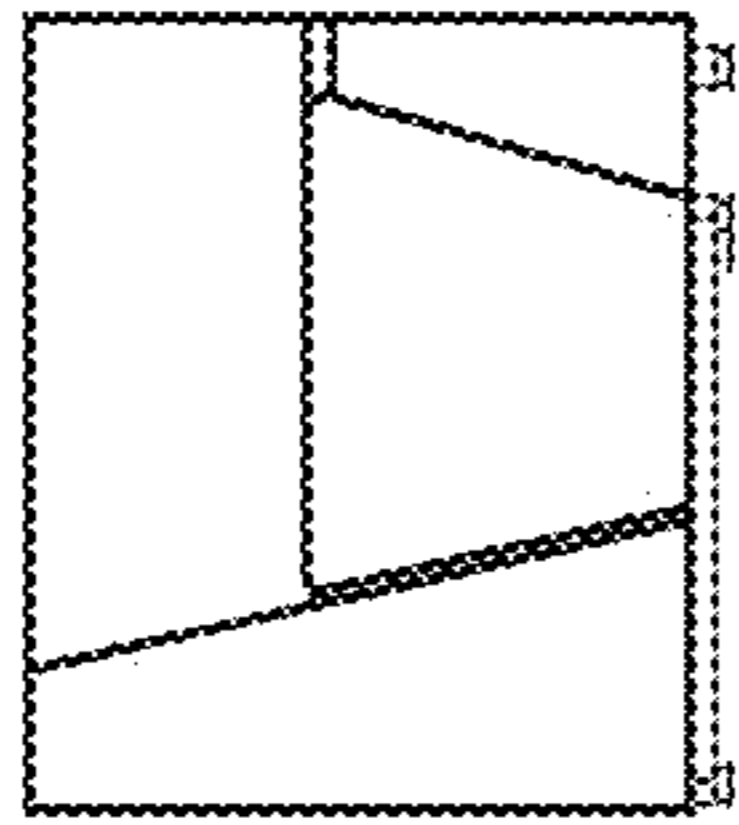

FIG. 2

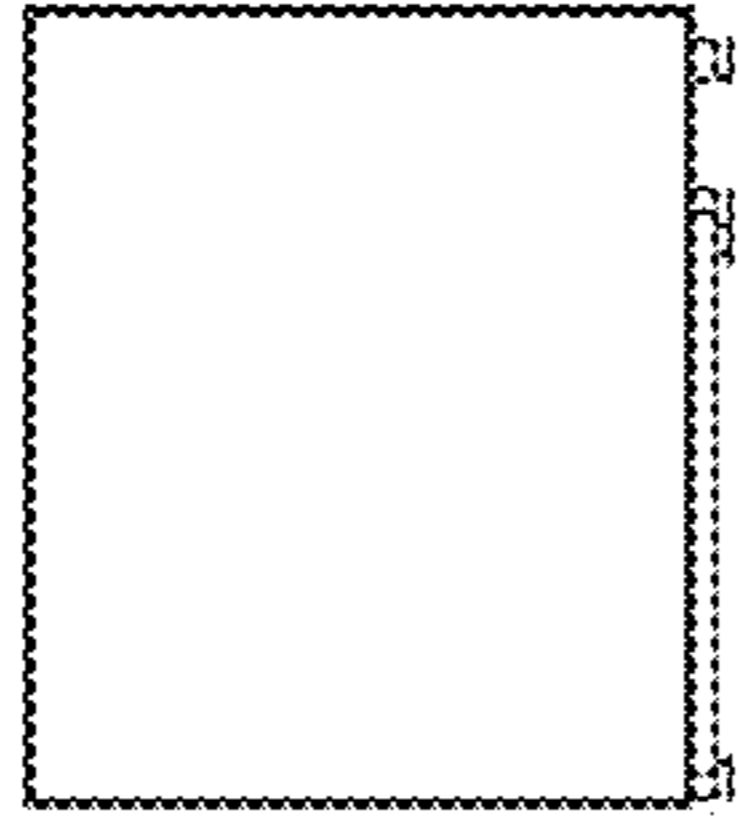

FIG. 3

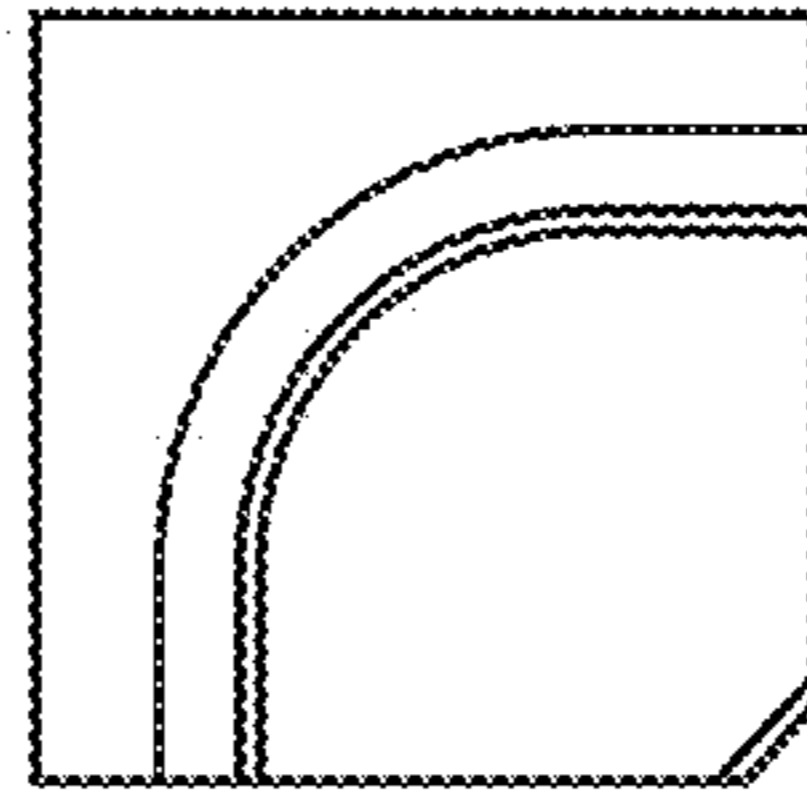

FIG. 4

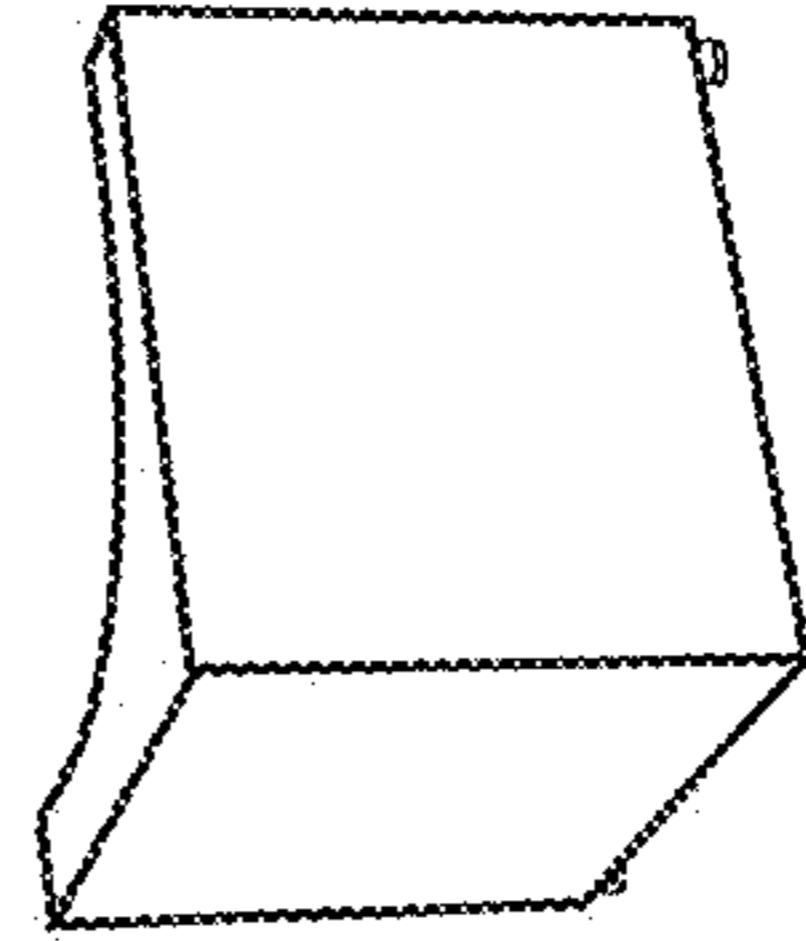

FIG. 5

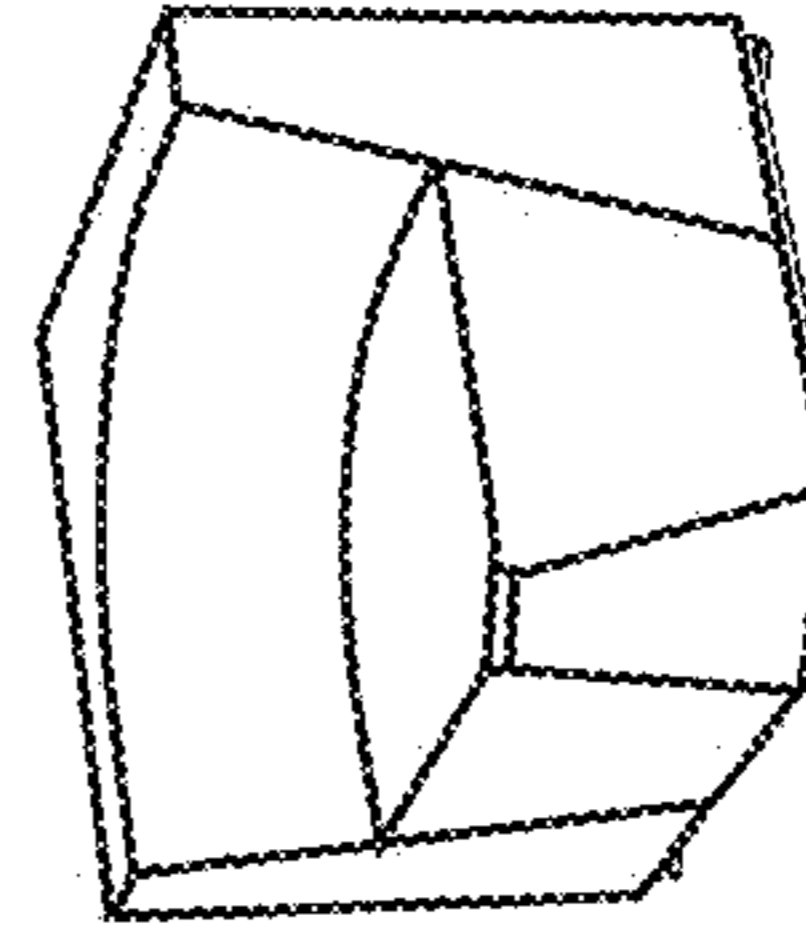

FIG. 6