



US00D739139S

(12) **United States Design Patent**  
**Kinskey**

(10) **Patent No.:** **US D739,139 S**

(45) **Date of Patent:** **\*\* Sep. 22, 2015**

(54) **CLIP ON, TAPERED-ARM AIR GUN  
HOLSTER**

(56) **References Cited**

U.S. PATENT DOCUMENTS

(71) Applicant: **LF Centennial Ltd.**, Road Town, Tortola  
(VG)

3,157,927	A *	11/1964	Roden .....	24/3.7
D240,370	S *	7/1976	Kuehl .....	D3/228
4,457,462	A *	7/1984	Taormina .....	224/269
5,511,705	A *	4/1996	Dreszer .....	224/666
D373,243	S *	9/1996	Tovey et al. ....	D3/228
D374,604	S *	10/1996	Hnatowicz et al. ....	D8/373
5,944,242	A *	8/1999	Musarella et al. ....	224/667
D448,556	S *	10/2001	Snider .....	D3/228
D488,924	S *	4/2004	Miller .....	D3/228
8,056,715	B2 *	11/2011	Conklin .....	206/338
8,308,034	B2 *	11/2012	Shibata et al. ....	224/269

(72) Inventor: **Terrence P. Kinskey**, Alpharetta, GA  
(US)

(73) Assignee: **LF Centennial Ltd.**, Road Town, Tortola  
(VG)

(\*\*) Term: **14 Years**

\* cited by examiner

(21) Appl. No.: **29/495,146**

*Primary Examiner* — Catheri Oliver-Garcia

(22) Filed: **Jun. 27, 2014**

(74) *Attorney, Agent, or Firm* — Duane Morris LLP; J. Rodman Steele, Jr.; Gregory M. Lefkowitz

**Related U.S. Application Data**

(63) Continuation-in-part of application No. 29/482,775,  
filed on Feb. 21, 2014, now Pat. No. Des. 723,266, and  
a continuation-in-part of application No. 29/491,534,  
filed on May 22, 2014.

(51) **LOC (10) Cl.** ..... **03-01**

(52) **U.S. Cl.**  
USPC ..... **D3/228**

(58) **Field of Classification Search**  
USPC ..... D3/228, 226, 215; 206/259, 338, 349;  
24/3.7; 224/240, 245, 248, 268–270,  
224/582, 680, 666, 677–678, 682–684,  
224/904; D8/373

See application file for complete search history.

(57) **CLAIM**

The ornamental design for a clip-on tapered-arm air gun  
holster, as shown and described.

**DESCRIPTION**

FIG. 1 is a front, perspective view of my ornamental design;  
FIG. 2 is a front view of the ornamental design of FIG. 1;  
FIG. 3 is a back view of the ornamental design of FIG. 1;  
FIG. 4 is a left side view of the ornamental design of FIG. 1;  
FIG. 5 is a right side view of the ornamental design of FIG. 1;  
FIG. 6 is a top view of the ornamental design of FIG. 1;  
FIG. 7 is a bottom view of the ornamental design of FIG. 1;  
and,  
FIG. 8 is an environmental, perspective view of the ornamen-  
tal design with an air gun attached thereto.  
The break lines are shown in the drawing to indicate that no  
particular length is claimed. The air gun shown in FIG. 8 is for  
illustrative purposes only and forms no part of the claimed  
design.

**1 Claim, 7 Drawing Sheets**

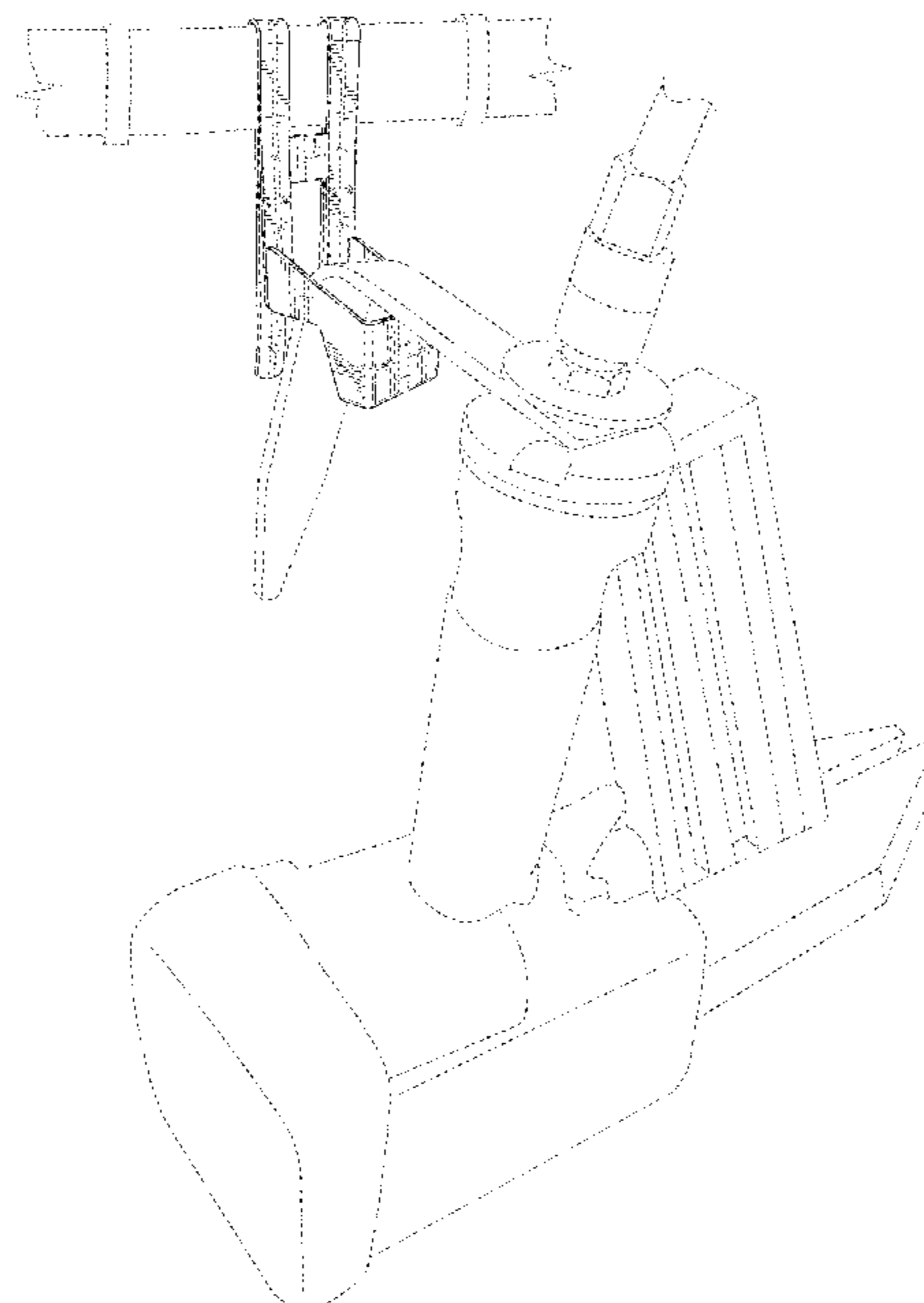

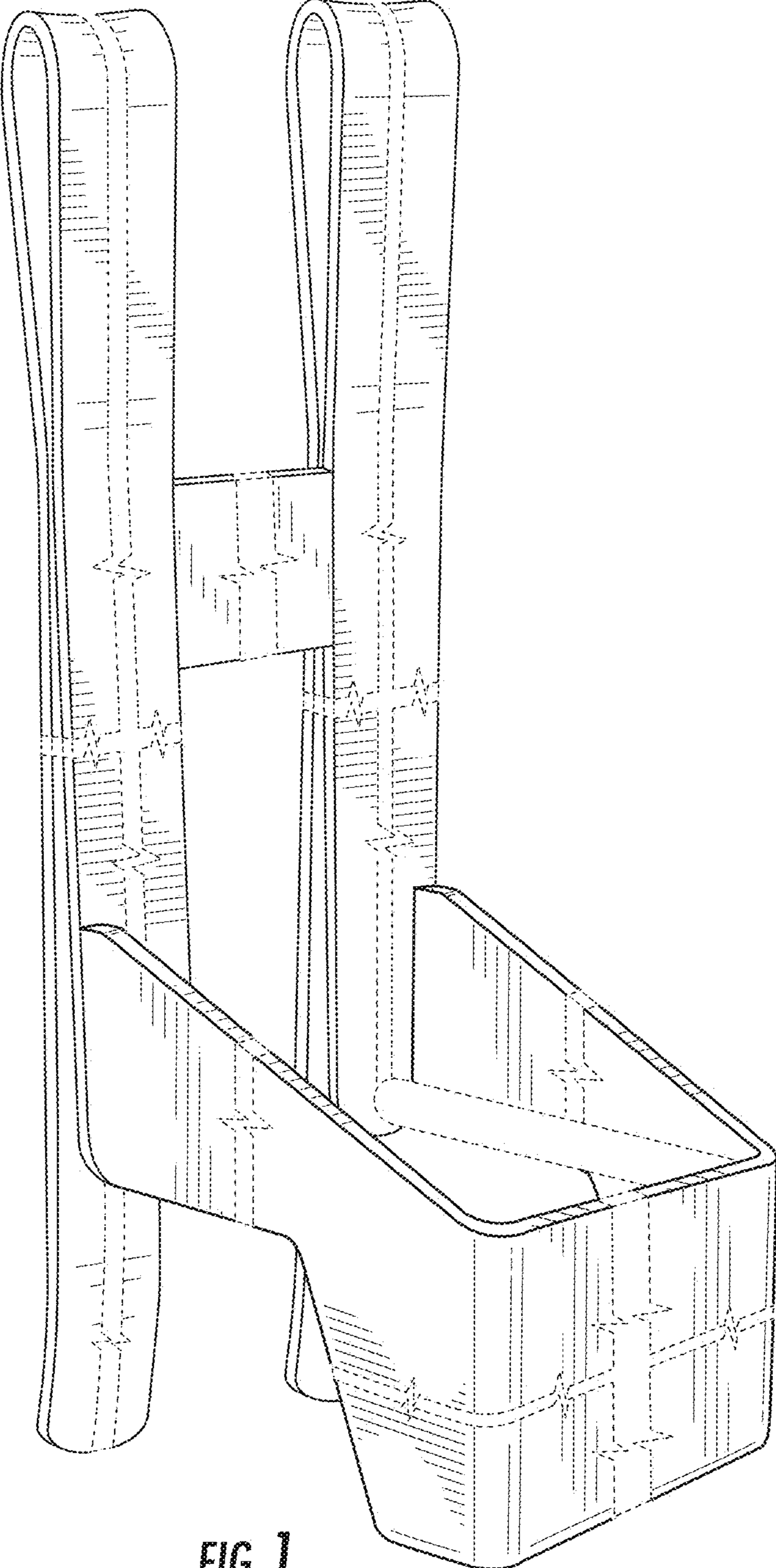

FIG. 1

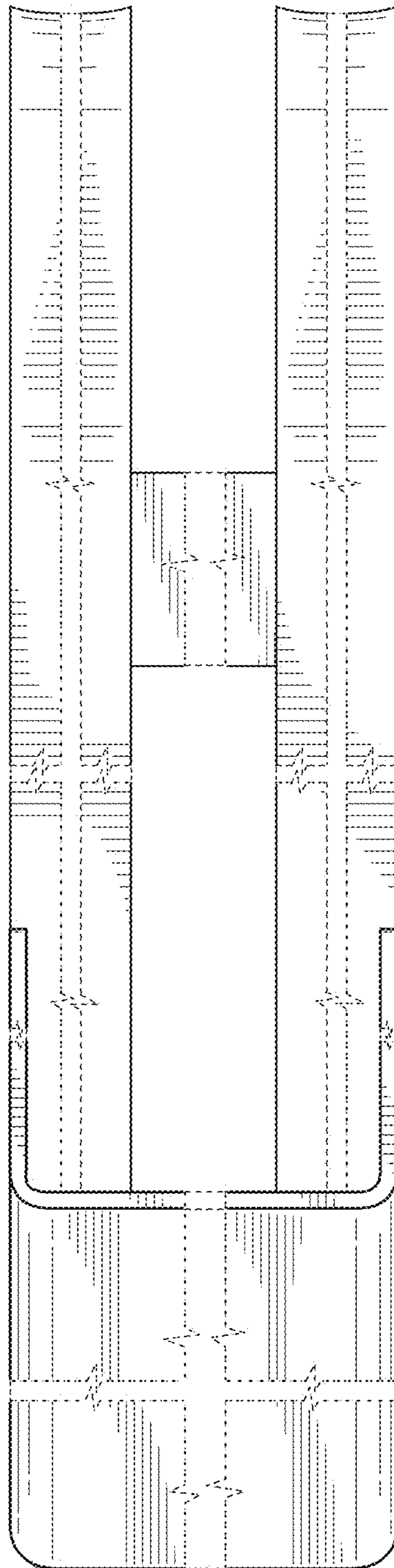

FIG. 2

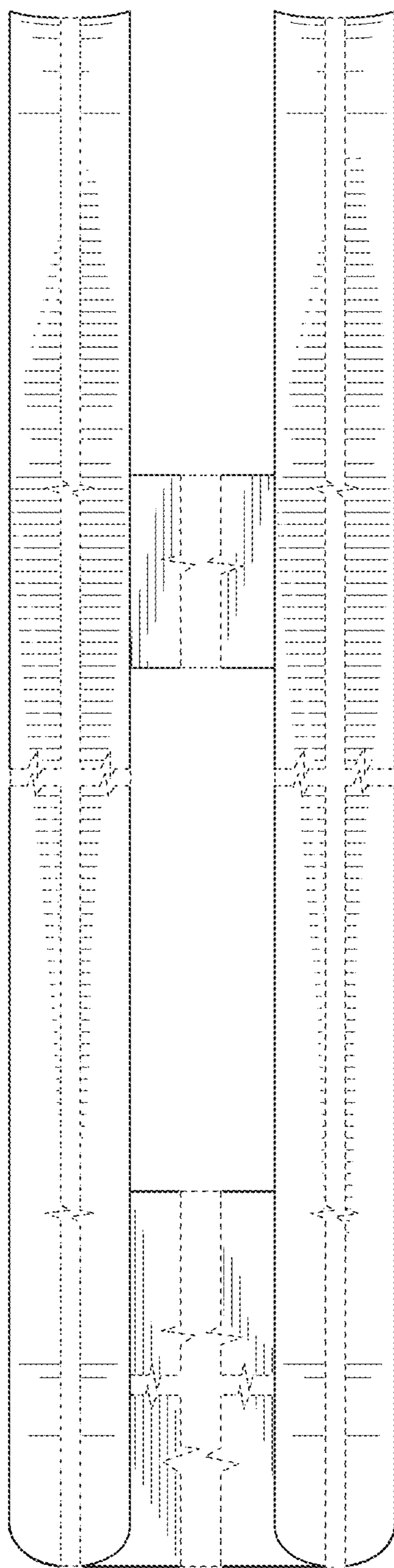

FIG. 3

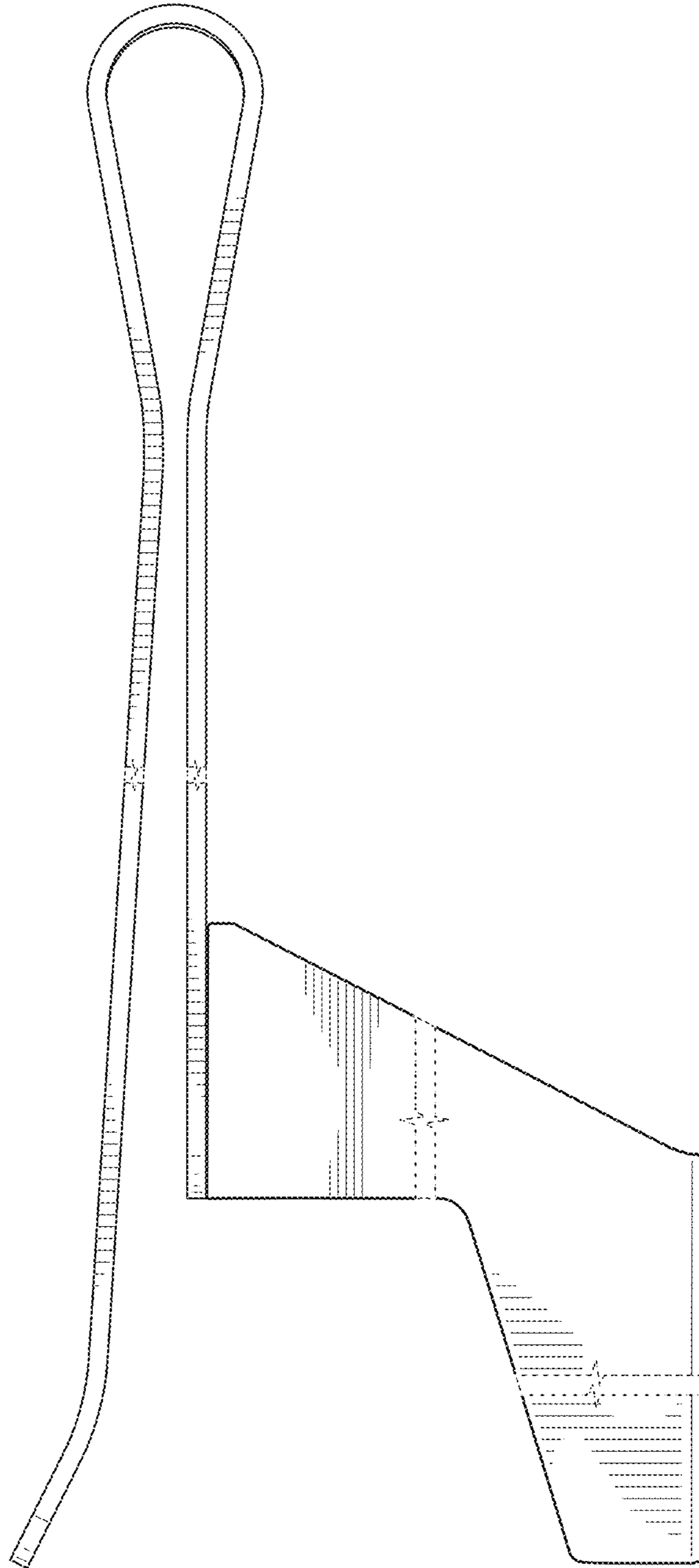

FIG. 4



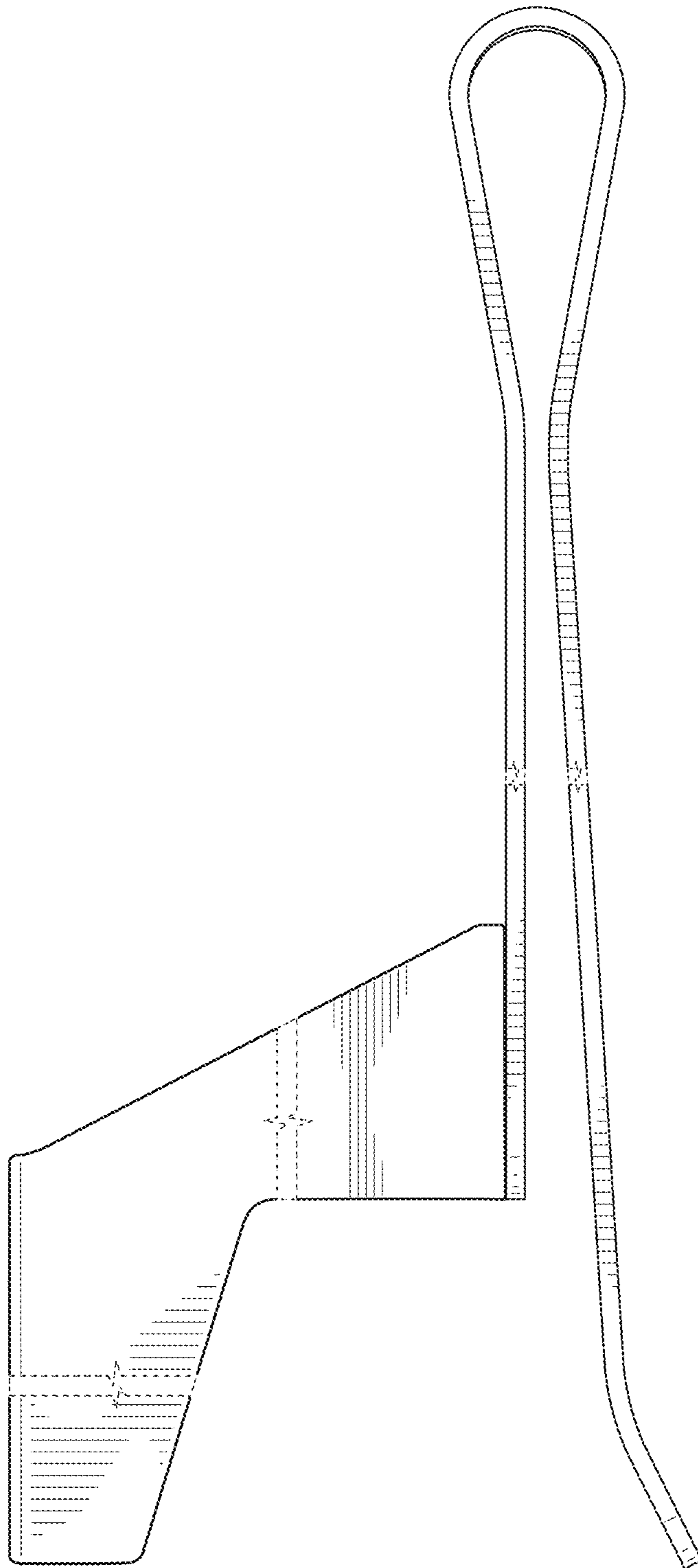

FIG. 5

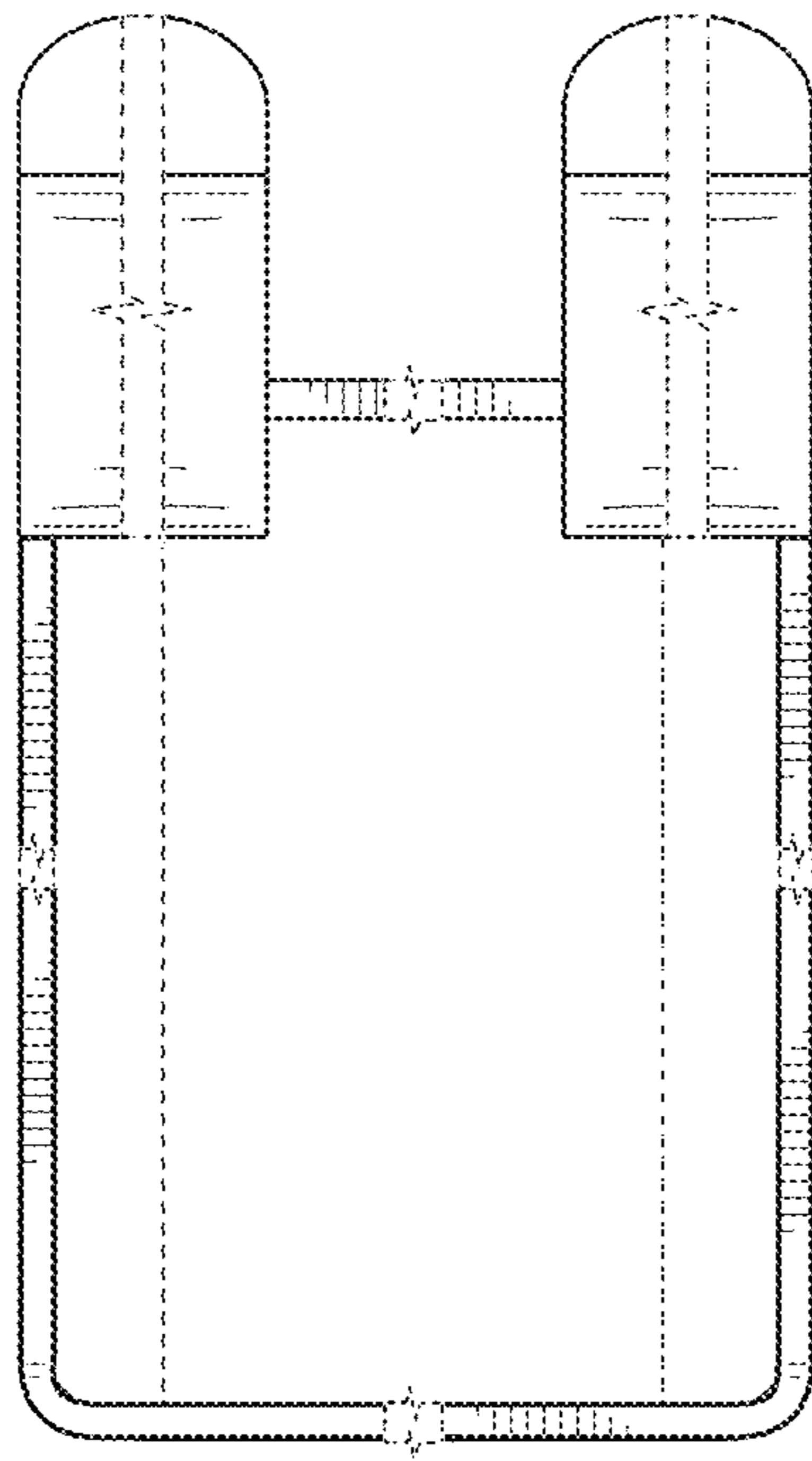

FIG. 6

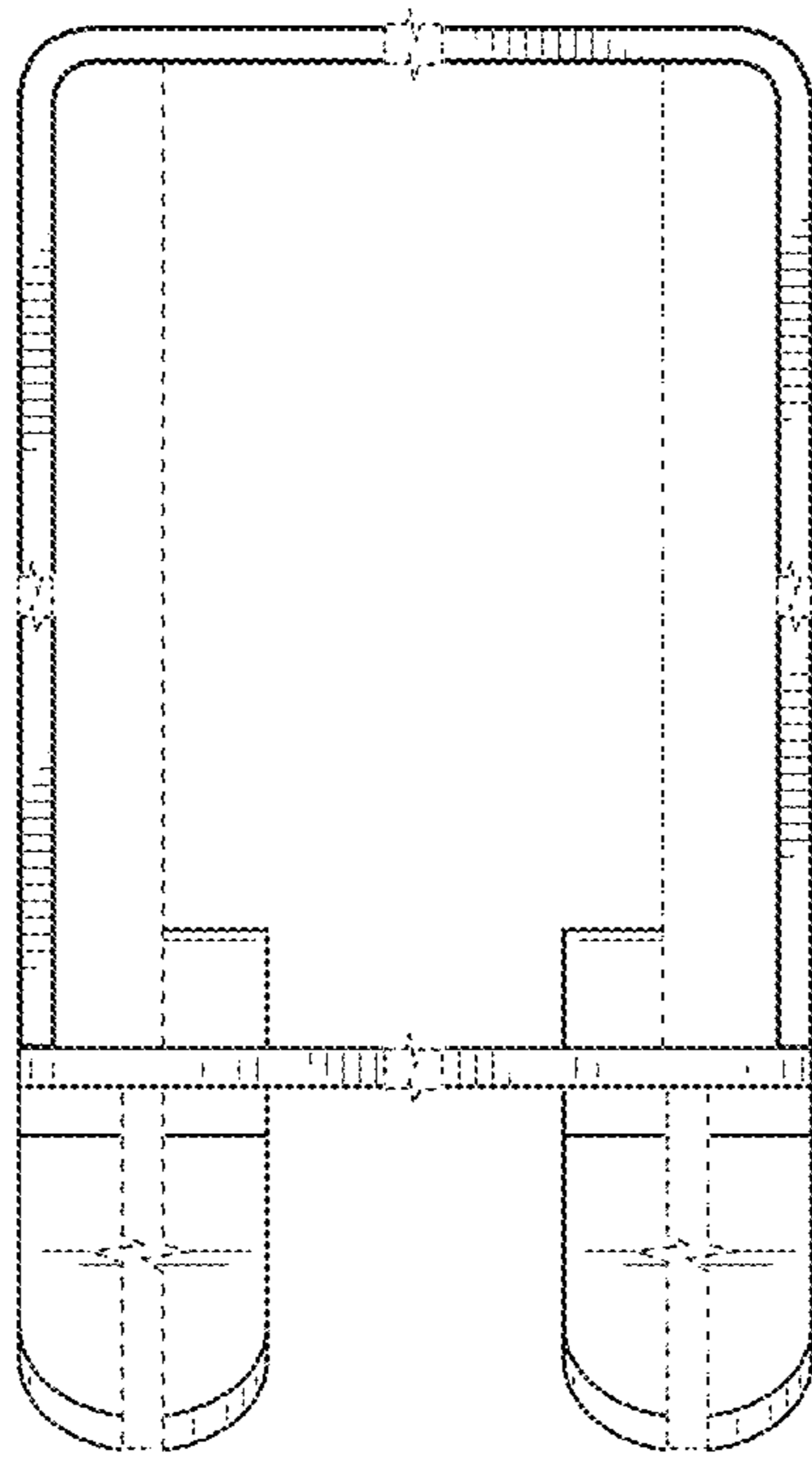

FIG. 7

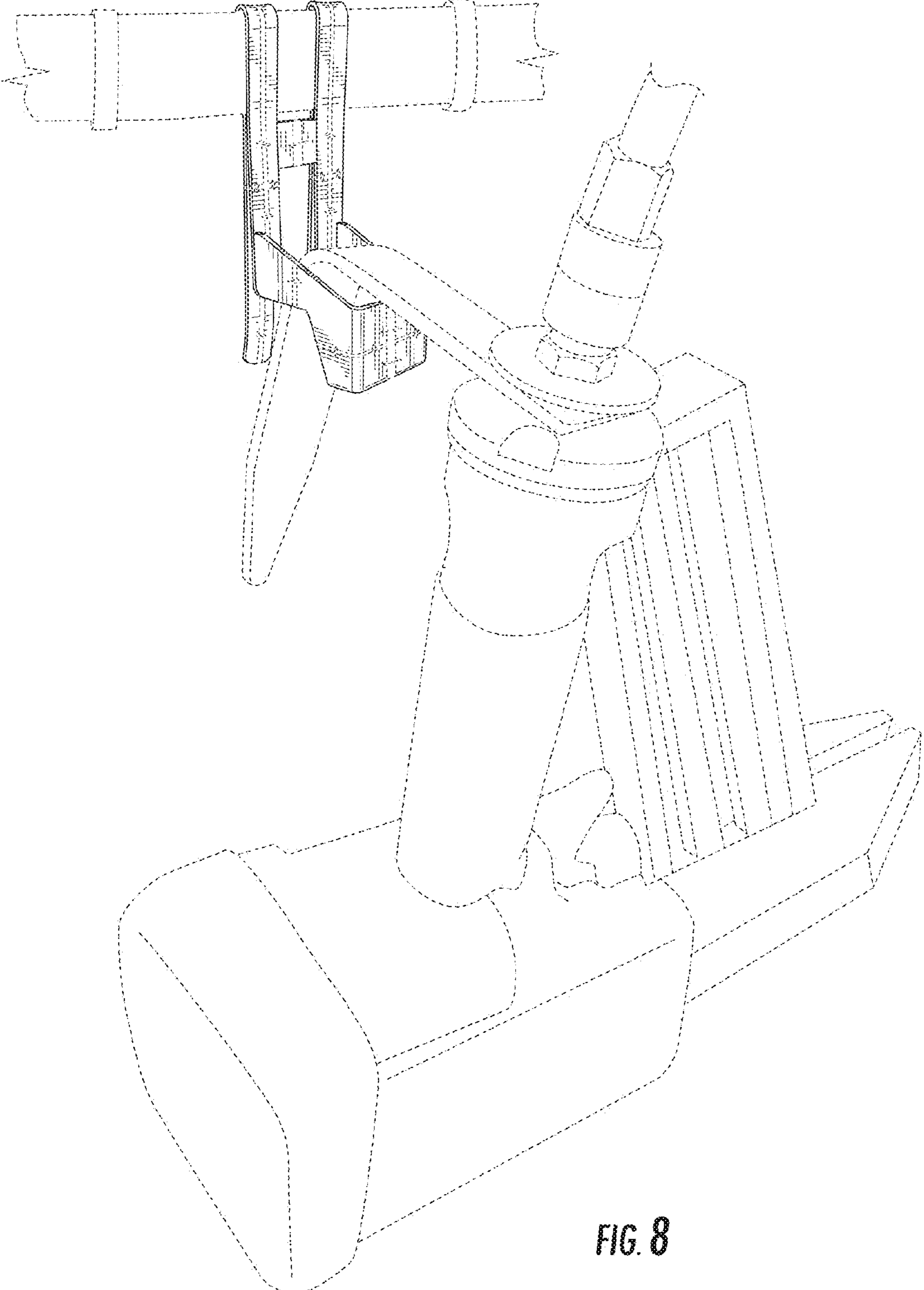

FIG. 8