



US00D738978S

(12) **United States Design Patent**
Winnicki

(10) **Patent No.:** **US D738,978 S**

(45) **Date of Patent:** **** Sep. 15, 2015**

(54) **JUDO EXERCISE PADDLE PAIR**

(71) Applicant: **Mariusz Winnicki**, Jackson, NJ (US)

(72) Inventor: **Mariusz Winnicki**, Jackson, NJ (US)

(**) Term: **14 Years**

(21) Appl. No.: **29/474,589**

(22) Filed: **Nov. 14, 2014**

(51) **LOC (10) Cl.** **21-02**

(52) **U.S. Cl.**
USPC **D21/798**

(58) **Field of Classification Search**

USPC D7/698, 699, 553.4, 555; D6/374, 716,
D6/375, 582, 601, 354, 406.3, 358;
D21/686, 688, 662, 671, 680, 682, 694,
D21/695, 690, 698, 699, 797, 369;
D24/190, 168; D29/120.1; D25/155;
D19/113, 26, 32; D3/203.2; D2/897,
D2/925, 950, 947; D26/37; 99/472, 467;
269/14, 289 R, 13, 15; 156/250, 256,
156/272.8, 308.2, 330, 60; 206/216;
224/257; 5/420; 428/80

See application file for complete search history.

(56) **References Cited**

U.S. PATENT DOCUMENTS

D281,005 S *	10/1985	Larsen	D21/694
D376,944 S *	12/1996	Dunn	D6/582
D390,288 S *	2/1998	Fingleson et al.	D21/686
D430,627 S *	9/2000	Bergman	D21/686
7,207,932 B1 *	4/2007	Dean	482/140
D554,208 S *	10/2007	Palaszek	D21/662
D626,775 S *	11/2010	Deenadayalu et al.	D6/601
D646,517 S *	10/2011	Noonan	D6/582
D651,032 S *	12/2011	Adkins	D6/596
D657,987 S *	4/2012	Lane	D6/582
D674,225 S *	1/2013	Boyer	D6/582
D707,057 S *	6/2014	Hasta	D6/582
2006/0040811 A1 *	2/2006	Foster	482/142
2012/0324645 A1 *	12/2012	Lehr	5/420
2014/0069970 A1 *	3/2014	Thomas, Jr.	224/257

* cited by examiner

Primary Examiner — Robert M Spear

Assistant Examiner — Ryan Harvey

(74) *Attorney, Agent, or Firm* — Charles I. Brodsky

(57) **CLAIM**

The ornamental design for a judo exercise paddle pair, as shown and described.

DESCRIPTION

FIG. 1 is a top perspective view of a first paddle of the judo exercise paddle pair showing my new design;
 FIG. 2 is a top plan view of the first paddle of the judo exercise paddle pair of my design;
 FIG. 3 is a bottom plan view thereof;
 FIG. 4 is a front elevation view of the first paddle of my paddle pair design;
 FIG. 5 is a rear elevation view thereof;
 FIG. 6 is a left side elevation view of the first paddle of my paddle pair design;
 FIG. 7 is a right side elevation view thereof;
 FIG. 8 is a top perspective view of a second paddle of the judo exercise paddle pair showing my new design;
 FIG. 9 is a top plan view of the second paddle of the judo exercise paddle pair of my design;
 FIG. 10 is a bottom plan view thereof;
 FIG. 11 is a front elevation view of the second paddle of my paddle pair design;
 FIG. 12 is a rear elevation view thereof;
 FIG. 13 is a left side elevation view of the second paddle of my paddle pair design;
 FIG. 14 is a right side elevation view thereof; and,
 FIG. 15 is a perspective view of both paddles of my judo exercise paddle pair, wherein the broken lines indicate an environment of use.
 The broken lines in FIG. 15 illustrate a connecting cord that forms no part of the claimed design. The smaller broken lines in all figures represent claimed stitching.

1 Claim, 11 Drawing Sheets

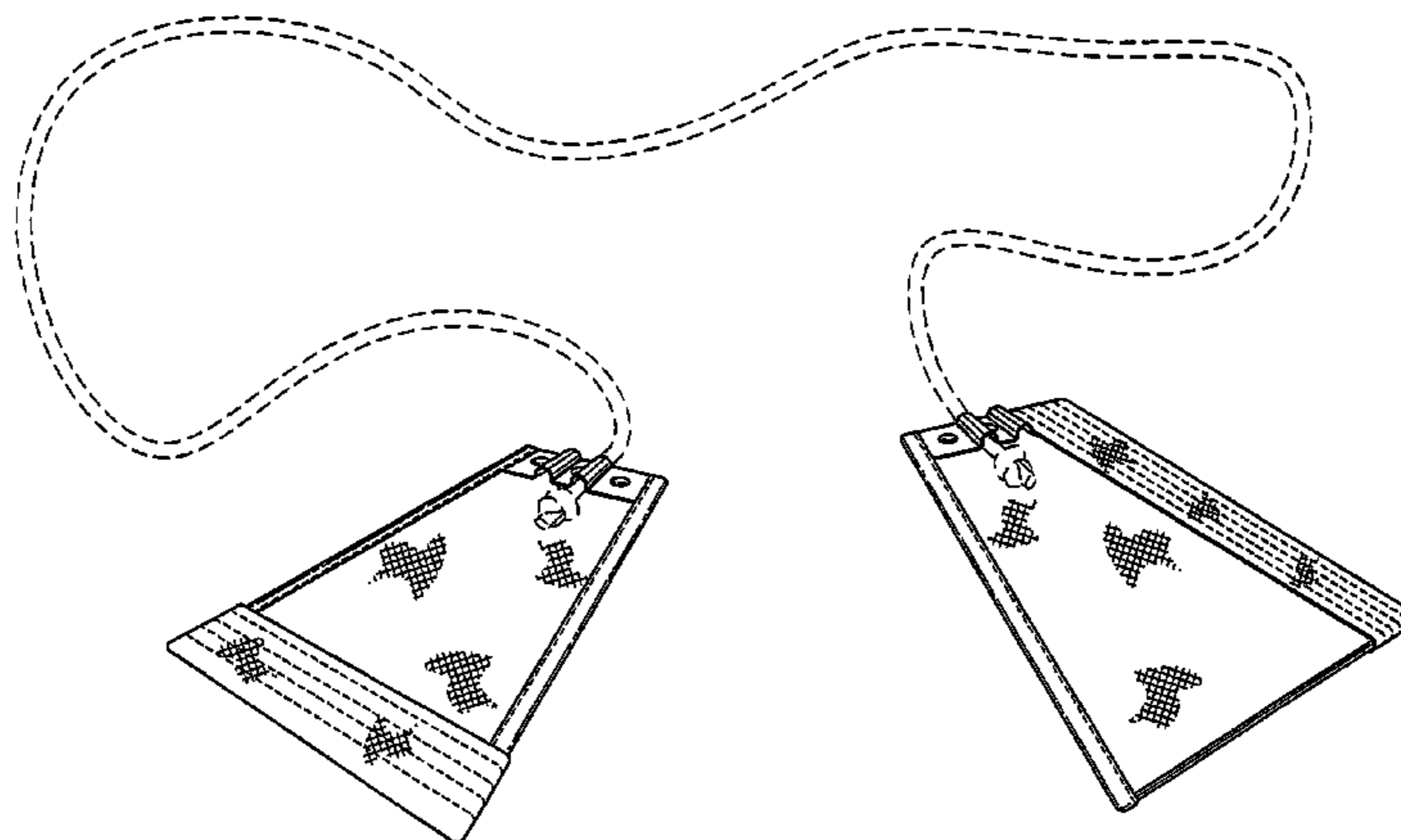

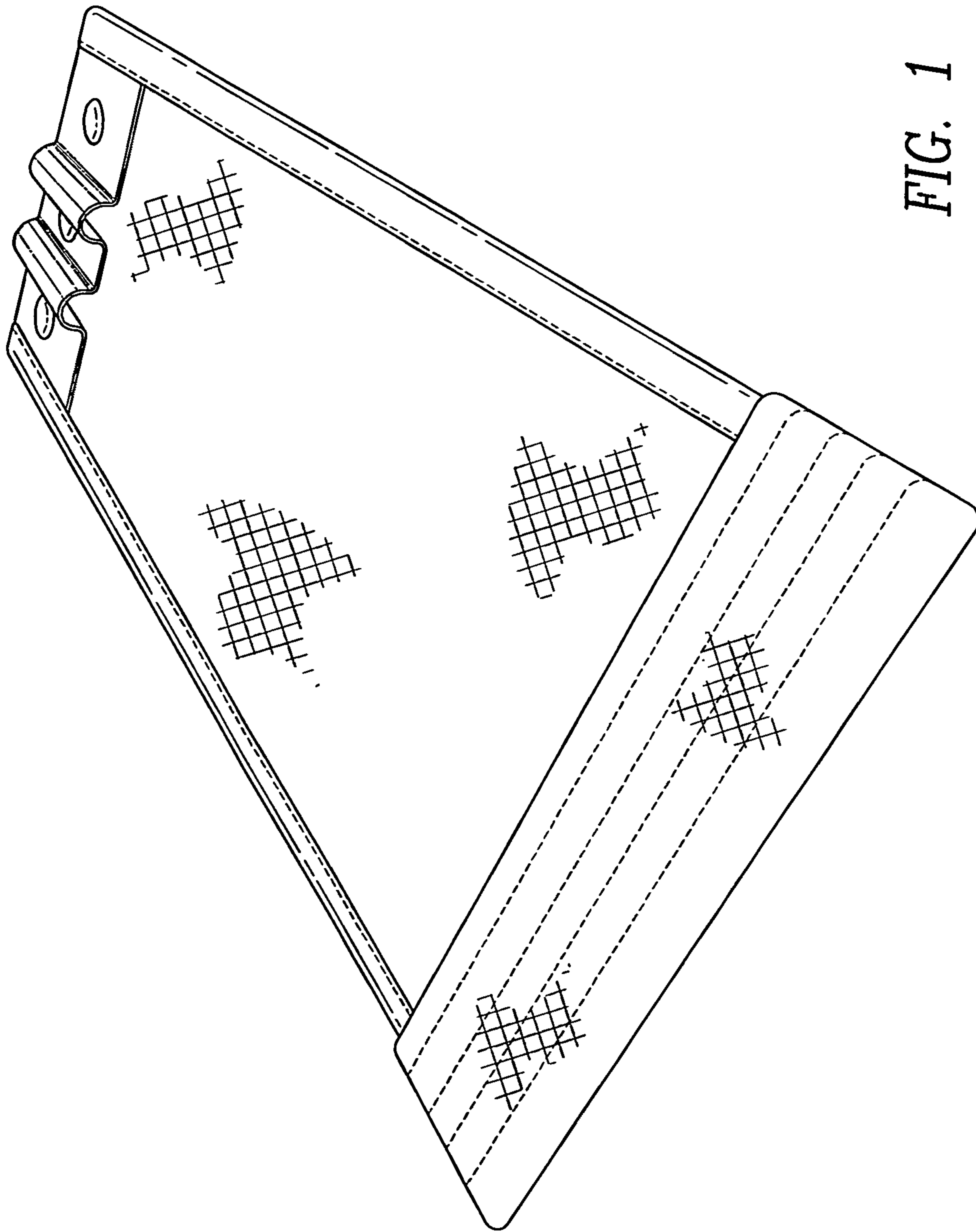

FIG. 1

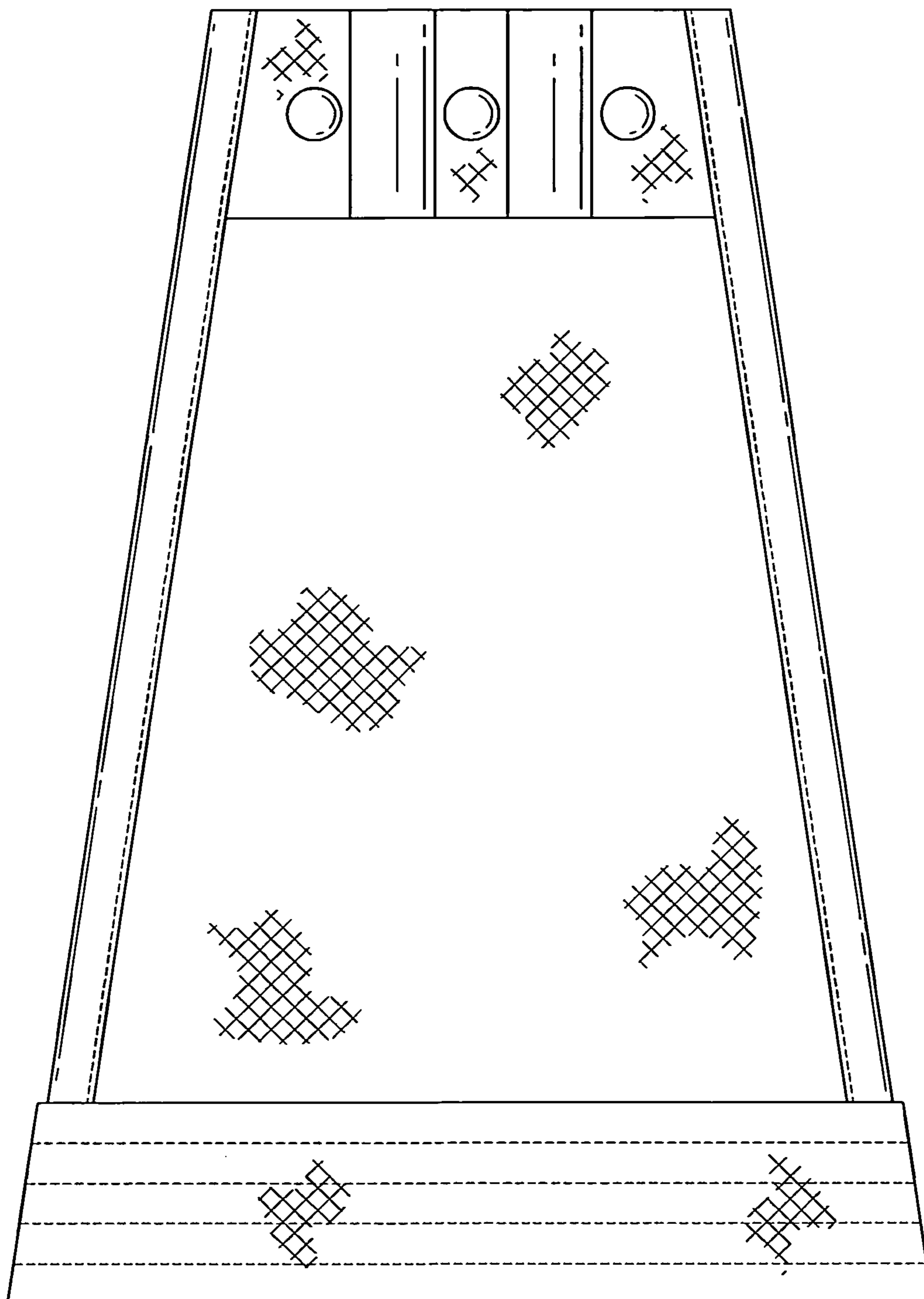

FIG. 2

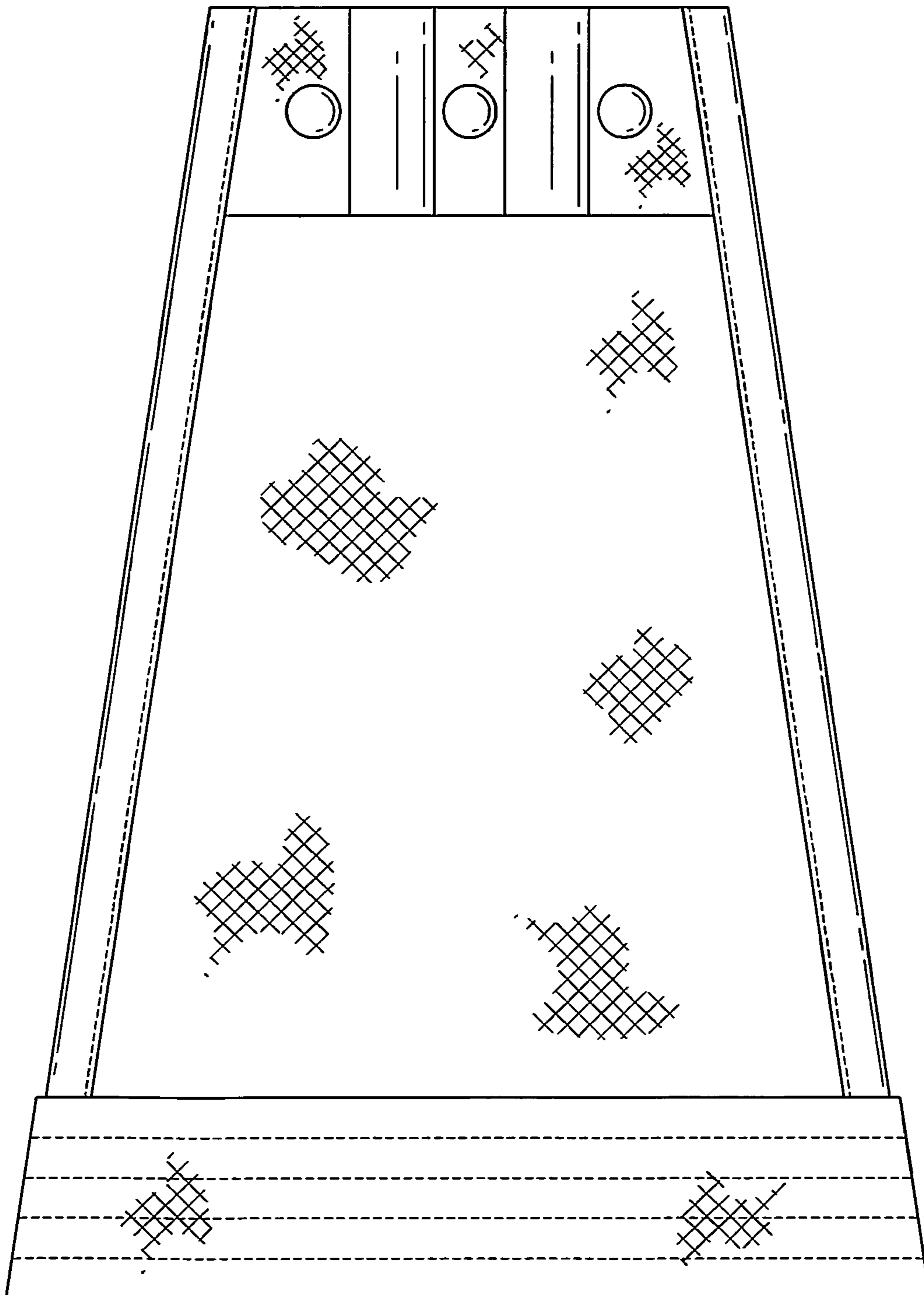

FIG. 3

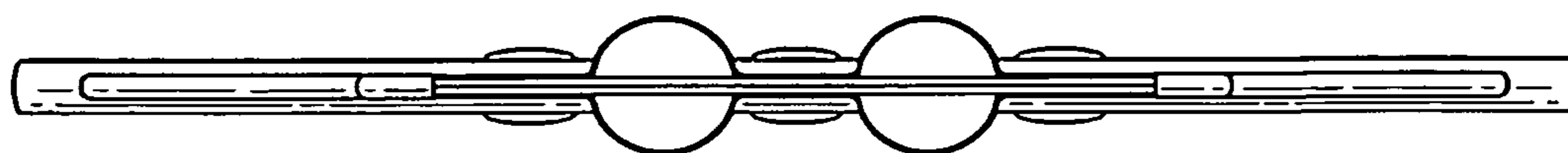

FIG. 4

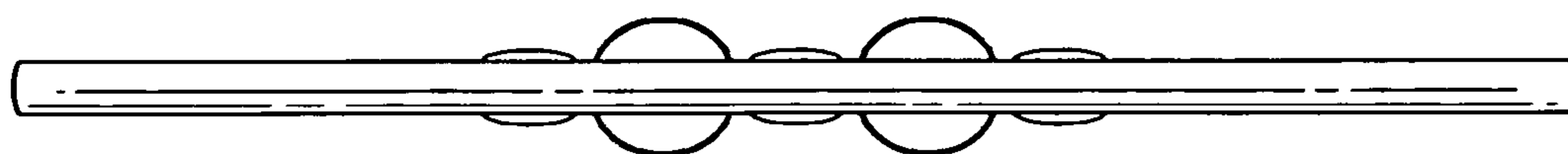

FIG. 5

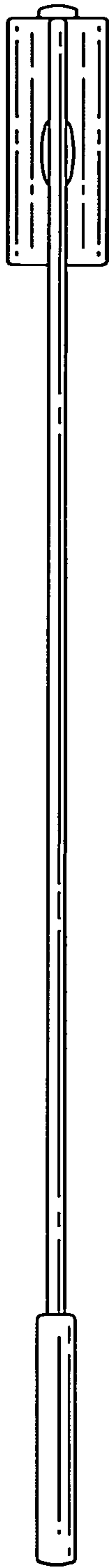

FIG. 6

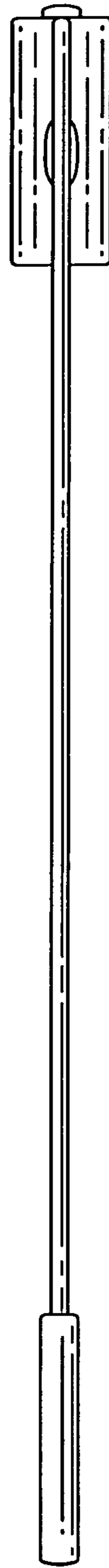

FIG. 7

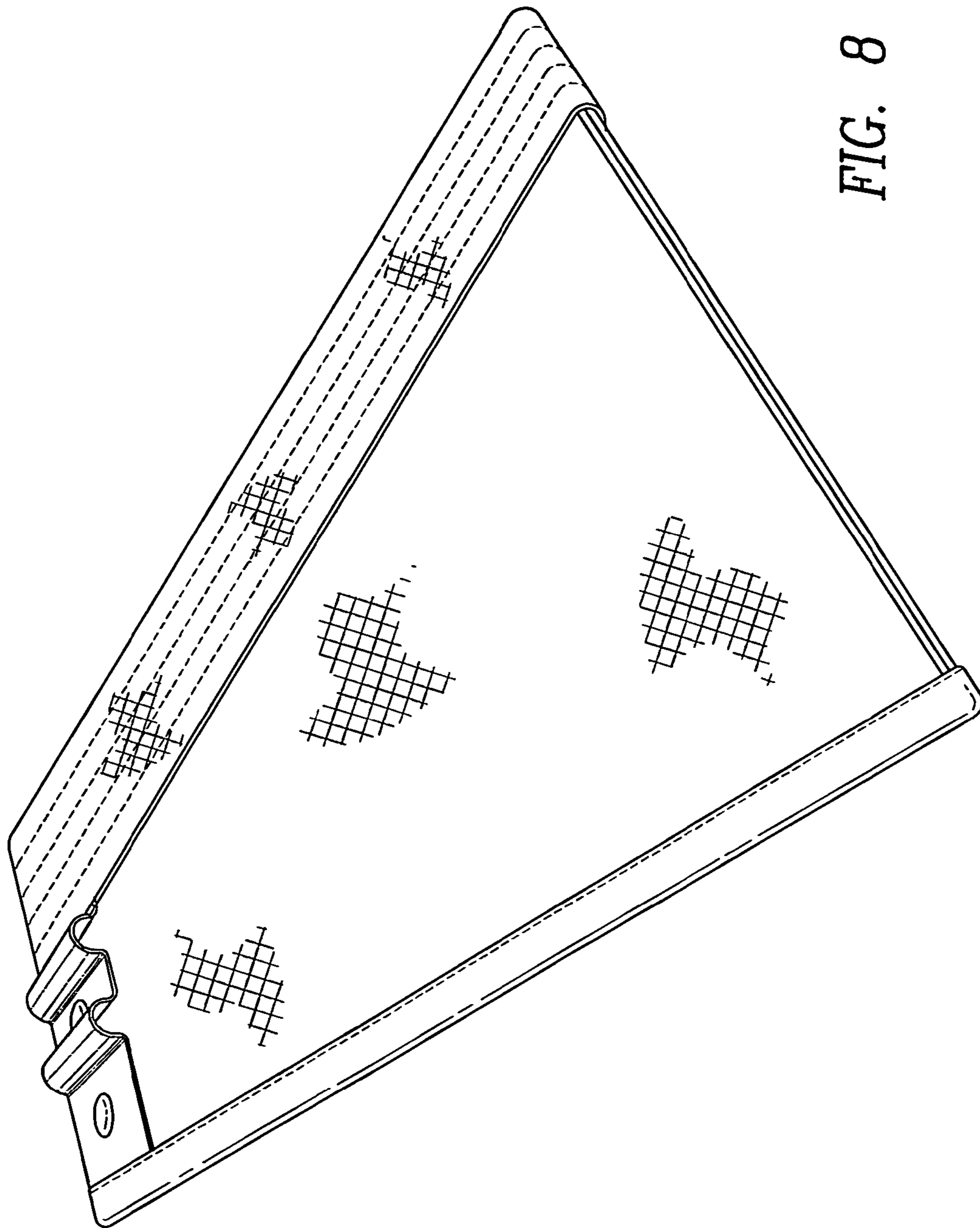

FIG. 8

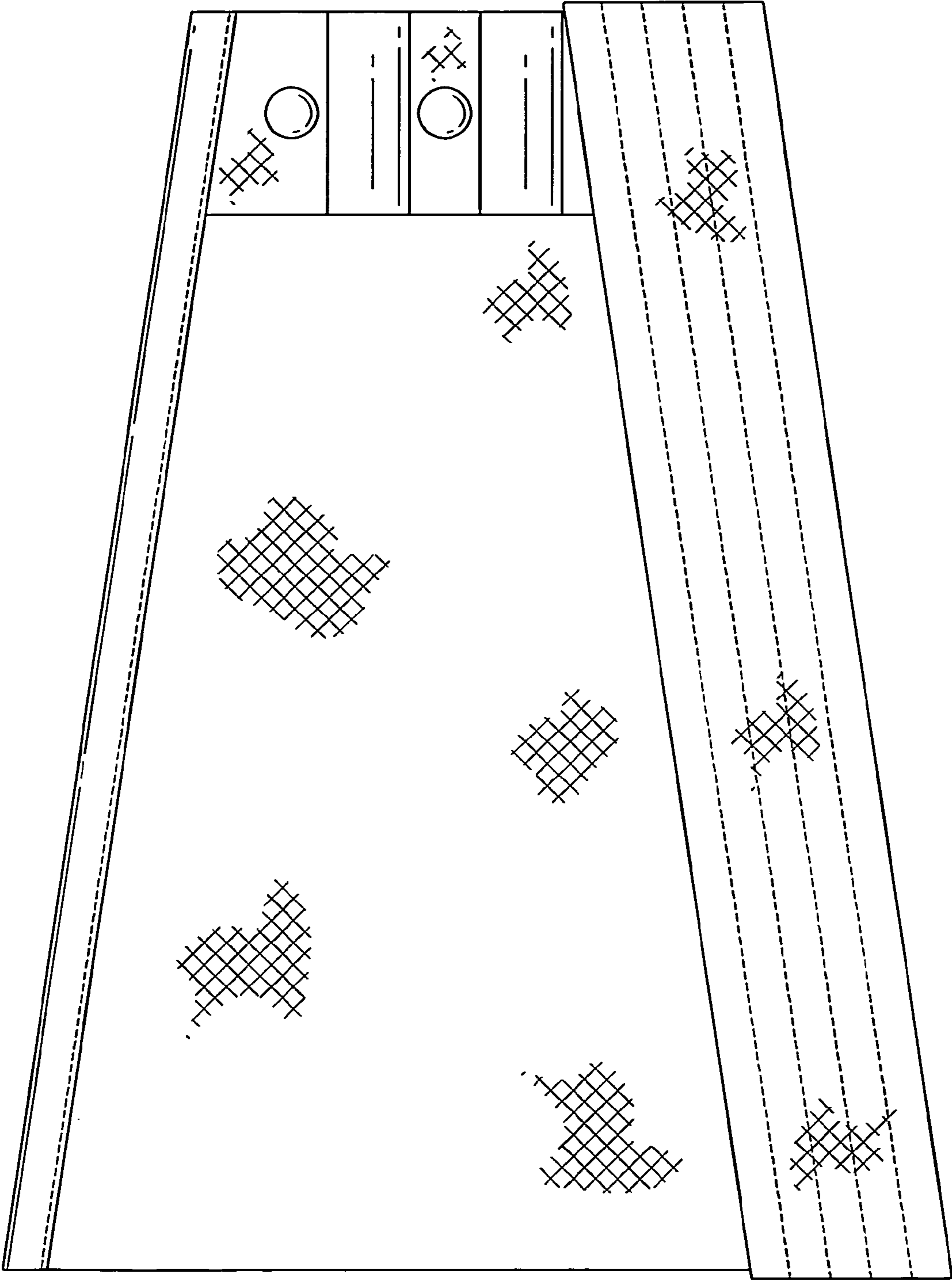

FIG. 9

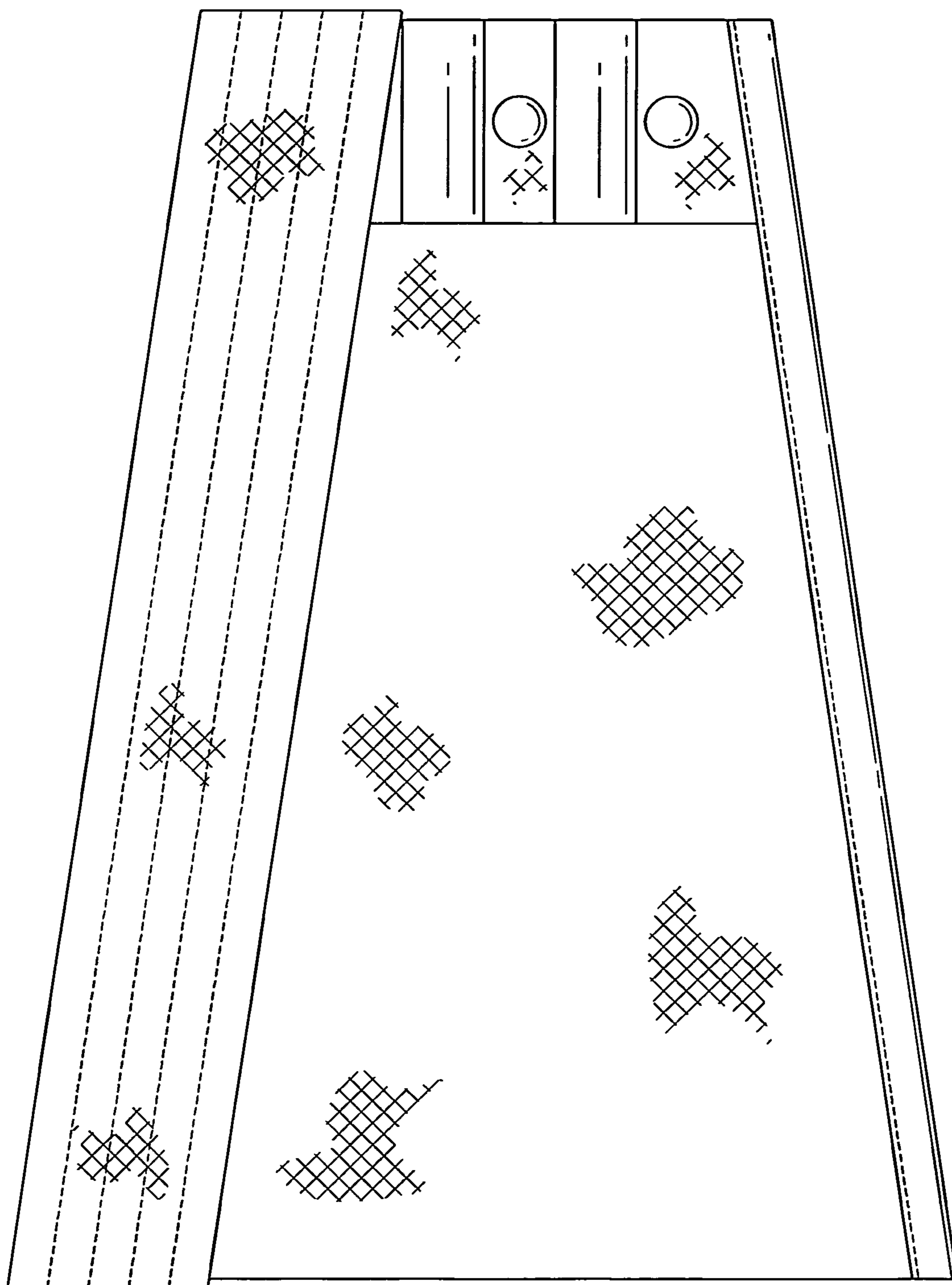

FIG. 10

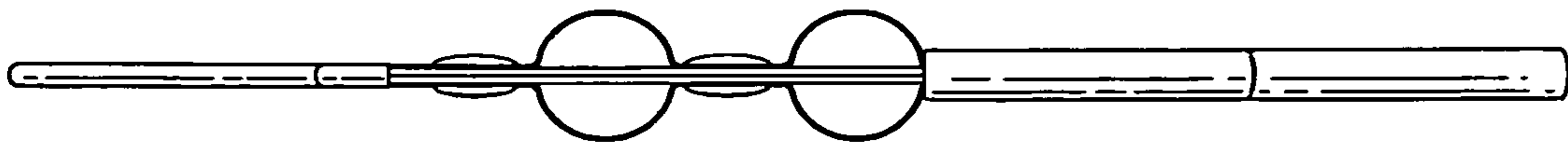

FIG. 11

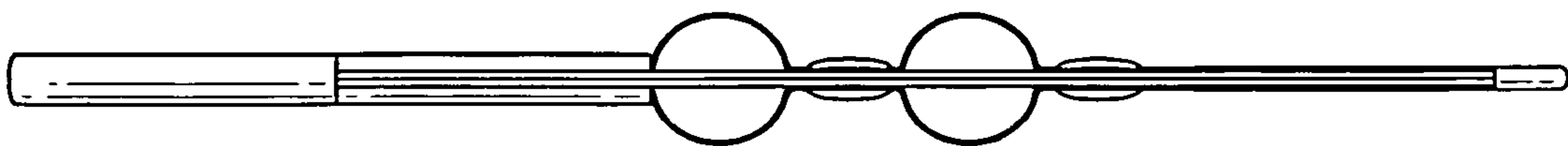

FIG. 12

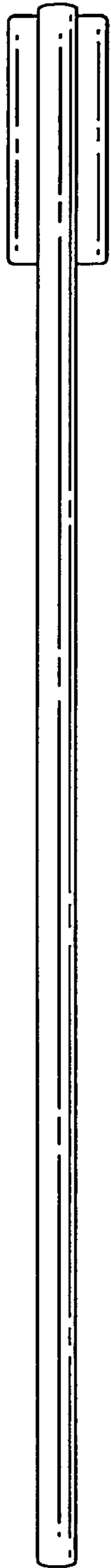

FIG. 13

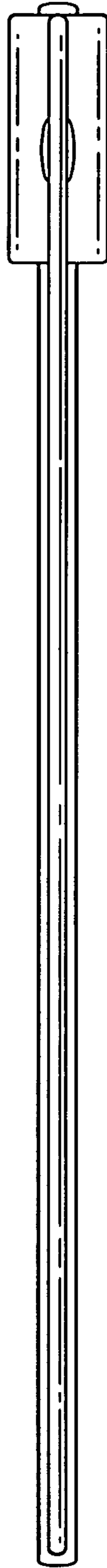

FIG. 14

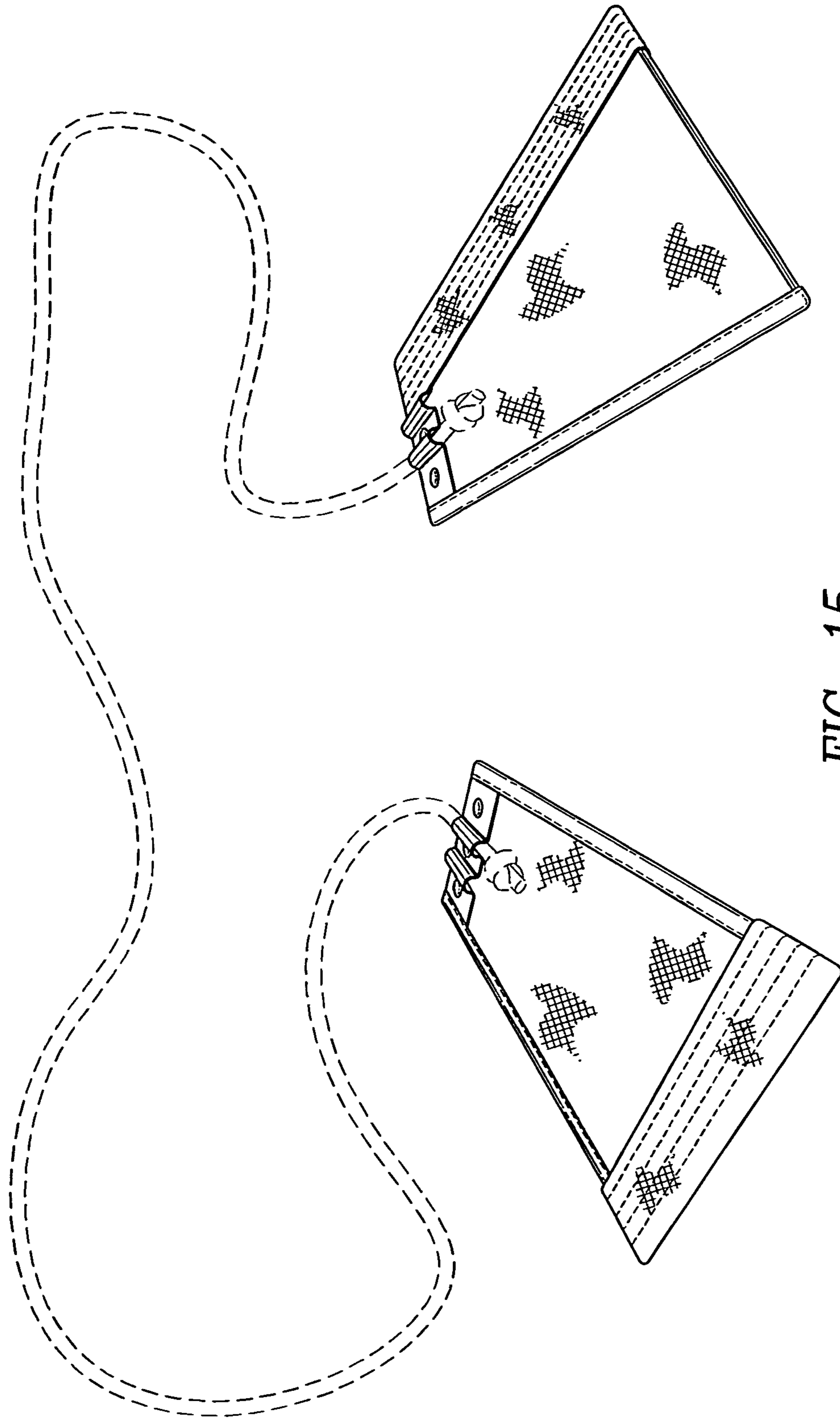

FIG. 15