



US00D738963S

(12) **United States Design Patent**
Bogen et al.

(10) **Patent No.:** **US D738,963 S**
(45) **Date of Patent:** **** Sep. 15, 2015**

(54) **PUZZLEBALL**

(71) Applicant: **Zurreball AS**, Oslo (NO)

(72) Inventors: **Line Bogen**, Oslo (NO); **Petter Bogen**, Oslo (NO)

(73) Assignee: **ZURREBALL AS** (NO)

(**) Term: **14 Years**

(21) Appl. No.: **29/475,135**

(22) Filed: **Nov. 29, 2013**

(30) **Foreign Application Priority Data**

May 31, 2013 (WO) DM/081 127

(51) **LOC (10) Cl.** **21-01**

(52) **U.S. Cl.**
USPC **D21/478**

(58) **Field of Classification Search**

USPC D21/478-481, 707-714, 372, 373, 386,
D21/498, 499, 504, 505; D11/43, 44, 62,
D11/70, 75, 76, 78, 79, 81, 121, 124, 131,
D11/157; D30/160; 273/153 R, 156, 157 R,
273/160, 153 S; 473/351, 378-383, 569,
473/570, 571, 575-577, 594-597,
473/600-615; 40/327; 446/431, 438, 439;
119/707-711; 428/11

See application file for complete search history.

(56) **References Cited**

U.S. PATENT DOCUMENTS

D269,629 S * 7/1983 Wiggs et al. D21/478
4,781,380 A * 11/1988 Irwin 273/153 S
D369,630 S * 5/1996 Balanchi D21/479

D393,020 S * 3/1998 Arcos D21/479
5,816,571 A * 10/1998 Chen 273/153 S
6,089,402 A * 7/2000 Pracas 221/288
6,244,597 B1 * 6/2001 Matijek 273/153 S
6,562,423 B2 * 5/2003 Rubin 428/13
6,592,122 B2 * 7/2003 Ikenaga 273/153 S
7,108,263 B2 * 9/2006 Cabeza et al. 273/153 S
D604,370 S * 11/2009 Hume D21/478
7,823,884 B2 * 11/2010 Cantner 273/153 S
D642,339 S * 7/2011 Levin et al. D30/160
D646,735 S * 10/2011 Nichols et al. D21/707
D690,785 S * 10/2013 Silvergate D21/713
2005/0269770 A1 * 12/2005 Mak 273/153 R
2007/0057456 A1 * 3/2007 Liu 273/153 S
2008/0090486 A1 * 4/2008 Zawitz 446/124
2009/0091080 A1 * 4/2009 Paquette 273/153 S
2010/0117297 A1 * 5/2010 Spencer-Purvis 273/153 S
2010/0276881 A1 * 11/2010 Tu 273/241

FOREIGN PATENT DOCUMENTS

CN 3253700 * 9/2002
GB 4022833 * 1/2012

* cited by examiner

Primary Examiner — Catherine Tuttle

(74) *Attorney, Agent, or Firm* — Kolisch Hartwell, P.C.

(57) **CLAIM**

I claim the ornamental design for a puzzleball, as shown.

DESCRIPTION

FIG. 1 is a top rear perspective view of the puzzleball showing my new design;

FIG. 2 is a rear perspective view thereof;

FIG. 3 is a bottom, left and rear perspective view thereof;

FIG. 4 is a left and front perspective view thereof;

FIG. 5 is a front perspective view thereof; and,

FIG. 6 is a lower front perspective view thereof.

1 Claim, 6 Drawing Sheets

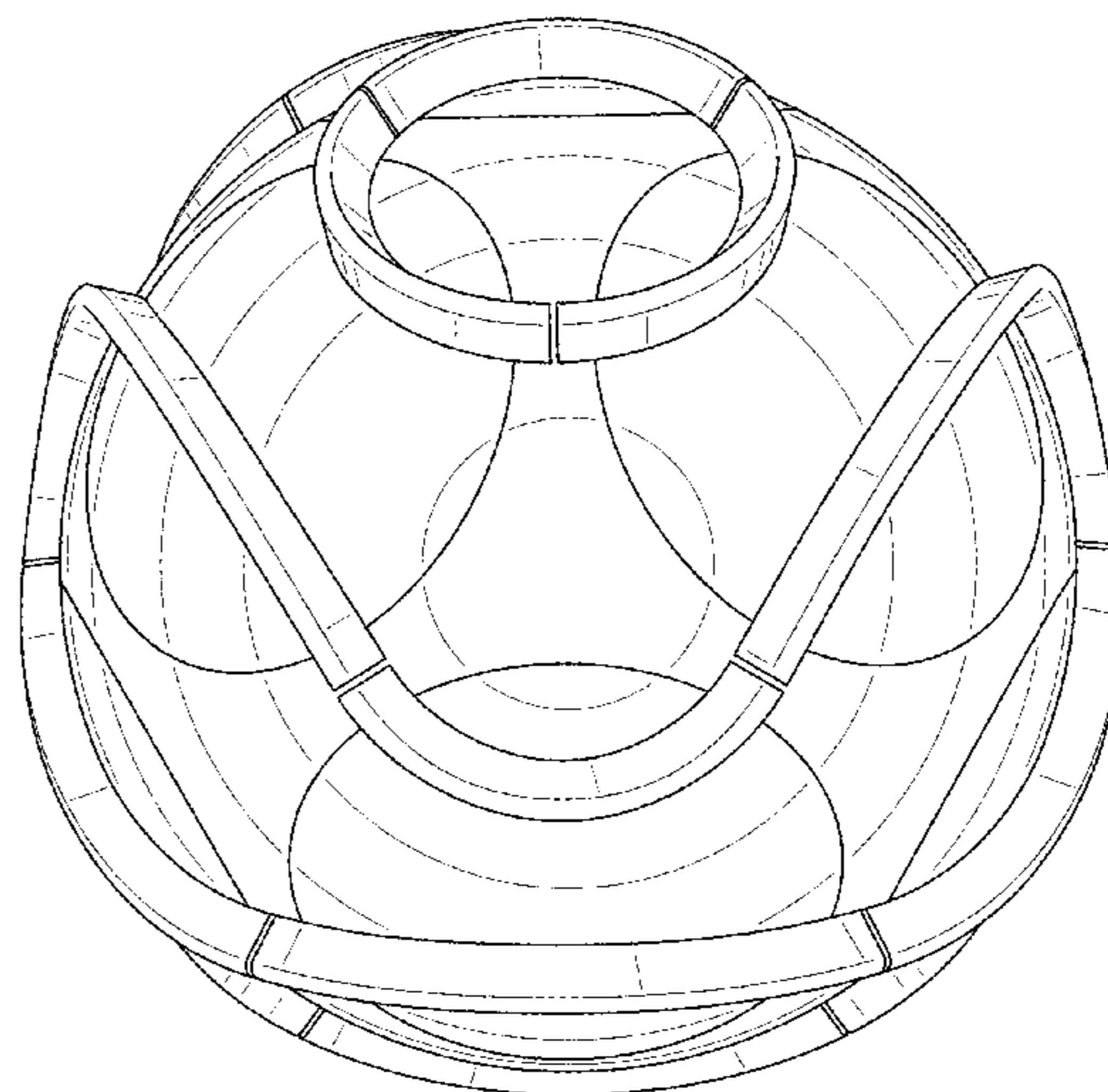
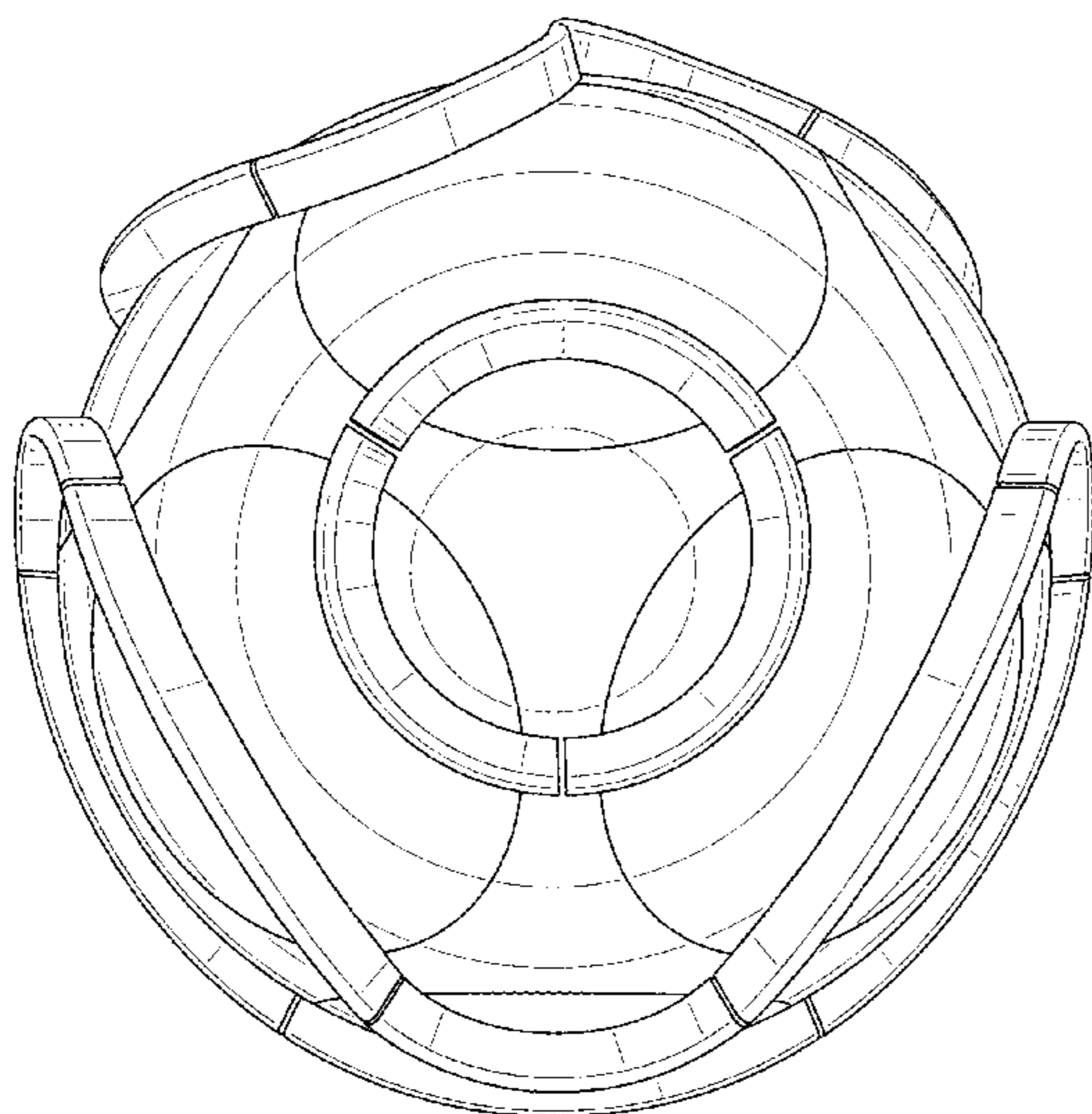

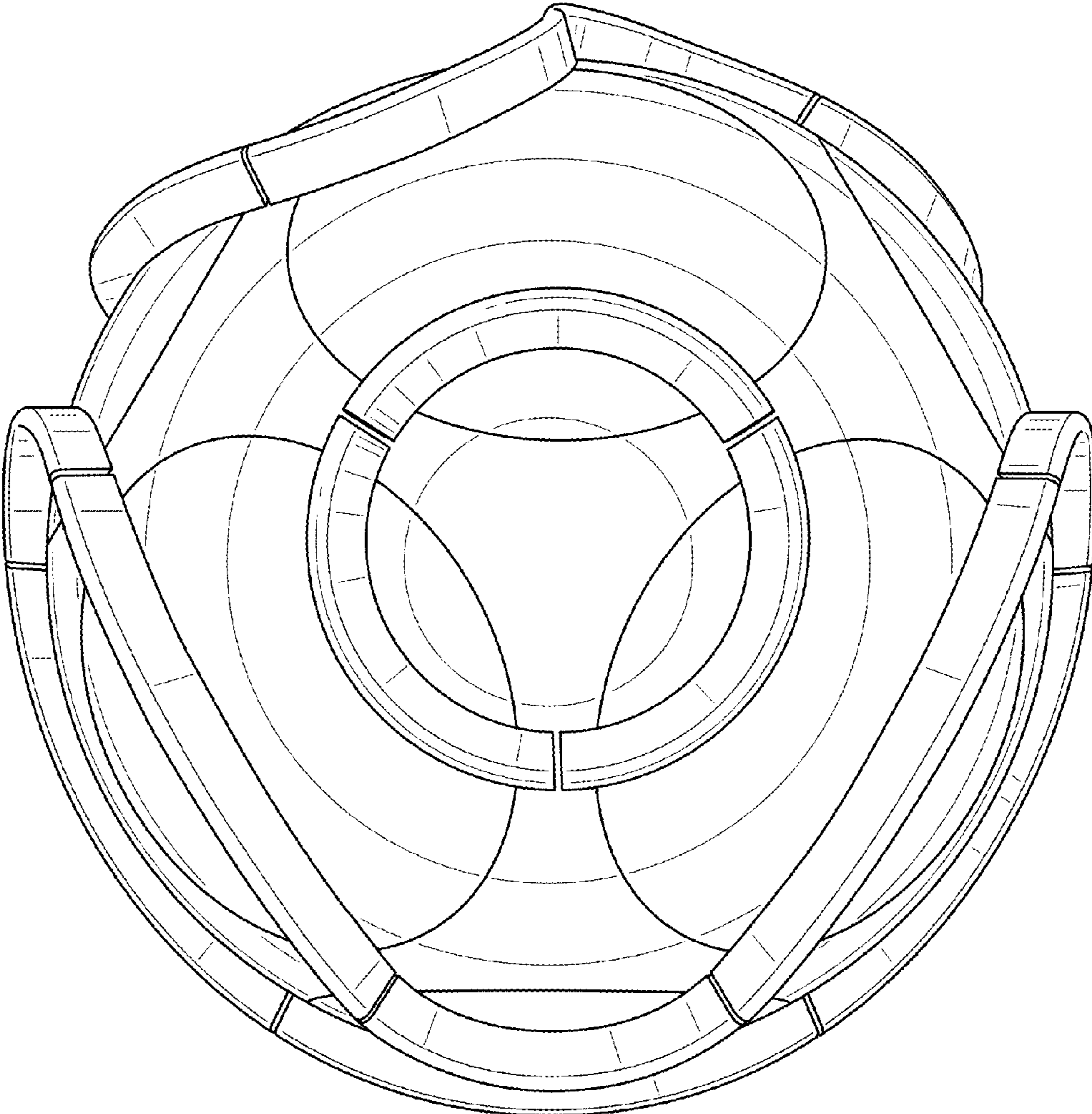

FIG. 1

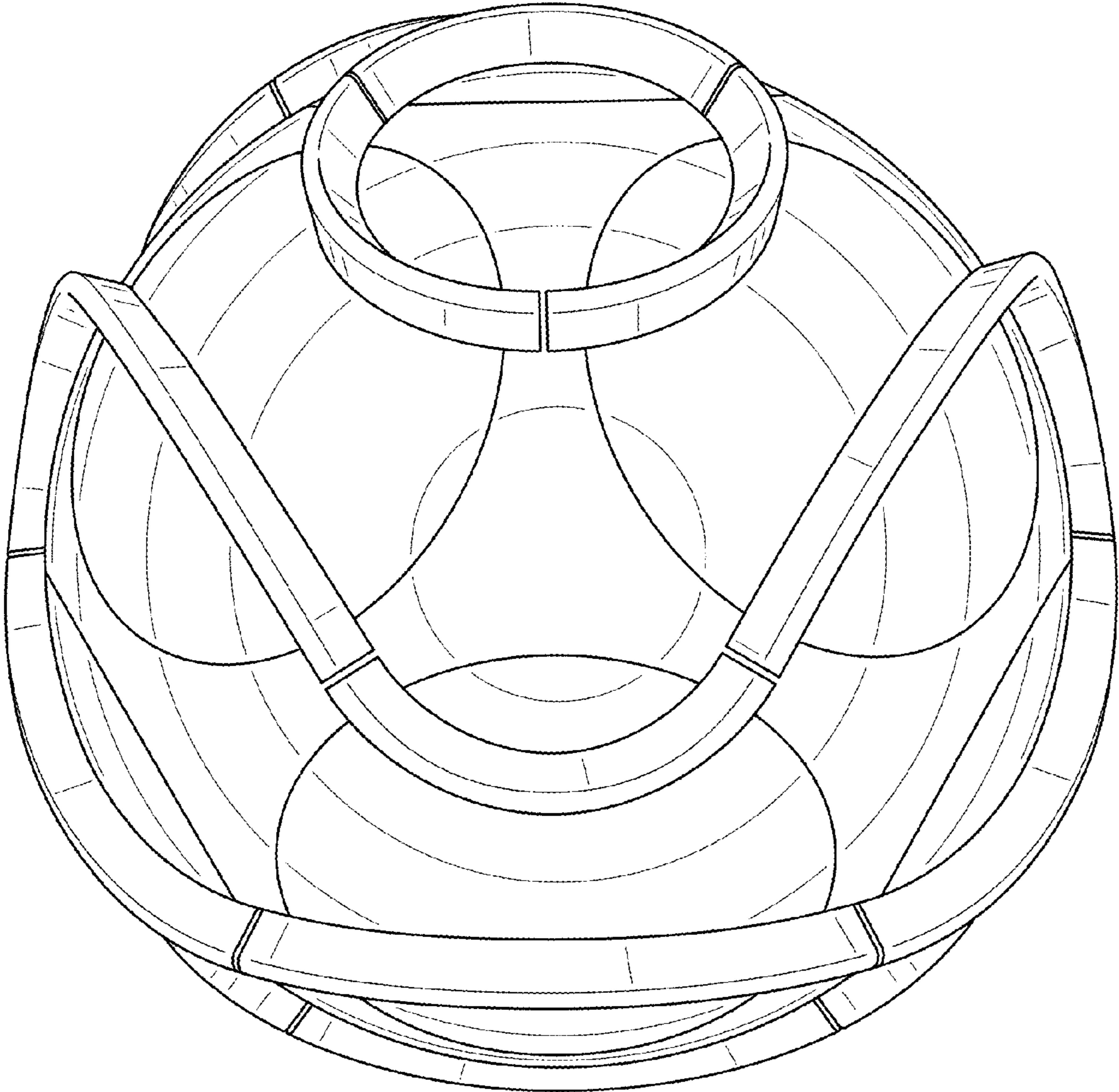

FIG. 2

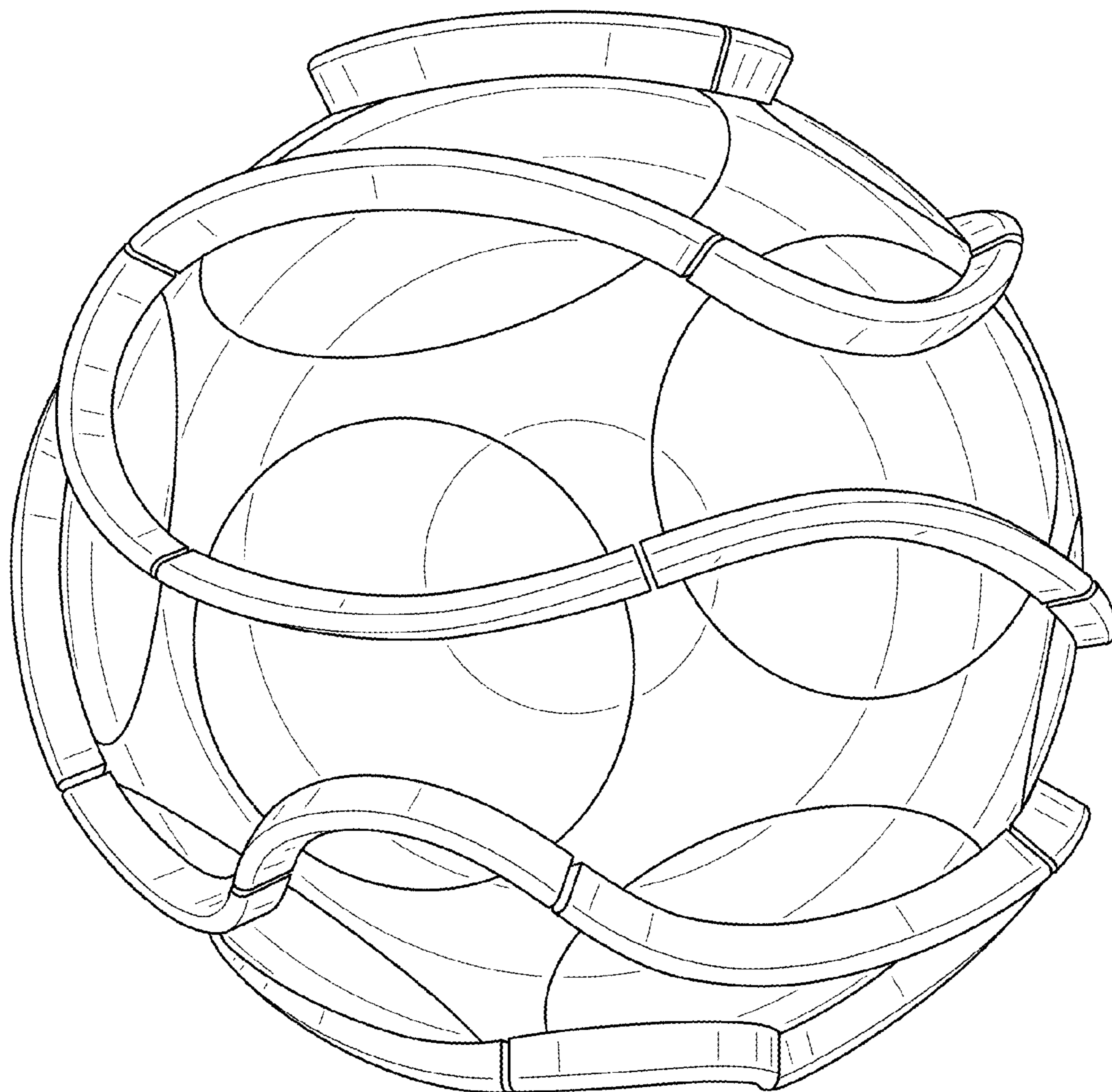

FIG. 3

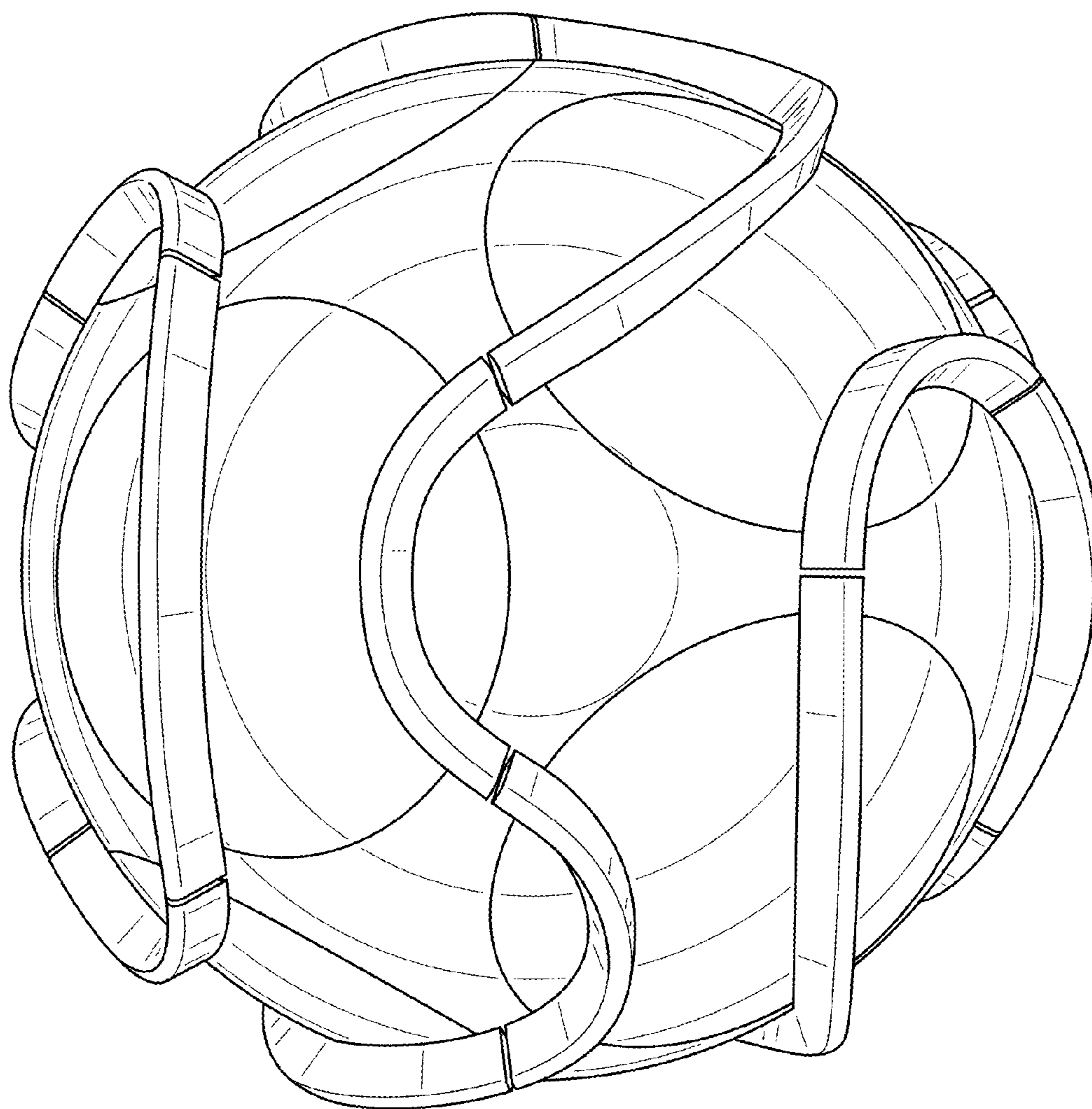

FIG. 4

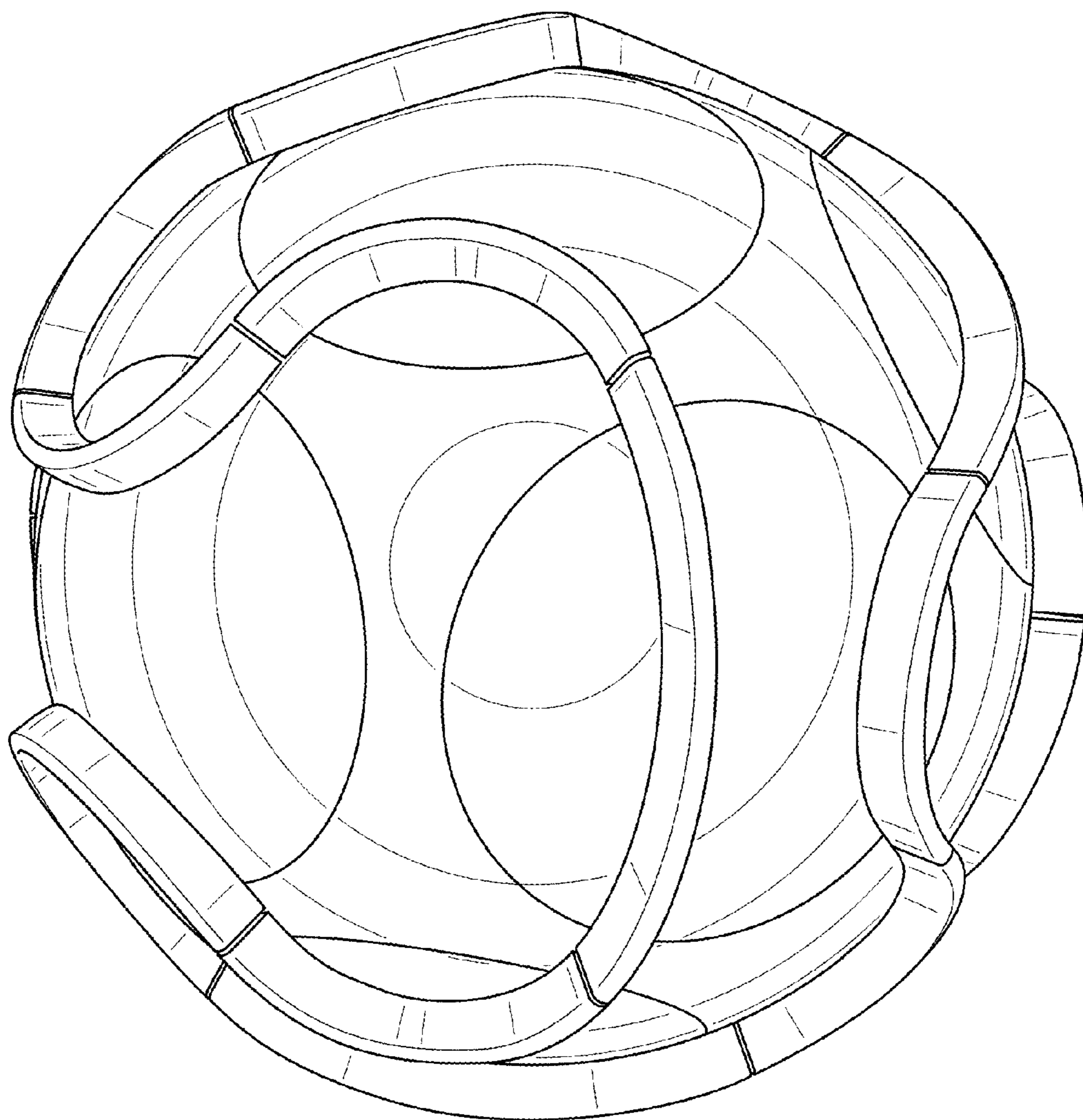

FIG. 5

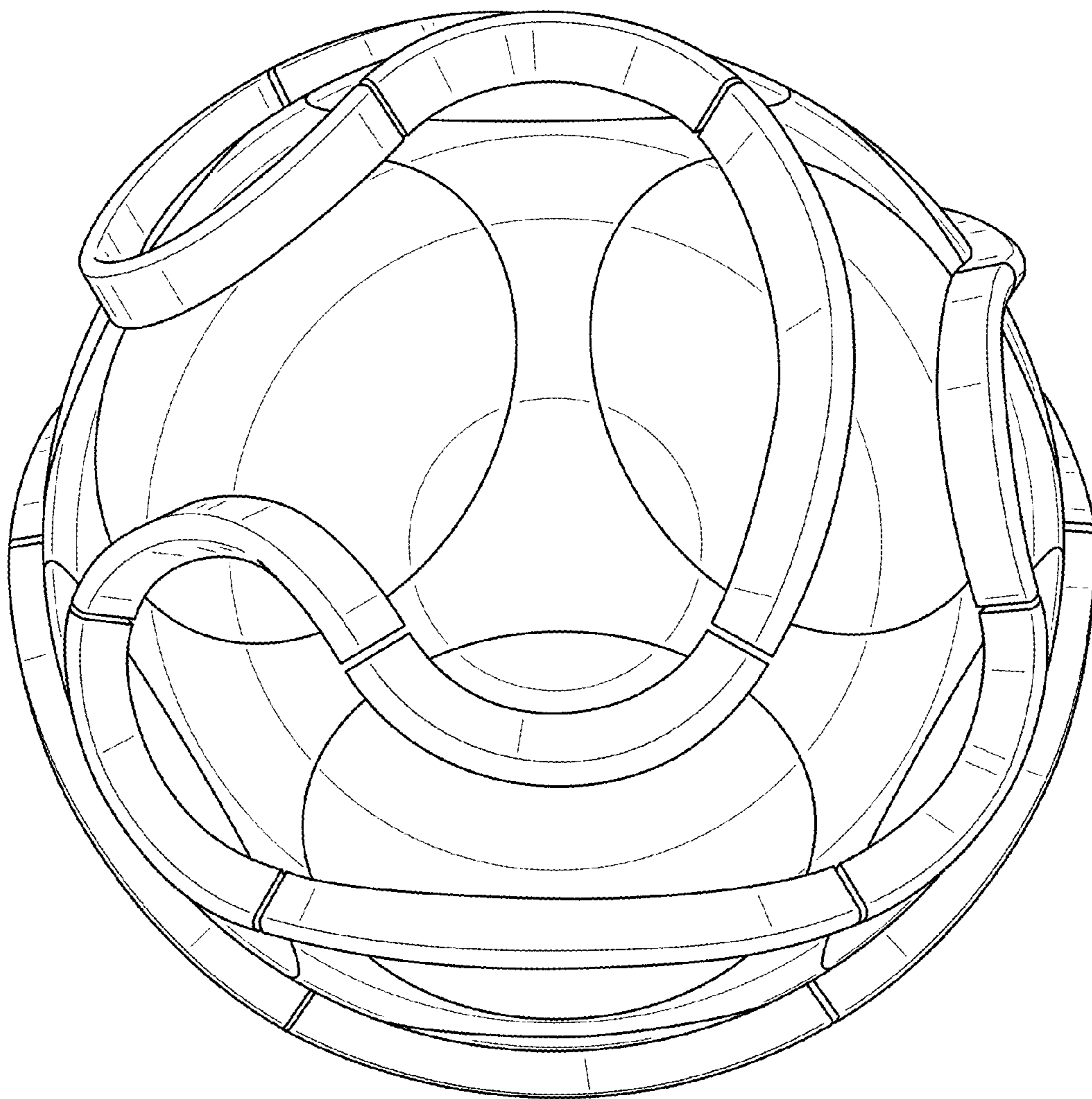

FIG. 6