



US00D738939S

(12) **United States Design Patent**  
**Seo et al.**

(10) **Patent No.:** **US D738,939 S**  
(45) **Date of Patent:** **\*\* Sep. 15, 2015**

(54) **CAMERA FOR REFRIGERATOR**

(71) Applicant: **LG Electronics Inc.**, Seoul (KR)

(72) Inventors: **Woonkyu Seo**, Seoul (KR); **Jinwon Kang**, Gyeonggi-do (KR); **Myungdong You**, Incheon (KR); **Daesung Lee**, Gyeonggi-do (KR)

(73) Assignee: **LG Electronics Inc.**, Seoul (KR)

(\*\*) Term: **14 Years**

(21) Appl. No.: **29/486,938**

(22) Filed: **Apr. 4, 2014**

(30) **Foreign Application Priority Data**

Oct. 7, 2013 (KR) ..... 30-2013-0050924

(51) **LOC (10) Cl.** ..... **15-07**

(52) **U.S. Cl.**  
USPC ..... **D15/89**; D16/208

(58) **Field of Classification Search**  
USPC ..... D15/79-91; D16/200, 208, 218, 219  
CPC ..... F25D 23/028; F25D 23/02; F25D 25/025;  
F25D 23/00; F25D 2323/021; F25D 11/00;  
F25D 2323/024; F25D 23/04; F25D 29/00;  
F25D 25/02; F25D 25/024; F25D 27/005;  
F25D 23/12; F25D 29/005; F25D 17/042;  
F25D 2325/021; G03B 17/02; G03B 19/04;  
G03B 17/56; G03B 17/04; G03B 15/03;  
H04N 5/2251; H04N 5/2252; H04N 5/2253;  
H04N 5/2254; H04N 2007/145; H04N 7/141;  
H04N 7/142; H04N 7/147; H04N 7/148;  
H04N 7/15; H04N 7/152

See application file for complete search history.

(56) **References Cited**

U.S. PATENT DOCUMENTS

D556,233	S	*	11/2007	Webb et al.	.....	D16/203
D556,235	S	*	11/2007	Todd et al.	.....	D16/203
D568,912	S	*	5/2008	Shin et al.	.....	D15/89
D628,222	S	*	11/2010	Tzeng et al.	.....	D16/202
D721,119	S	*	1/2015	Nuk et al.	.....	D16/219
D724,117	S	*	3/2015	Jeon et al.	.....	D15/89

\* cited by examiner

*Primary Examiner* — Daniel Bui

*Assistant Examiner* — Khawaja Anwar

(74) *Attorney, Agent, or Firm* — Morgan, Lewis & Bockius LLP

(57) **CLAIM**

The ornamental design for a camera for refrigerator, as shown and described.

**DESCRIPTION**

FIG. 1 is a front, right side, perspective view of a camera for refrigerator showing our new design; FIG. 2 is a front view thereof; FIG. 3 is a rear view thereof; FIG. 4 is a left side view thereof; FIG. 5 is a right side view thereof; FIG. 6 is a top view thereof; and, FIG. 7 is a bottom view thereof; FIG. 8 is a bottom, right side, perspective view thereof; and, FIG. 9 is a perspective view thereof, shown in use condition. The portion of the article shown in broken lines is for the purpose of showing environmental structure only and forms no part of the claimed design.

**1 Claim, 4 Drawing Sheets**

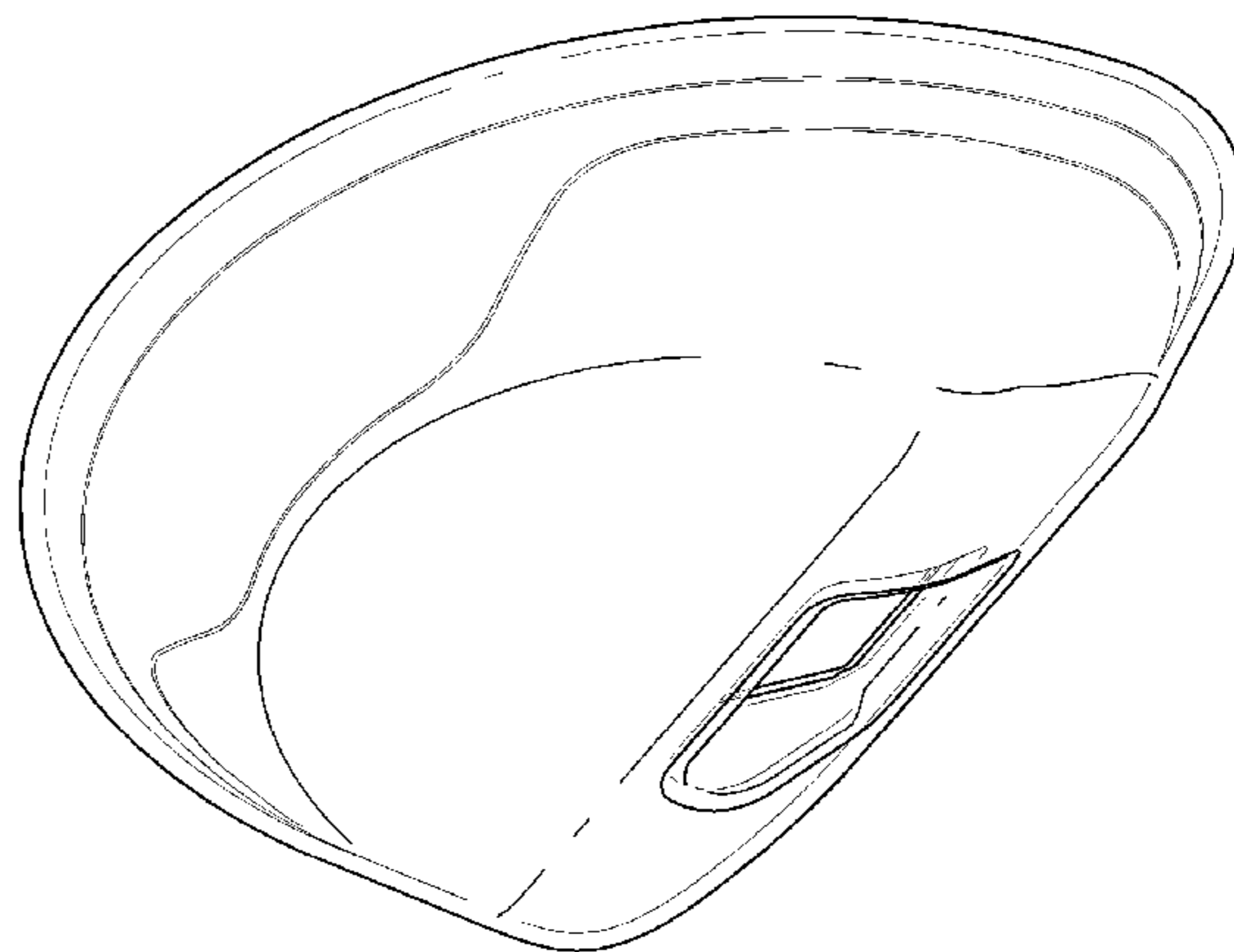
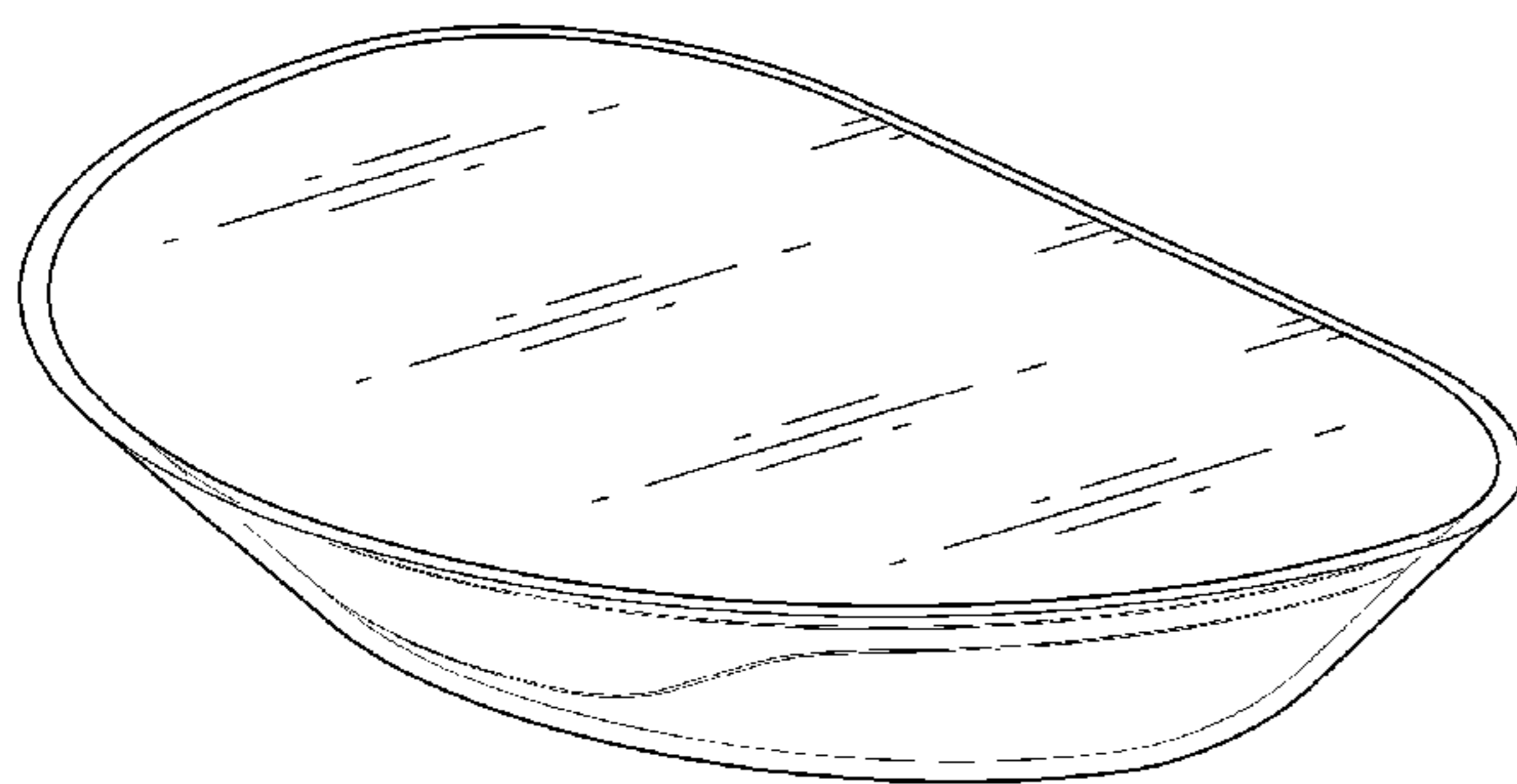

FIG. 1

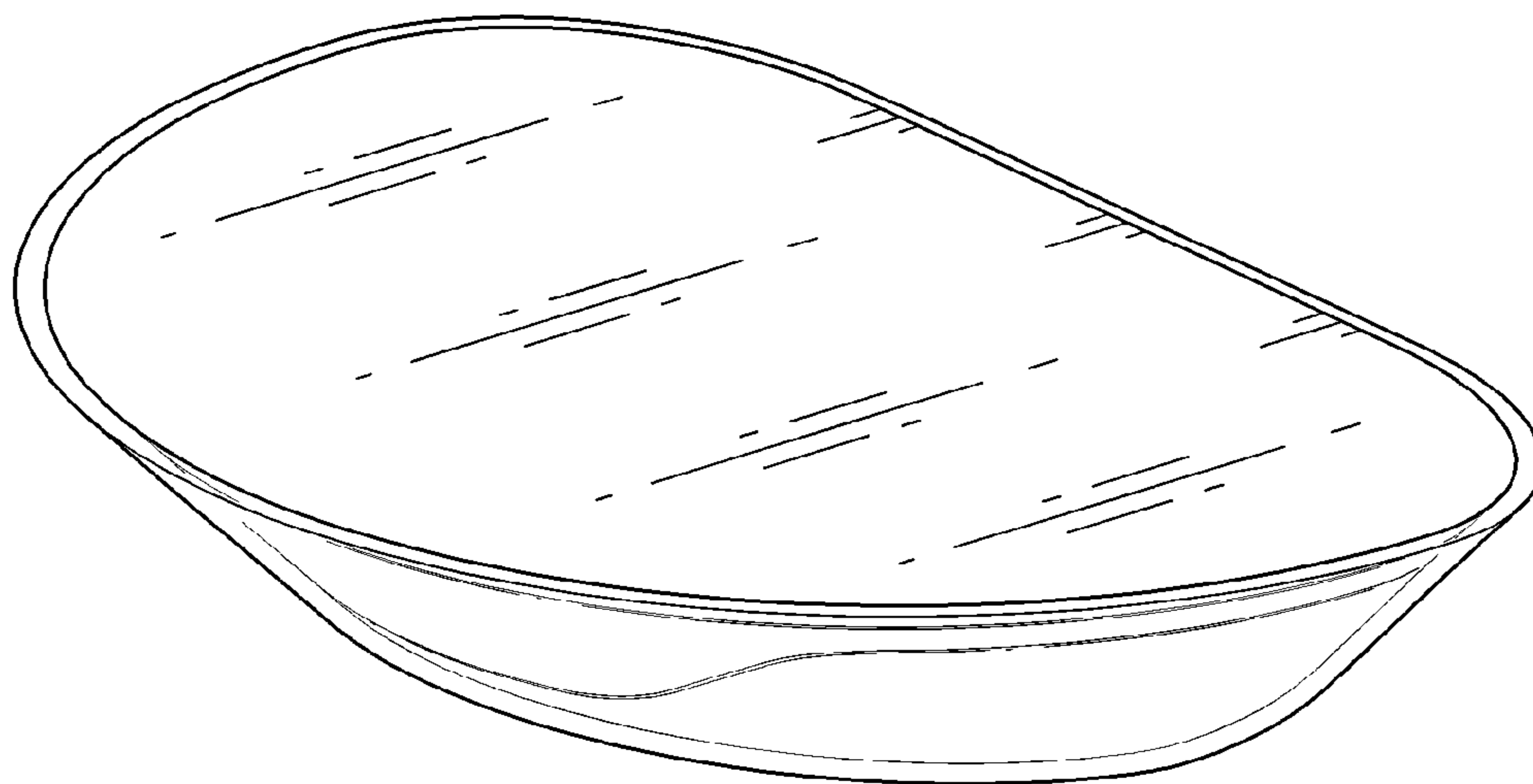

FIG. 2

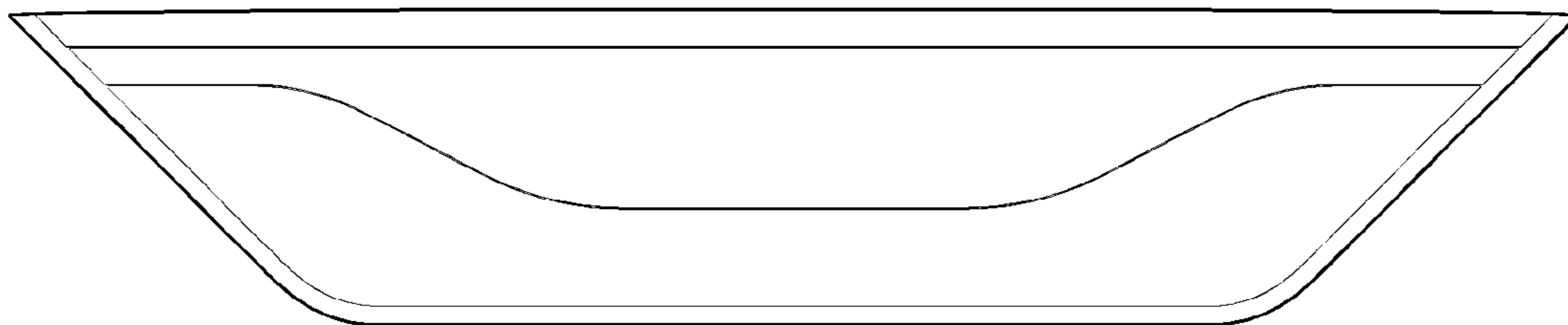

FIG. 3

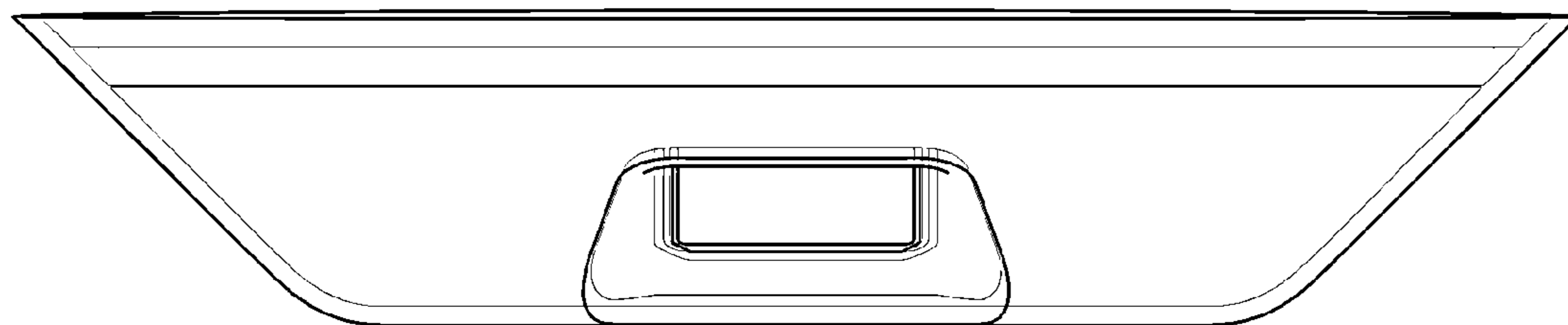

FIG. 4

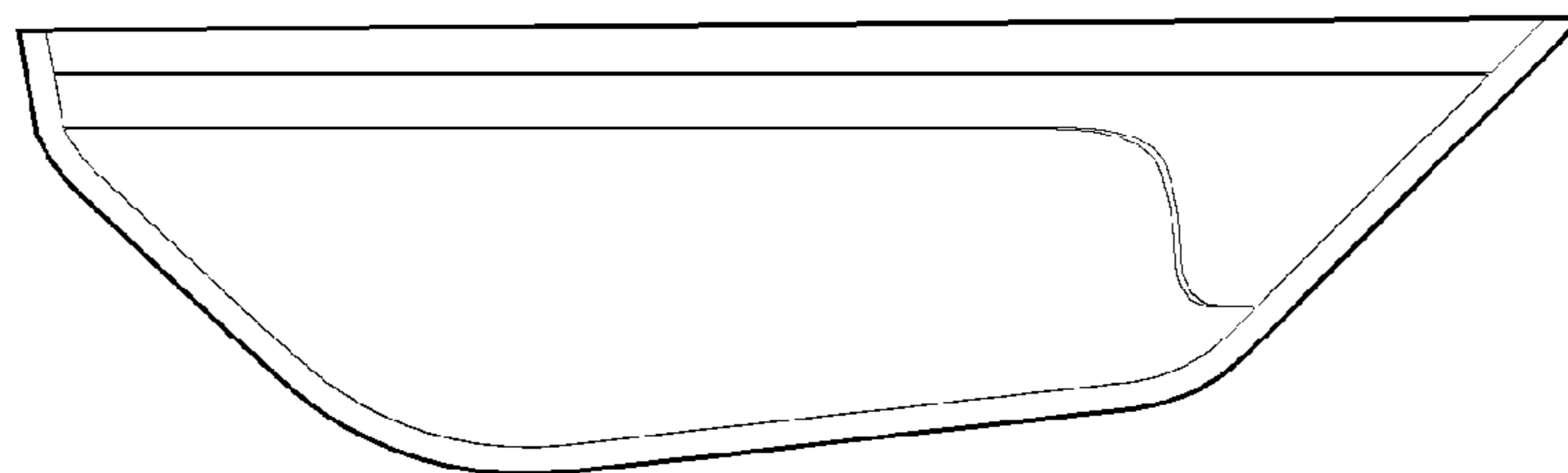

FIG. 5

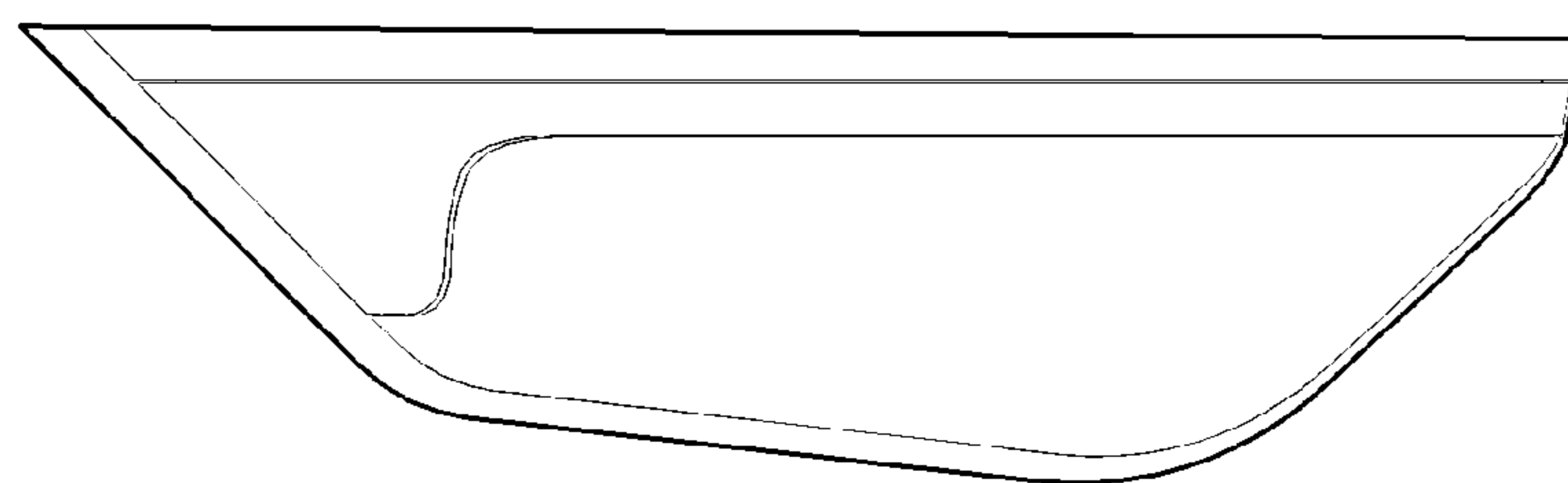

FIG. 6

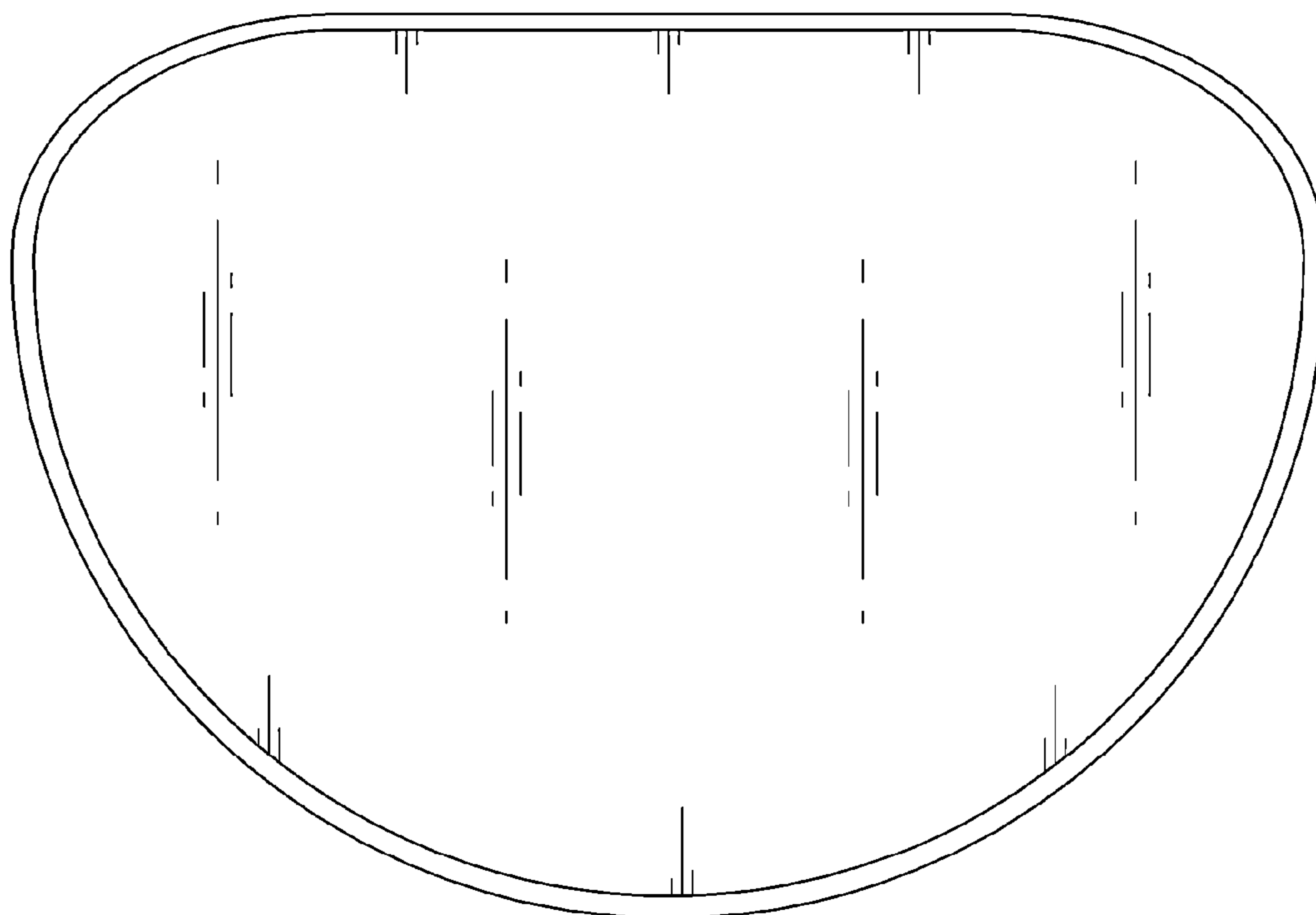

FIG. 7

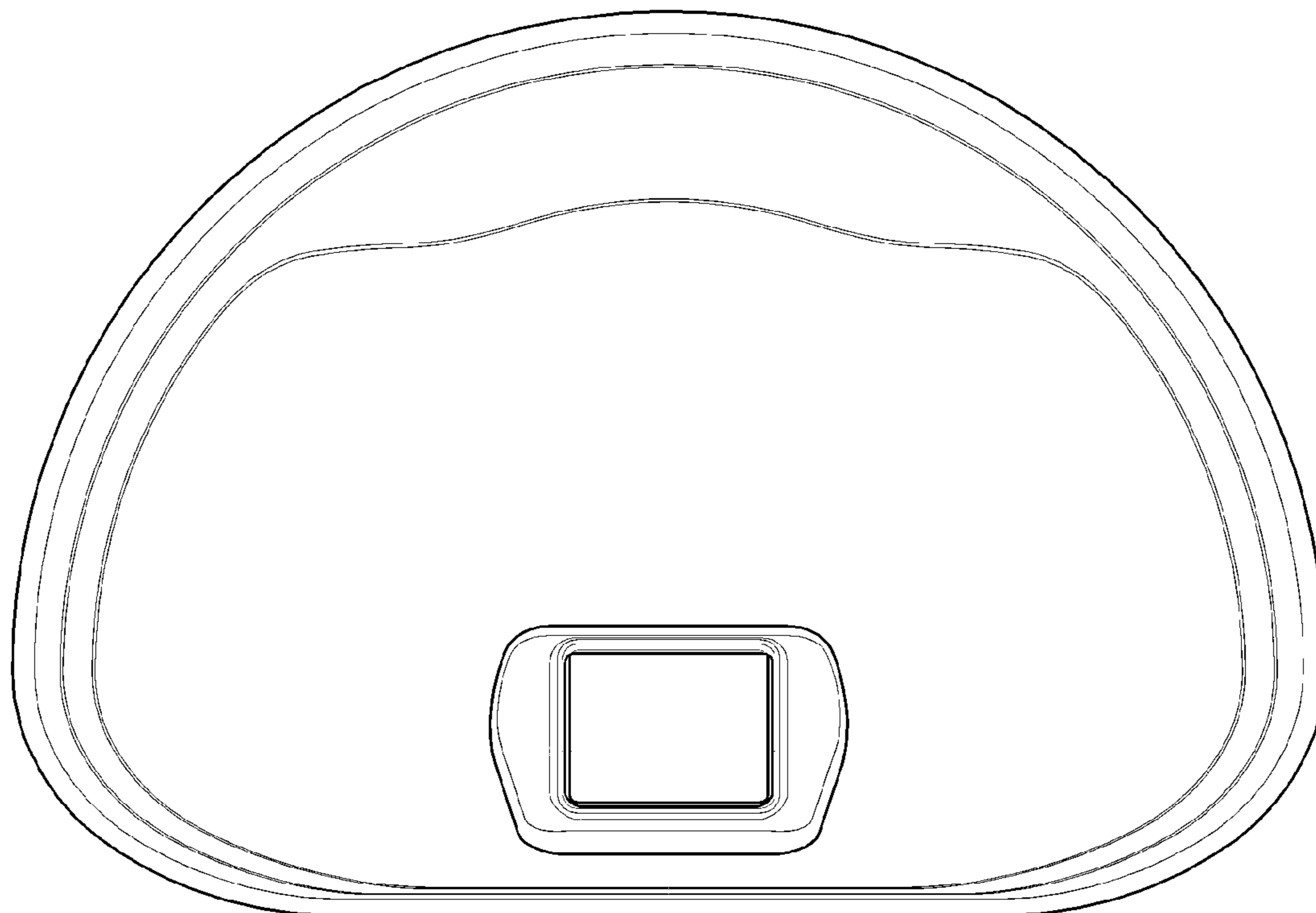

FIG. 8

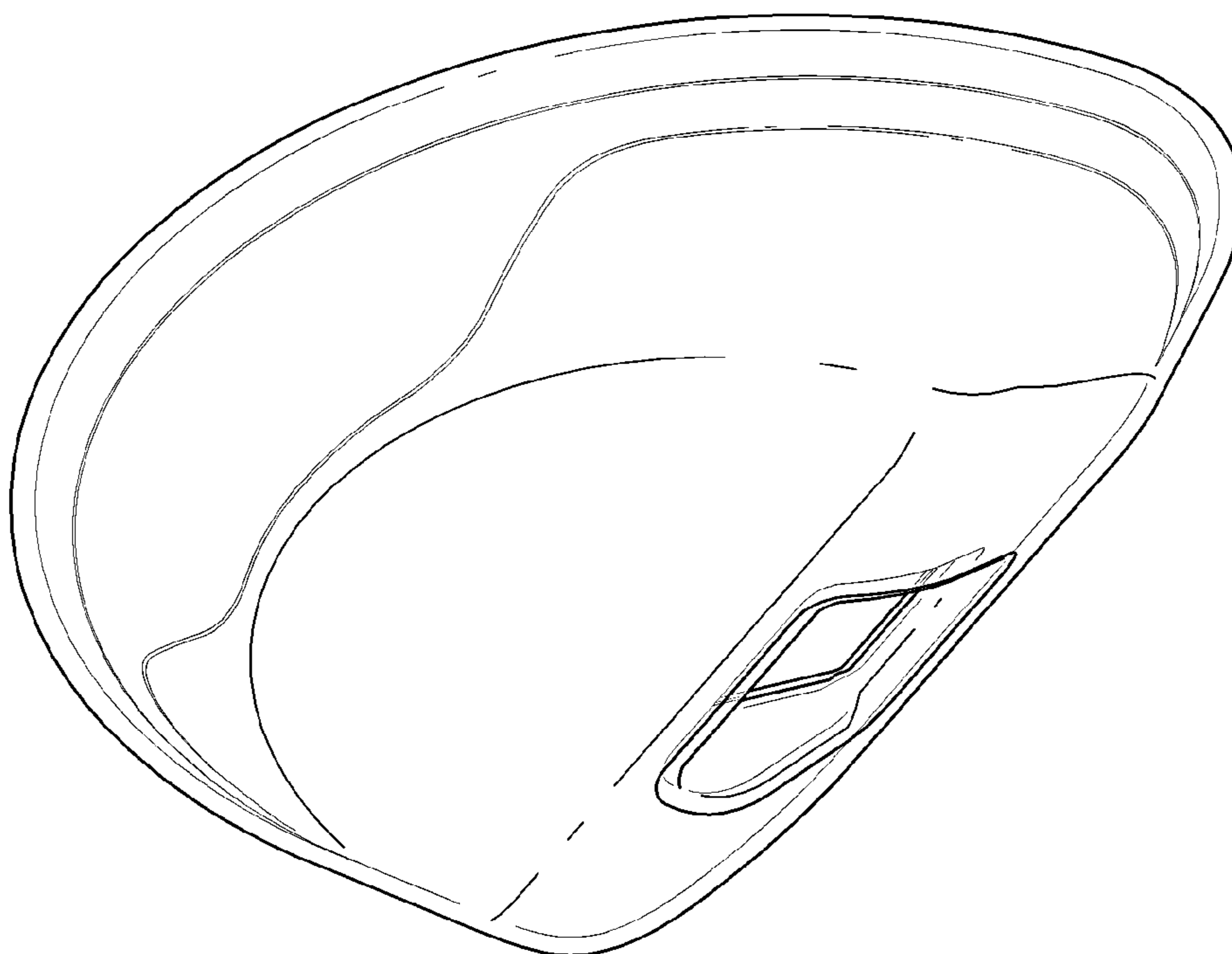

FIG. 9

