



US00D738799S

(12) **United States Design Patent**  
**Goeppel**

(10) **Patent No.:** **US D738,799 S**

(45) **Date of Patent:** **\*\* Sep. 15, 2015**

- (54) **FRONT BUMPER FOR A VEHICLE**
- (71) Applicant: **Bayerische Motoren Werke Aktiengesellschaft, Munich (DE)**
- (72) Inventor: **Stefan Goeppel, Munich (DE)**
- (73) Assignee: **Bayerische Motoren Werke Aktiengesellschaft, Munich (DE)**

(\*\*) Term: **14 Years**

(21) Appl. No.: **29/489,246**

(22) Filed: **Apr. 29, 2014**

(30) **Foreign Application Priority Data**

Oct. 31, 2013 (DE) ..... 40 2013 101 079

(51) **LOC (10) Cl.** ..... **12-16**

(52) **U.S. Cl.**  
USPC ..... **D12/169**

(58) **Field of Classification Search**  
USPC ..... D12/169, 216, 90-92, 86, 171, 196,  
D12/163; 293/102, 113, 115, 117, 120;  
296/180.1, 180.2  
CPC ..... B60R 19/02; B60R 19/04; B62D 25/08  
See application file for complete search history.

(56) **References Cited**

**U.S. PATENT DOCUMENTS**

- D534,104 S \* 12/2006 Miyata et al. .... D12/163
- D534,106 S \* 12/2006 Matei ..... D12/169
- D535,594 S \* 1/2007 Schiavone et al. .... D12/169
- D538,208 S \* 3/2007 Golden et al. .... D12/169
- D541,712 S \* 5/2007 Golden et al. .... D12/169

- D548,146 S \* 8/2007 Schiavone et al. .... D12/169
- D560,144 S \* 1/2008 Tant et al. .... D12/169
- D561,072 S \* 2/2008 Golden et al. .... D12/169
- D563,843 S \* 3/2008 Kido et al. .... D12/169
- D570,751 S \* 6/2008 Choi ..... D12/169
- D573,068 S \* 7/2008 Gresens et al. .... D12/169
- D711,295 S \* 8/2014 Mackay ..... D12/169
- D726,604 S \* 4/2015 Grake et al. .... D12/169

\* cited by examiner

*Primary Examiner* — Melody N Brown

(74) *Attorney, Agent, or Firm* — Crowell & Moring LLP

(57) **CLAIM**

The ornamental design for a front bumper for a vehicle, as shown and described.

**DESCRIPTION**

This application contains subject matter related to the following co-pending U.S. design patent applications: Application Ser. No. 29/489,250, filed herewith and entitled "Vehicle, Toy, and/or Replicas Thereof"; and Application Ser. No. 29/489,245, filed herewith and entitled "Front Bumper for a Vehicle".

FIG. 1 is a front view of a front bumper for a vehicle according to the design;

FIG. 2 is a right perspective view thereof;

FIG. 3 is a left perspective view thereof;

FIG. 4 is a right side view thereof;

FIG. 5 is a top view thereof;

FIG. 6 is a bottom view thereof; and,

FIG. 7 is a rear view thereof.

**1 Claim, 7 Drawing Sheets**

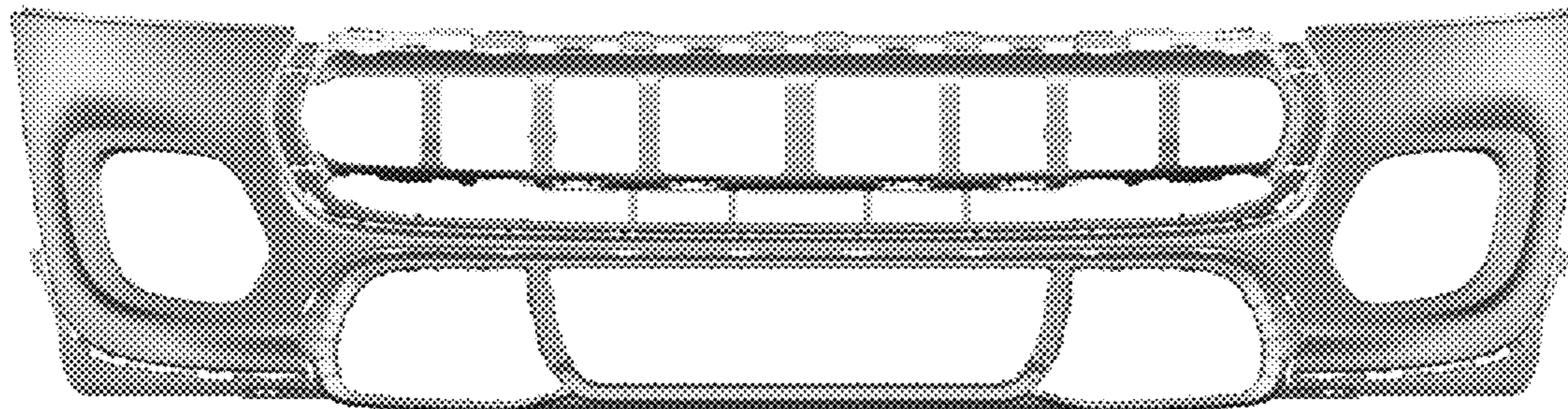

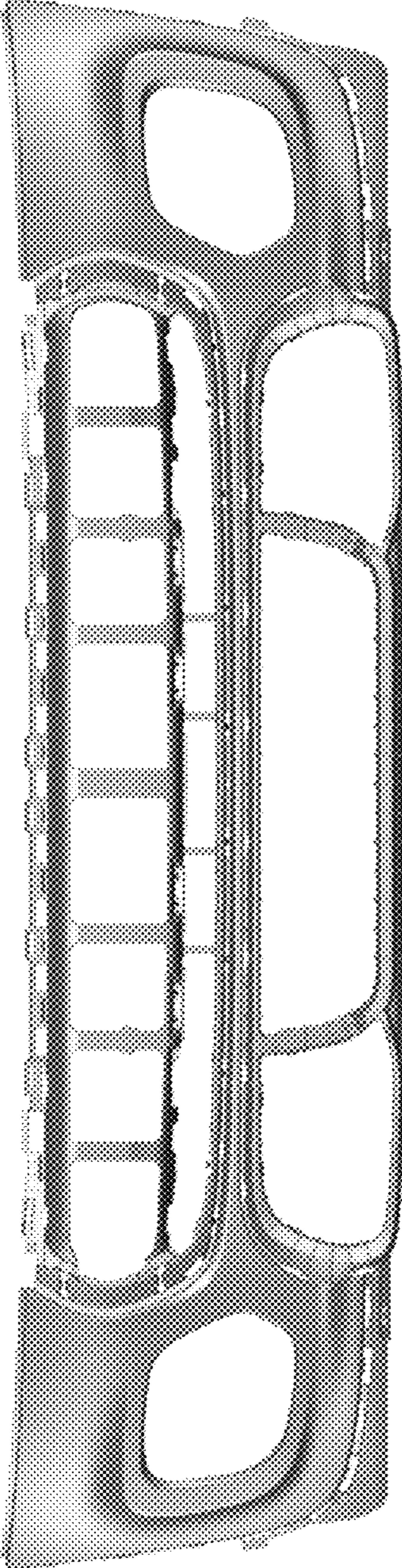

Fig. 1

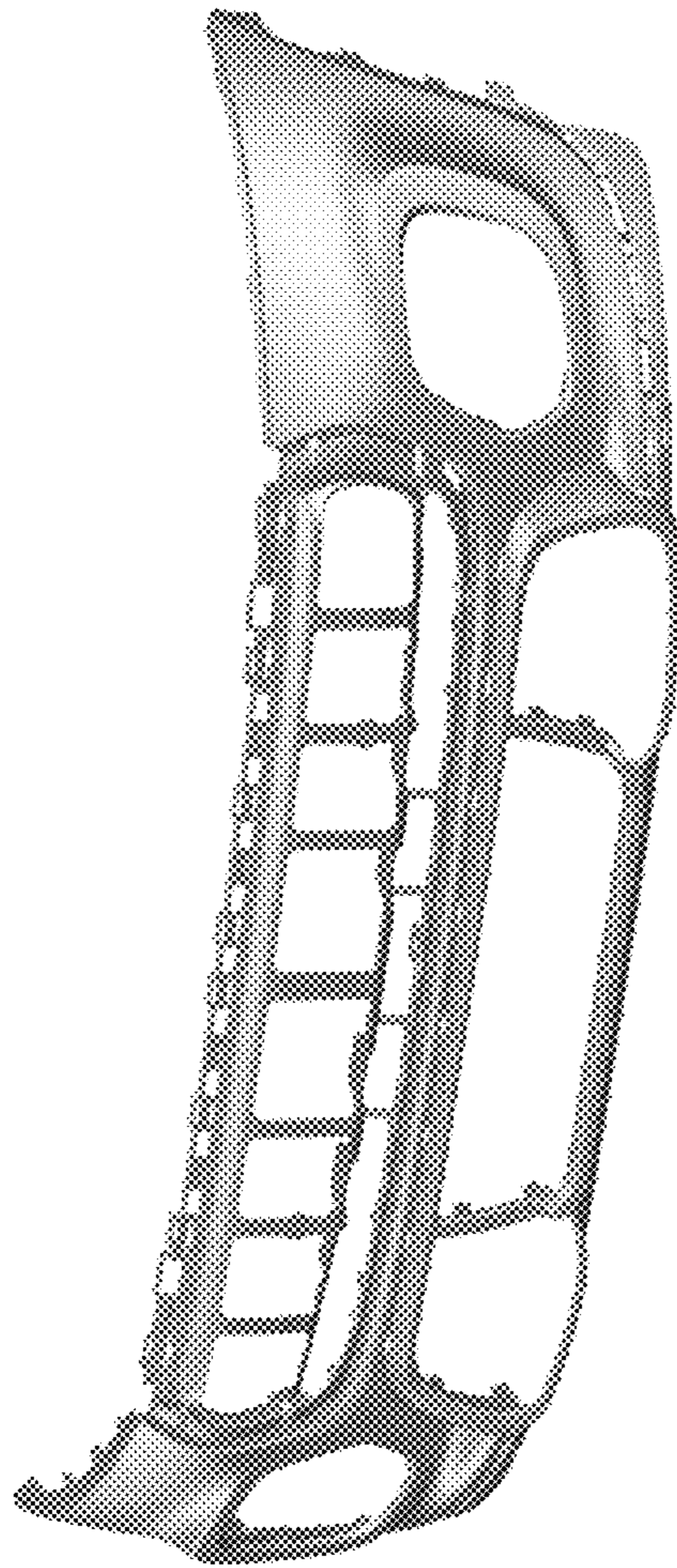

Fig. 2

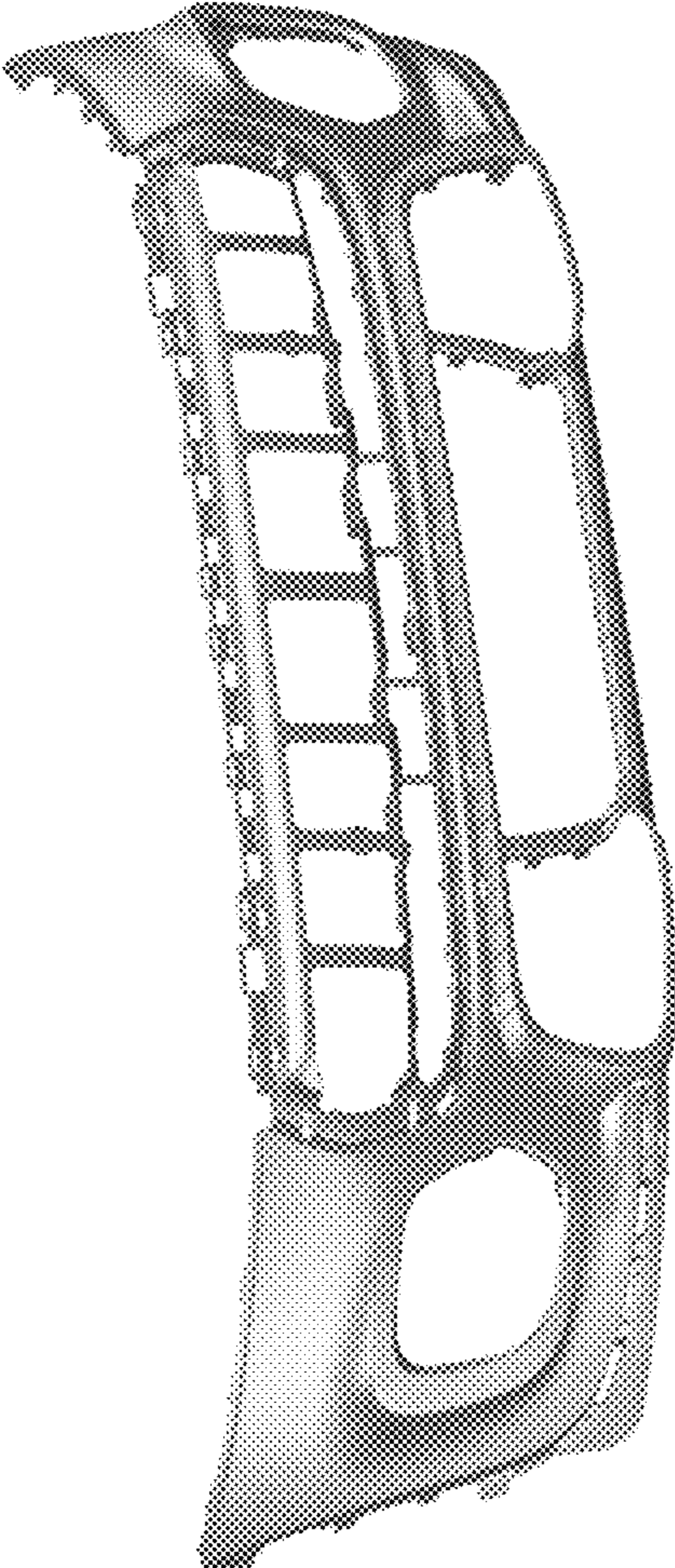

Fig. 3

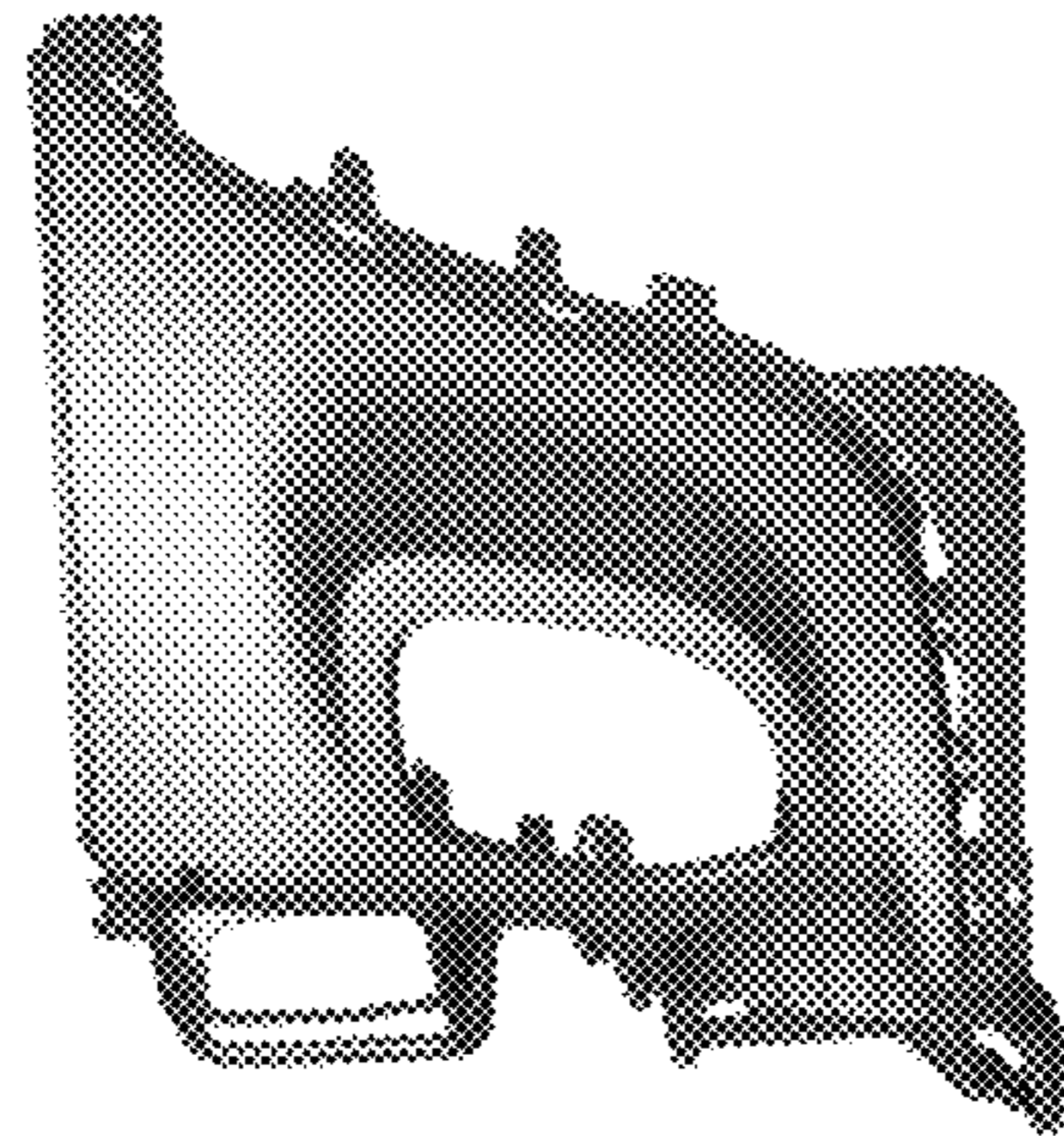

Fig. 4

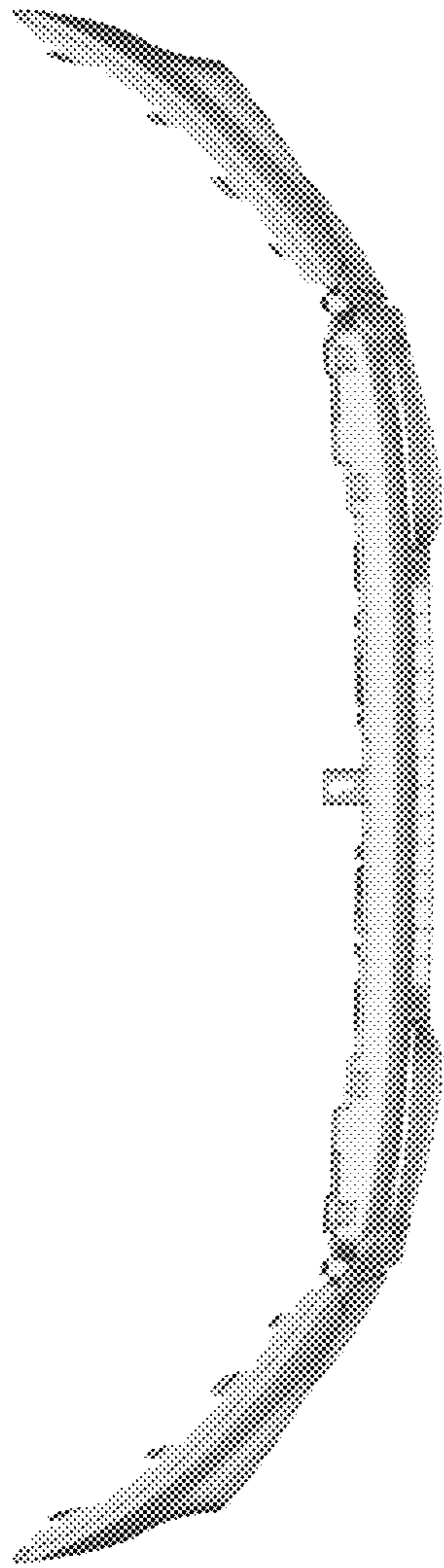

Fig. 5

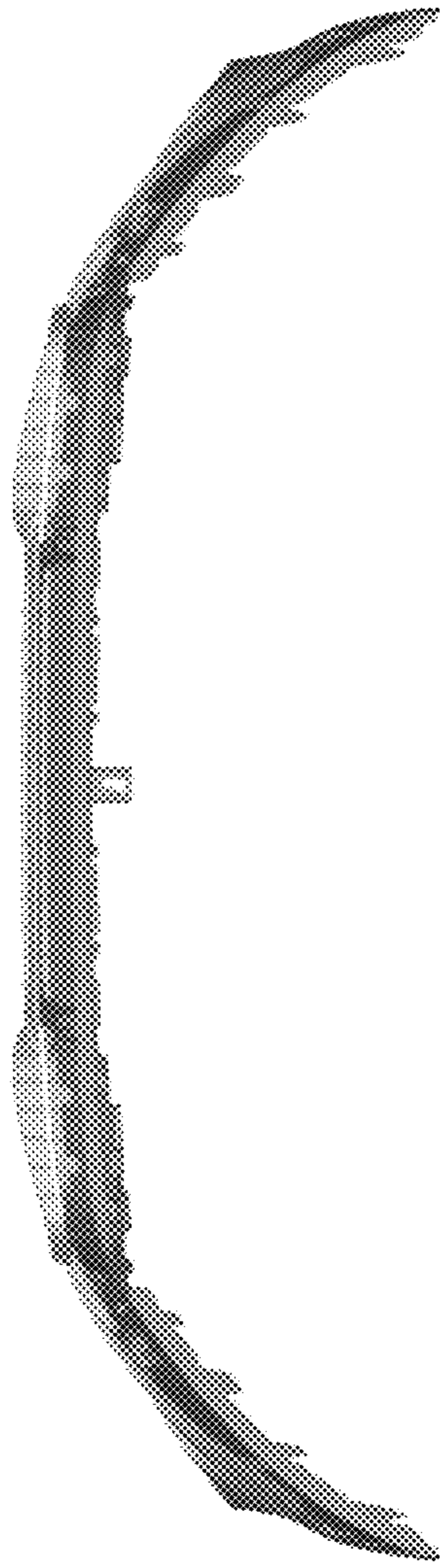

Fig. 6

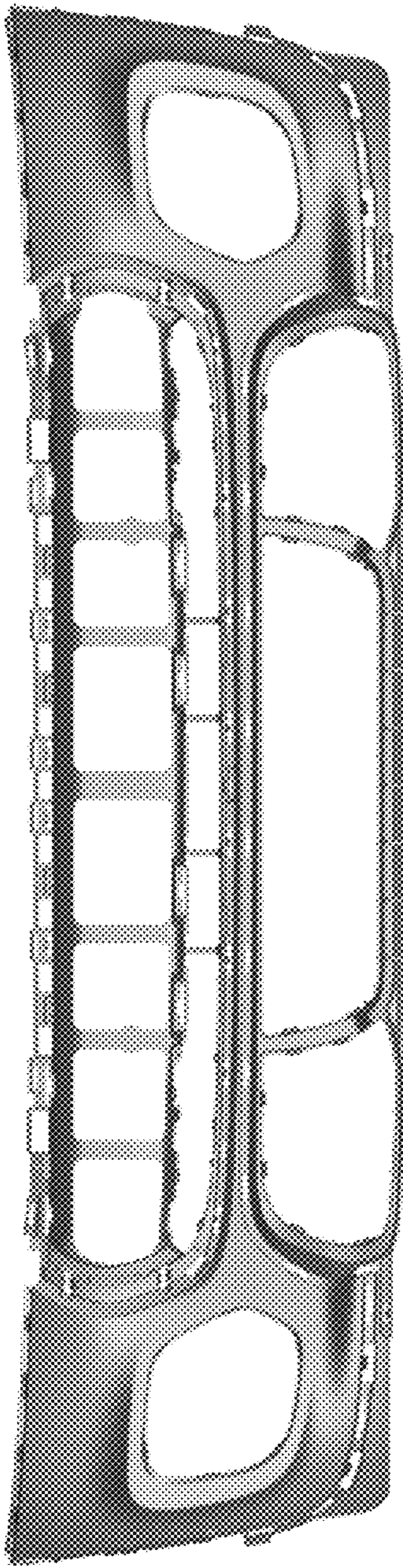

Fig. 7