



US00D738793S

(12) **United States Design Patent**
Brewer et al.

(10) **Patent No.:** **US D738,793 S**

(45) **Date of Patent:** **** Sep. 15, 2015**

(54) **TRICYCLE**

(71) Applicant: **ARUANÃ ENERGIA S/A**, Goiânia (BR)

(72) Inventors: **Brian Brewer**, Goiânia (BR); **Robert James McKinnon**, Goiânia (BR)

(**) Term: **14 Years**

(21) Appl. No.: **29/471,811**

(22) Filed: **Nov. 5, 2013**

(30) **Foreign Application Priority Data**

Jun. 20, 2013 (BR) 30 2013 002917 4

(51) **LOC (10) Cl.** **12-11**

(52) **U.S. Cl.**
USPC **D12/112**

(58) **Field of Classification Search**
USPC D12/111; 280/261, 252, 220, 221, 256, 280/232, 259, 254, 257, 253, 62, 63, 87.05, 280/270, 265, 288.1; 482/51, 57, 52; 74/143, 25, 37; 180/24.11, 206.1, 180/206.5, 210; D21/423
See application file for complete search history.

(56) **References Cited**

U.S. PATENT DOCUMENTS

1,977,035	A *	10/1934	Benjamin	280/221
2,076,804	A *	4/1937	Winding	280/221
2,148,919	A *	2/1939	Winding	280/221
5,110,148	A *	5/1992	Stienbarger et al.	280/221
6,334,838	B1 *	1/2002	Lee	482/51
6,439,590	B1 *	8/2002	Liang	280/221
6,659,486	B2 *	12/2003	Eschenbach	280/221
6,764,088	B2 *	7/2004	Hung	280/221
D526,250	S *	8/2006	Trumble et al.	D12/111
D638,482	S *	5/2011	Scolari et al.	D21/423
D638,483	S *	5/2011	Scolari et al.	D21/423
D638,484	S *	5/2011	Scolari et al.	D21/423
D638,498	S *	5/2011	Scolari et al.	D21/423
D638,499	S *	5/2011	Scolari et al.	D21/423
D638,500	S *	5/2011	Scolari et al.	D21/423

D645,792	S *	9/2011	Bai	D12/111
8,128,111	B2 *	3/2012	Scolari et al.	280/221
8,220,814	B1 *	7/2012	Riviglia et al.	280/252
D688,164	S *	8/2013	Calderon	D12/111
8,579,769	B2 *	11/2013	Sans	482/52
2009/0315294	A1 *	12/2009	Conti	280/221
2010/0244399	A1 *	9/2010	Teal et al.	280/221
2010/0320718	A1 *	12/2010	Buchberger	280/221
2011/0285105	A1 *	11/2011	Chen	280/220
2014/0243157	A1 *	8/2014	Huang et al.	482/52
2014/0265218	A1 *	9/2014	Scolari	280/261

* cited by examiner

Primary Examiner — Robert M Spear

Assistant Examiner — Ryan Harvey

(74) *Attorney, Agent, or Firm* — Pillsbury Winthrop Shaw Pittman LLP

(57) **CLAIM**

The ornamental design for a tricycle, as shown and described.

DESCRIPTION

FIG. 1 is a perspective view of an embodiment of the design for a tricycle;

FIG. 2 is a lateral/side elevation view of the embodiment of the design of FIG. 1;

FIG. 3 is lateral/side elevation view of the embodiment of the design of FIG. 1 on the opposite side of the side depicted in FIG. 2;

FIG. 4 is a front elevation view of the embodiment of the design of FIG. 1;

FIG. 5 is a rear elevation view of the embodiment of the design of FIG. 1;

FIG. 6 is a bottom plan view of the embodiment of the design of FIG. 1; and,

FIG. 7 is a top plan view of the embodiment of the design of FIG. 1.

The tricycle, e.g., an elliptical tricycle, is for, e.g., transportation, leisure and/or physical activity.

Any components or portions in the accompanying drawings shown in broken lines form no part of the claimed design or a specified embodiment thereof.

1 Claim, 7 Drawing Sheets

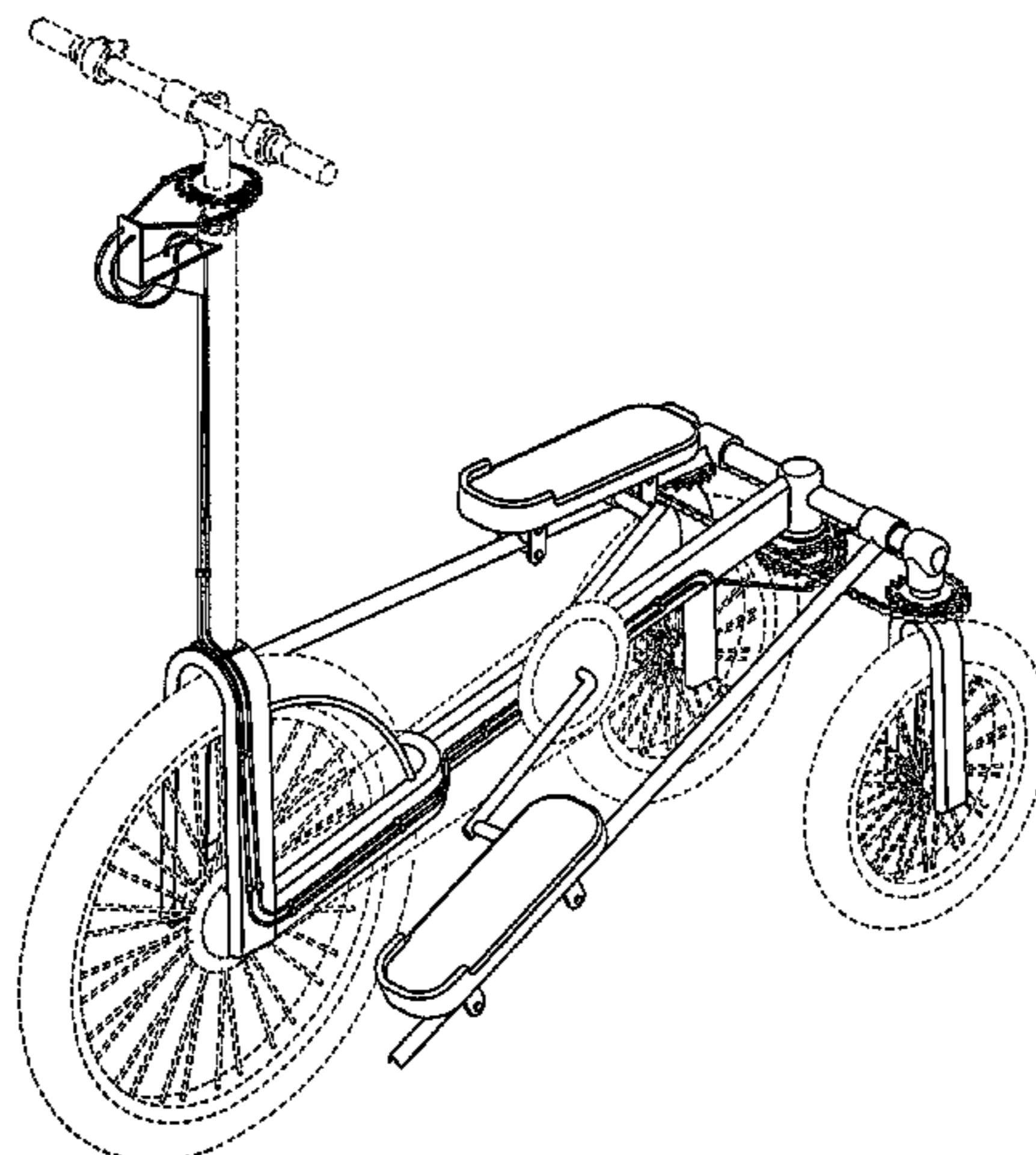

FIG.1

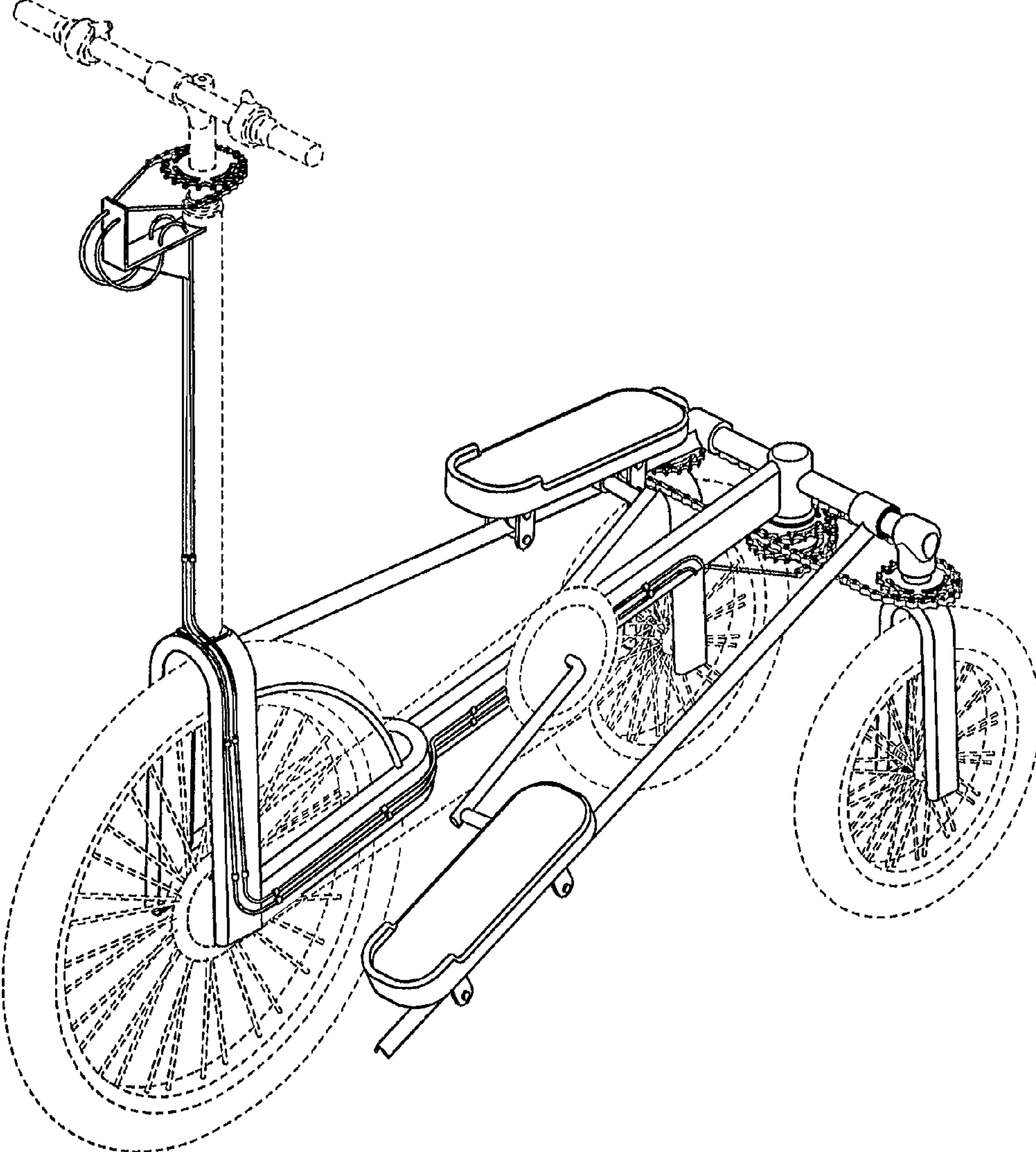

FIG.2

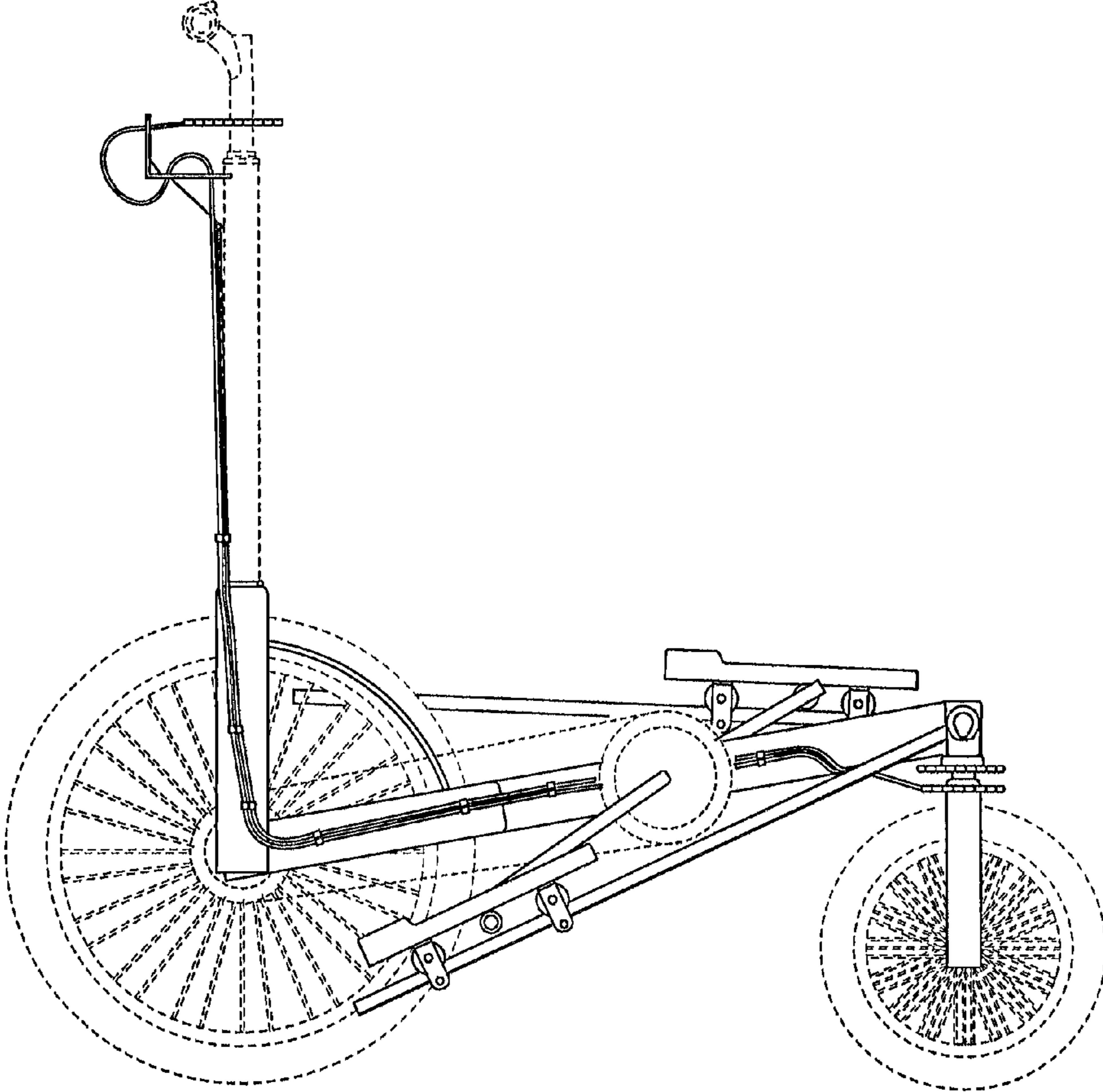

FIG.3

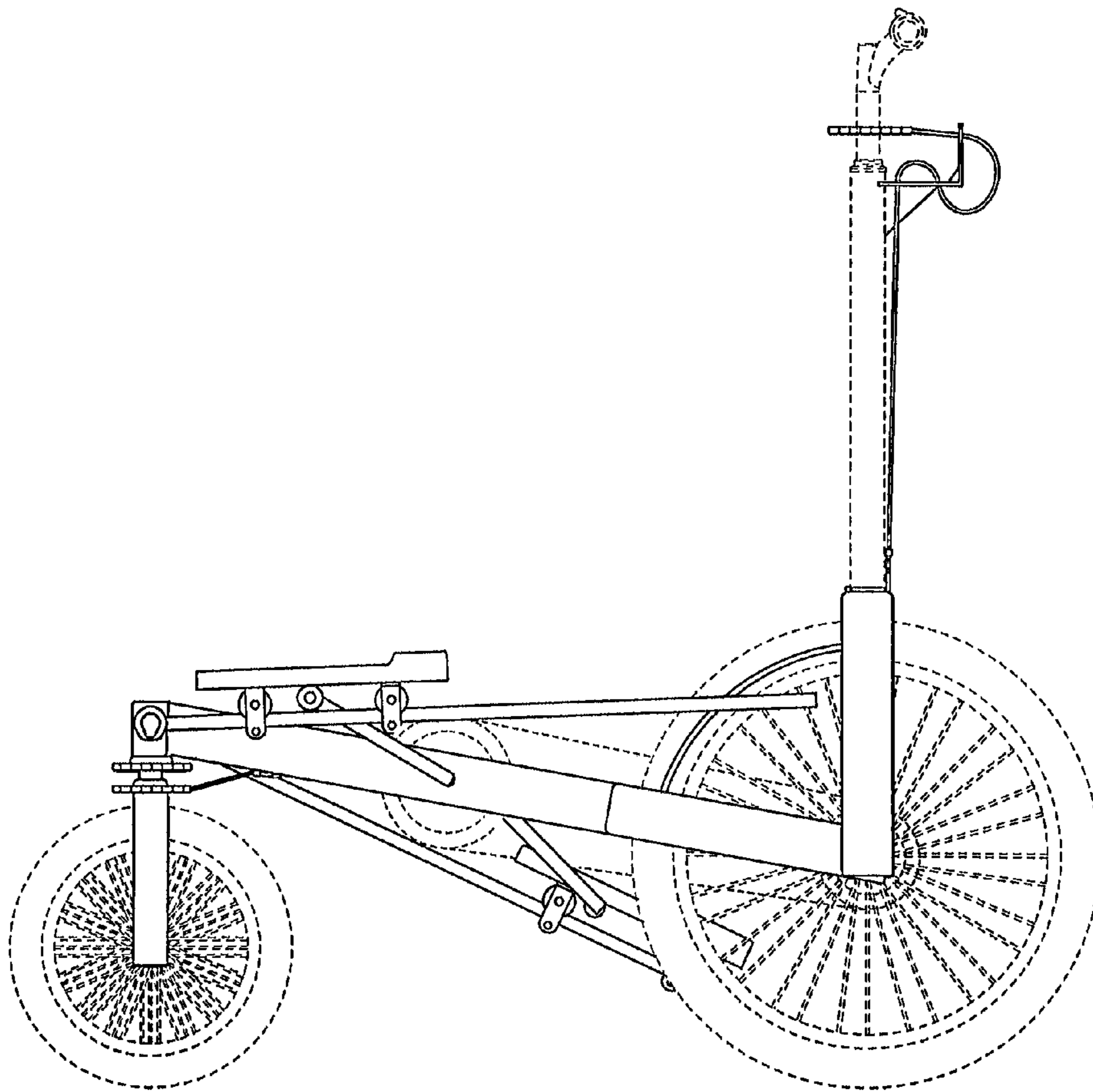

FIG.4

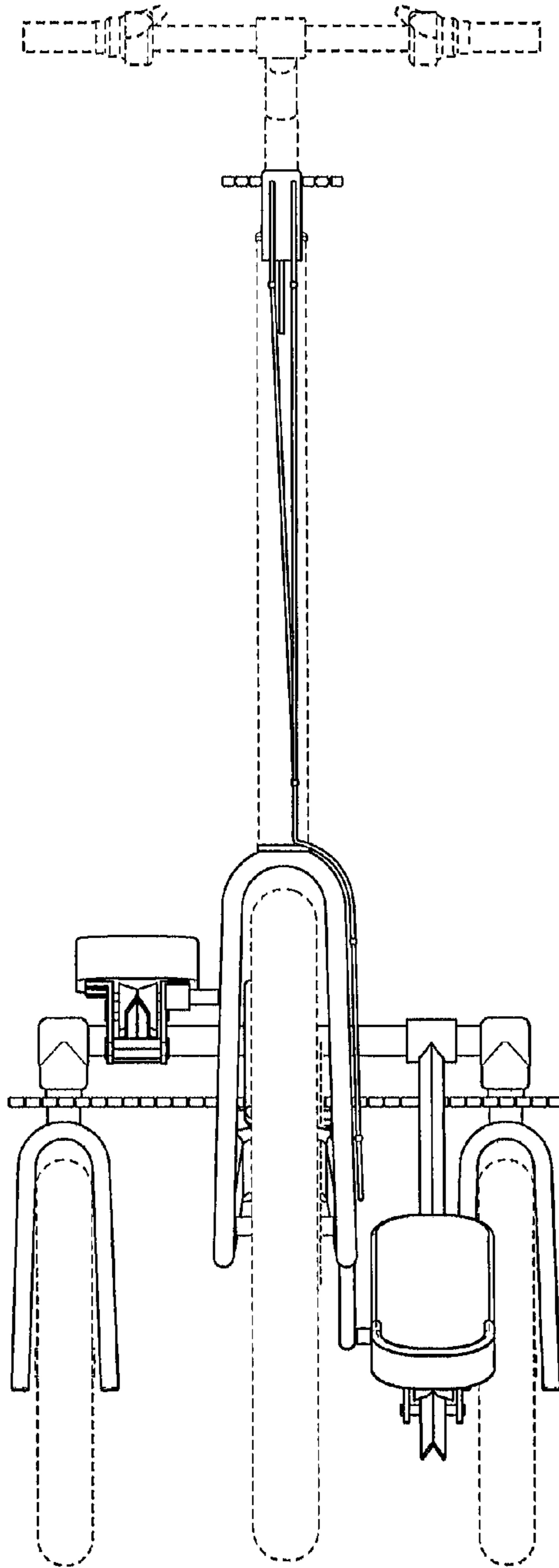

FIG.5

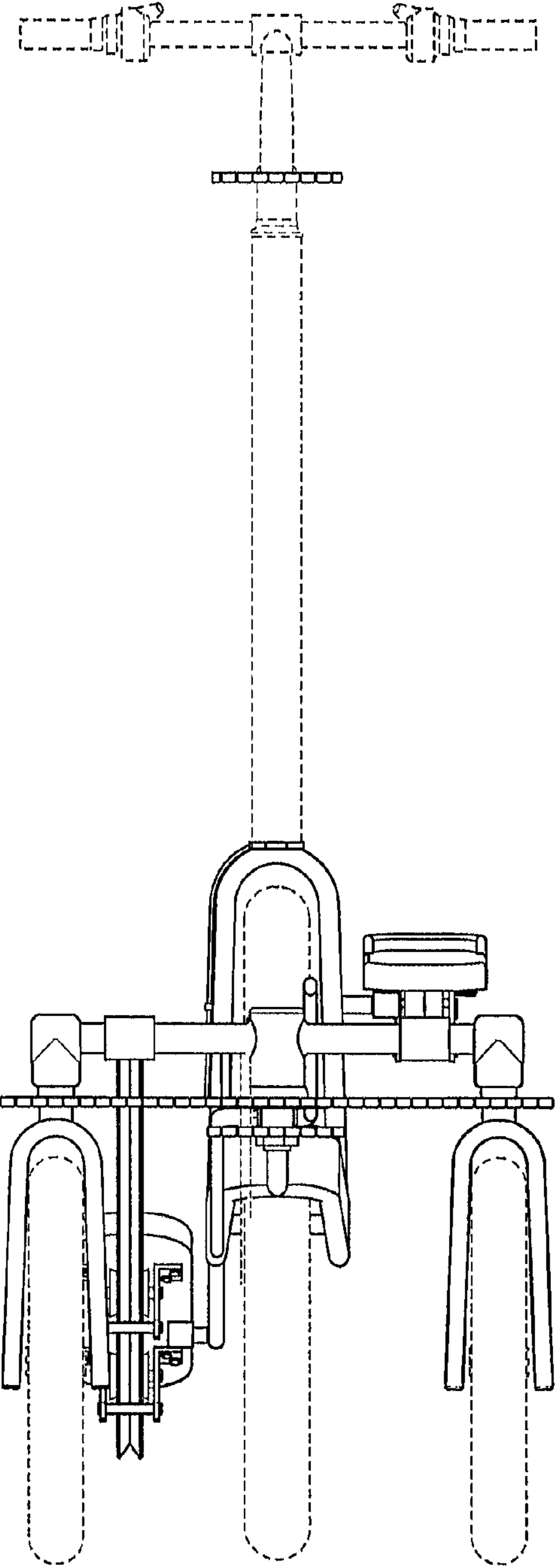

FIG.6

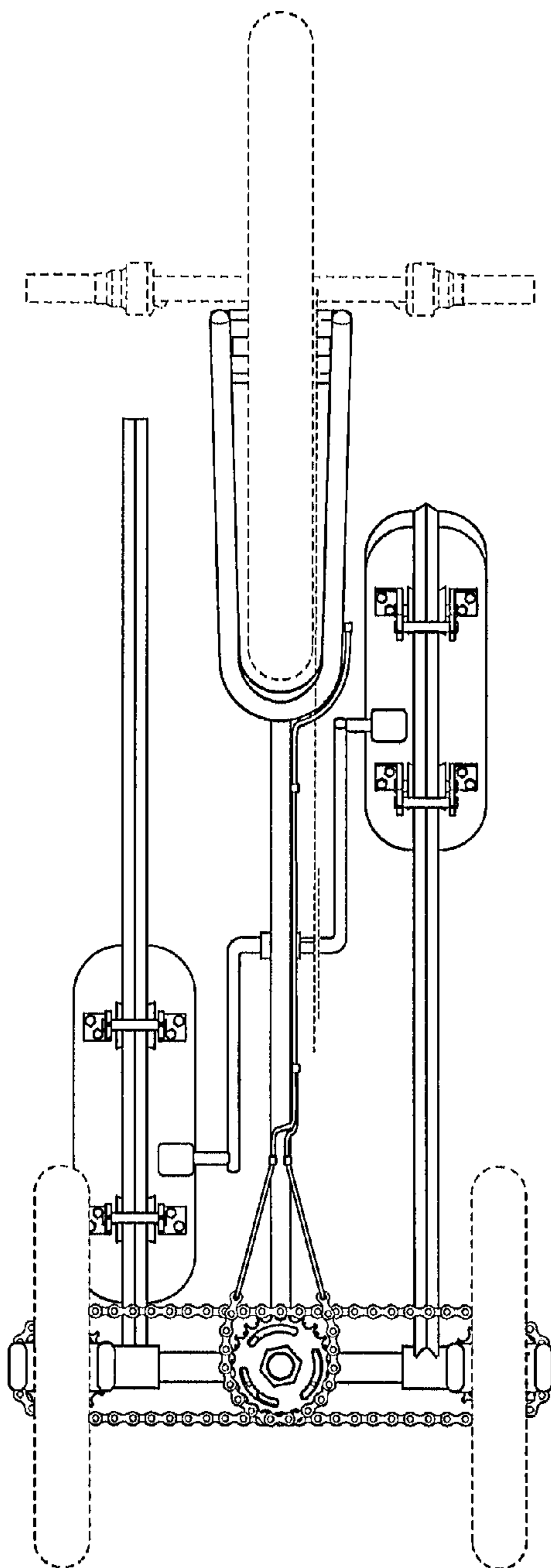

FIG.7

