



US00D738680S

(12) **United States Design Patent**  
**Renforth et al.**

(10) **Patent No.:** **US D738,680 S**  
(45) **Date of Patent:** **\*\* Sep. 15, 2015**

(54) **FOOD BOWL PORTION WITH SUPPORT**  
(71) Applicant: **DOSKOCIL MANUFACTURING COMPANY, INC.**, Arlington, TX (US)  
(72) Inventors: **Jack W. Renforth**, Azle, TX (US);  
**Norman Anderson**, Brooklyn, NY (US)  
(\*\*) Term: **14 Years**  
(21) Appl. No.: **29/489,000**

D88,946 S \* 1/1933 Worthington ..... D7/556  
D164,659 S \* 9/1951 Yecko et al. .... D7/564  
D167,269 S \* 7/1952 Mandelko ..... D7/551.3  
D174,686 S \* 5/1955 Gangbin ..... D7/556  
D189,082 S \* 10/1960 Goodman ..... D2/899  
D227,139 S \* 6/1973 Niven ..... D7/551.3  
D303,441 S \* 9/1989 Keller ..... D30/129  
D358,008 S \* 5/1995 Keller et al. .... D30/161  
D358,738 S \* 5/1995 Brown et al. .... D7/544  
D358,739 S \* 5/1995 Brown et al. .... D7/544  
D370,146 S \* 5/1996 Petronio ..... D6/534

(Continued)

(22) Filed: **Apr. 25, 2014**  
(51) **LOC (10) Cl.** ..... **31-00**  
(52) **U.S. Cl.**  
USPC ..... **D7/396.6; D7/403; D7/552.2; D7/551.3;**  
**D7/516; D7/559; D30/129**  
(58) **Field of Classification Search**  
USPC ..... **D7/396.1, 396.2, 396.5, 396.6, 387,**  
**D7/388, 389, 392.1, 399, 393, 396, 403,**  
**D7/550.1, 551.1, 552.2, 558, 559, 571,**  
**D7/213, 560, 553.6, 505, 500, 507, 541,**  
**D7/542, 553.2, 554.3, 514-520, 539, 544,**  
**D7/551.3, 564, 569, 573, 578, 594, 595,**  
**D7/619.2, 675, 689; D30/129, 101, 102,**  
**D30/103, 128, 133, 141, 146, 148, 199;**  
**D6/365, 372, 310, 311, 688.17, 688.19,**  
**D6/654.14, 691.4, 696.1, 708, 708.1,**  
**D6/708.11, 708.15, 708.22, 708.25, 709,**  
**D6/709.11, 709.17, 710; D21/417;**  
**220/592.15, 495.03; D23/221, 280.4,**  
**D23/278, 304, 277, 303; D26/138, 142;**  
**D9/548; 215/227, 395, 374, 376, 377;**  
**D11/152, 143**  
CPC .... **B65D 23/001; B65D 75/008; A47G 19/00;**  
**A47G 21/00**  
See application file for complete search history.

**OTHER PUBLICATIONS**

<http://dog-milk.com/four-pawed-pet-bowls-by-dylan-kendall/> Four-Pawed Pet Bowls by Dylan Kendall on Jul. 12, 2013.\*

*Primary Examiner* — Marianne Pandozzi  
*Assistant Examiner* — Jae Liang  
(74) *Attorney, Agent, or Firm* — Global IP Counselors, LLP

(57) **CLAIM**  
The ornamental design for a food bowl portion with support, as shown and described.

**DESCRIPTION**

FIG. 1 is a top perspective view of a food bowl portion with support showing our new design;  
FIG. 2 is a lower perspective view thereof;  
FIG. 3 is a front elevational view thereof;  
FIG. 4 is a right side elevational view thereof;  
FIG. 5 is a left side elevational view thereof;  
FIG. 6 is a rear elevational view thereof;  
FIG. 7 is a top plan view thereof; and,  
FIG. 8 is a bottom plan view thereof.  
The dashed lines depicted in FIGS. 1-5 and 7-8 are for illustration of environmental subject matter only and form no part of the claimed design. The dot-dash lines shown in FIGS. 1-8 are for illustration of the boundary between claimed subject matter and unclaimed subject matter only and form no part of the claimed design.

(56) **References Cited**  
**U.S. PATENT DOCUMENTS**  
D8,387 S \* 6/1875 Leighton, Jr. .... D7/564  
D81,749 S \* 8/1930 Kandel ..... D6/480

**1 Claim, 8 Drawing Sheets**

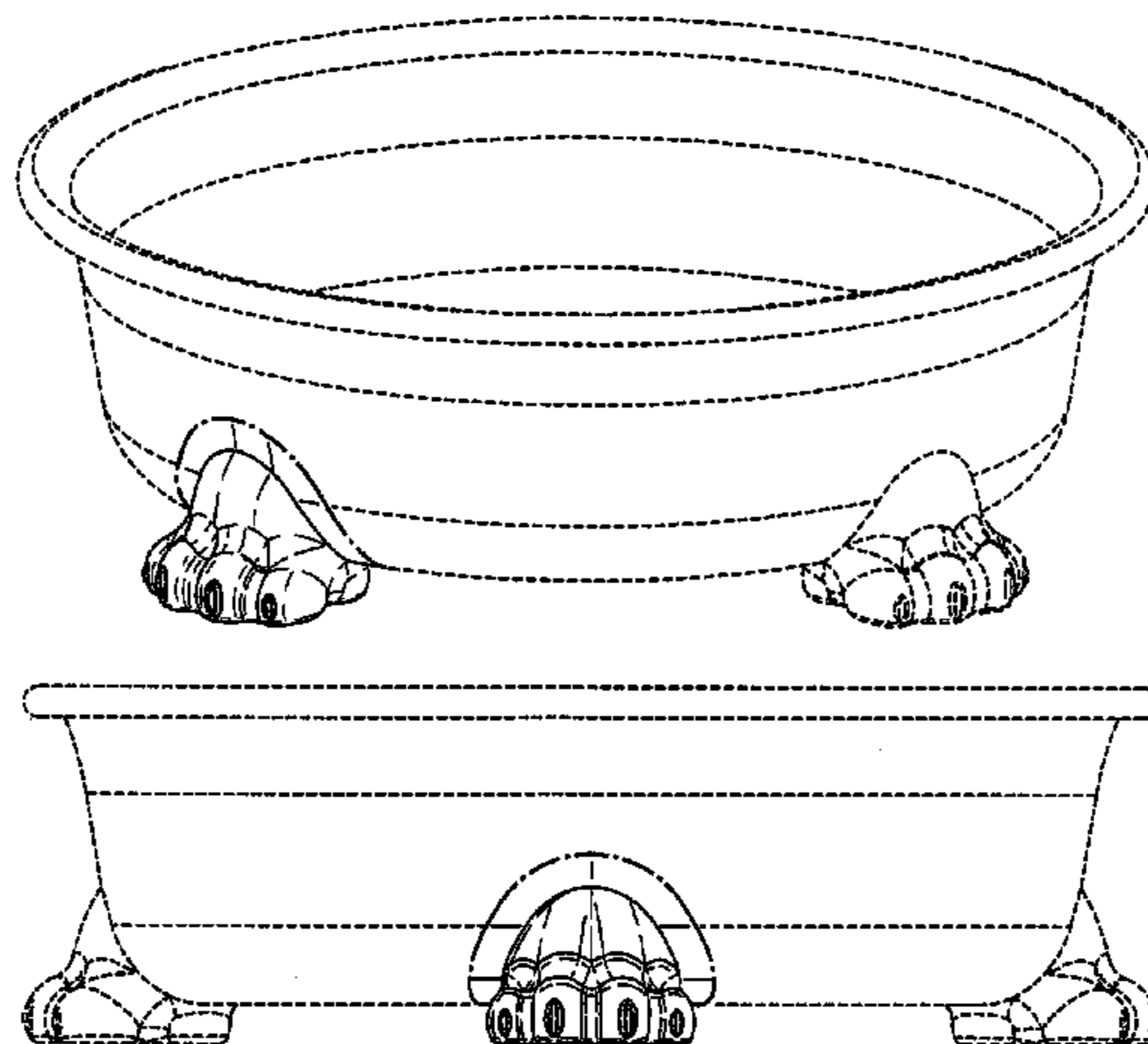

(56)

**References Cited**

U.S. PATENT DOCUMENTS

D370,147 S \* 5/1996 Petronio ..... D6/534  
D378,869 S \* 4/1997 Mikell ..... D2/615  
D436,002 S \* 1/2001 Shih ..... D7/396.6  
D454,234 S \* 3/2002 Weterrings ..... D30/129  
D455,579 S \* 4/2002 Vaaler ..... D6/688.17  
D527,916 S \* 9/2006 O'Hare ..... D6/310  
D554,432 S \* 11/2007 Roth et al. .... D7/516

D579,711 S \* 11/2008 Vendl et al. .... D7/354  
D590,109 S \* 4/2009 Anderson et al. .... D30/129  
D599,553 S \* 9/2009 Shapiro ..... D3/318  
D600,449 S \* 9/2009 Shapiro ..... D3/318  
D610,837 S \* 3/2010 Schmitt ..... D6/688.17  
D626,378 S \* 11/2010 Gonzalez ..... D7/516  
D626,786 S \* 11/2010 Gonzalez ..... D7/516  
D627,197 S \* 11/2010 Gonzalez ..... D7/516  
D640,354 S \* 6/2011 Goncalves et al. .... D23/280.4

\* cited by examiner

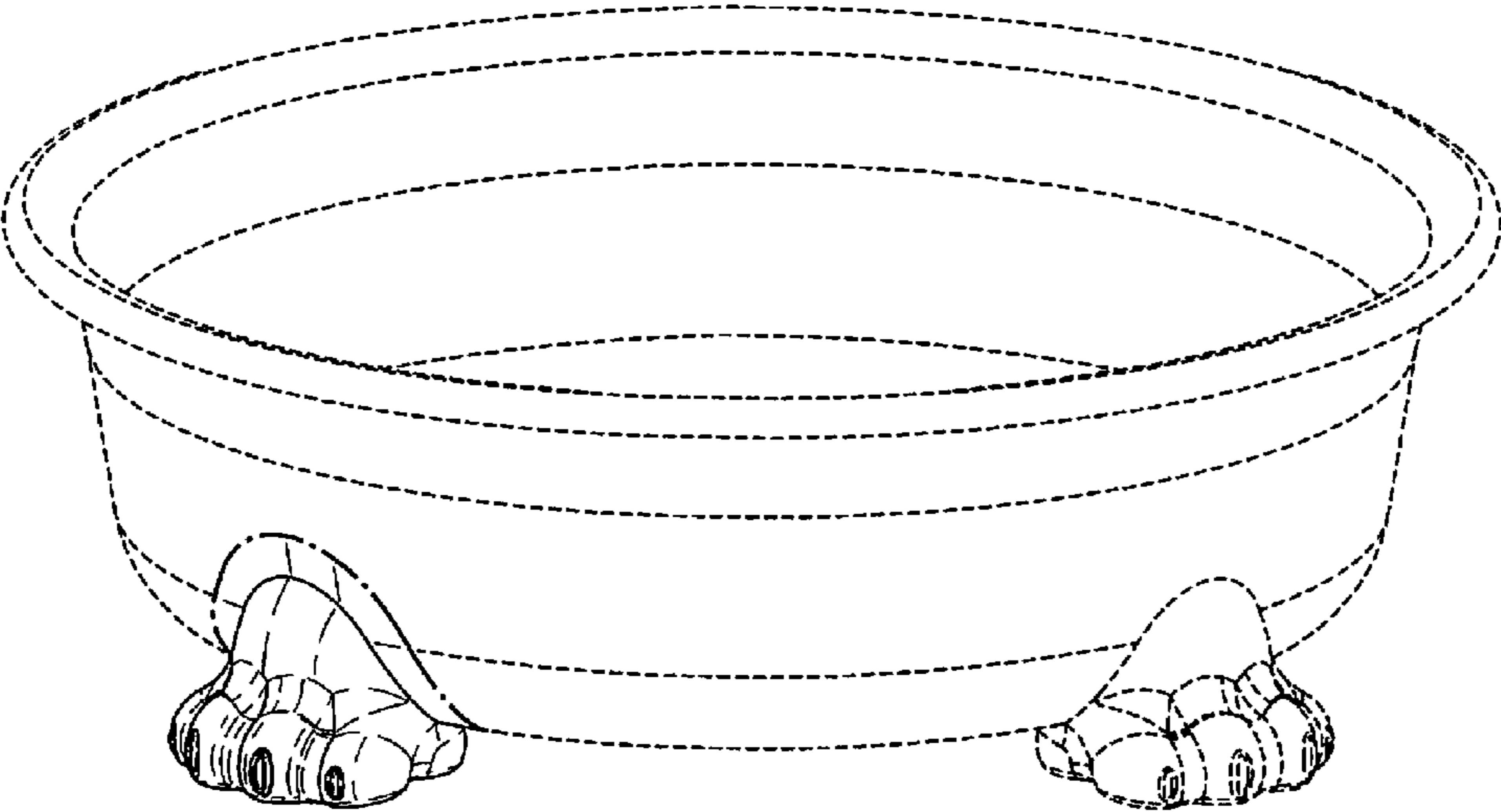

FIG.1

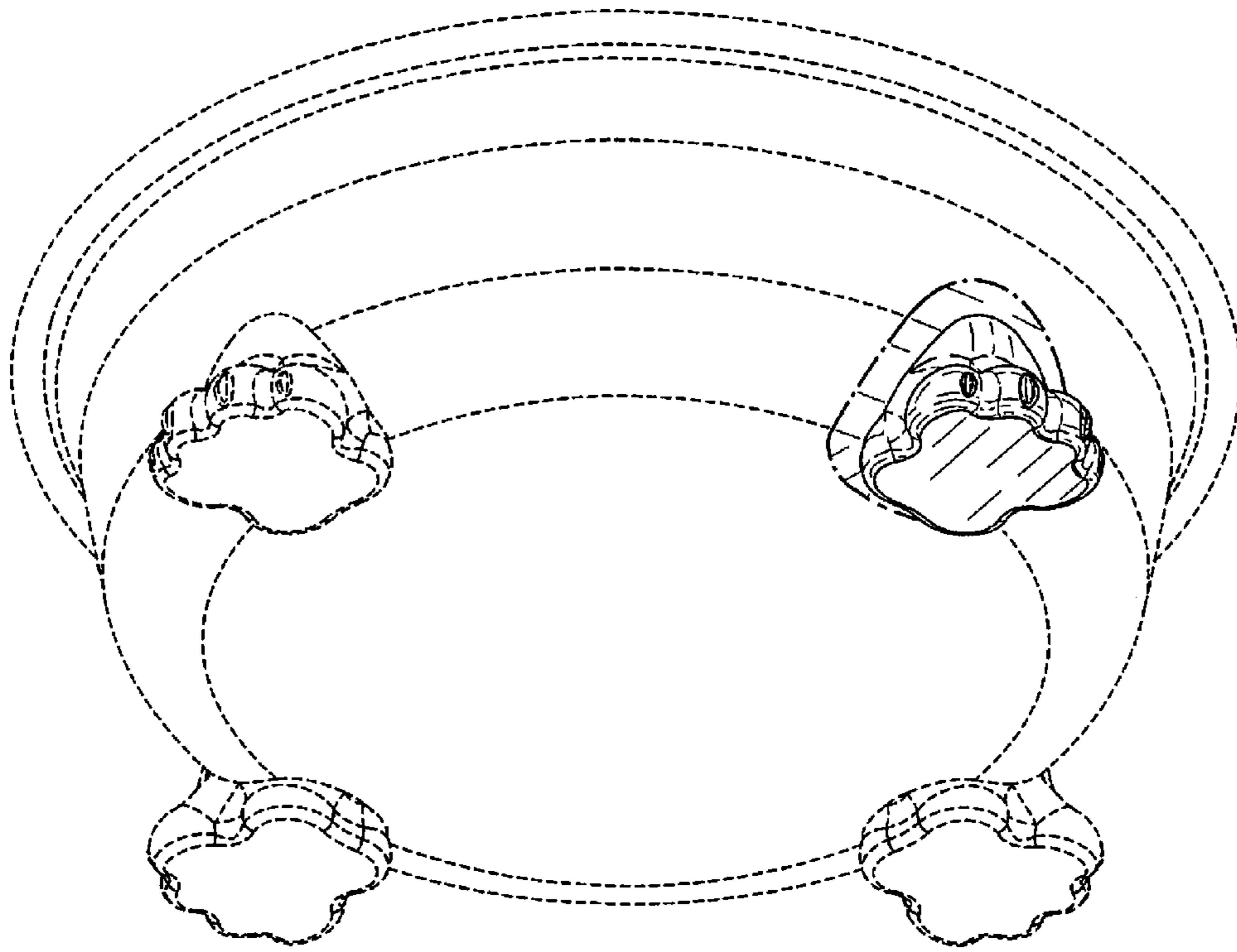
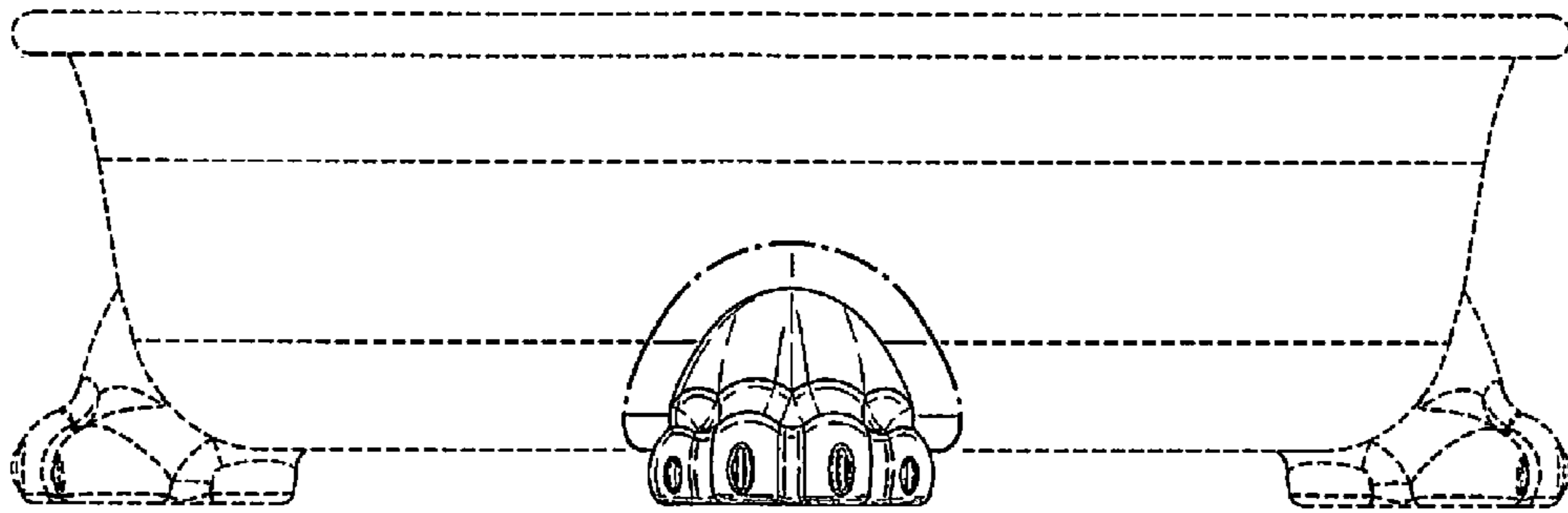

FIG. 2



*FIG. 3*

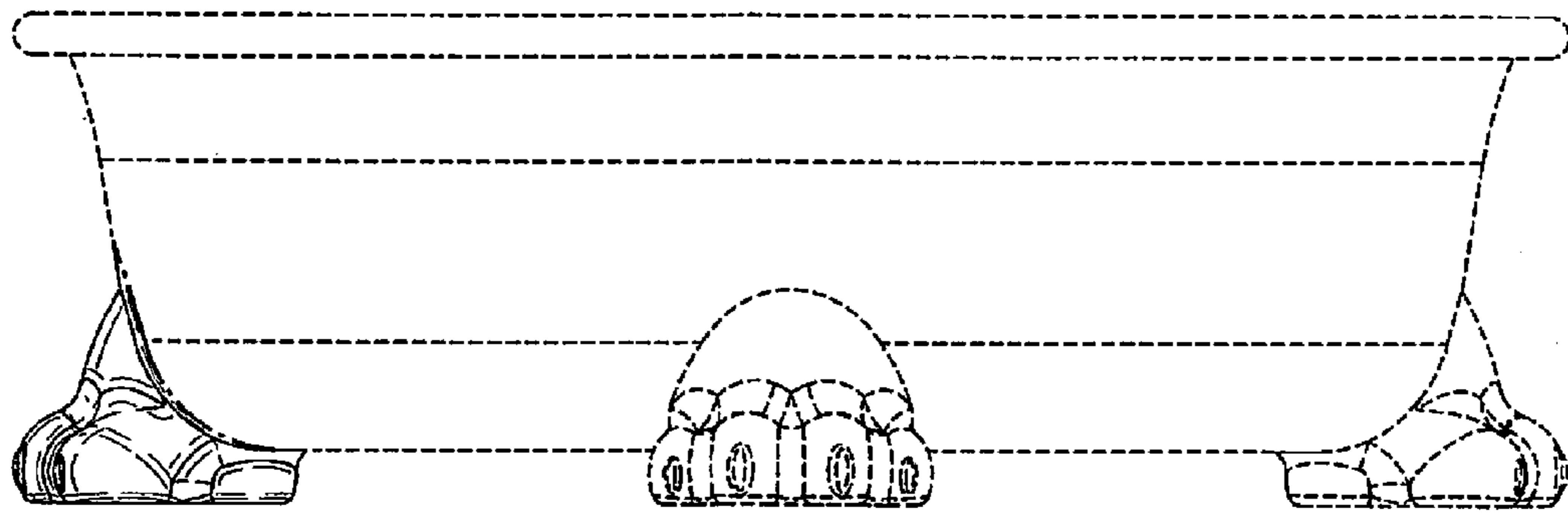

FIG. 4

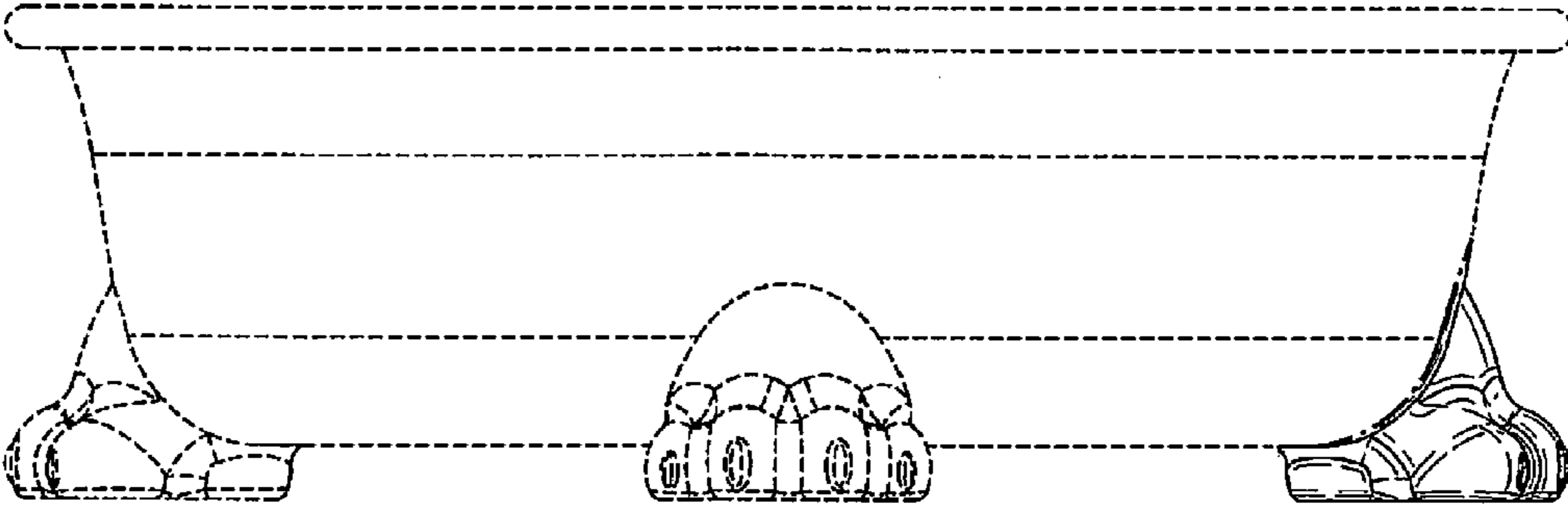
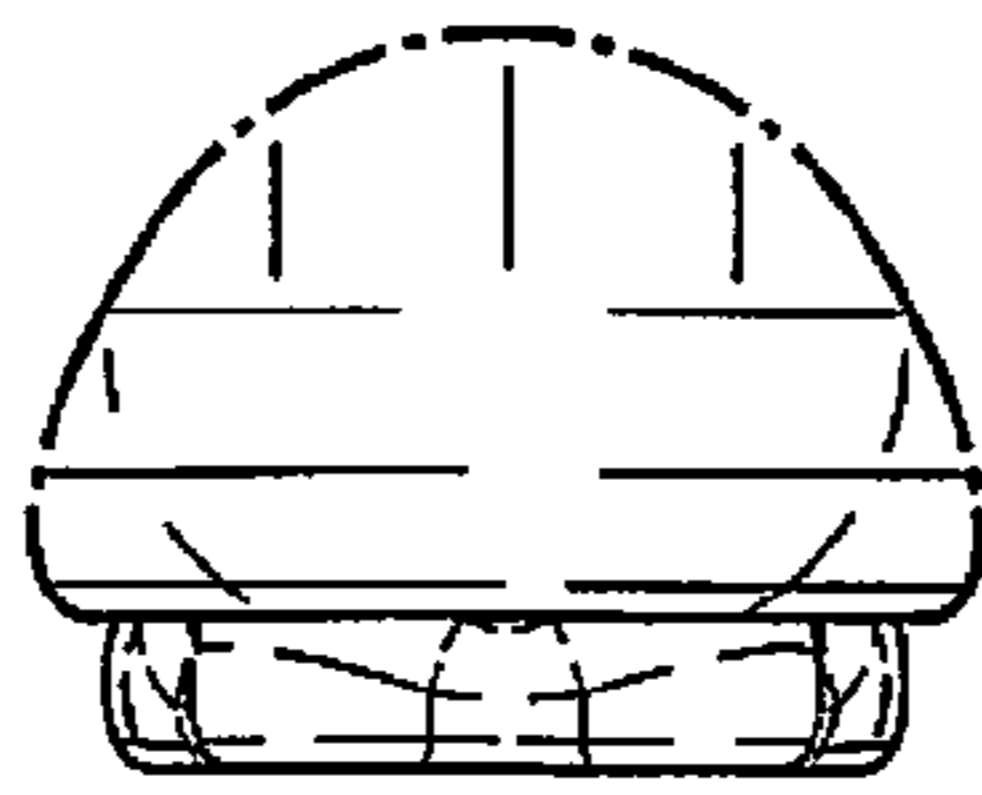

FIG. 5





*FIG. 6*



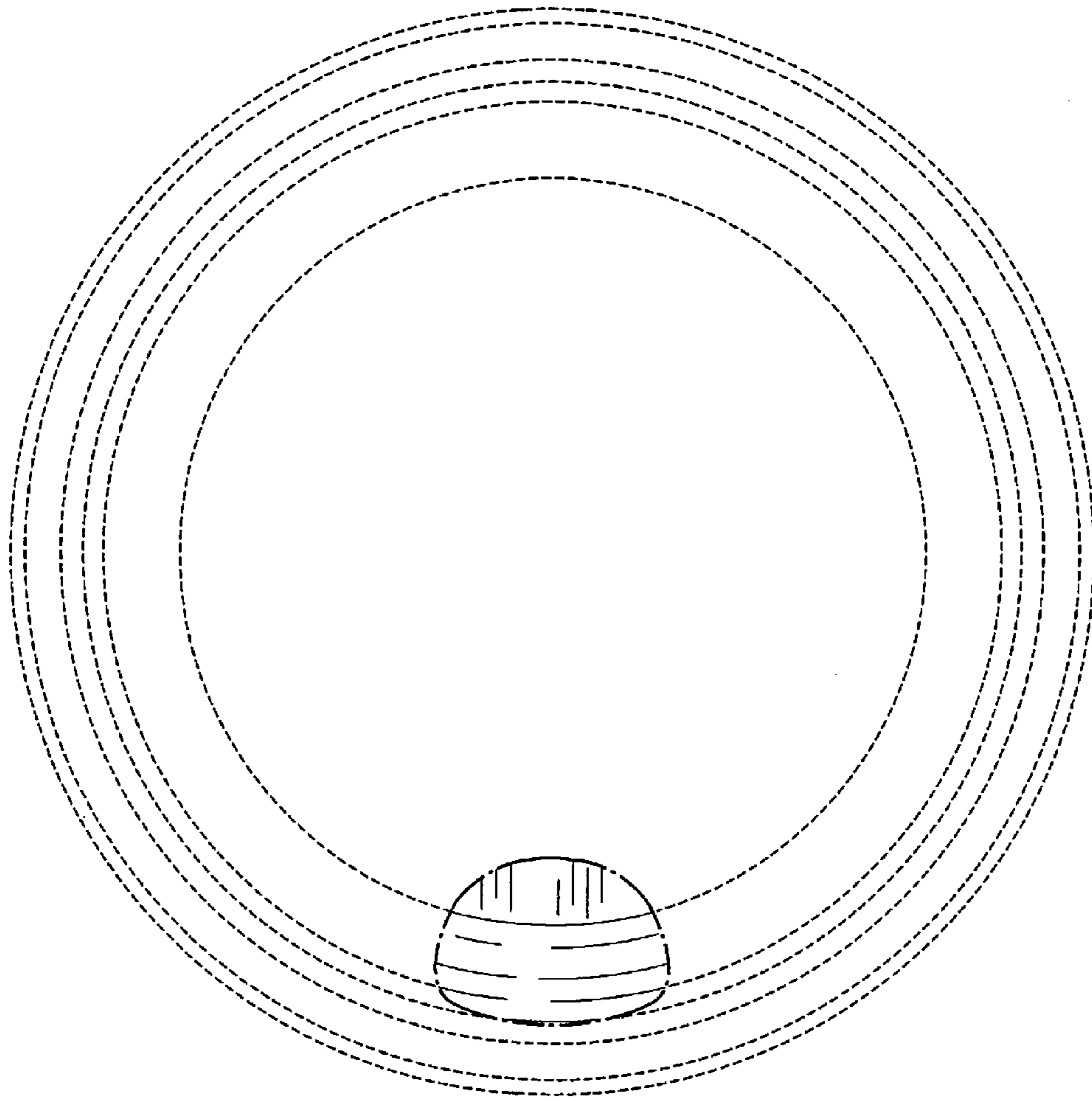

FIG. 7

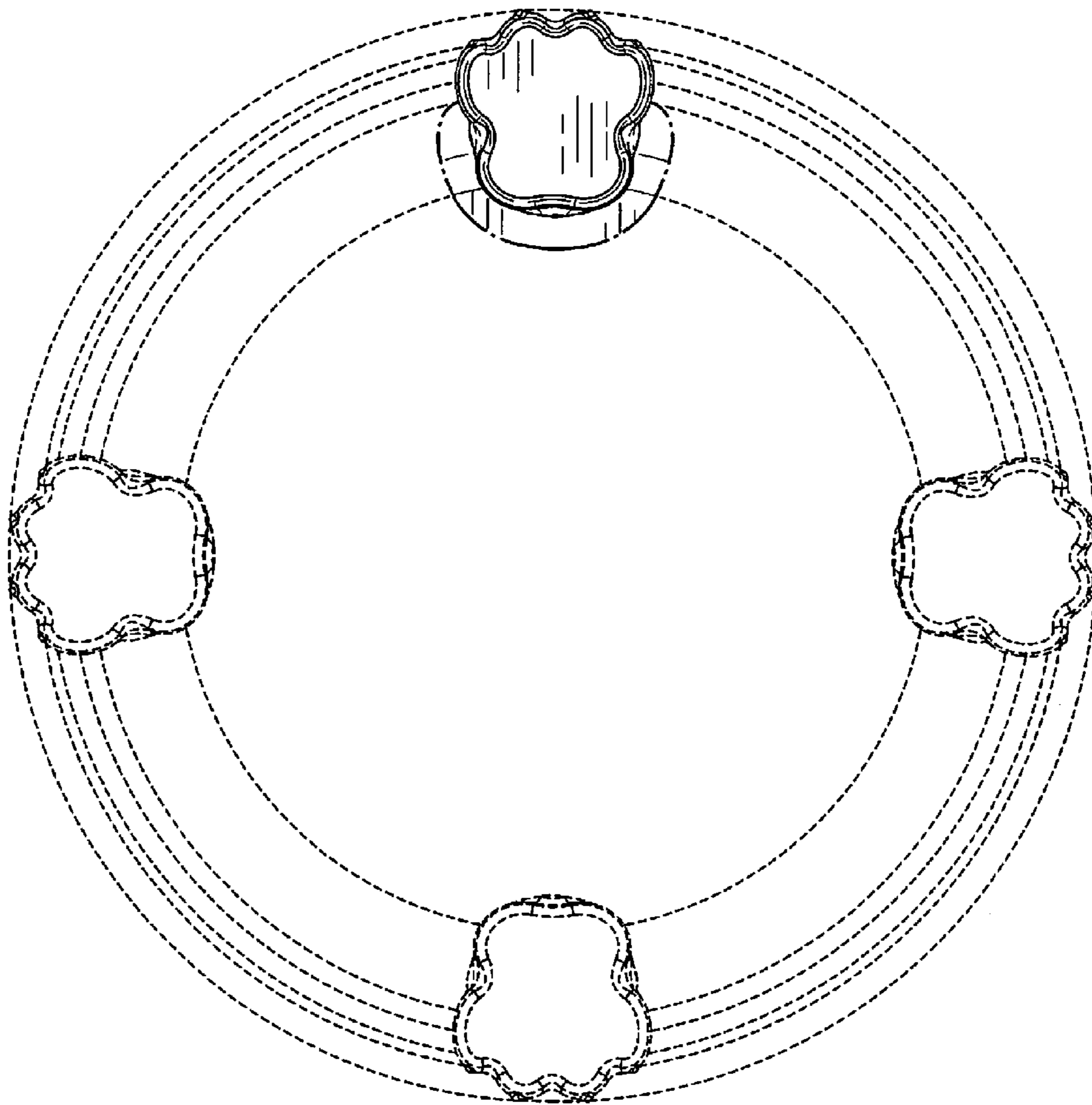

FIG. 8