



US00D738603S

(12) **United States Design Patent**  
**Blair et al.**

(10) **Patent No.:** **US D738,603 S**

(45) **Date of Patent:** **\*\* Sep. 15, 2015**

(54) **SHOE HEEL**

(71) Applicants: **Sharon Blair**, Ellenwood, GA (US);  
**Francis Menjor**, Decatur, GA (US)

(72) Inventors: **Sharon Blair**, Ellenwood, GA (US);  
**Francis Menjor**, Decatur, GA (US)

(\*\*) Term: **14 Years**

(21) Appl. No.: **29/476,420**

(22) Filed: **Dec. 13, 2013**

(51) **LOC (10) Cl.** ..... **02-04**

(52) **U.S. Cl.**  
USPC ..... **D2/965**

(58) **Field of Classification Search**  
USPC ..... D2/915, 916, 925, 918, 922, 946,  
D2/964-966, 976; 36/34 R, 72 B, 72 R, 73,  
36/83, 136  
CPC ..... A43B 21/00; A43B 21/36; A43B 21/39;  
A43B 21/52  
See application file for complete search history.

(56) **References Cited**

**U.S. PATENT DOCUMENTS**

2,284,326	A	5/1942	Korda	
D136,960	S	1/1944	Shuford	
2,414,445	A	1/1947	Cahil	
2,465,817	A	3/1949	Perguria	
D201,002	S	5/1965	Hahn	
3,369,309	A	2/1968	Brooks	
4,041,618	A	8/1977	Famolare	
D347,937	S *	6/1994	Garland	D2/965
D578,286	S *	10/2008	Hogan	D2/964
7,574,819	B2	8/2009	Rie	
D606,730	S *	12/2009	Whittington	D2/910

D635,750	S *	4/2011	Whittington	D2/910
D665,980	S *	8/2012	Ruano Cerdan et al.	D2/965
D666,403	S *	9/2012	Finnegan et al.	D2/966

**OTHER PUBLICATIONS**

Com-pa-ny Double Heels, announced Apr. 2011, [online], site visited Mar. 6, 2015. Available from Internet, <URL: http://www.com-pa-ny.com>.\*

\* cited by examiner

*Primary Examiner* — Derrick Holland

*Assistant Examiner* — Janice Lim

(57) **CLAIM**

The ornamental design for a shoe heel, as shown and described.

**DESCRIPTION**

FIG. 1 is a left side view of a shoe heel, and a right side view being a mirror image thereof, shown in environmental use, showing our new design;

FIG. 2 is a rear view thereof, shown in environmental use;

FIG. 3 is a bottom view thereof, shown in environmental use; FIG. 4 is a top, left side, front perspective view thereof, shown in environmental use;

FIG. 5 is a bottom, left side, rear perspective view thereof, and a bottom, right side, rear perspective view being a mirror image thereof; and,

FIG. 6 is a top, left side, front perspective view thereof, and a top, right side, front perspective view being a mirror image thereof.

The broken line portions of FIGS. 1-4 are included to show unclaimed subject matter only and form no part of the claimed design.

**1 Claim, 6 Drawing Sheets**

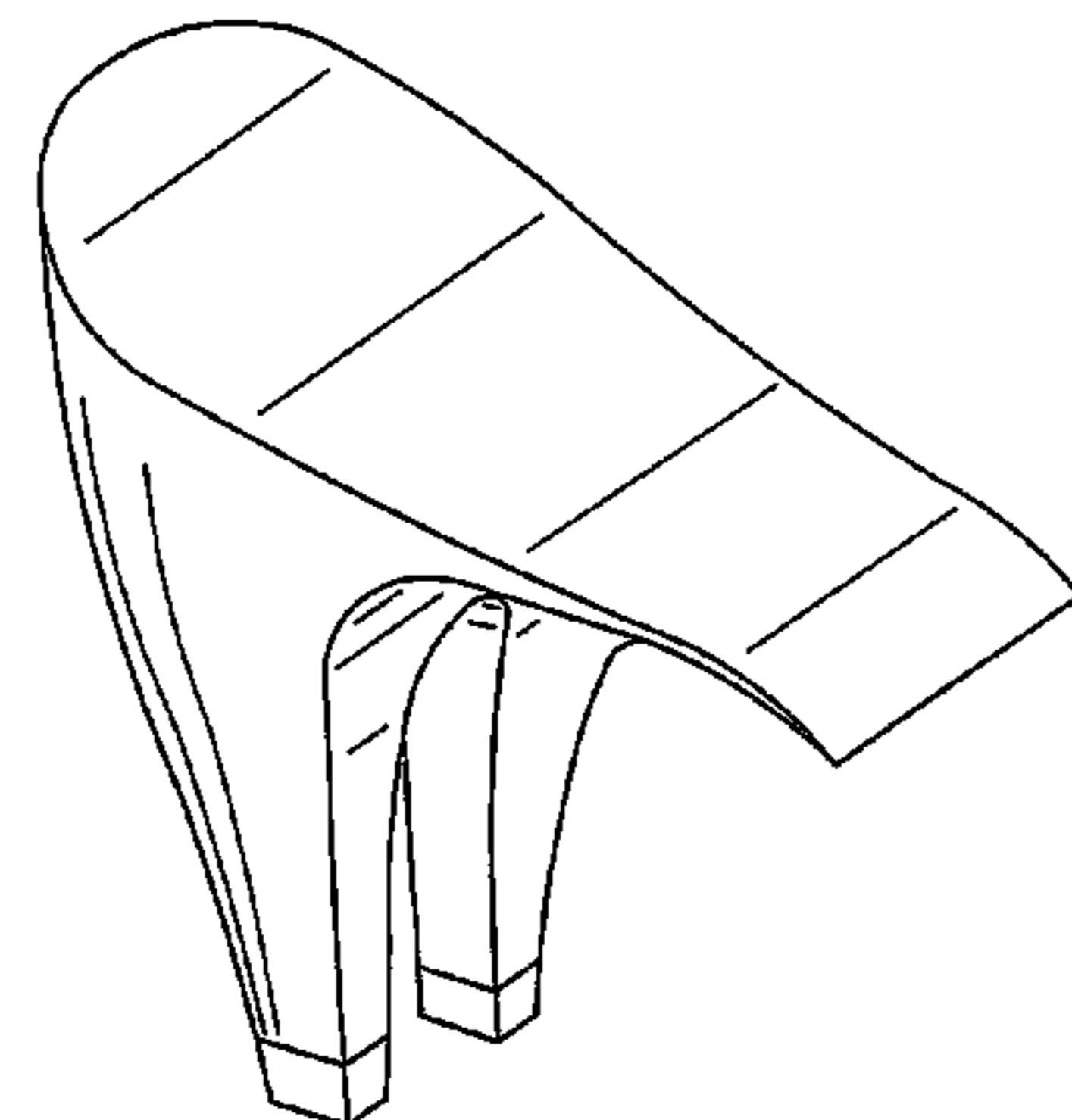
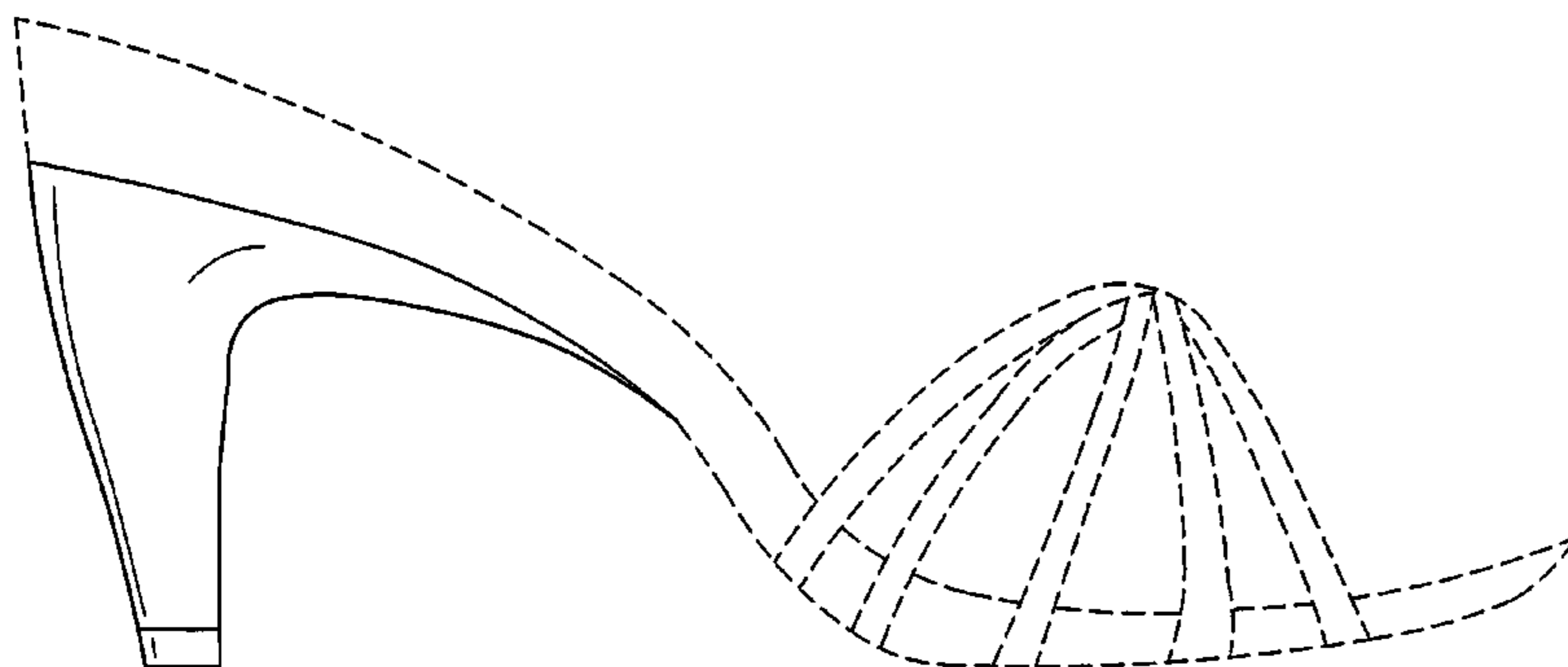

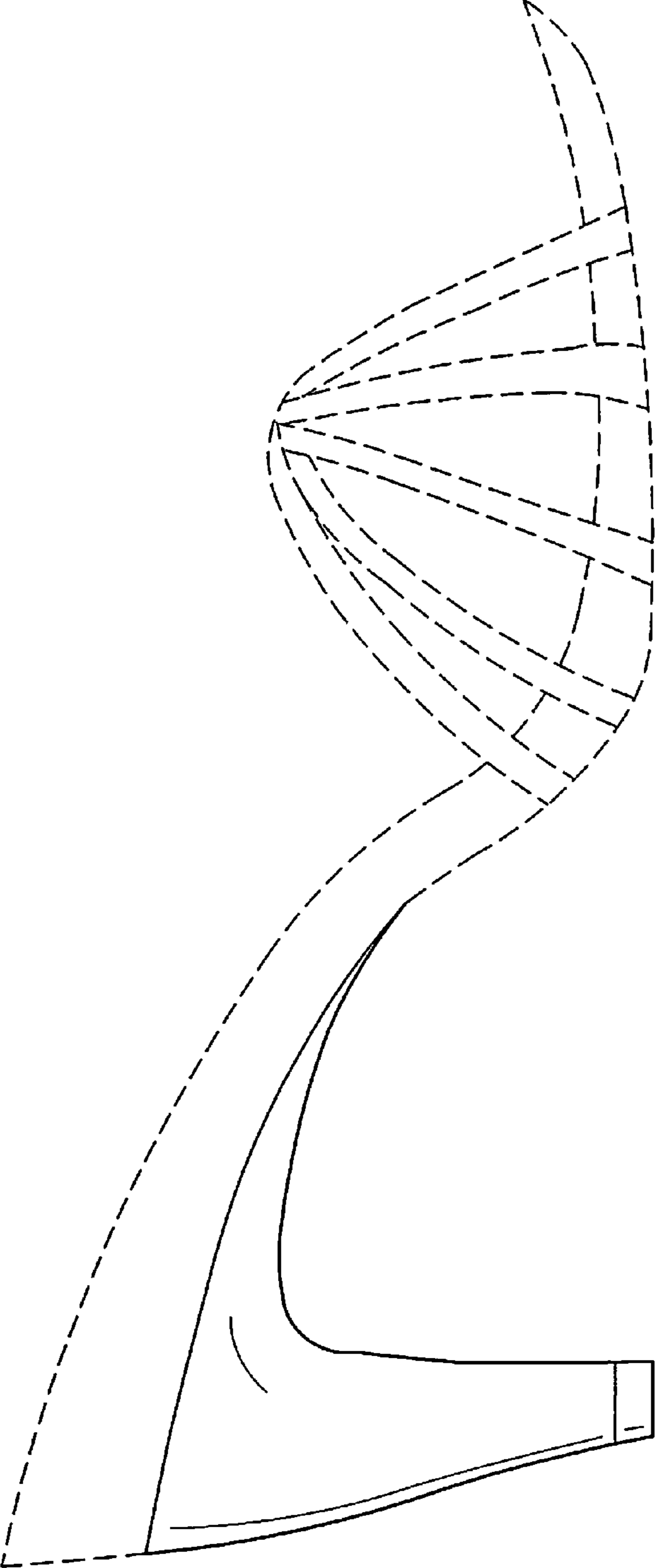

FIG. 1

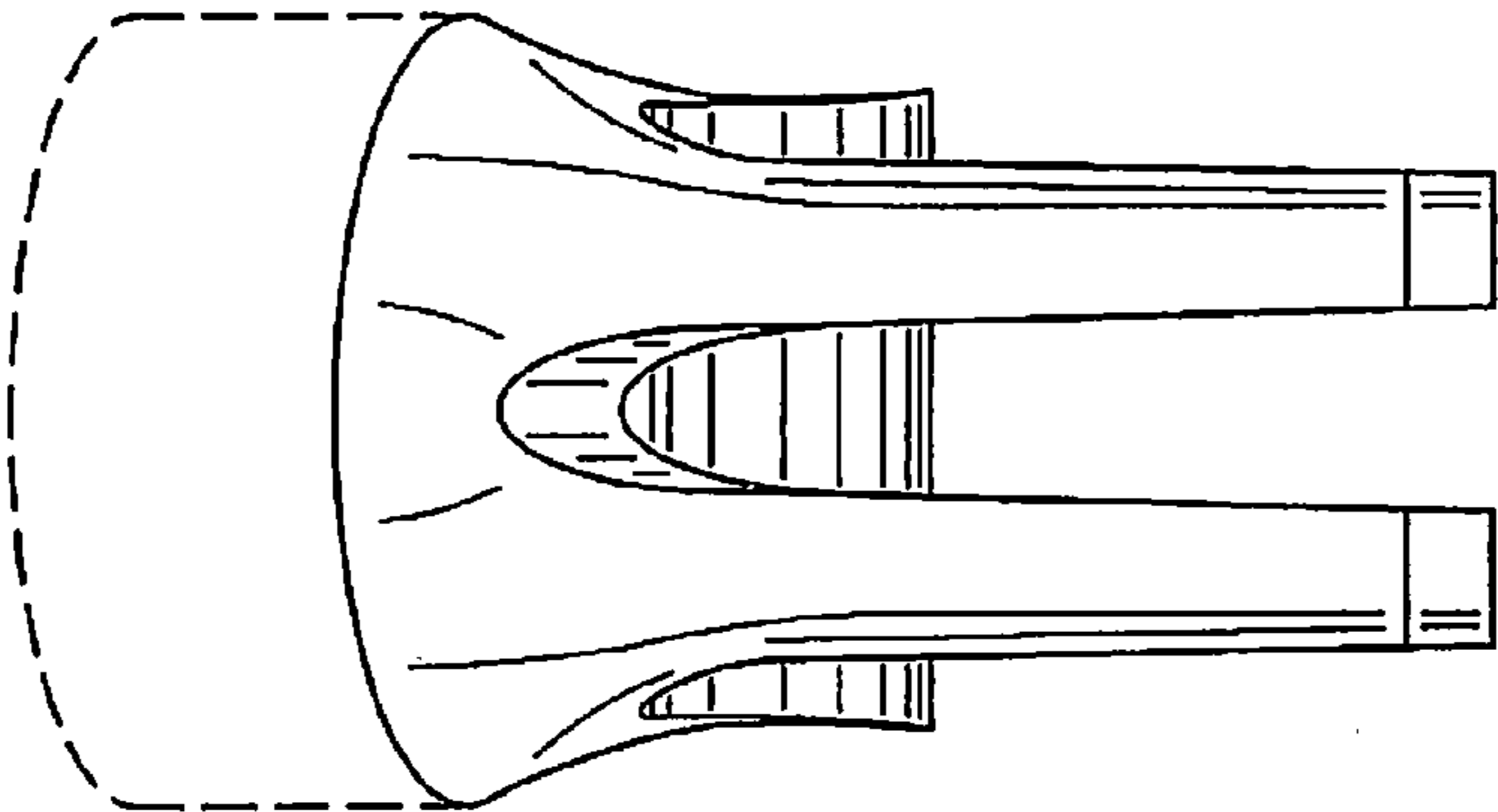

FIG. 2

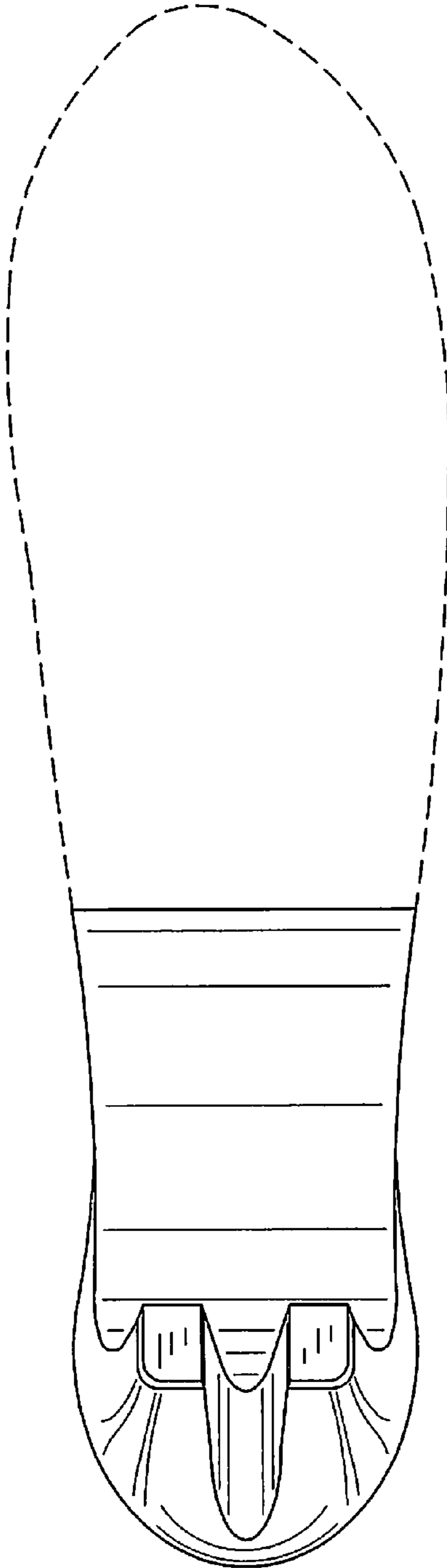

FIG. 3

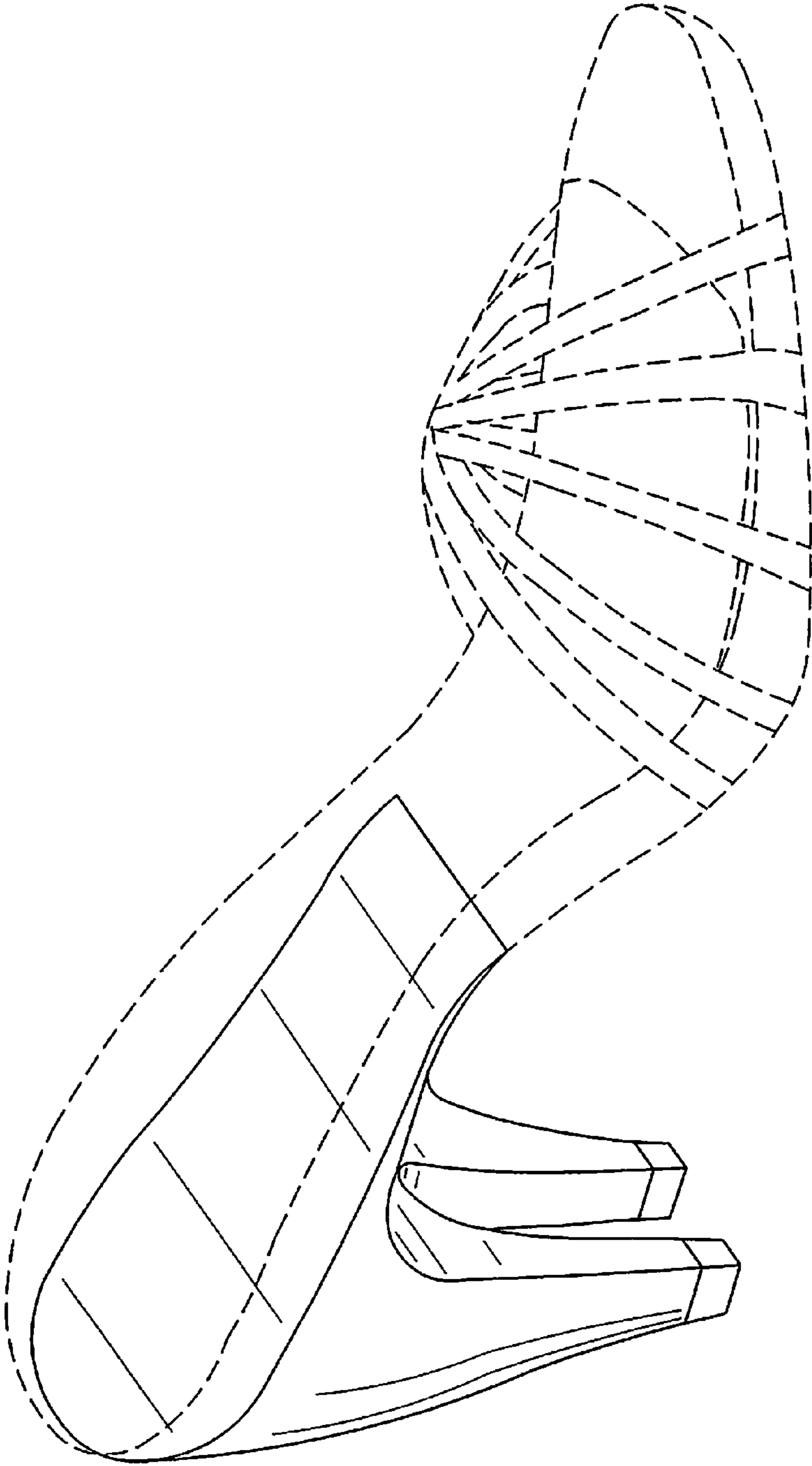

FIG. 4

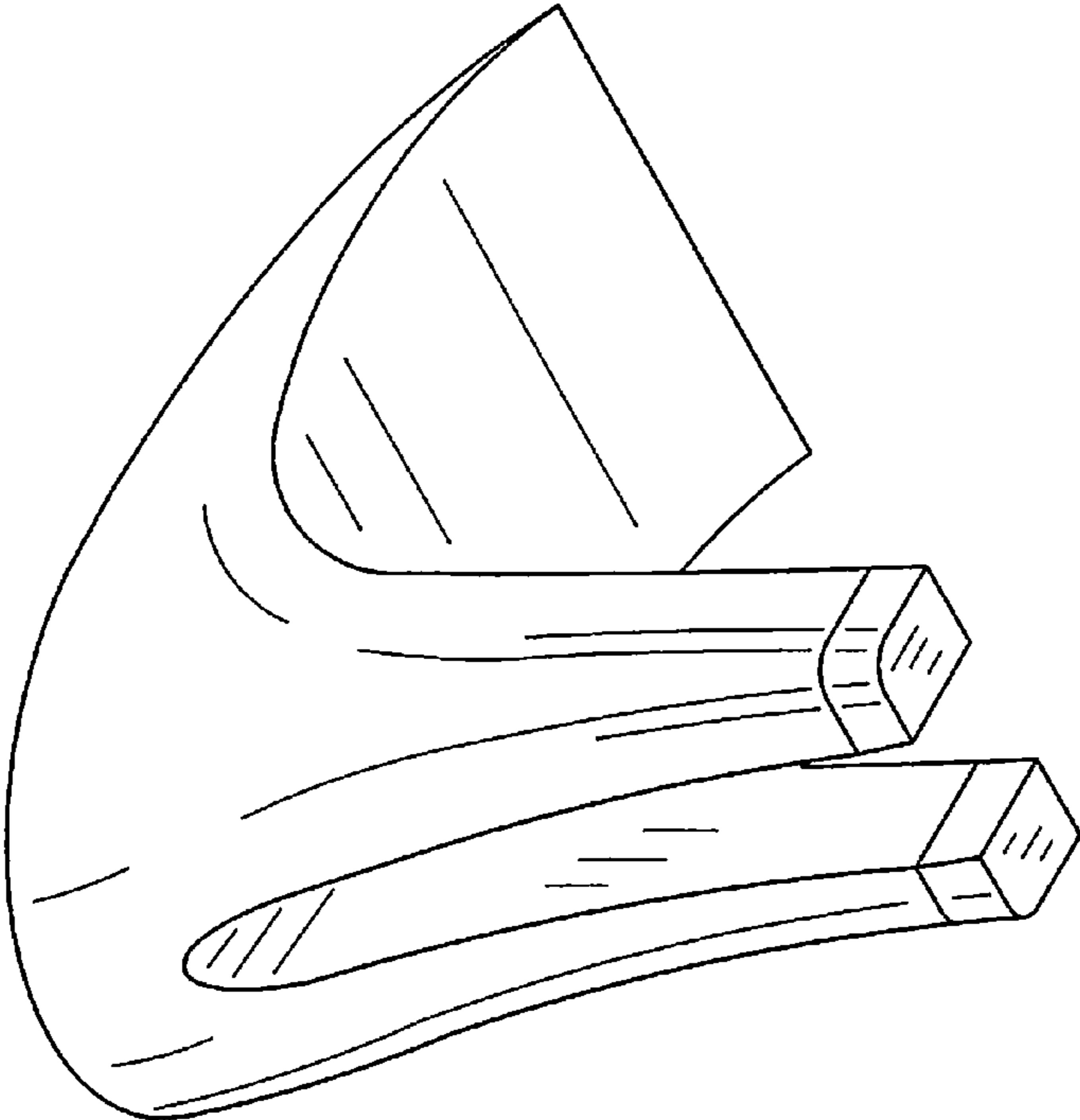

FIG. 5

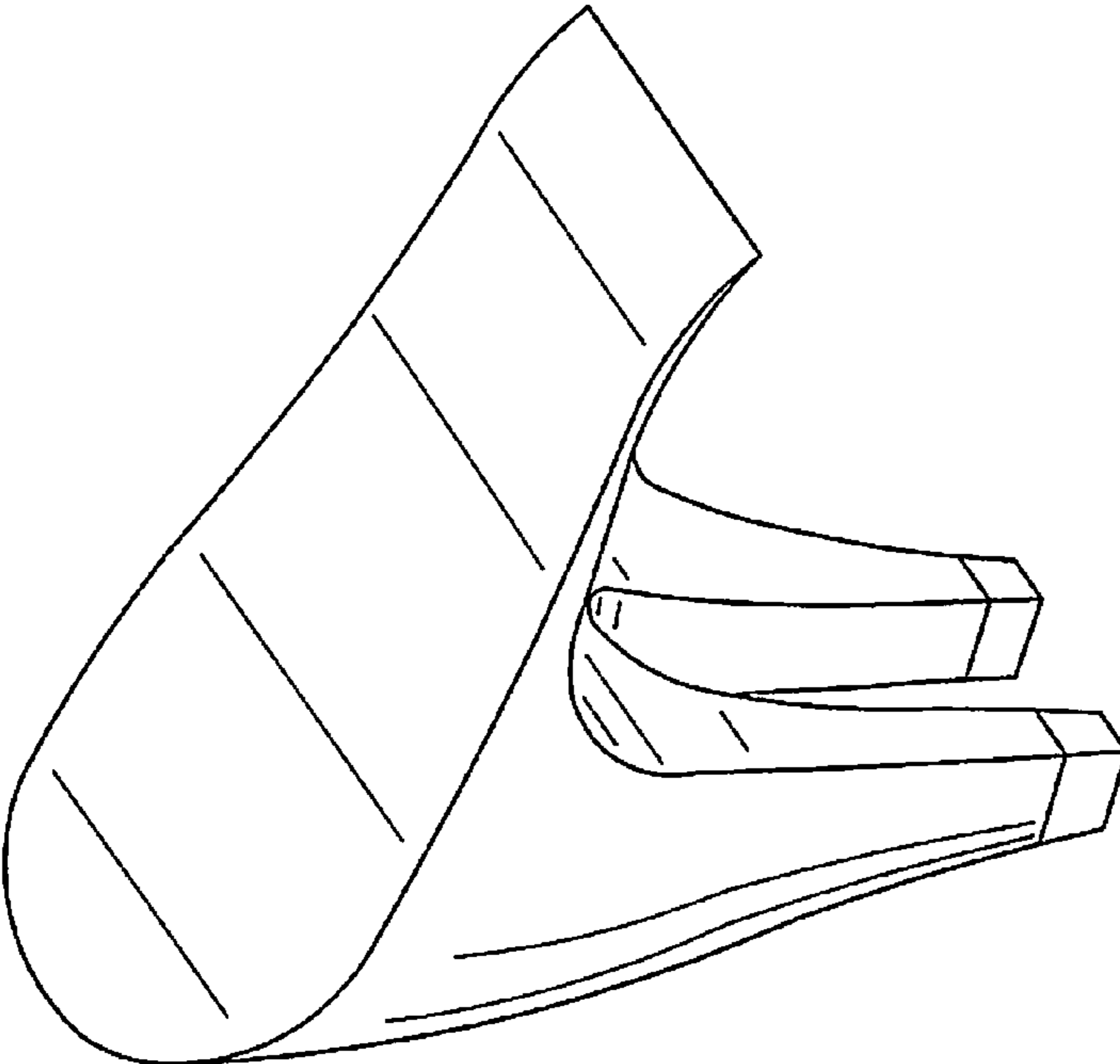

FIG. 6