



US00D738588S

(12) **United States Design Patent**  
**Bergemann et al.**

(10) **Patent No.:** **US D738,588 S**

(45) **Date of Patent:** **\*\* Sep. 8, 2015**

(54) **RECEPTACLE**

(71) Applicant: **The Prestwick Group, Inc.**, Sussex, WI (US)

(72) Inventors: **Jason Bergemann**, Milwaukee, WI (US); **Tyler Morse**, Nashotah, WI (US)

(73) Assignee: **The Prestwick Group, LLC**, Sussex, WI (US)

(\*\*) Term: **14 Years**

(21) Appl. No.: **29/475,679**

(22) Filed: **Dec. 5, 2013**

(51) **LOC (10) Cl.** ..... **09-09**

(52) **U.S. Cl.**  
USPC ..... **D34/7**

(58) **Field of Classification Search**  
USPC ..... D34/1-11; 220/908, 909, 908.1, 911;  
232/43.1, 43.2  
CPC .... B65F 1/1426; B65F 1/1405; B65F 1/1415;  
B65F 1/14; B65F 1/067; B65F 1/0033  
See application file for complete search history.

(56) **References Cited**

**U.S. PATENT DOCUMENTS**

3,893,615 A \* 7/1975 Johnson ..... 232/43.2  
D292,037 S \* 9/1987 Hanifl ..... D34/7

(Continued)

**OTHER PUBLICATIONS**

Max-R website material, Busser Stations, available at <http://www.max-r.net/store/busser-stations.asp>, illustrating products publically available prior to Dec. 5, 2013, accessed on Jan. 27, 2014, 1 page.

(Continued)

*Primary Examiner* — Cynthia Ramirez

(74) *Attorney, Agent, or Firm* — Reinhart Boerner Van Deuren s.c.

(57) **CLAIM**

We claim the ornamental design for a receptacle, as shown and described.

**DESCRIPTION**

FIG. 1 is a perspective view from above of the claimed design; FIG. 2 is a perspective view from below of the claimed design of FIG. 1; FIG. 3 is a top view of the claimed design of FIG. 1; FIG. 4 is a bottom view of the claimed design of FIG. 1; FIG. 5 is a front view of the claimed design of FIG. 1; FIG. 6 is a rear view of the claimed design of FIG. 1; FIG. 7 is a right side view of the claimed design of FIG. 1; FIG. 8 is a left side view of the claimed design of FIG. 1; FIG. 9 is a perspective view from above of another embodiment of the claimed design; FIG. 10 is a perspective view from below of the claimed design of FIG. 9; FIG. 11 is a top view of the claimed design of FIG. 9; FIG. 12 is a bottom view of the claimed design of FIG. 9; FIG. 13 is a front view of the claimed design of FIG. 9; FIG. 14 is a rear view of the claimed design of FIG. 9; FIG. 15 is a right side view of the claimed design of FIG. 6; and, FIG. 16 is a left side of the claimed design of FIG. 9. The ornamental design which is claimed is shown in solid lines in the drawings. The broken lines in the drawings are for illustrative purposes only and form no part of the claimed design.

**1 Claim, 14 Drawing Sheets**

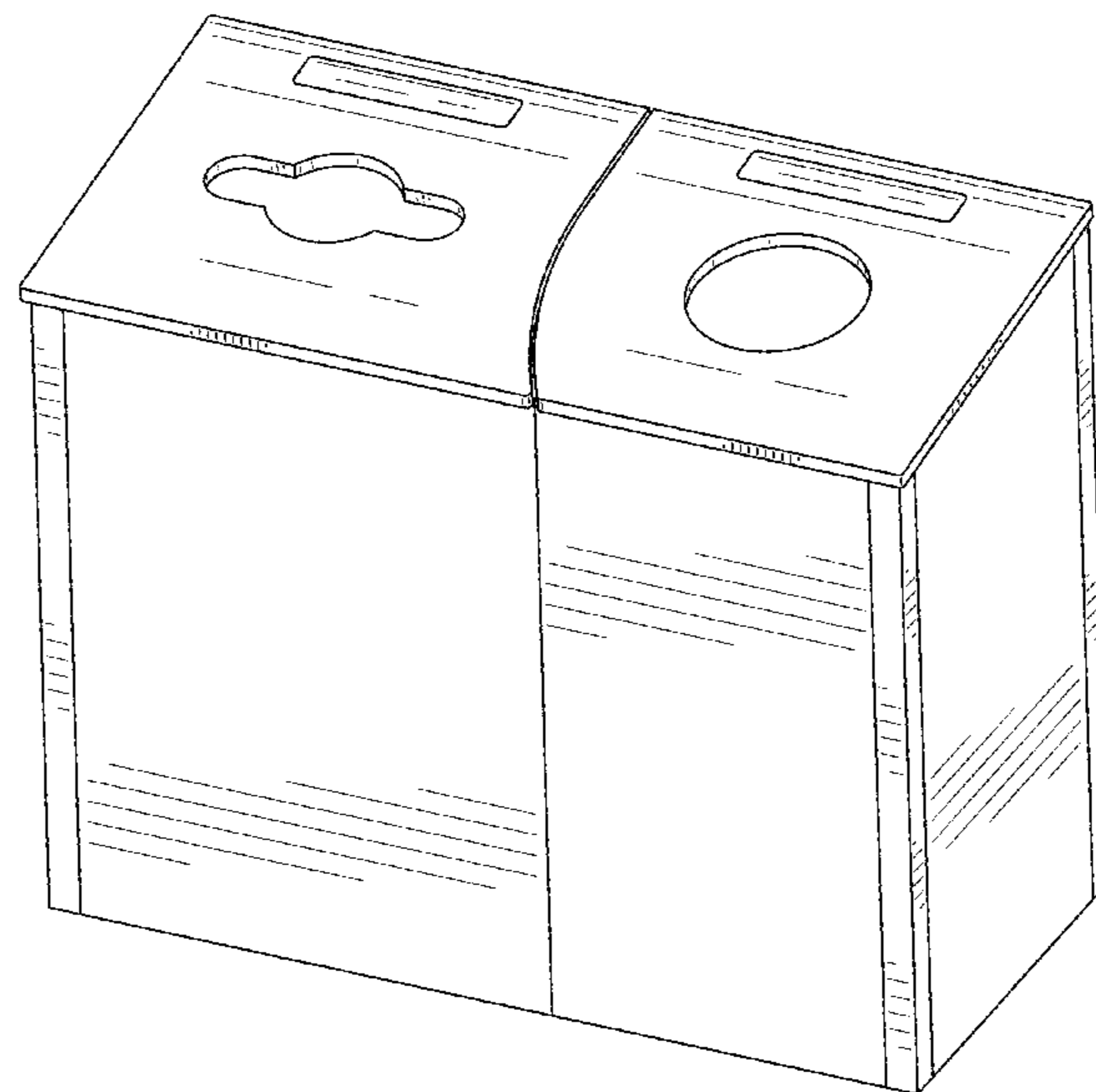

(56)

References Cited

U.S. PATENT DOCUMENTS

5,085,342	A *	2/1992	Strawder	220/495.09
D326,341	S *	5/1992	Frauhiger	D34/1
5,174,468	A *	12/1992	Holderman	220/571
D332,332	S *	1/1993	Markey	D34/1
D333,542	S *	2/1993	McKenzie	D34/9
D334,852	S *	4/1993	Beirise	D6/436
D335,012	S *	4/1993	Broussard	D34/7
D335,730	S *	5/1993	Tessner et al.	D34/7
D339,438	S *	9/1993	Moran	D34/7
D344,381	S *	2/1994	Martin et al.	D34/7
D356,419	S *	3/1995	Kamm	D34/7
D423,167	S *	4/2000	Welch	D34/7
D431,733	S *	10/2000	Zimmerman	D6/446
D477,474	S *	7/2003	Milligan	D6/446
D535,447	S *	1/2007	Olivetti	D34/1
D545,590	S *	7/2007	Good	D6/446
D586,521	S *	2/2009	Pho et al.	D34/11
D591,470	S *	4/2009	Tuncel	D34/7
D596,819	S *	7/2009	Mancini	D34/7
D605,822	S *	12/2009	Cantrell et al.	D34/5
D606,272	S *	12/2009	Cantrell et al.	D34/5
D639,518	S *	6/2011	Zeulner	D34/1
D681,301	S *	4/2013	Bennie et al.	D34/6
2014/0291328	A1 *	10/2014	Jarrett et al.	220/495.07

OTHER PUBLICATIONS

Max-R website material, Restaurants, available at [http://www.max-r.net/cafeteria\\_restuarants.asp](http://www.max-r.net/cafeteria_restuarants.asp), illustrating products publically available prior to Dec. 5, 2013, accessed on Jan. 27, 2014, 2 pages.

Max-R website material, Max-R's Halston Collection—Recycling Bins, Waste Bins, available at [http://www.max-r.net/store/halston\\_collection.asp](http://www.max-r.net/store/halston_collection.asp), illustrating products publically available prior to Dec. 5, 2013, accessed on Jan. 27, 2014, 2 pages.

Max-R website material, Lamboo® Material, available at <http://www.max-r.net/lamboo.asp>, illustrating products publically available prior to Dec. 5, 2013, accessed on Jan. 27, 2014, 2 pages.

Max-R website material, Oxford Collection—Recycling Bins, Waste Bins, available at [http://www.max-r.net/store/oxford\\_collection.asp](http://www.max-r.net/store/oxford_collection.asp), illustrating products publically available prior to Dec. 5, 2013, accessed on Jan. 27, 2014, 2 pages.

Max-R website material, Max-R's Terra Collection—Recycling Bins, Waste Bins, available at [http://www.max-r.net/store/terra\\_collection.asp](http://www.max-r.net/store/terra_collection.asp), illustrating products publically available prior to Dec. 5, 2013, accessed on Jan. 27, 2014, 2 pages.

Max-R website material, Towel Stations, available at <http://www.max-r.net/store/towel-stations.asp>, illustrating products publically available prior to Dec. 5, 2013, accessed on Jan. 27, 2014, 1 page.

Max-R website material, Tuscany Collection—Waste Recycling Bins, available at [http://www.max-r.net/store/tuscany\\_collection.asp](http://www.max-r.net/store/tuscany_collection.asp), illustrating products publically available prior to Dec. 5, 2013, accessed on Jan. 27, 2014, 2 pages.

Max-R website material, Max-R's Verde Collection—Recycling Bins, Waste Bins, available at [http://www.max-r.net/store/verde\\_collection.asp](http://www.max-r.net/store/verde_collection.asp), illustrating products publically available prior to Dec. 5, 2013, accessed on Jan. 27, 2014, 2 pages.

Max-R website material, Waste and Recycling Bins p. 1, available at <http://www.max-r.net/store/waste-and-recycling-bins.asp>, illustrating products publically available prior to Dec. 5, 2013, accessed on Jan. 27, 2014, 2 pages.

Max-R website material, Waste and Recycling Bins p. 2, available at <http://www.max-r.net/store/waste-and-recycling-bins.asp>, illustrating products publically available prior to Dec. 5, 2013, accessed on Jan. 27, 2014, 2 pages.

Max-R website material, Waste and Recycling Bins p. 3, available at <http://www.max-r.net/store/waste-and-recycling-bins.asp>, illustrating products publically available prior to Dec. 5, 2013, accessed on Jan. 27, 2014, 2 pages.

Max-R website material, Waste and Recycling Bins p. 4, available at <http://www.max-r.net/store/waste-and-recycling-bins.asp>, illustrating products publically available prior to Dec. 5, 2013, accessed on Jan. 27, 2014, 2 pages.

Max-R website material, Waste and Recycling Bins p. 5, available at <http://www.max-r.net/store/waste-and-recycling-bins.asp>, illustrating products publically available prior to Dec. 5, 2013, accessed on Jan. 27, 2014, 2 pages.

Max-R website material, Waste and Recycling Bins p. 6, available at <http://www.max-r.net/store/waste-and-recycling-bins.asp>, illustrating products publically available prior to Dec. 5, 2013, accessed on Jan. 27, 2014, 2 pages.

Max-R website material, Waste and Recycling Bins p. 7, available at <http://www.max-r.net/store/waste-and-recycling-bins.asp>, illustrating products publically available prior to Dec. 5, 2013, accessed on Jan. 27, 2014, 2 pages.

Max-R website material, Waste and Recycling Bins p. 8, available at <http://www.max-r.net/store/waste-and-recycling-bins.asp>, illustrating products publically available prior to Dec. 5, 2013, accessed on Jan. 27, 2014, 2 pages.

Waste/Recycle Unit Specifications and Bin and Meeting Room Waste/Recycle Bin Concept Drawings, conceived of and drawn by third party, dated May 7, 2012, 3 pages.

\* cited by examiner



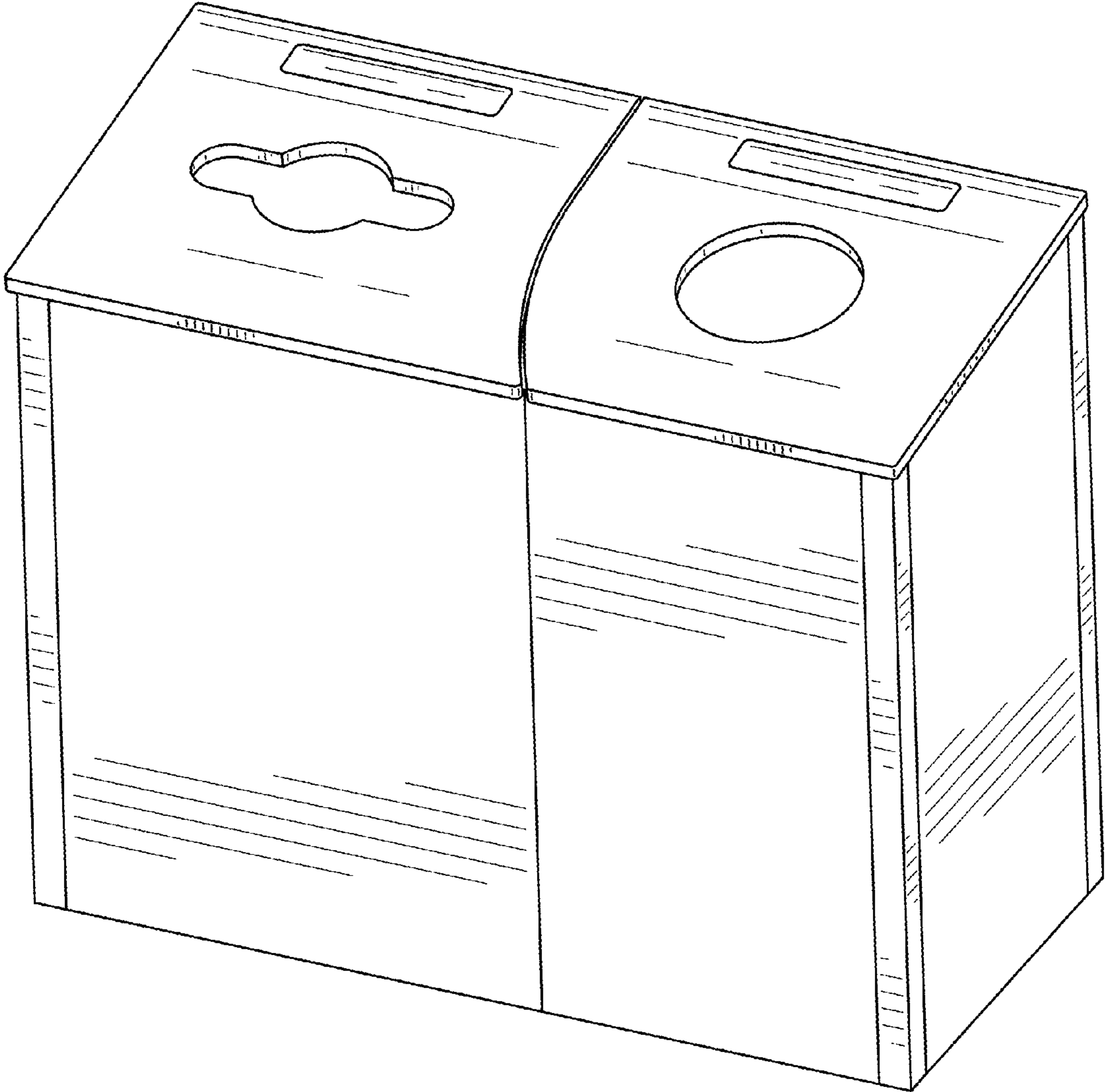

FIG. 1

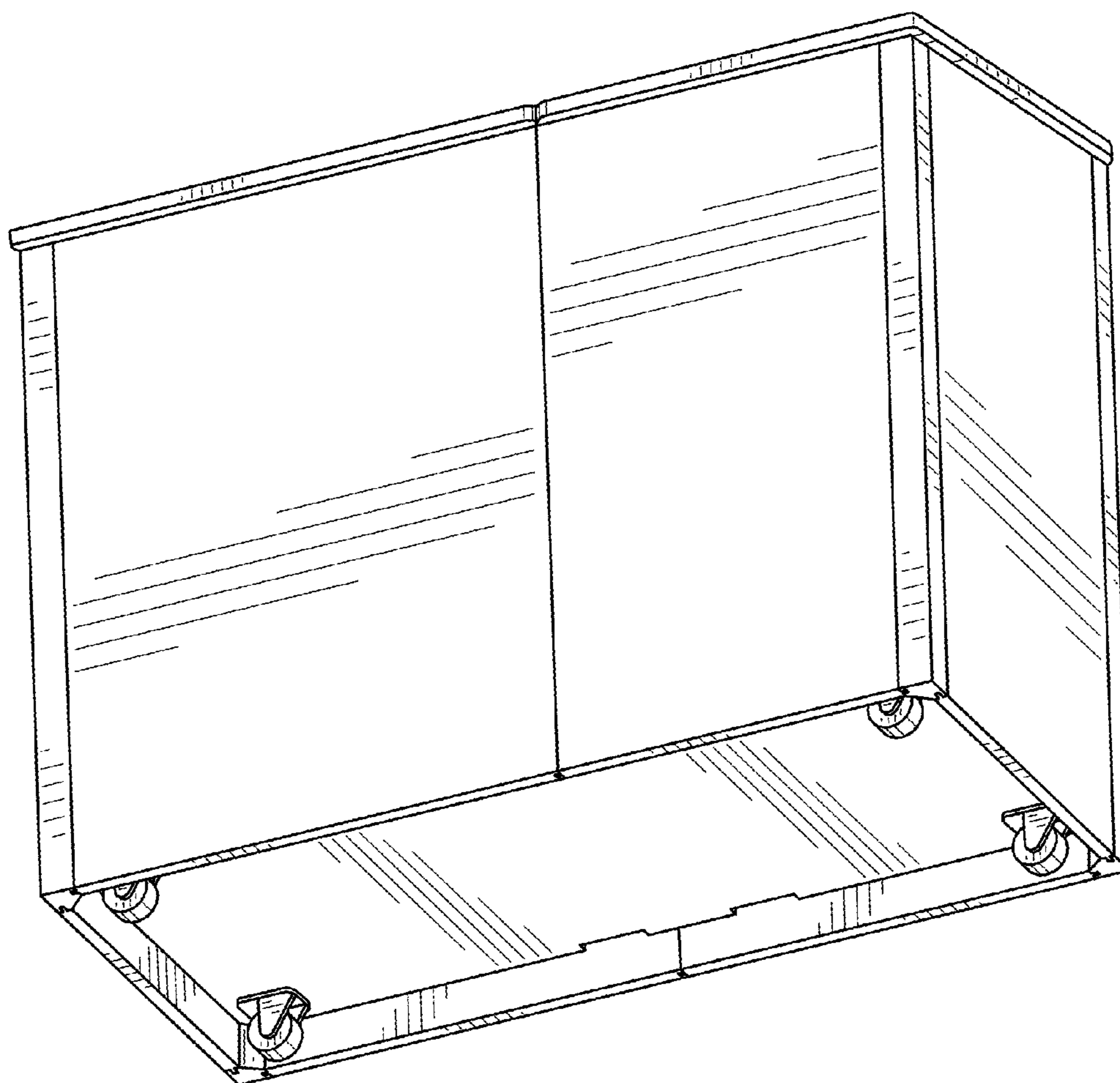

FIG. 2

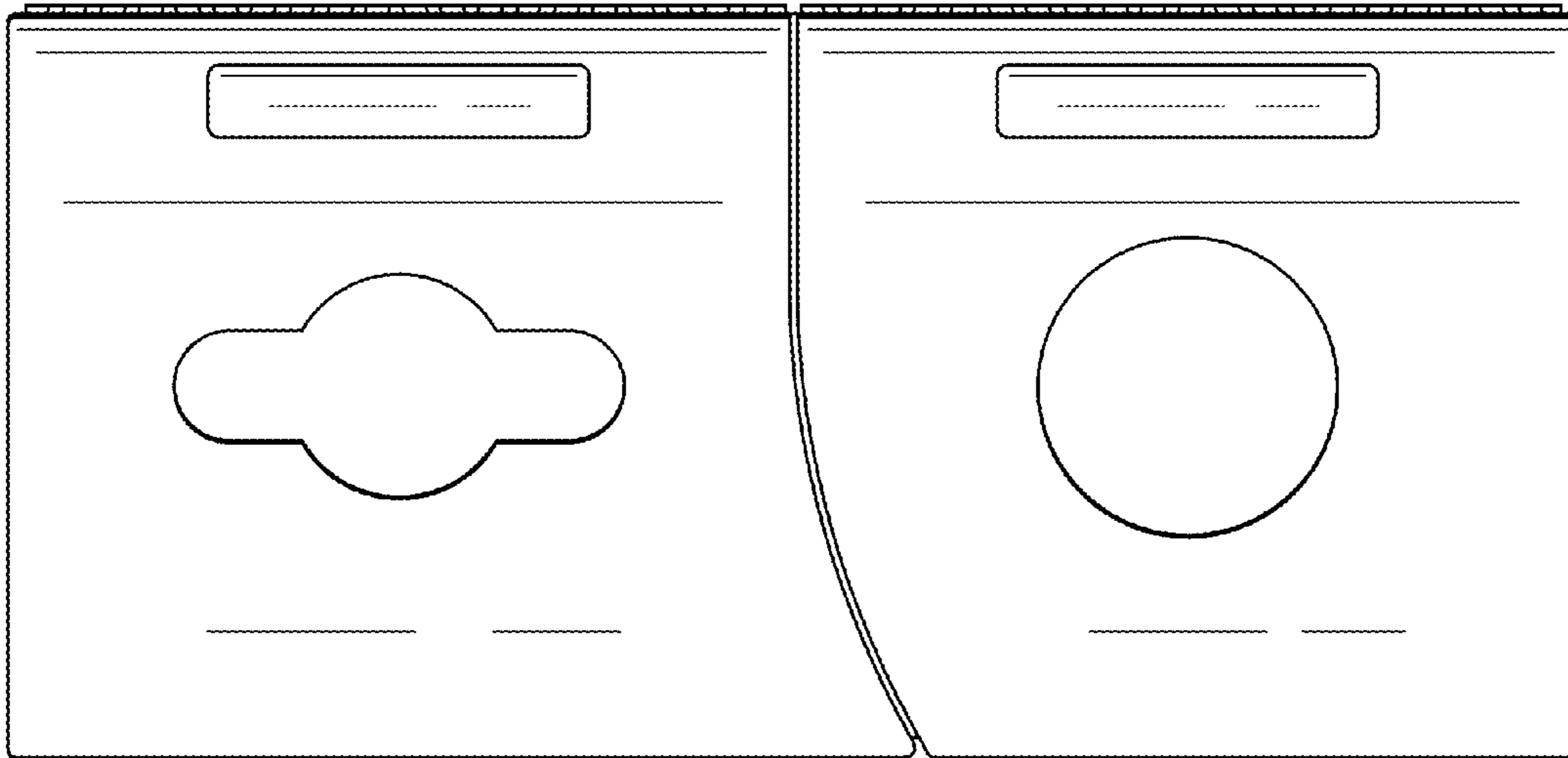

FIG. 3

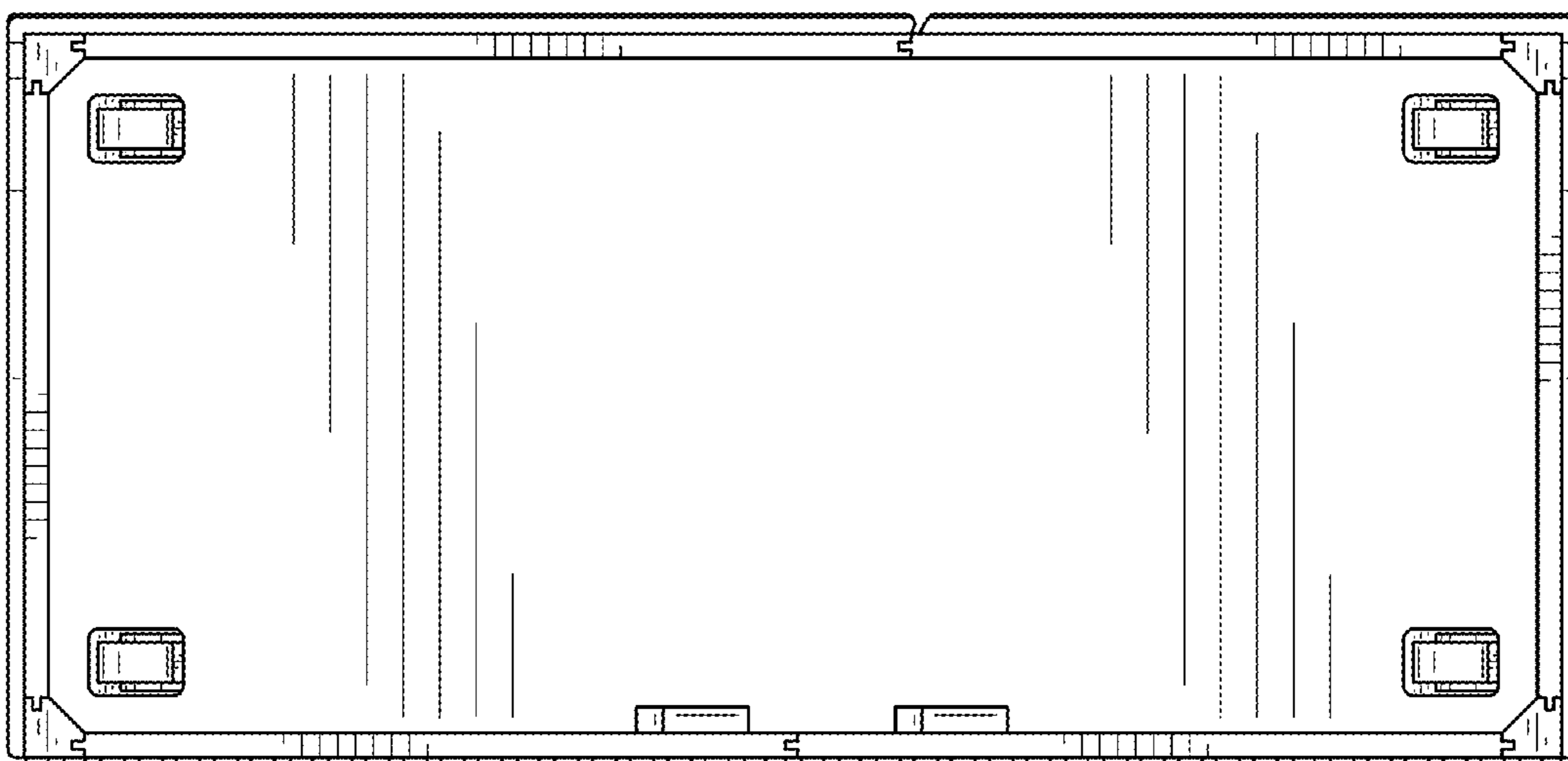

FIG. 4

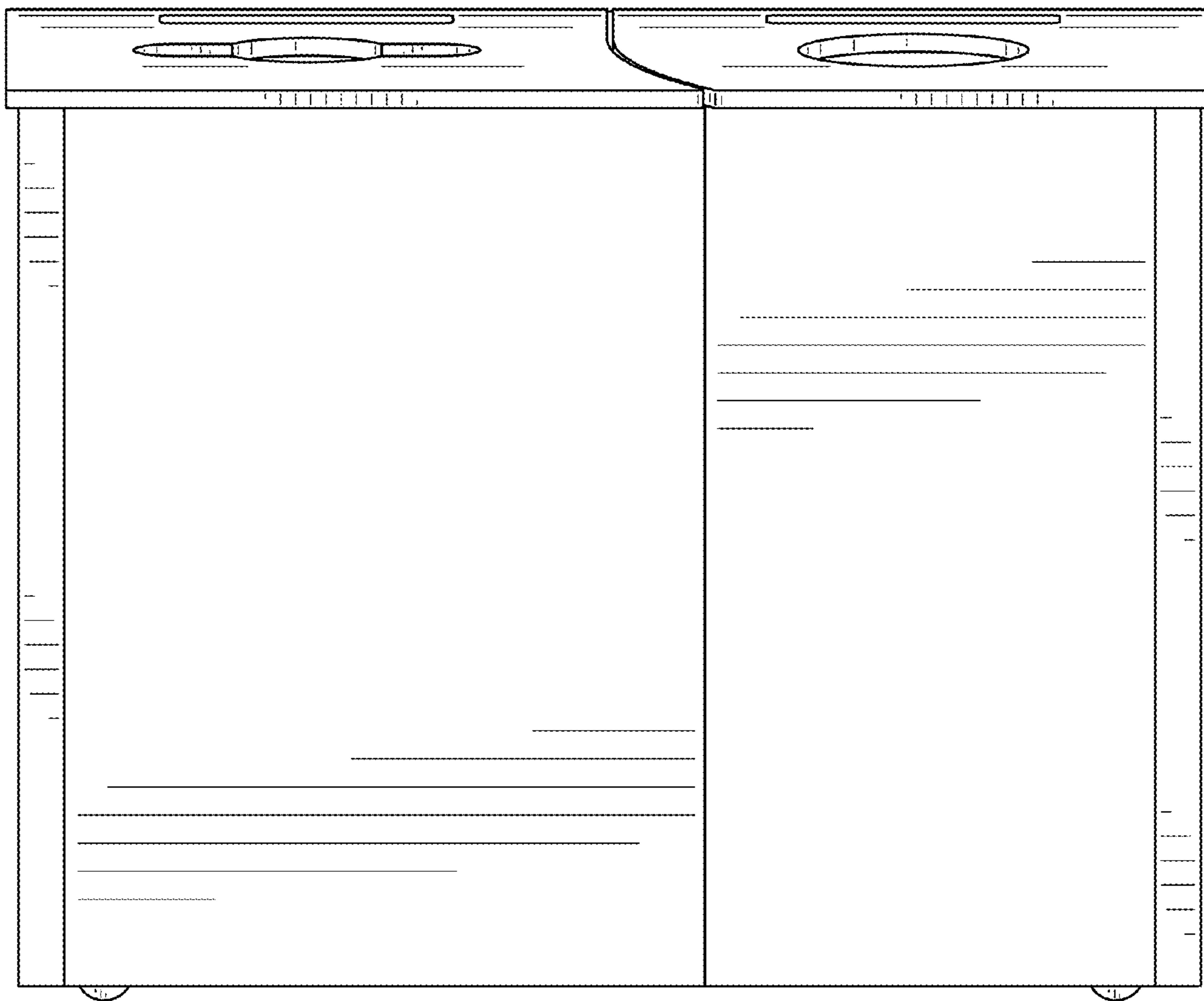

FIG. 5

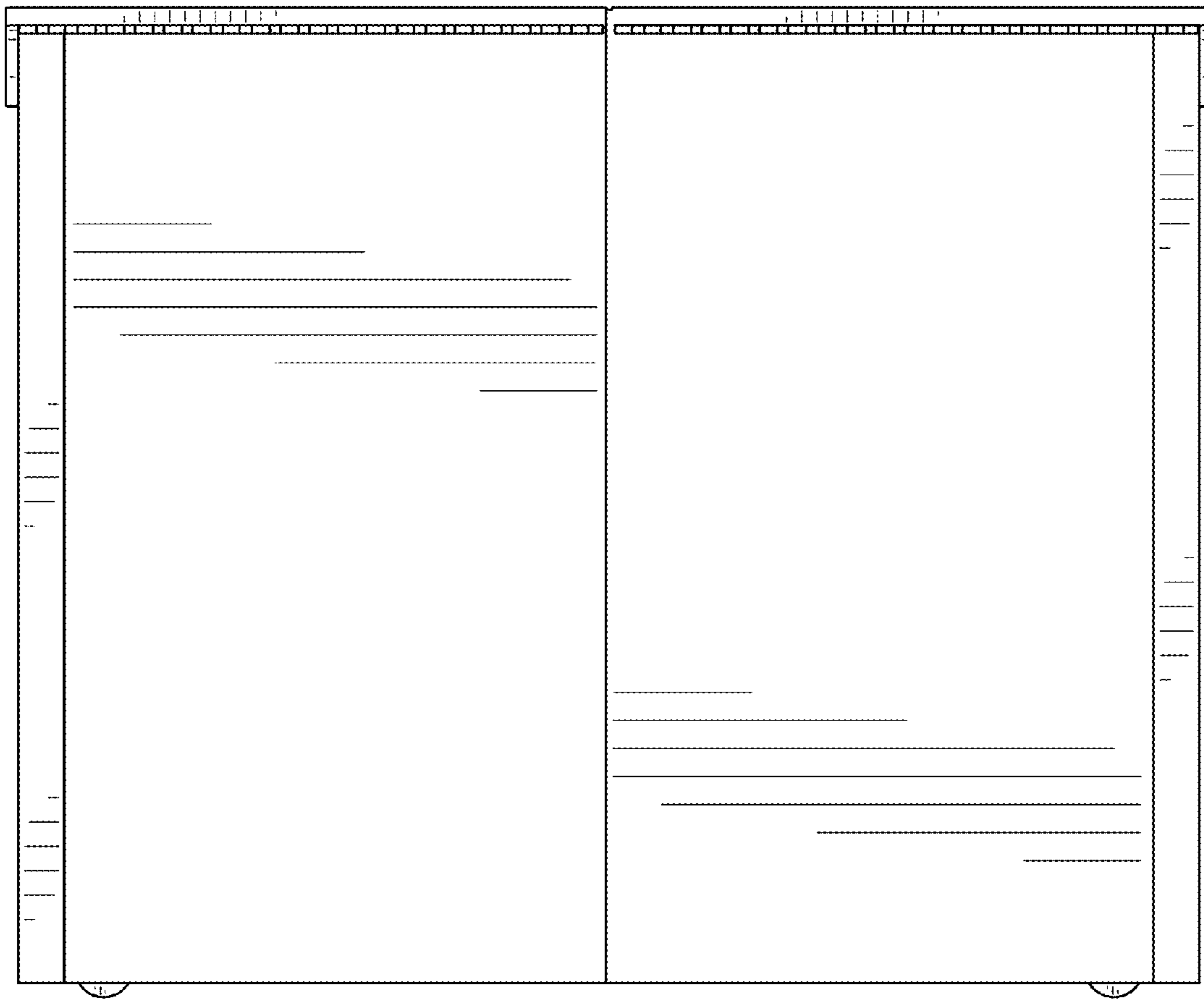

FIG. 6

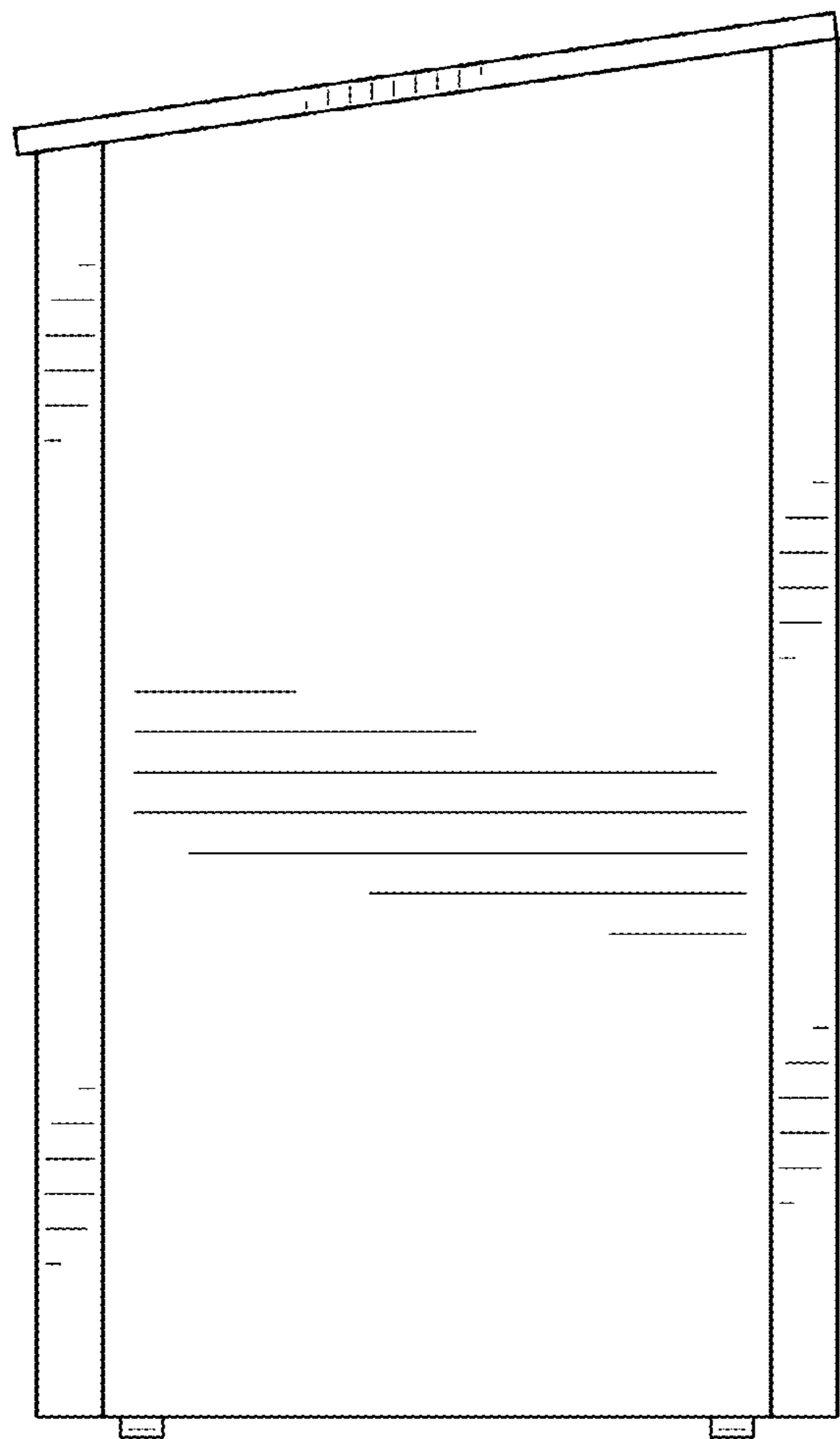

FIG. 7



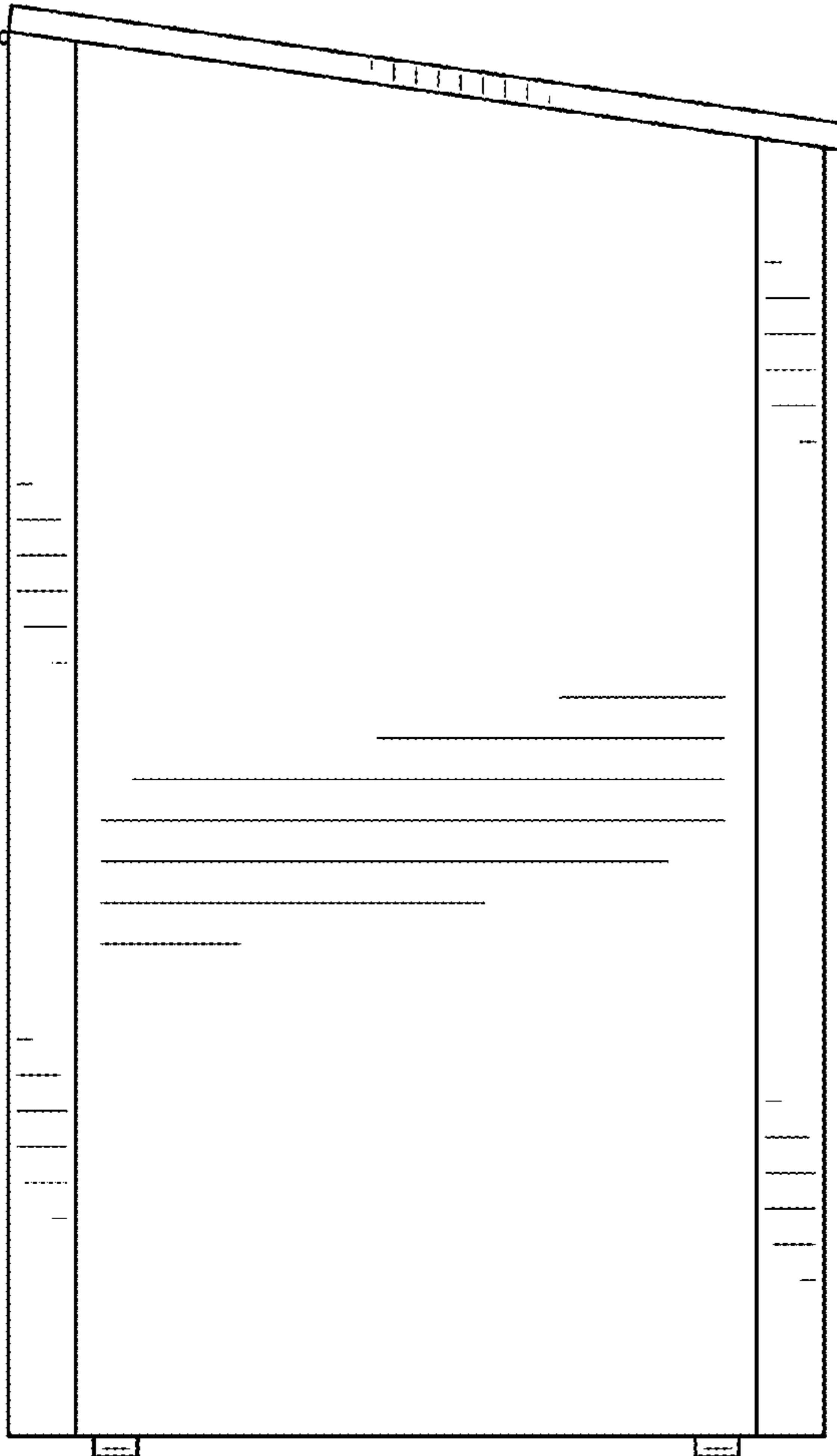

FIG. 8

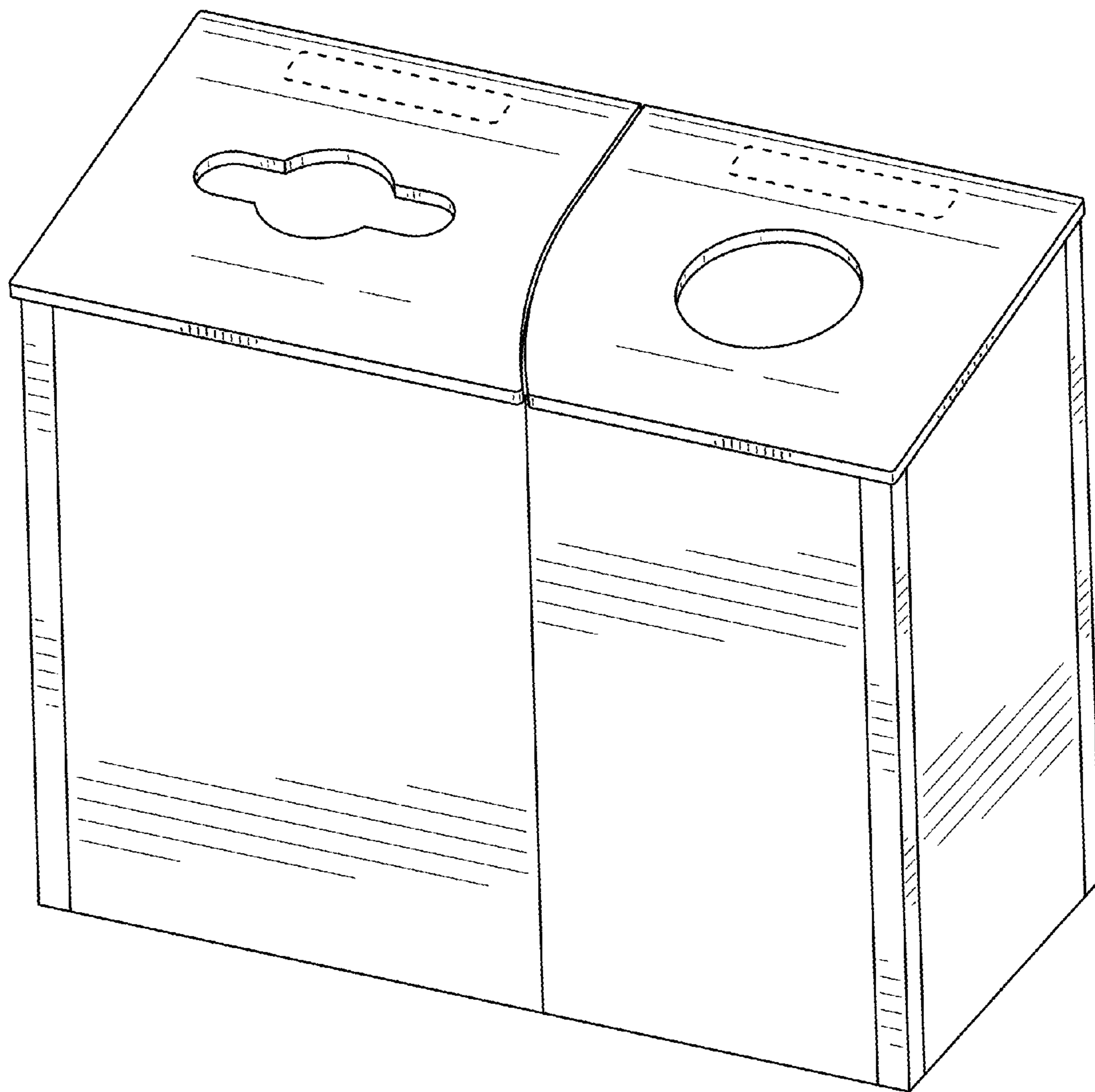

FIG. 9

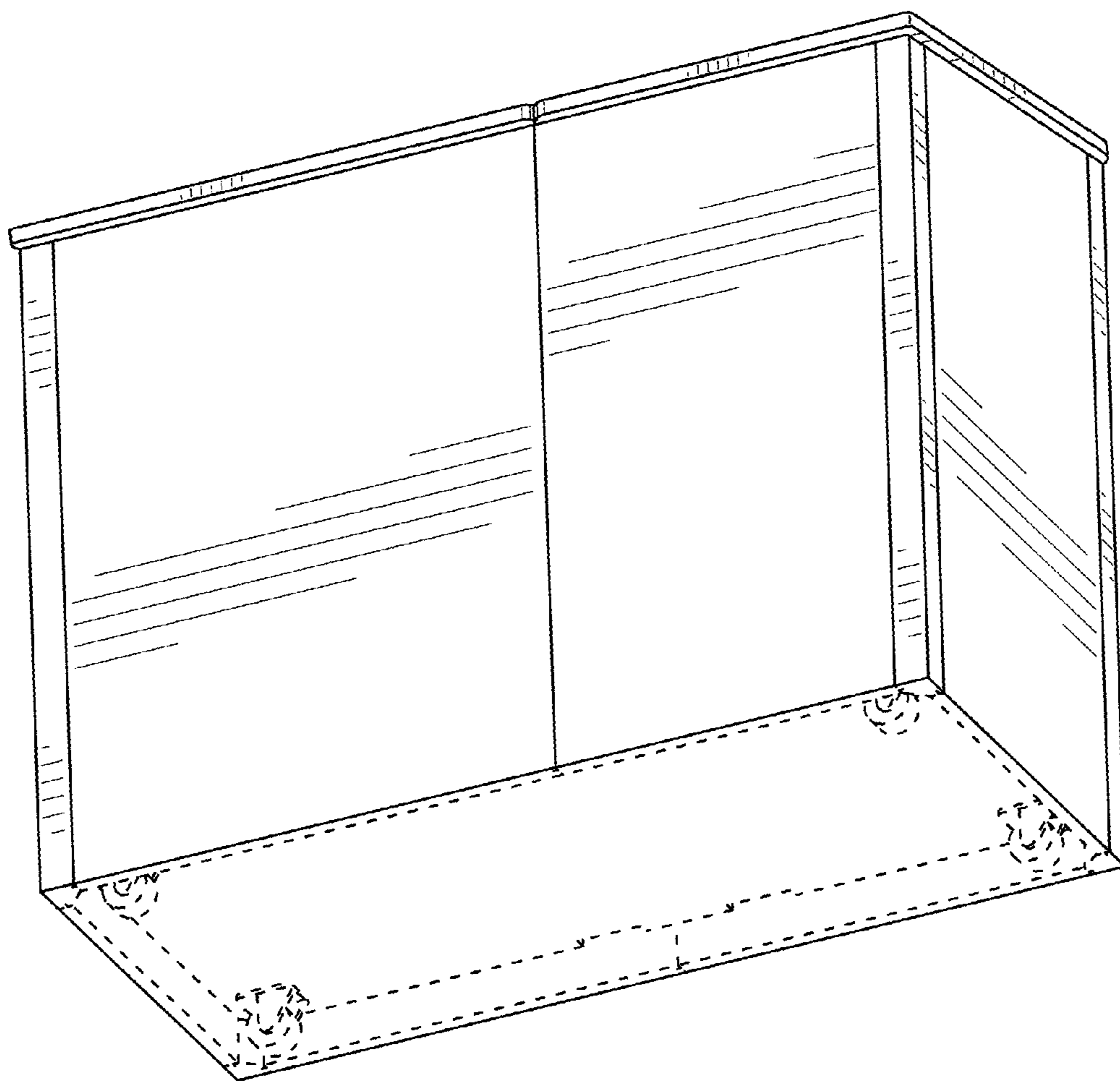

FIG. 10

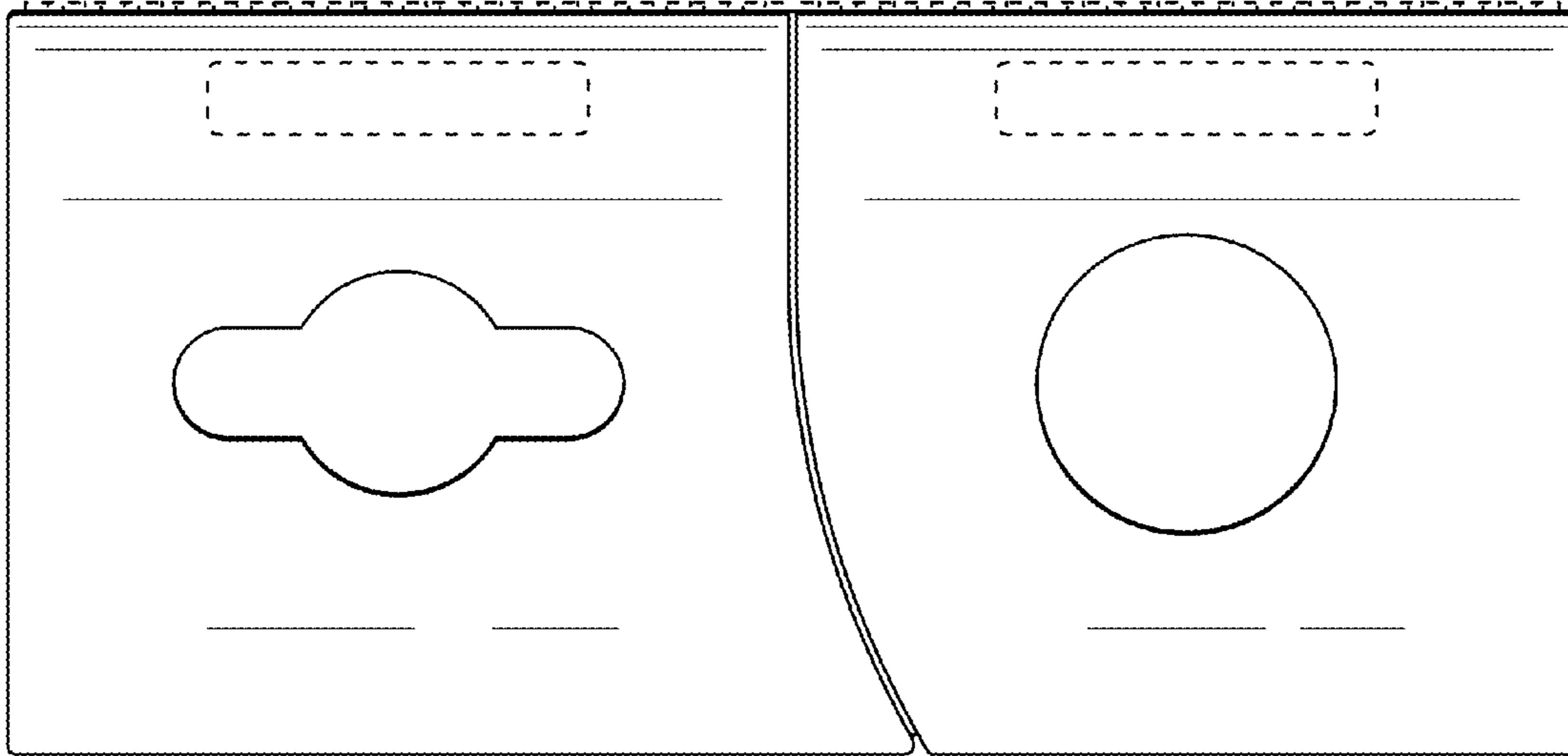

FIG. 11

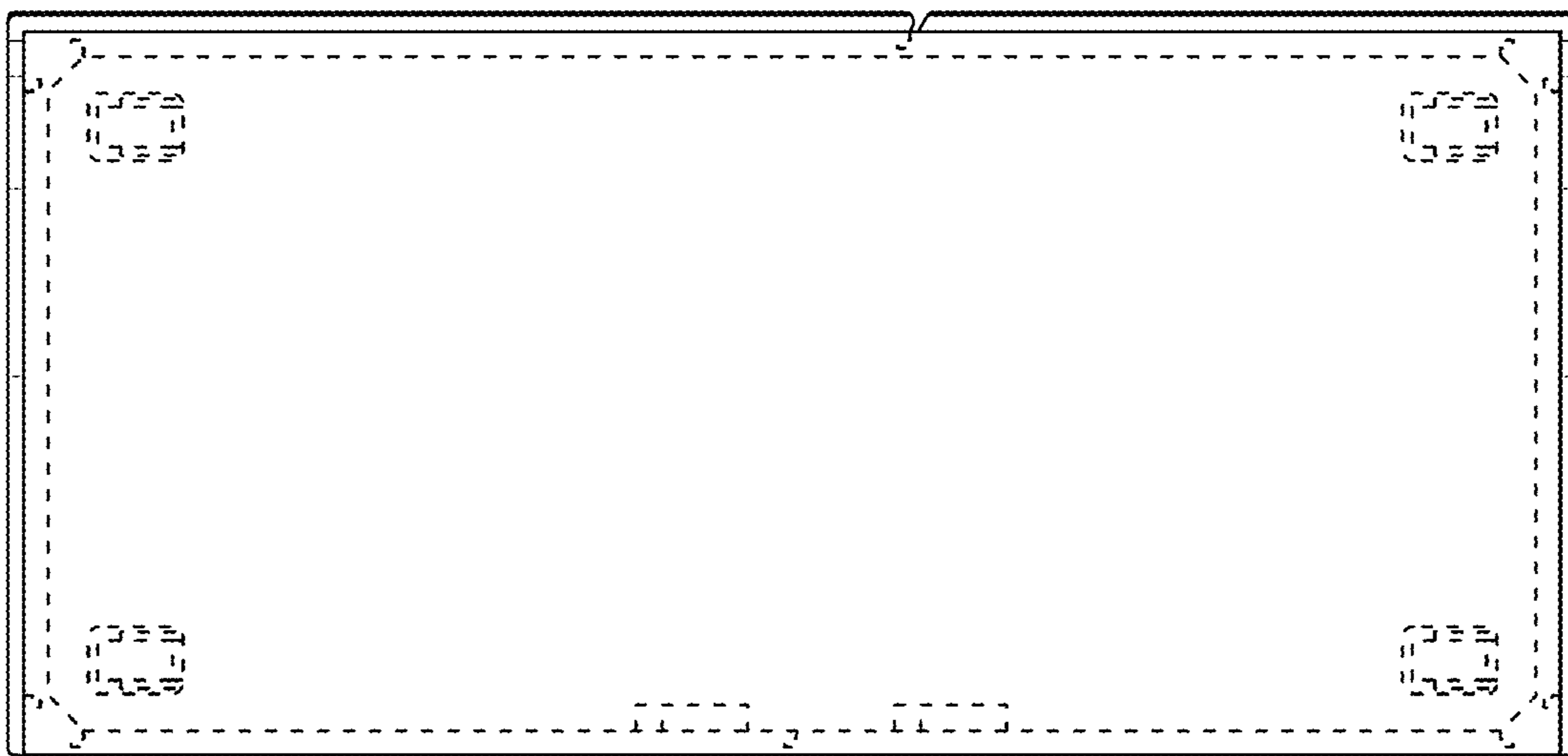

FIG. 12

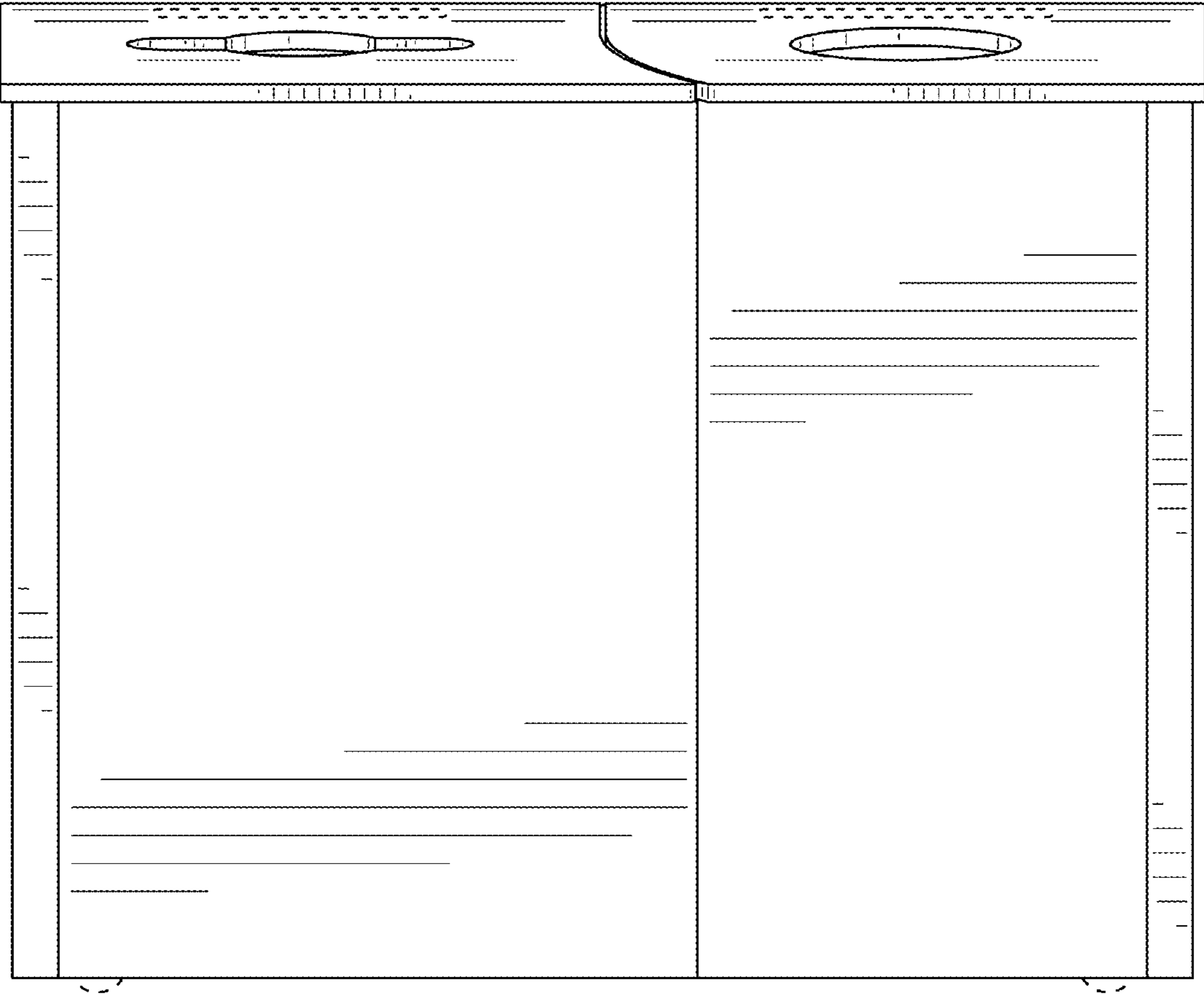

FIG. 13



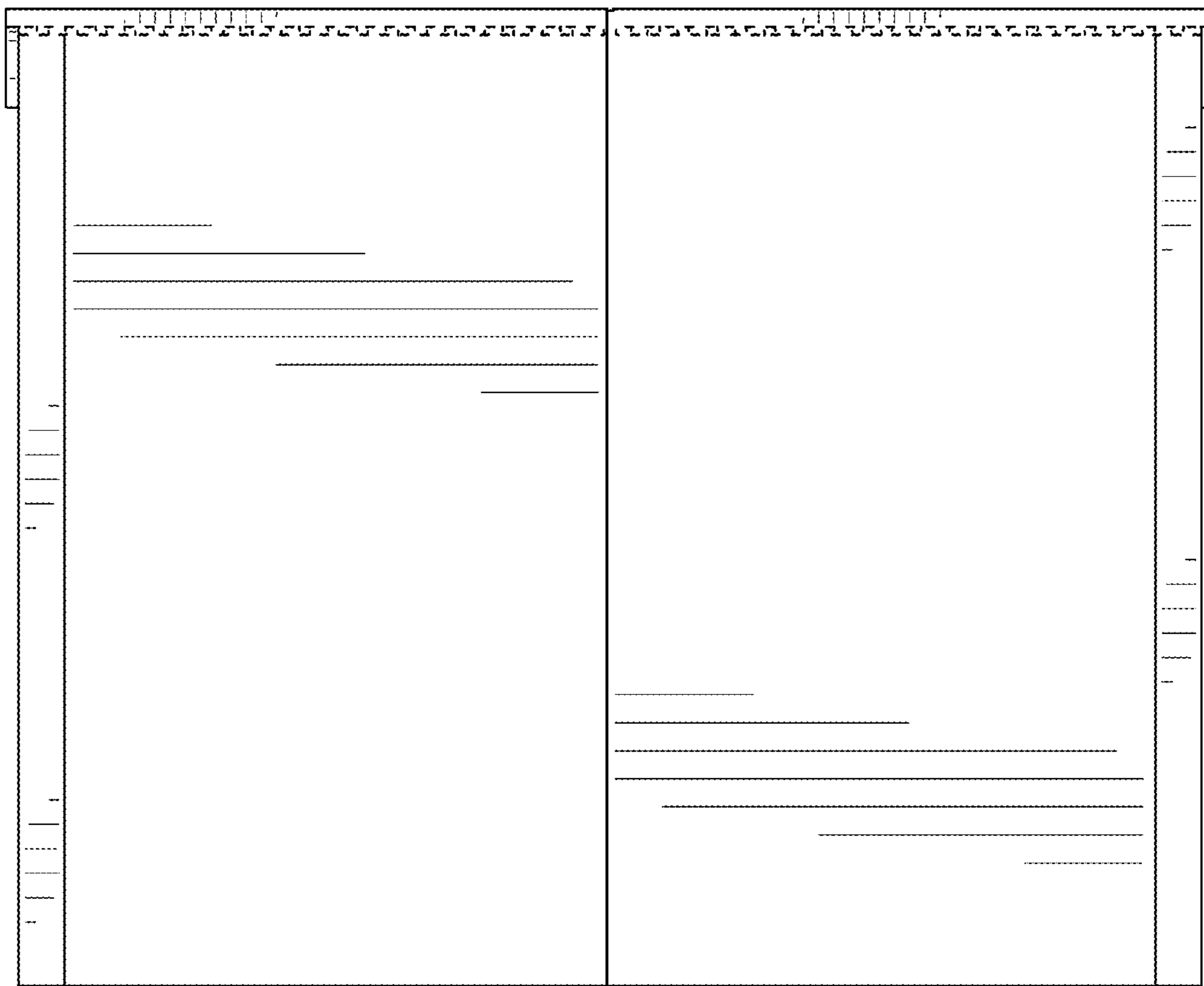

FIG. 14

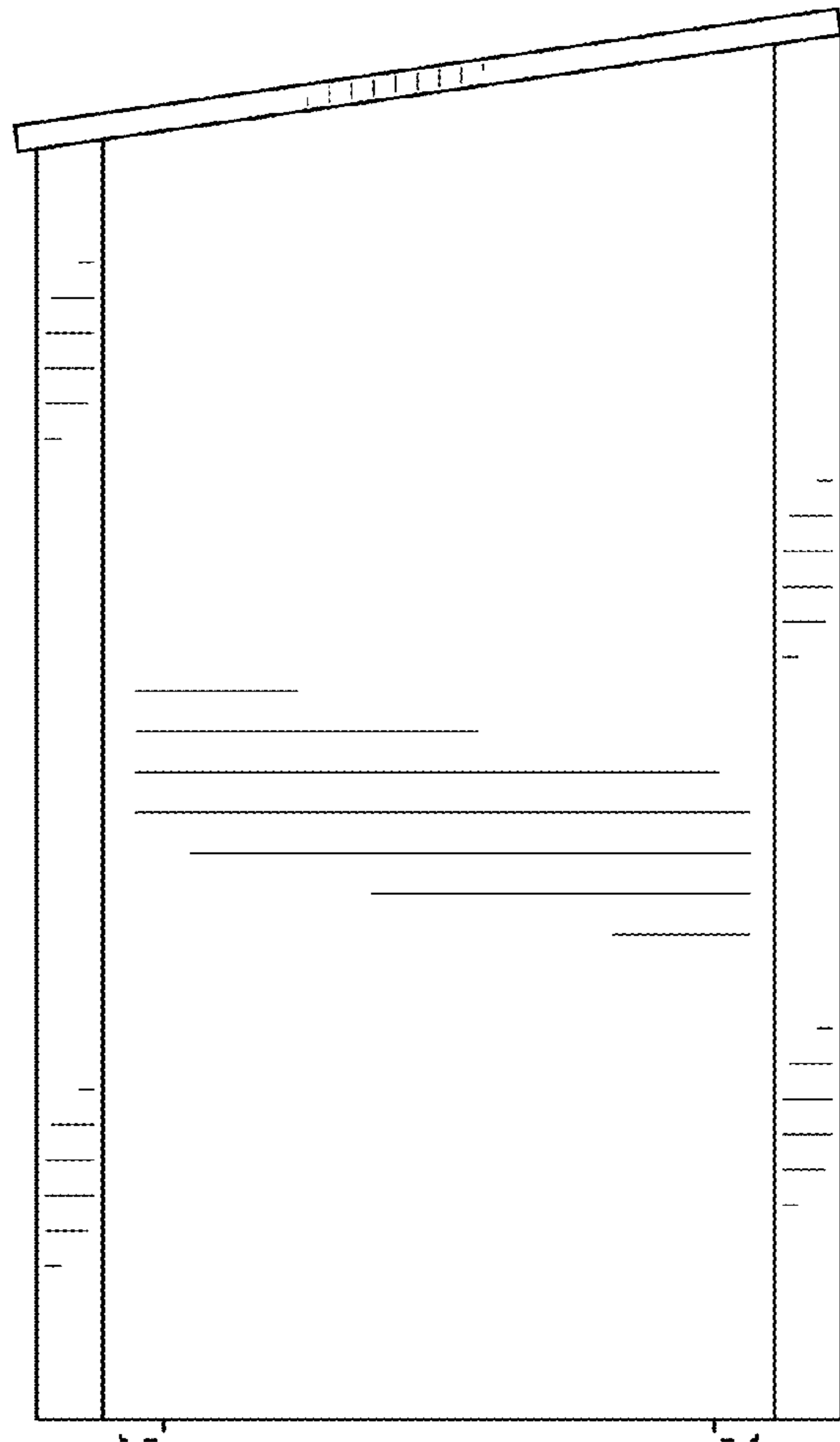

FIG. 15

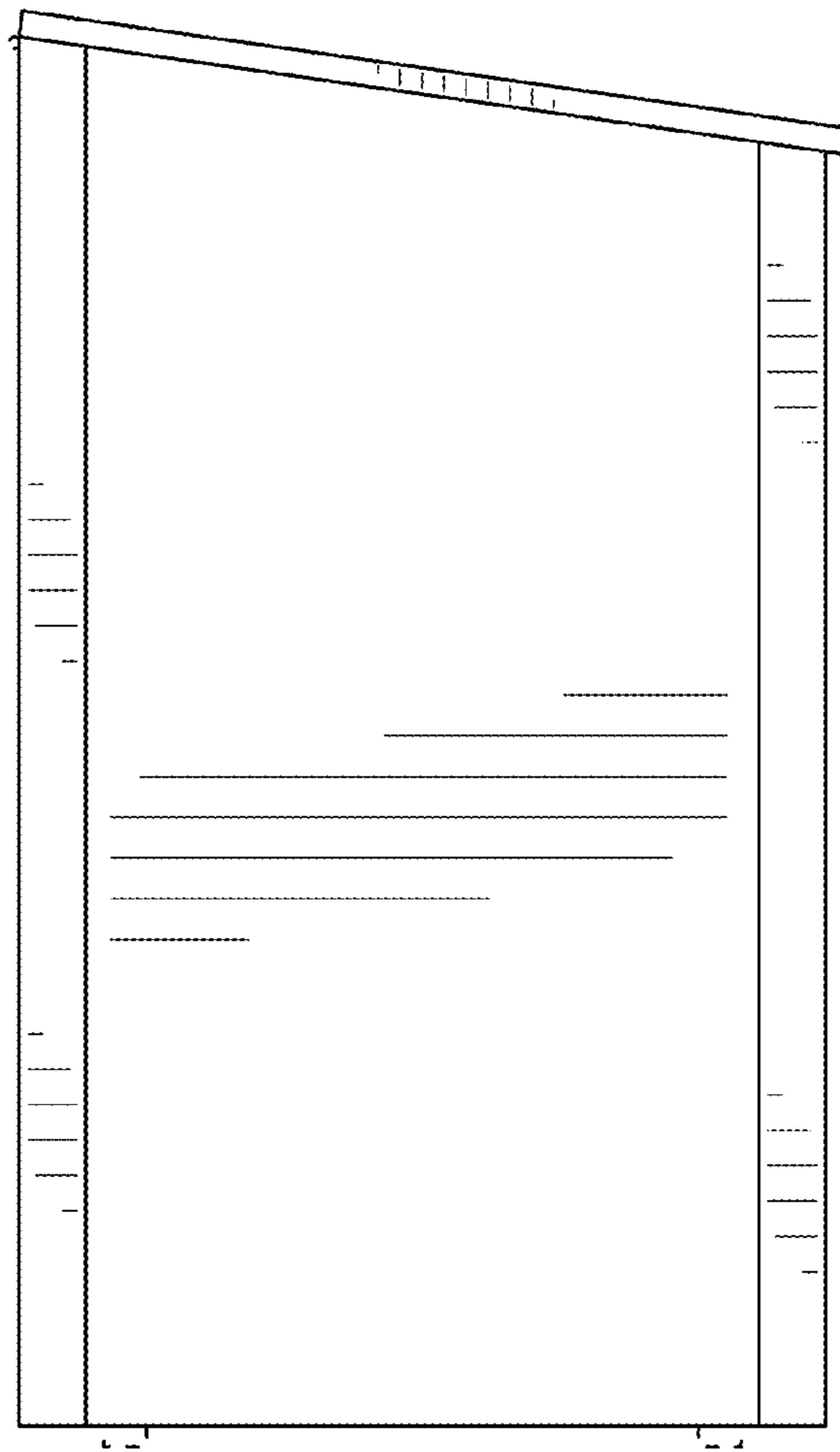

FIG. 16