



US00D738559S

(12) **United States Design Patent**
Epstein

(10) **Patent No.:** **US D738,559 S**
(45) **Date of Patent:** **** Sep. 8, 2015**

(54) **MARBLE LAMP**

D589,203 S * 3/2009 Sabernig D26/104
D654,616 S * 2/2012 Mechanic D26/110
D676,996 S * 2/2013 Gismondi D26/104

(71) Applicant: **Jeffery Noah Epstein**, Cincinnati, OH
(US)

* cited by examiner

(72) Inventor: **Jeffery Noah Epstein**, Cincinnati, OH
(US)

Primary Examiner — Brian N Vinson

(**) Term: **14 Years**

(57) **CLAIM**

The ornamental design for the marble lamp, as shown and described.

(21) Appl. No.: **29/453,015**

(22) Filed: **Apr. 24, 2013**

DESCRIPTION

Related U.S. Application Data

(66) Substitute for application No. 29/429,433, filed on Aug. 10, 2012, now abandoned.

(51) **LOC (10) Cl.** **26-03**

(52) **U.S. Cl.**
USPC **D26/106**

(58) **Field of Classification Search**
USPC D26/24, 93, 106, 108, 110, 112, 104
CPC F21S 6/00; F21S 6/002; F21S 6/004;
F21S 6/008; F21S 8/00; F21S 10/00; F21V
21/02; F21V 2131/30; F21Y 2105/00
See application file for complete search history.

FIG. 1 is a top plan view of a square embodiment of a marble lamp showing my new design;
FIG. 2 is a bottom plan view thereof;
FIG. 3 is a side elevation view thereof, all four sides being identical;
FIG. 4 is a cross-section view thereof taken along a line indicated on FIG. 1;
FIG. 5 is a side elevation view with the only difference from the embodiment portrayed in FIG. 3 being an unclaimed height;
FIG. 6 is a top plan view of a round embodiment of a marble lamp;
FIG. 7 is a bottom plan view thereof;
FIG. 8 is a side elevation view thereof, all side views being identical;
FIG. 9 is a cross-section view thereof taken along a line indicated on FIG. 6; and,
FIG. 10 is a side elevation view with the only difference from the embodiment portrayed in FIG. 3 being an unclaimed height.
Broken lines have been used to show environment and form no part of the claimed design.

(56) **References Cited**

U.S. PATENT DOCUMENTS

D200,172 S * 1/1965 Beck D26/106
D392,407 S * 3/1998 Johnson et al. D26/104
D433,175 S * 10/2000 Basseches D26/112
D475,156 S * 5/2003 Franke D26/104
D480,828 S * 10/2003 Block D26/110
D485,003 S * 1/2004 Olson D26/104
D507,374 S * 7/2005 Chen D26/104

1 Claim, 10 Drawing Sheets

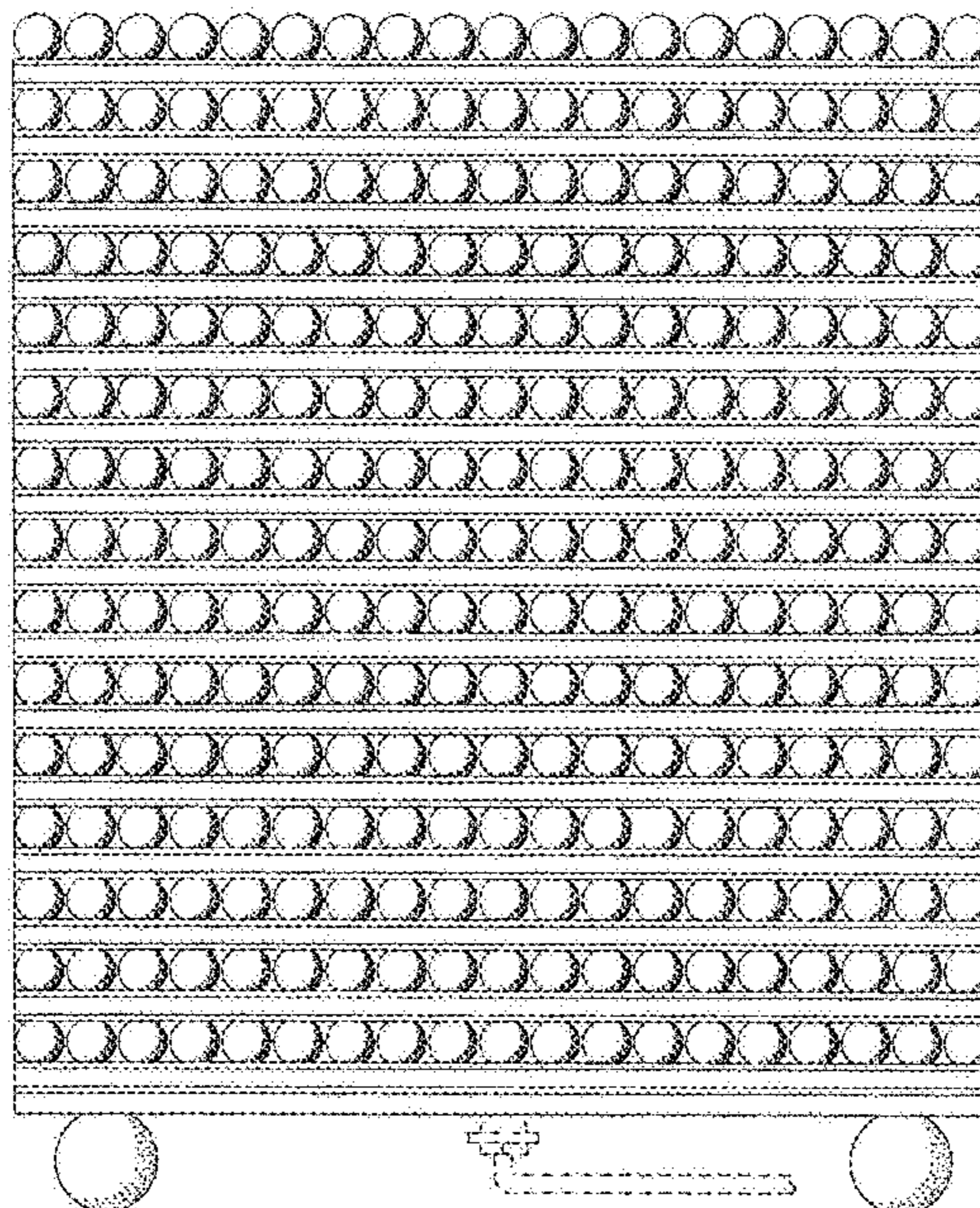

Fig. 1

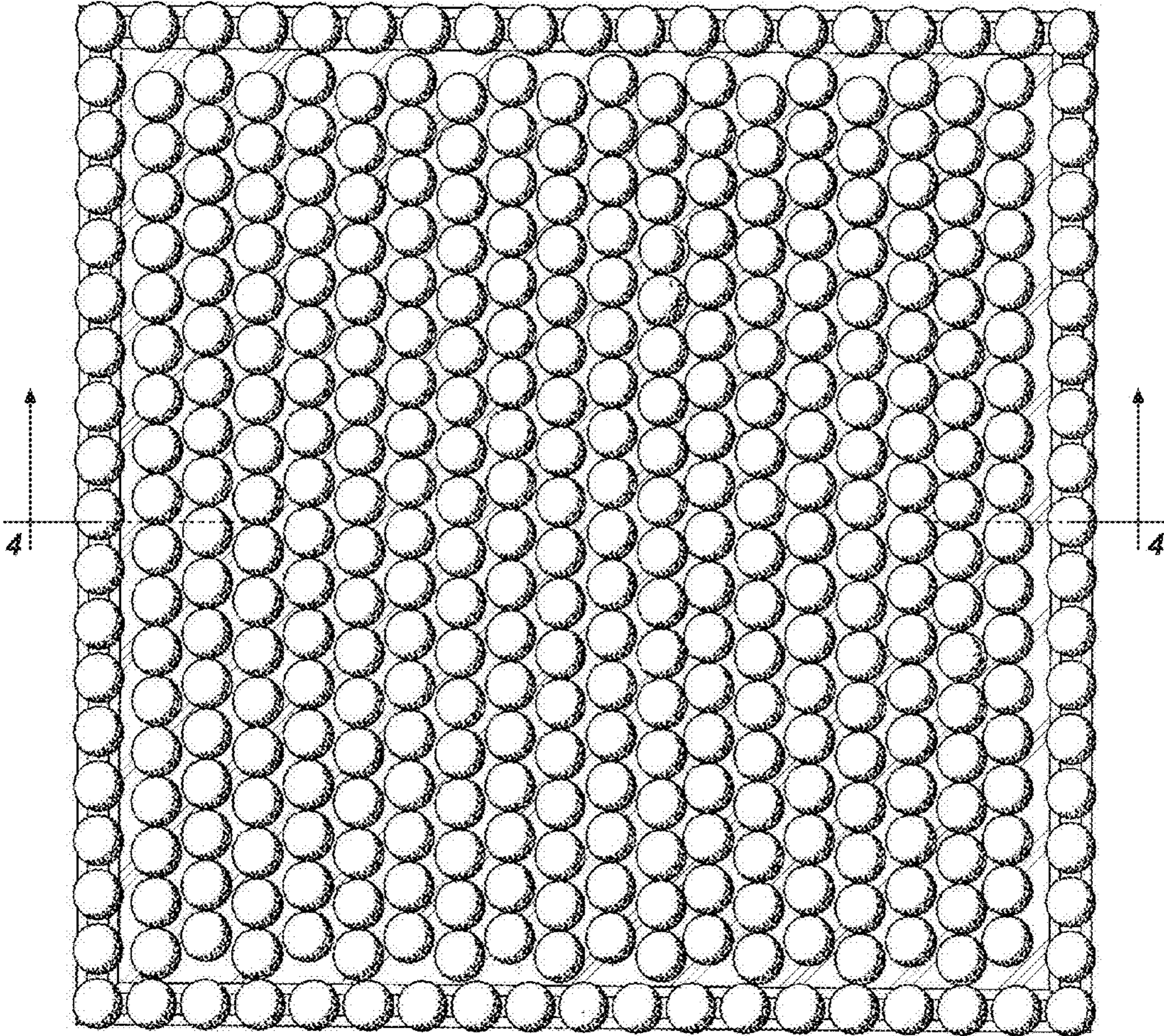

Fig. 2

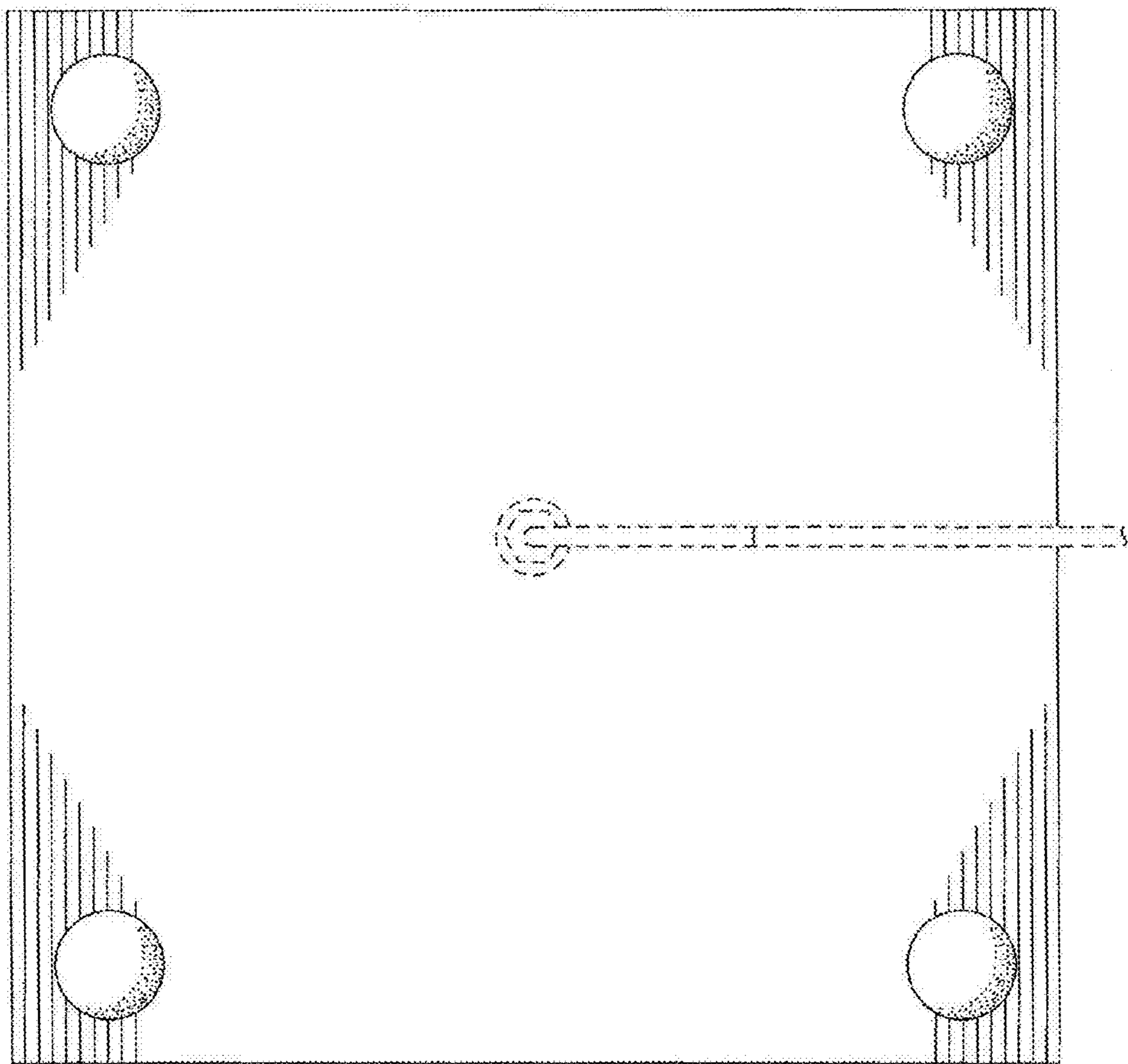

Fig. 3

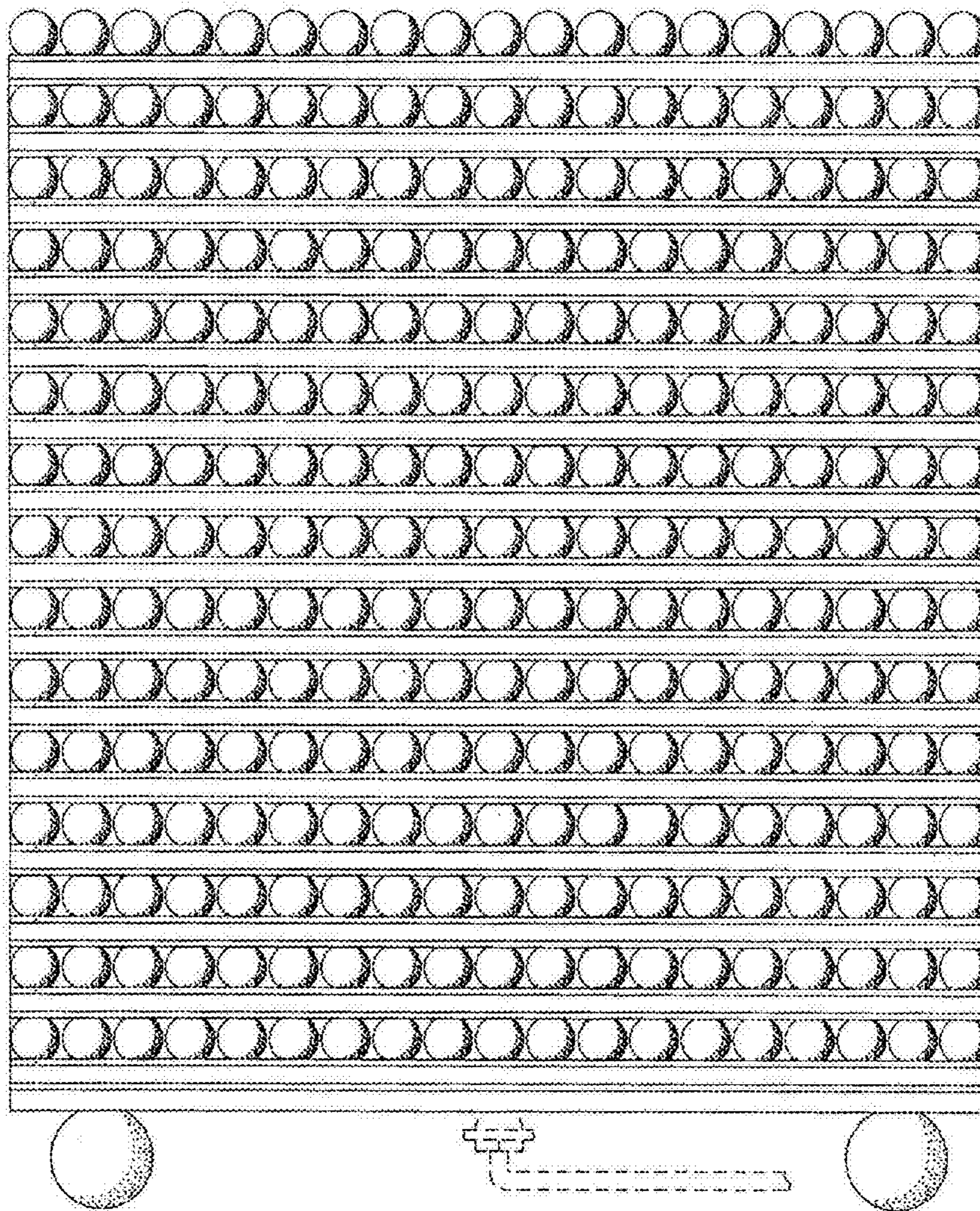

Fig. 4

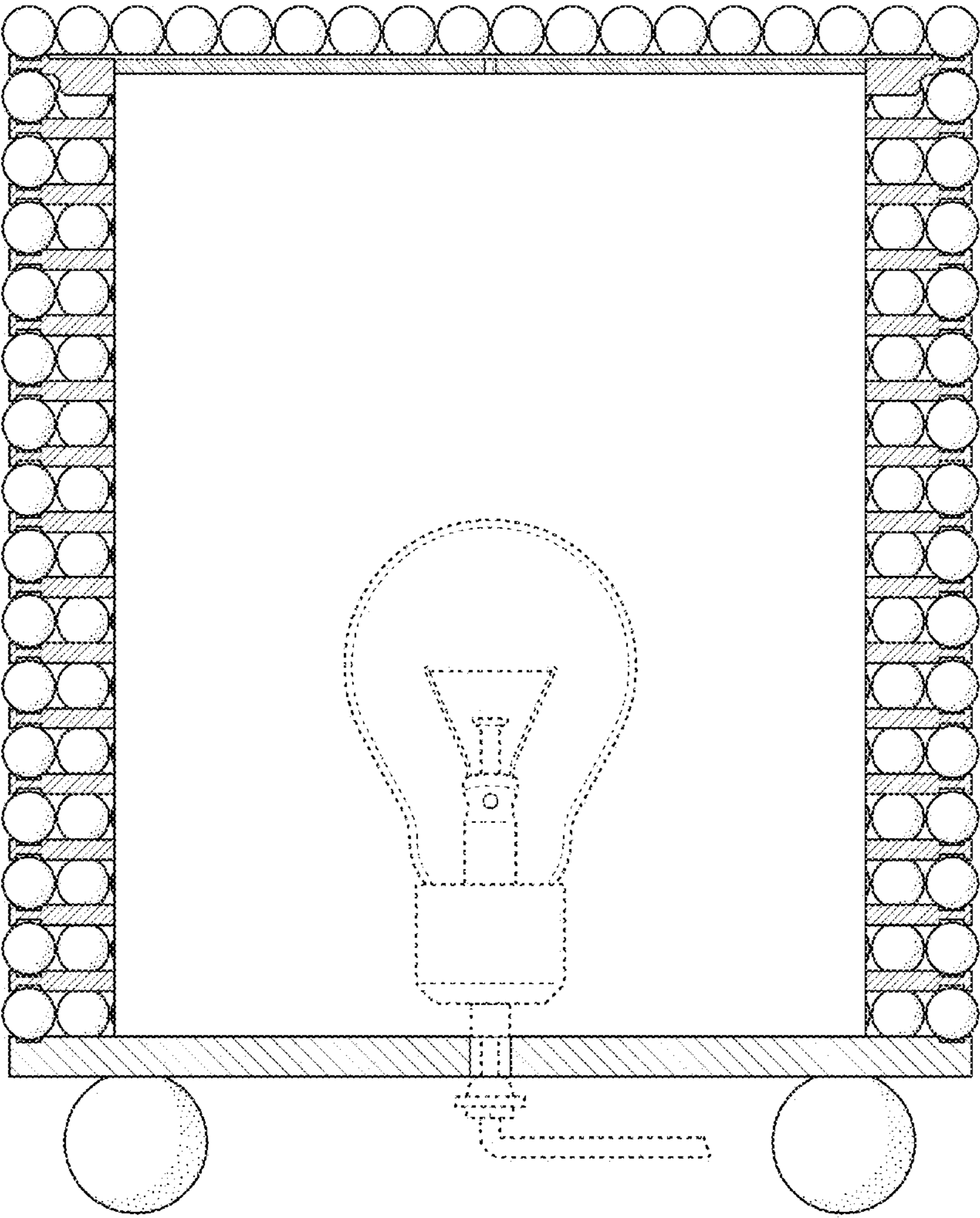

Fig. 5

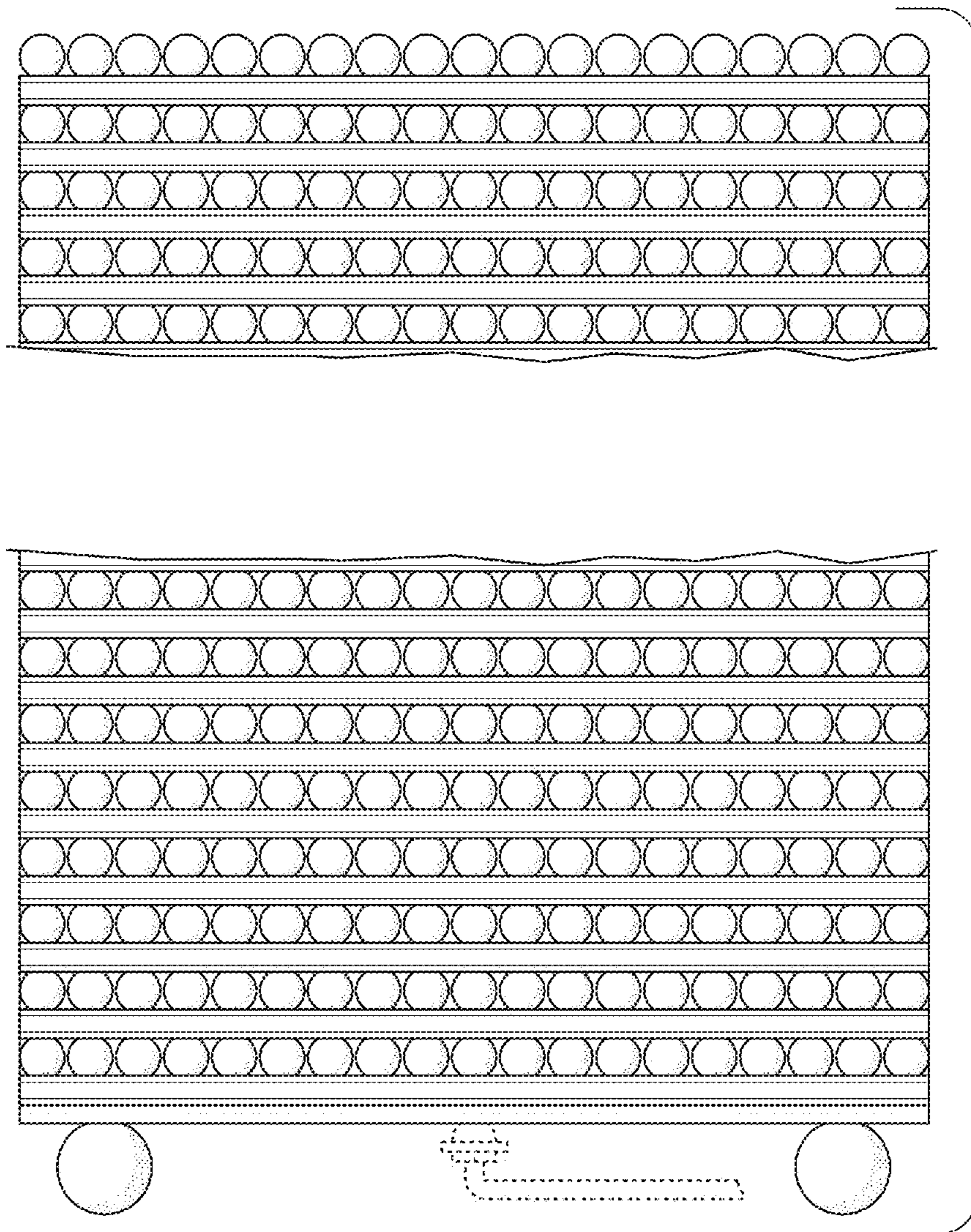

Fig. 6

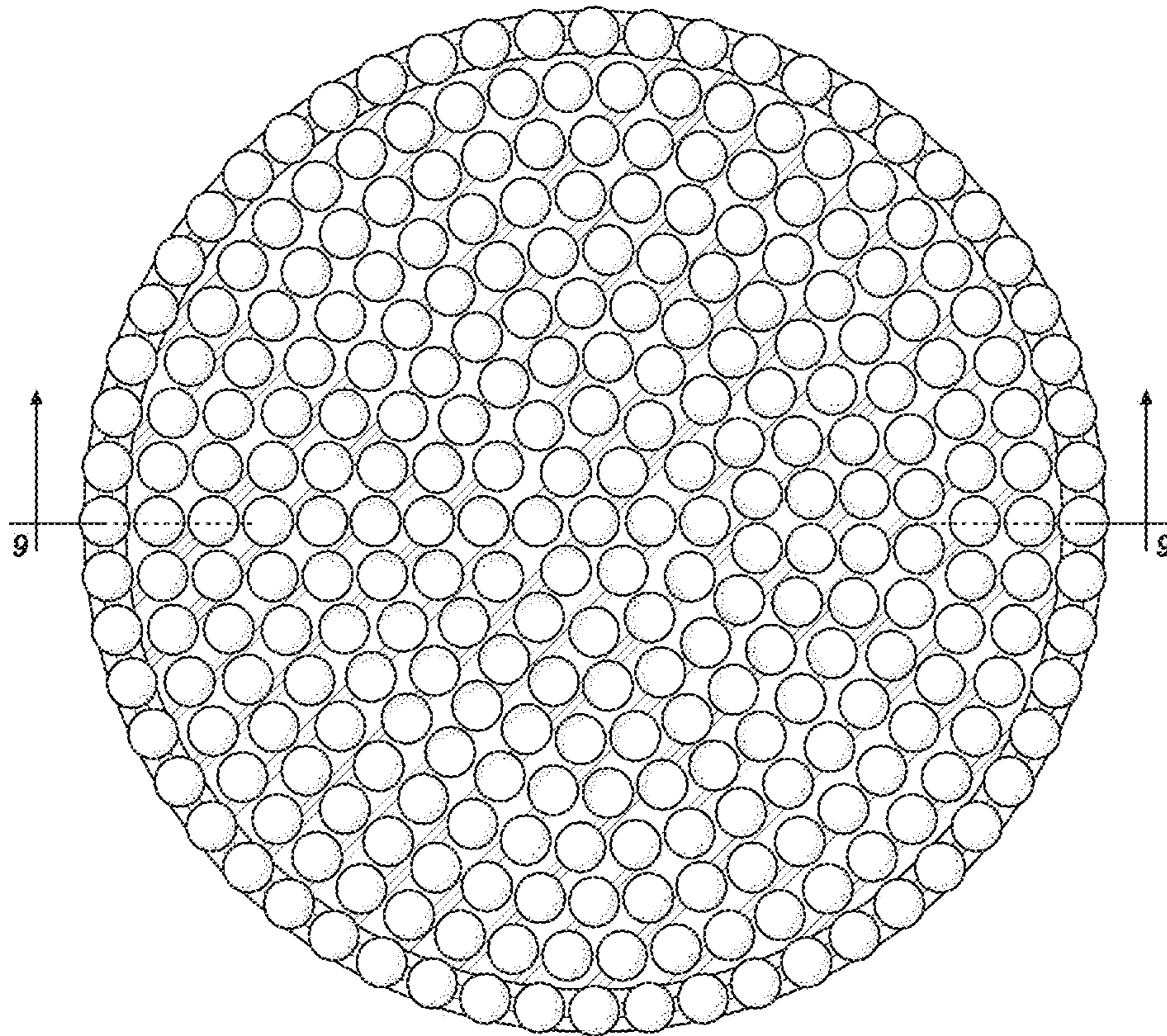

Fig. 7

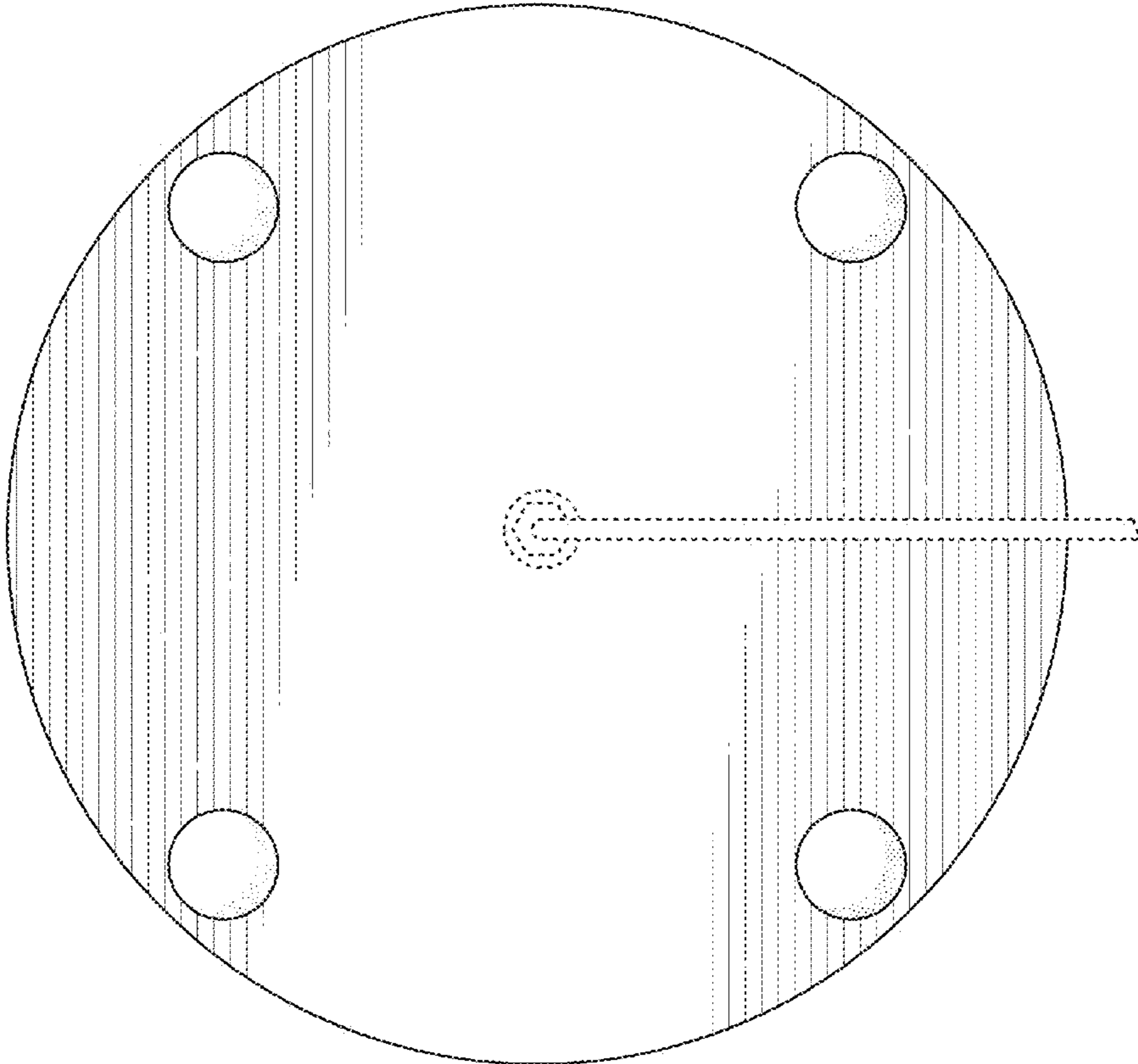

Fig. 8

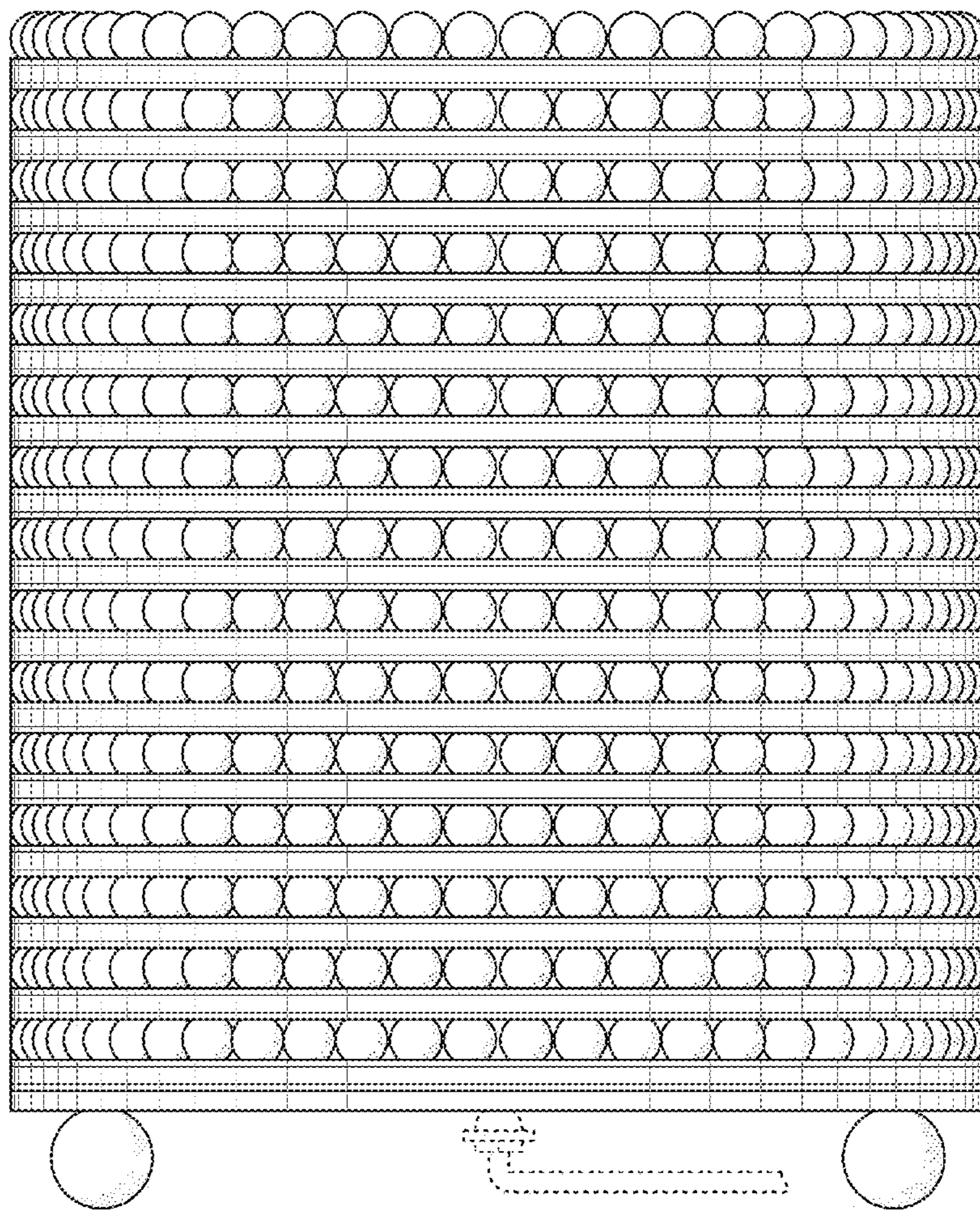

Fig. 9

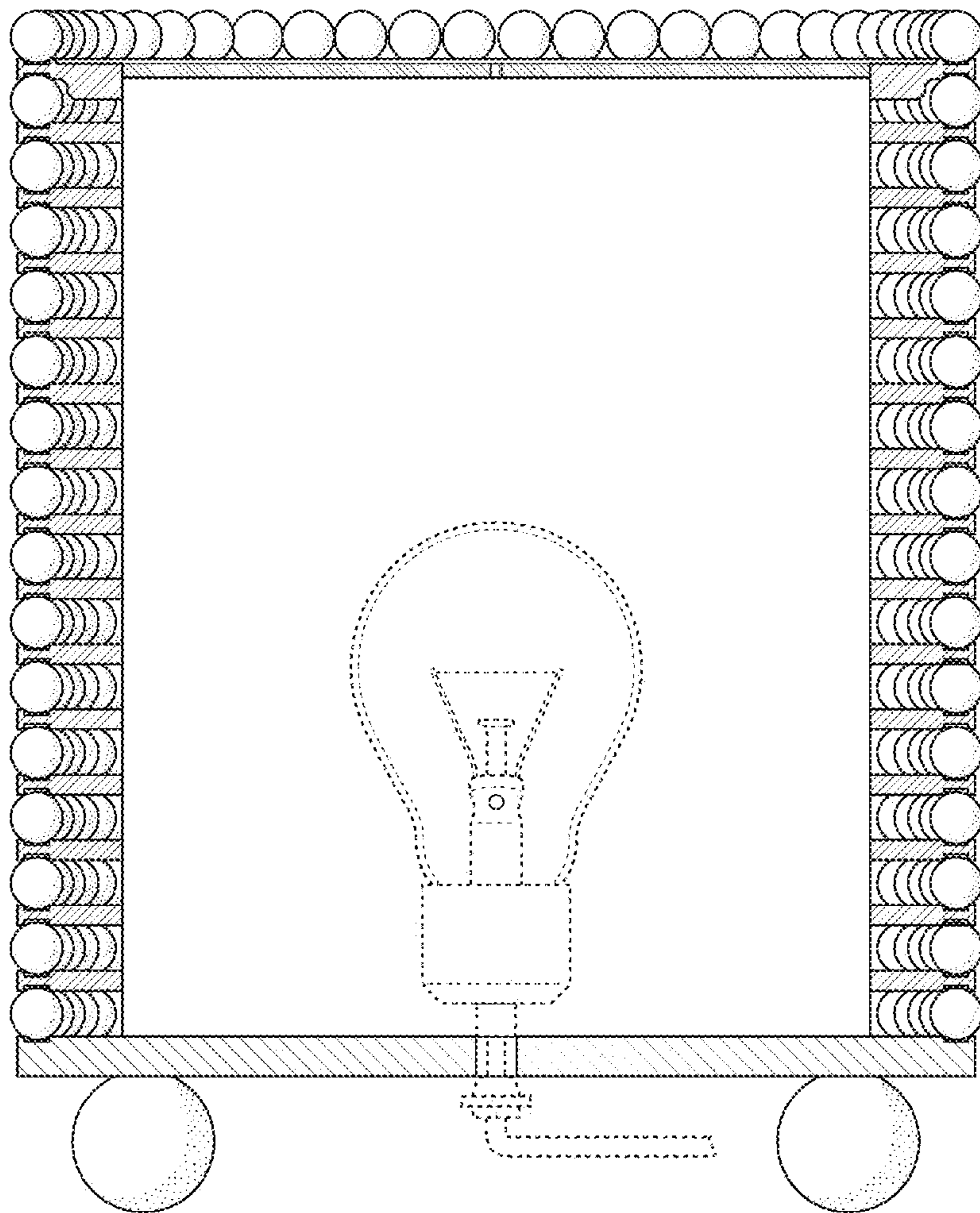

Fig. 10

