



US00D738487S

(12) **United States Design Patent**  
**Anderson et al.**

(10) **Patent No.:** **US D738,487 S**

(45) **Date of Patent:** **\*\* Sep. 8, 2015**

(54) **SUCTION DEVICE FOR NEGATIVE PRESSURE THERAPY**

(71) Applicant: **Mölnlycke Health Care AB**, Göteborg (SE)

(72) Inventors: **Bjarne Anderson**, Frederikssund (DK); **Karsten Videbaek**, Jyllinge (DK)

(73) Assignee: **MOLNLYCKE HEALTH CARE AB** (SE)

(\*\*) Term: **14 Years**

(21) Appl. No.: **29/458,769**

(22) Filed: **Jun. 21, 2013**

(30) **Foreign Application Priority Data**

Jan. 28, 2013	(EM)	002173476-0001
Jan. 28, 2013	(EM)	002173476-0002
Jan. 28, 2013	(EM)	002173476-0003
Jan. 28, 2013	(EM)	002173476-0004
Jan. 28, 2013	(EM)	002173476-0005

(51) **LOC (10) Cl.** ..... **24-01**

(52) **U.S. Cl.**  
USPC ..... **D24/108**

(58) **Field of Classification Search**  
USPC ..... D24/107, 108, 127, 129, 188; 604/213, 604/313, 315, 316, 319, 540, 543  
See application file for complete search history.

(56) **References Cited**

**U.S. PATENT DOCUMENTS**

4,645,492	A *	2/1987	Weeks	604/174
4,778,446	A	10/1988	Jensen	
6,179,804	B1 *	1/2001	Satterfield	604/23
6,685,681	B2 *	2/2004	Lockwood et al.	604/305
7,276,051	B1 *	10/2007	Henley et al.	604/304
7,534,927	B2 *	5/2009	Lockwood et al.	602/46
7,651,484	B2 *	1/2010	Heaton et al.	604/313
7,776,028	B2 *	8/2010	Miller et al.	604/543

8,007,491	B2 *	8/2011	Pinto et al.	604/540
8,057,447	B2 *	11/2011	Olson et al.	604/313
D659,824	S *	5/2012	Kwok	D24/113
8,241,260	B2 *	8/2012	Livne et al.	604/305
8,308,703	B2 *	11/2012	Heaton et al.	604/304
8,439,882	B2 *	5/2013	Kelch	604/313
8,449,509	B2 *	5/2013	Weston	604/313
8,460,255	B2 *	6/2013	Joshi et al.	604/313
8,529,528	B2 *	9/2013	Robinson et al.	604/313
D691,730	S *	10/2013	Smith et al.	D24/189
D699,839	S *	2/2014	Voic	D24/127
8,708,984	B2 *	4/2014	Robinson et al.	604/319
8,728,045	B2 *	5/2014	Hu et al.	604/319
8,734,410	B2 *	5/2014	Hall et al.	604/319
8,771,244	B2 *	7/2014	Eckstein et al.	604/315

(Continued)

**FOREIGN PATENT DOCUMENTS**

GB	1549756	A	8/1979
WO	WO-2014/114804	A1	7/2014

*Primary Examiner* — Deanna L Pratt

*Assistant Examiner* — Lilyana Bekic

(74) *Attorney, Agent, or Firm* — Choate, Hall & Stewart LLP; Charles E. Lyon

(57) **CLAIM**

The ornamental design for a suction device for negative pressure therapy, as shown and described.

**DESCRIPTION**

FIG. 1 is a perspective view of a suction device for negative pressure therapy showing my new design;  
FIG. 2 is a top thereof;  
FIG. 3 is a bottom view thereof;  
FIG. 4 is a front view thereof;  
FIG. 5 is a rear view thereof;  
FIG. 6 is a right side view thereof; and,  
FIG. 7 is a left side view thereof.  
The broken lines depict portions of the suction device for negative pressure therapy that form no part of the claimed design.

**1 Claim, 5 Drawing Sheets**

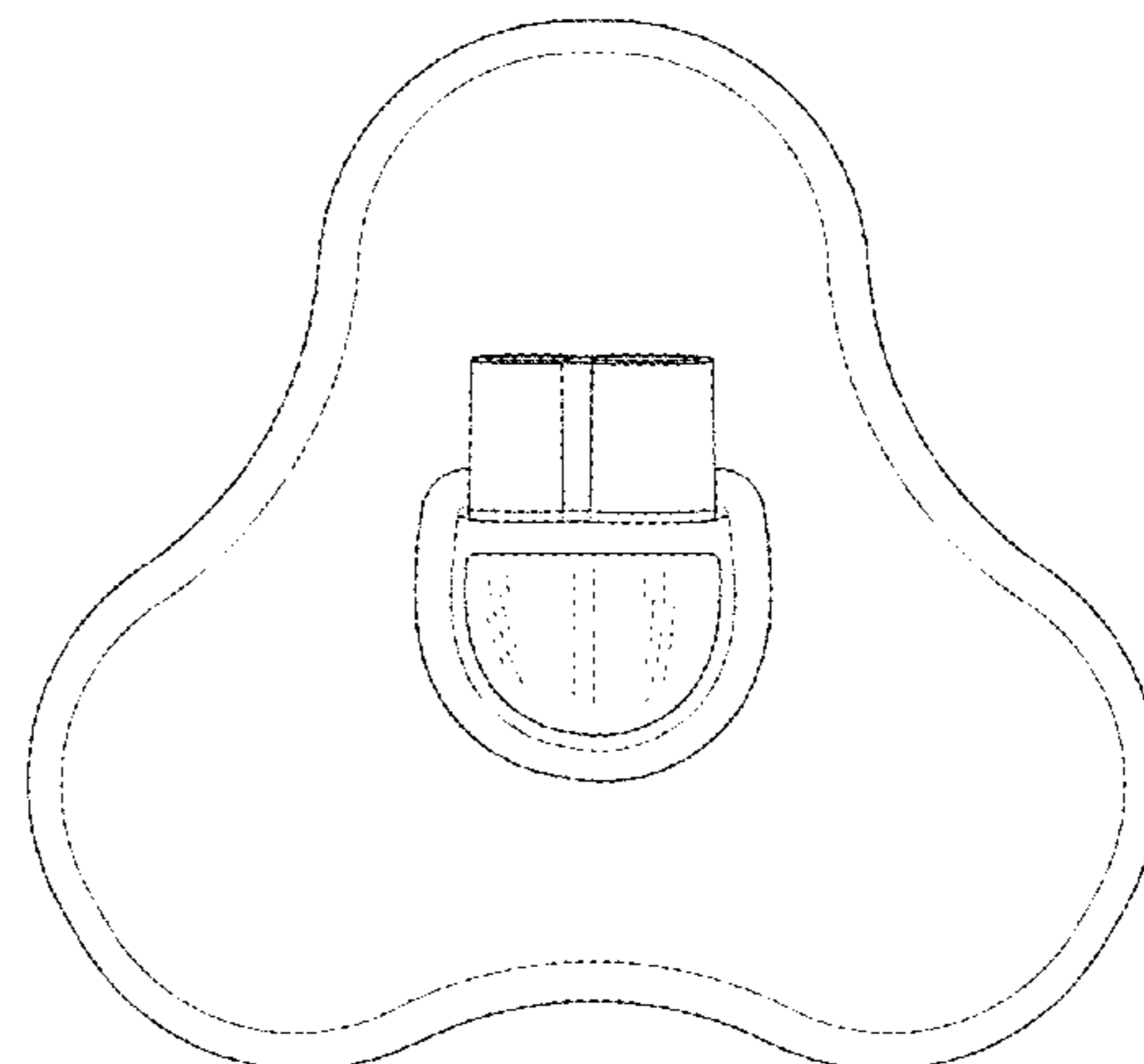
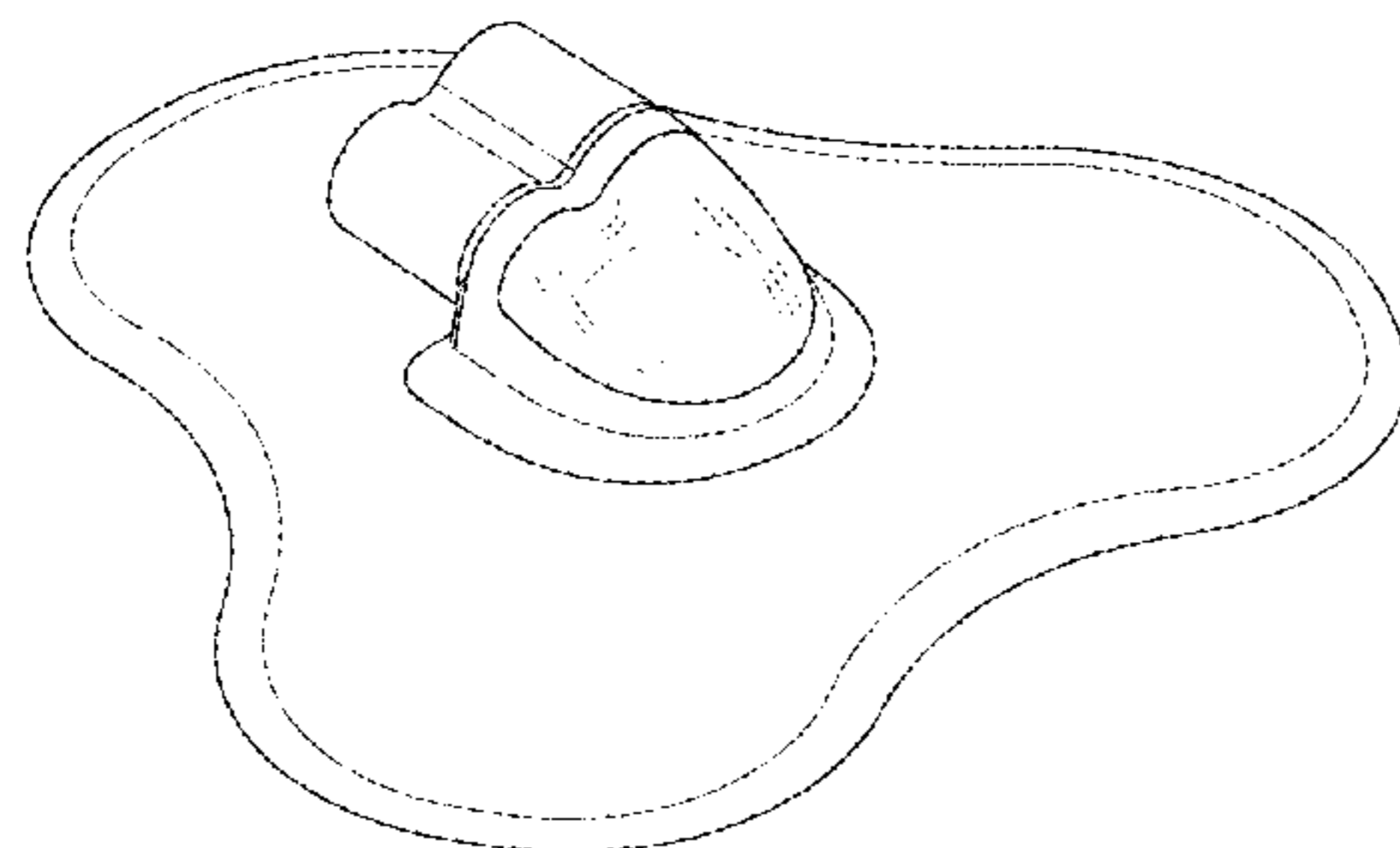

(56)

**References Cited**

U.S. PATENT DOCUMENTS

8,795,243	B2 *	8/2014	Weston .....	604/313	2008/0275409	A1	11/2008	Kane et al.	
8,864,748	B2 *	10/2014	Coulthard et al. ....	604/543	2008/0306456	A1 *	12/2008	Riesinger .....	604/316
2006/0173253	A1	8/2006	Ganapathy et al.		2010/0324510	A1 *	12/2010	Andresen et al. ....	604/319
					2011/0004172	A1 *	1/2011	Eckstein et al. ....	604/313
					2012/0010578	A1	1/2012	Hirsch	

\* cited by examiner

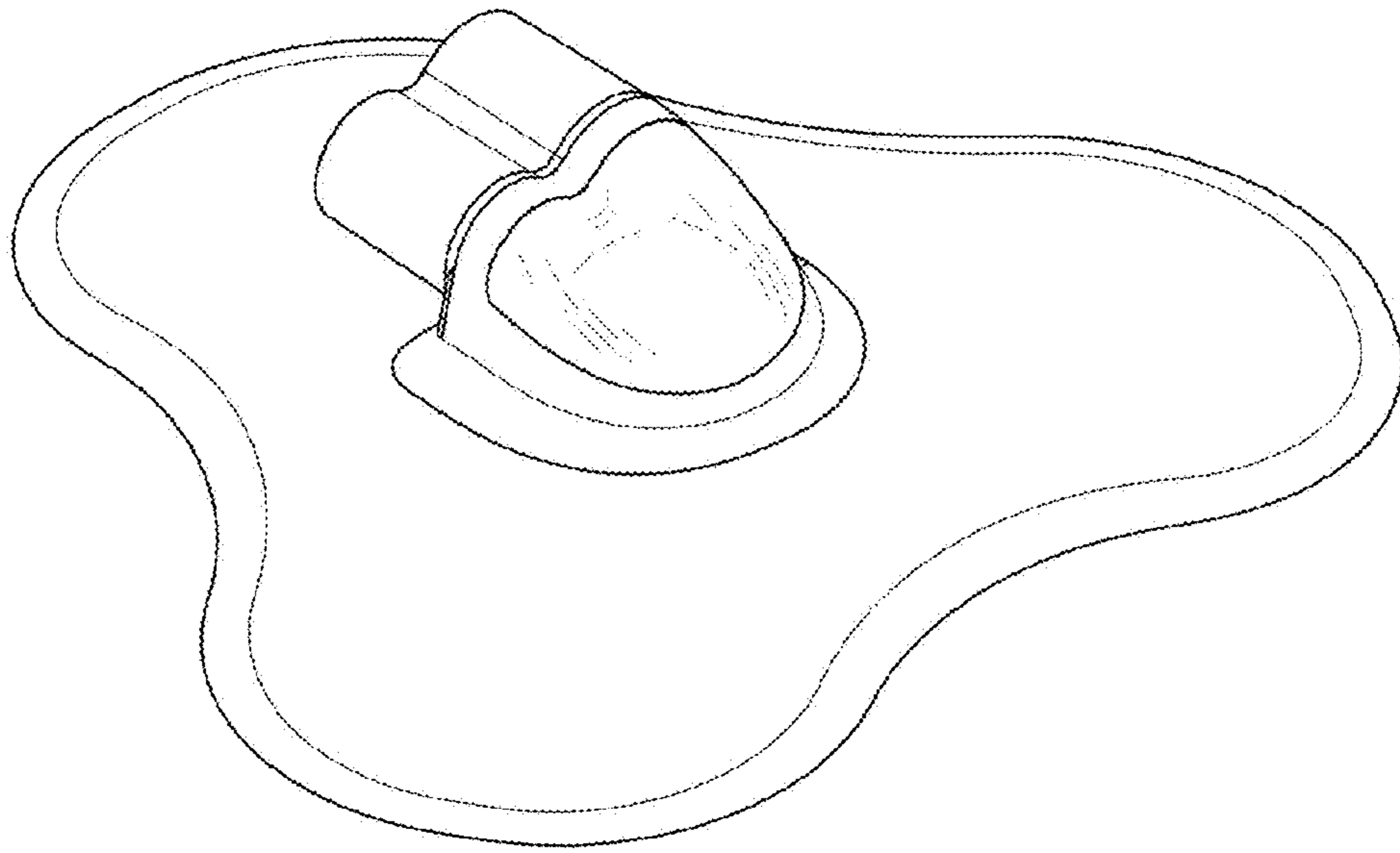

FIG. 1

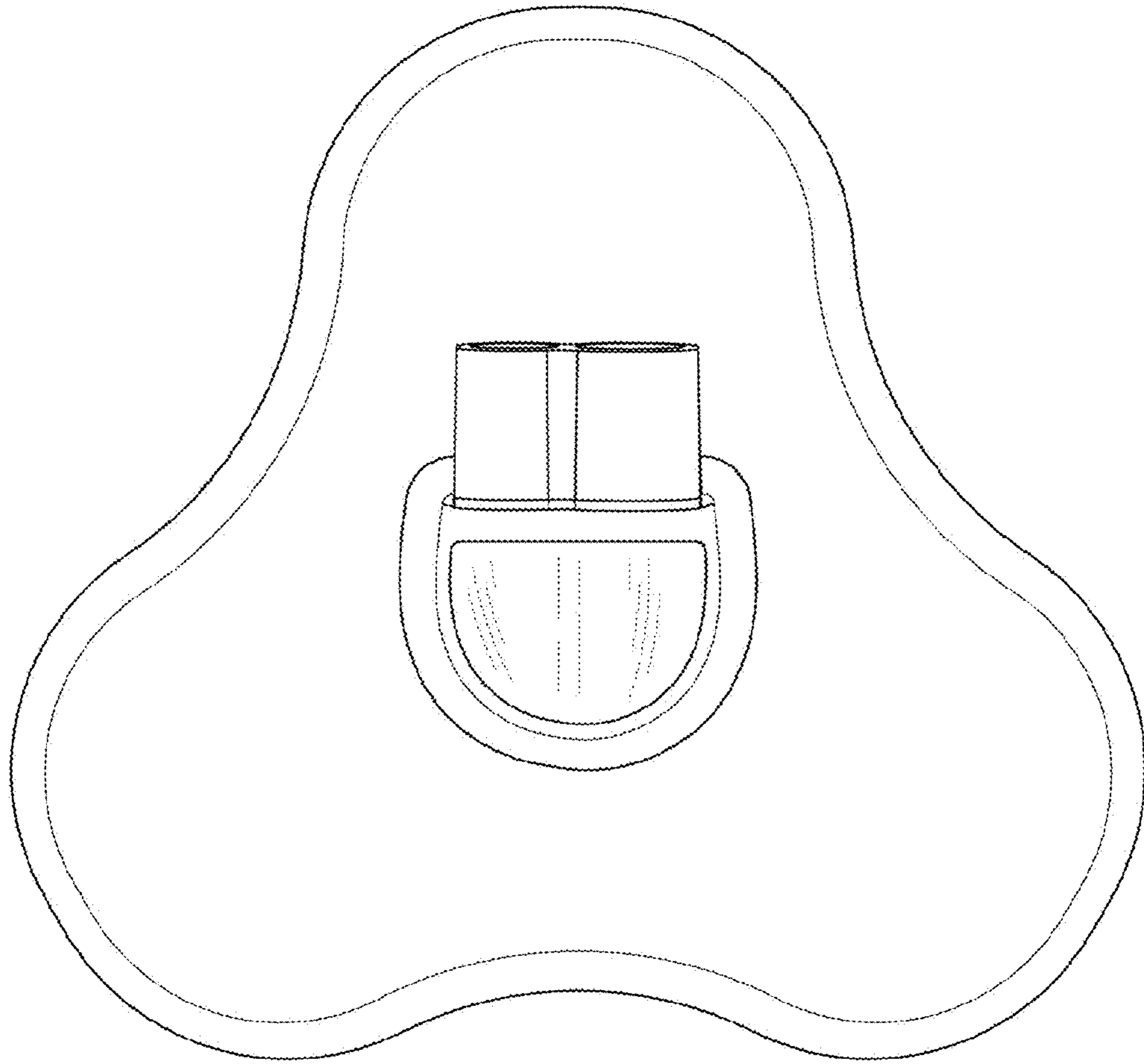

FIG. 2

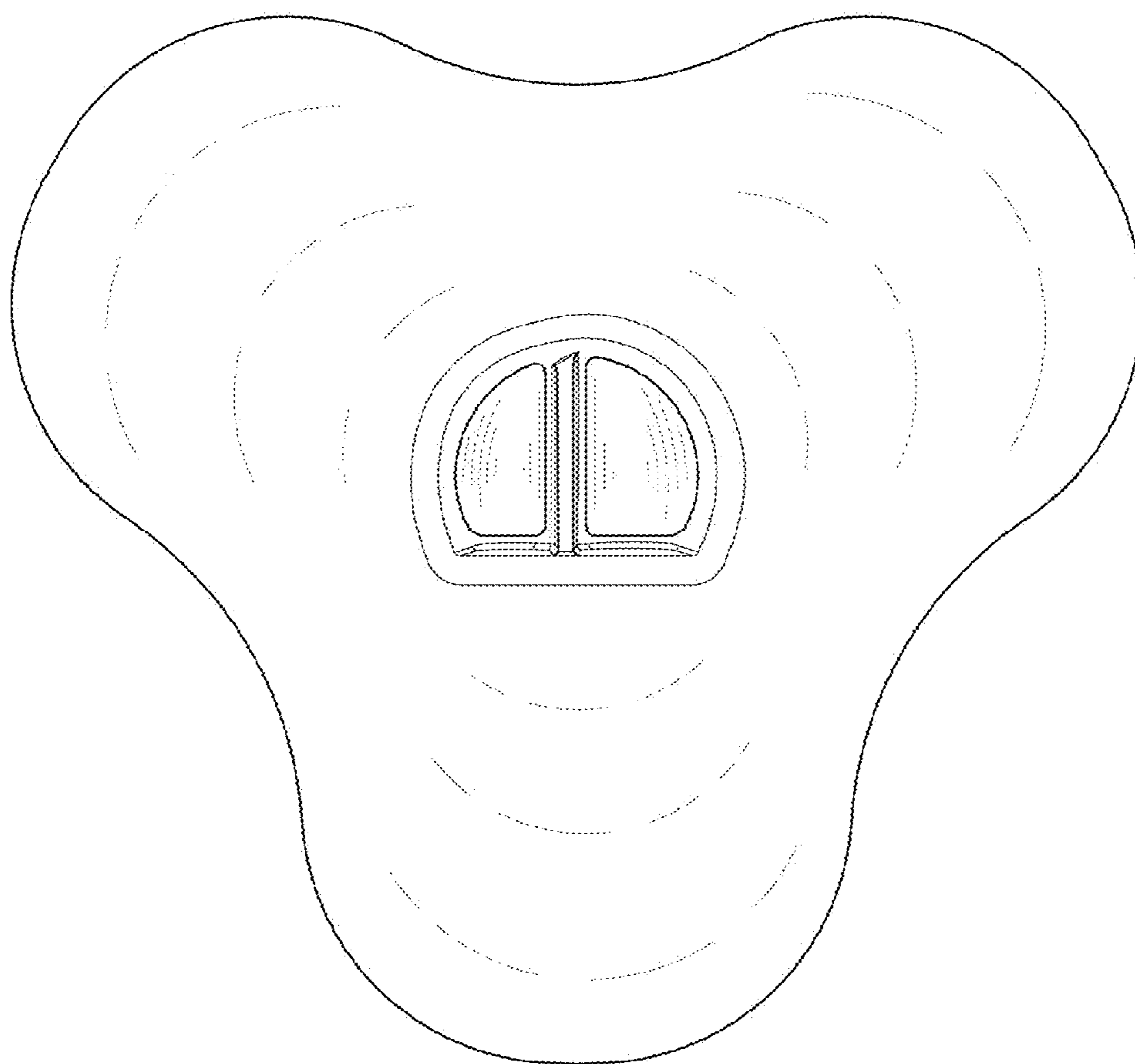

FIG. 3

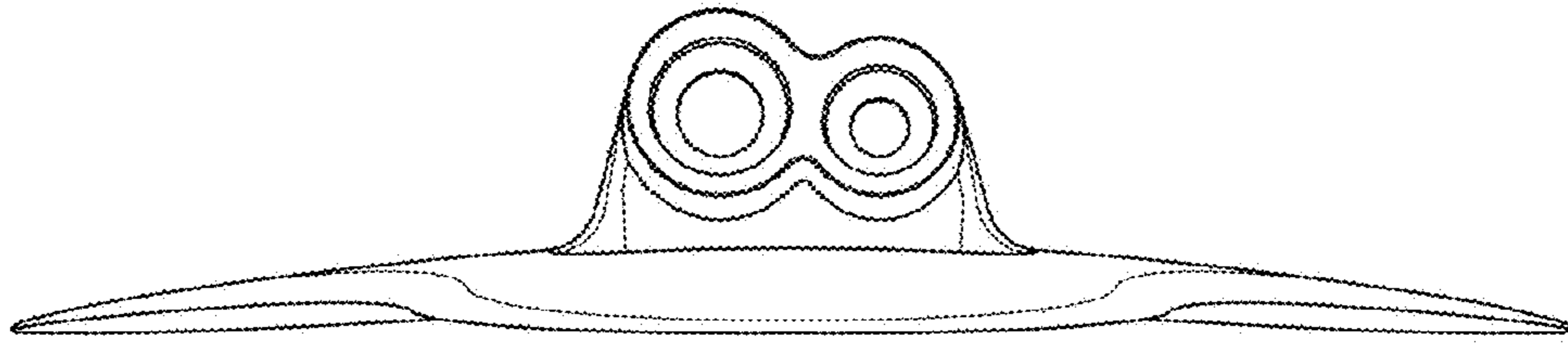

FIG. 4

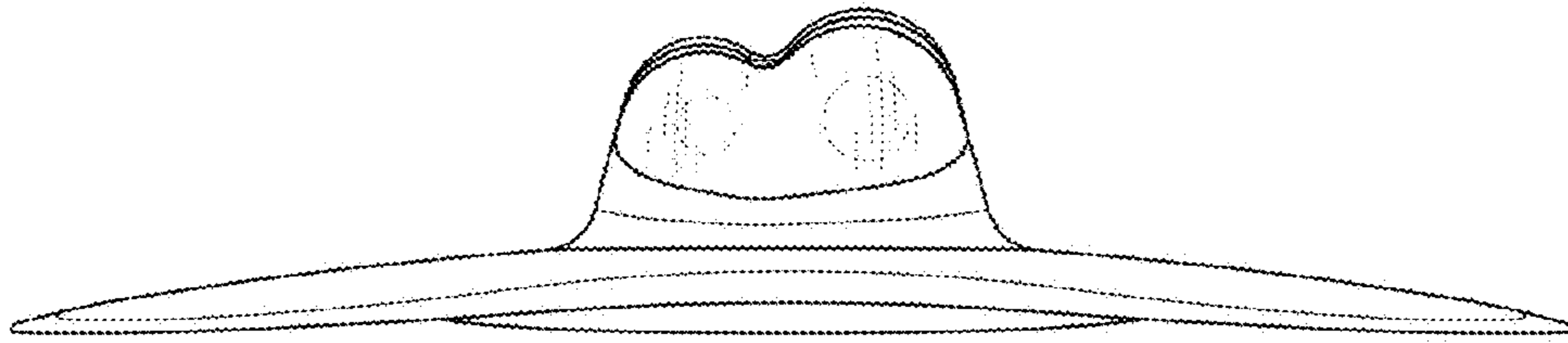

FIG. 5

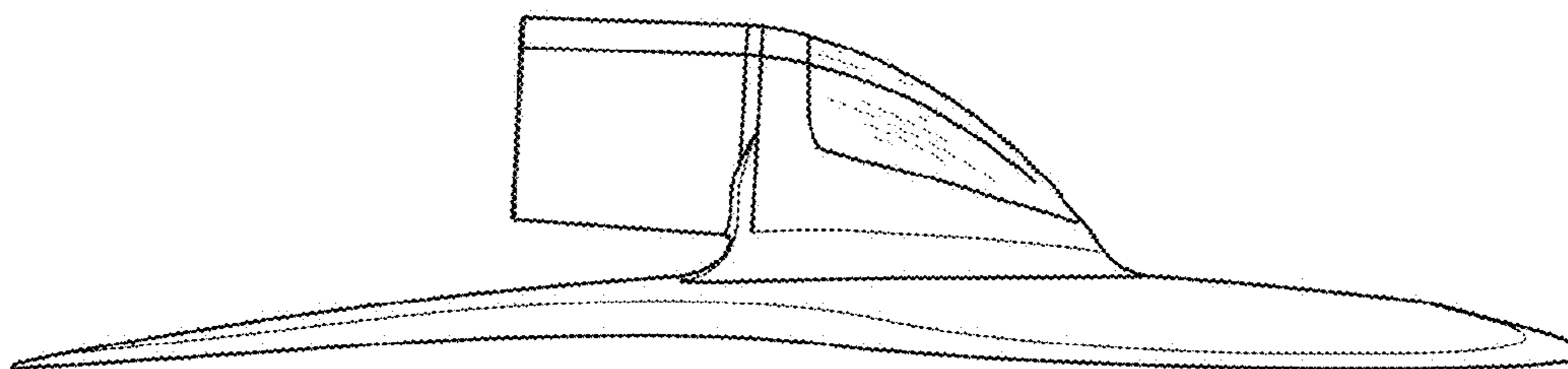

FIG. 6

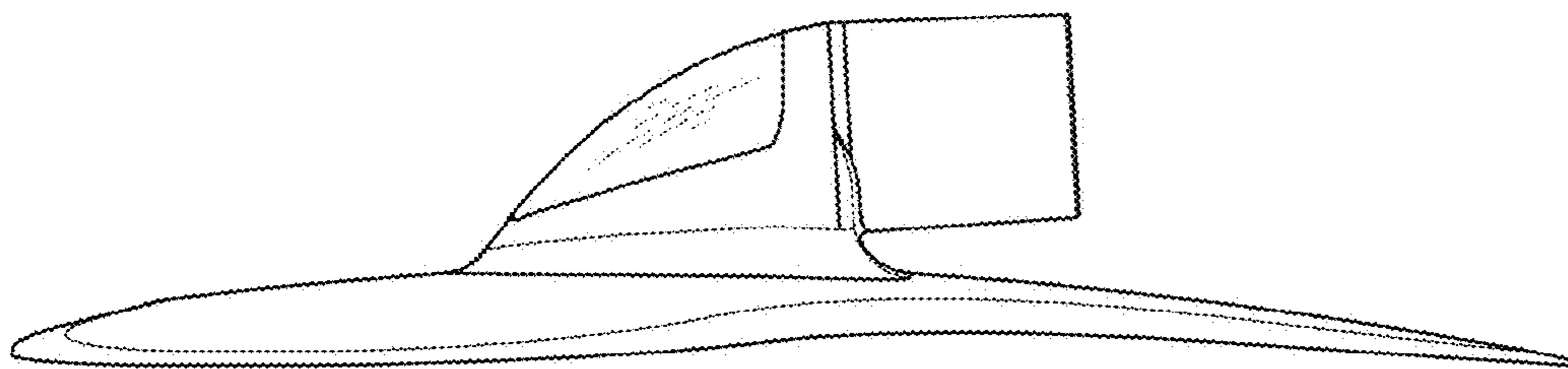

FIG. 7