



US00D738480S

(12) **United States Design Patent**  
**Jacobs et al.**

(10) **Patent No.:** **US D738,480 S**  
(45) **Date of Patent:** **\*\* Sep. 8, 2015**

(54) **DEODORIZER**

(71) Applicant: **Remodeez LLC**, Charlotte, NC (US)

(72) Inventors: **Jason D. Jacobs**, Charlotte, NC (US);  
**Scott Newlin**, Brooklyn, NY (US)

(73) Assignee: **Remodeez LLC**, Charlotte, NC (US)

(\*\*) Term: **14 Years**

(21) Appl. No.: **29/519,780**

(22) Filed: **Mar. 8, 2015**

**Related U.S. Application Data**

(63) Continuation-in-part of application No. 29/502,156,  
filed on Sep. 12, 2014, now abandoned.

(51) **LOC (10) Cl.** ..... **28-99**

(52) **U.S. Cl.**  
USPC ..... **D23/366**

(58) **Field of Classification Search**  
USPC ..... D23/355-369; D28/5, 6; 261/DIG. 17,  
261/DIG. 42, DIG. 65, DIG. 88, DIG. 89;  
392/386, 390, 394, 395, 397; 239/34,  
239/44, 53, 55, 56, 326; D26/9, 10;  
D11/131.1

See application file for complete search history.

(56) **References Cited**

**U.S. PATENT DOCUMENTS**

1,769,409 A	7/1930	Armstrong
D162,679 S	3/1951	Munnecke
D175,254 S	8/1955	Hanson
2,738,225 A	3/1956	Meek
3,797,982 A	3/1974	Borrello
D244,200 S	5/1977	Ramos et al.
4,612,223 A	9/1986	Spector
D357,330 S	4/1995	Wong et al.
D411,881 S	7/1999	Weick
D445,493 S	7/2001	Nystrom
D451,183 S	11/2001	Hirano et al.
D462,431 S	9/2002	Bunce et al.
D496,451 S	9/2004	Julos et al.
D503,468 S	3/2005	Harbutt et al.

D509,578 S	9/2005	Yao	
D510,422 S	10/2005	Schriner et al.	
D532,695 S	11/2006	Grant	
D548,317 S	8/2007	Newton et al.	
D560,788 S	1/2008	Farrell et al.	
D575,384 S	8/2008	Huang	
D582,533 S	12/2008	Bodine	
D582,534 S	12/2008	Conway et al.	
D591,415 S	4/2009	Wu	
D593,669 S	6/2009	Daelemans et al.	
D596,281 S *	7/2009	Schwartz et al.	..... D23/366
D609,322 S *	2/2010	Schwartz et al.	..... D23/366
D611,581 S	3/2010	Jorgensen	
D614,278 S *	4/2010	Schwartz et al.	..... D23/366
D622,400 S *	8/2010	Freeman et al.	..... D24/186
D629,881 S	12/2010	Valentino et al.	
D633,191 S	2/2011	Sato	
D654,761 S	2/2012	Herbst	
D675,304 S	1/2013	Valentino et al.	
D681,182 S	4/2013	Tomas Vilarasa et al.	
D681,183 S	4/2013	Blanchford et al.	
D713,948 S *	9/2014	Westphal	..... D23/366
D716,434 S	10/2014	Newlin	
2008/0253755 A1	10/2008	Smith et al.	

**OTHER PUBLICATIONS**

Notice of Allowance for Design U.S. Appl. No. 29/502,156, Dec. 8,  
2014, 13 pages.

European Community Design Registration Nos. 002538272-0001  
through 0007, Sep. 15, 2014.

Snapp, Sandra S., U.S. Appl. No. 29/484,963, Office Action 1, Jul. 8,  
2015, 20 pages.

\* cited by examiner

*Primary Examiner* — Sandra Snapp

(74) *Attorney, Agent, or Firm* — LaBatt, LLC

(57) **CLAIM**

The ornamental design for a deodorizer, as shown and  
described.

**DESCRIPTION**

FIG. 1 is a front, left side perspective view of a first embodi-  
ment of a deodorizer according to the present design.

FIG. 2 is a front elevation view of the deodorizer shown in  
FIG. 1, the rear elevation view is identical to the front eleva-  
tion view.

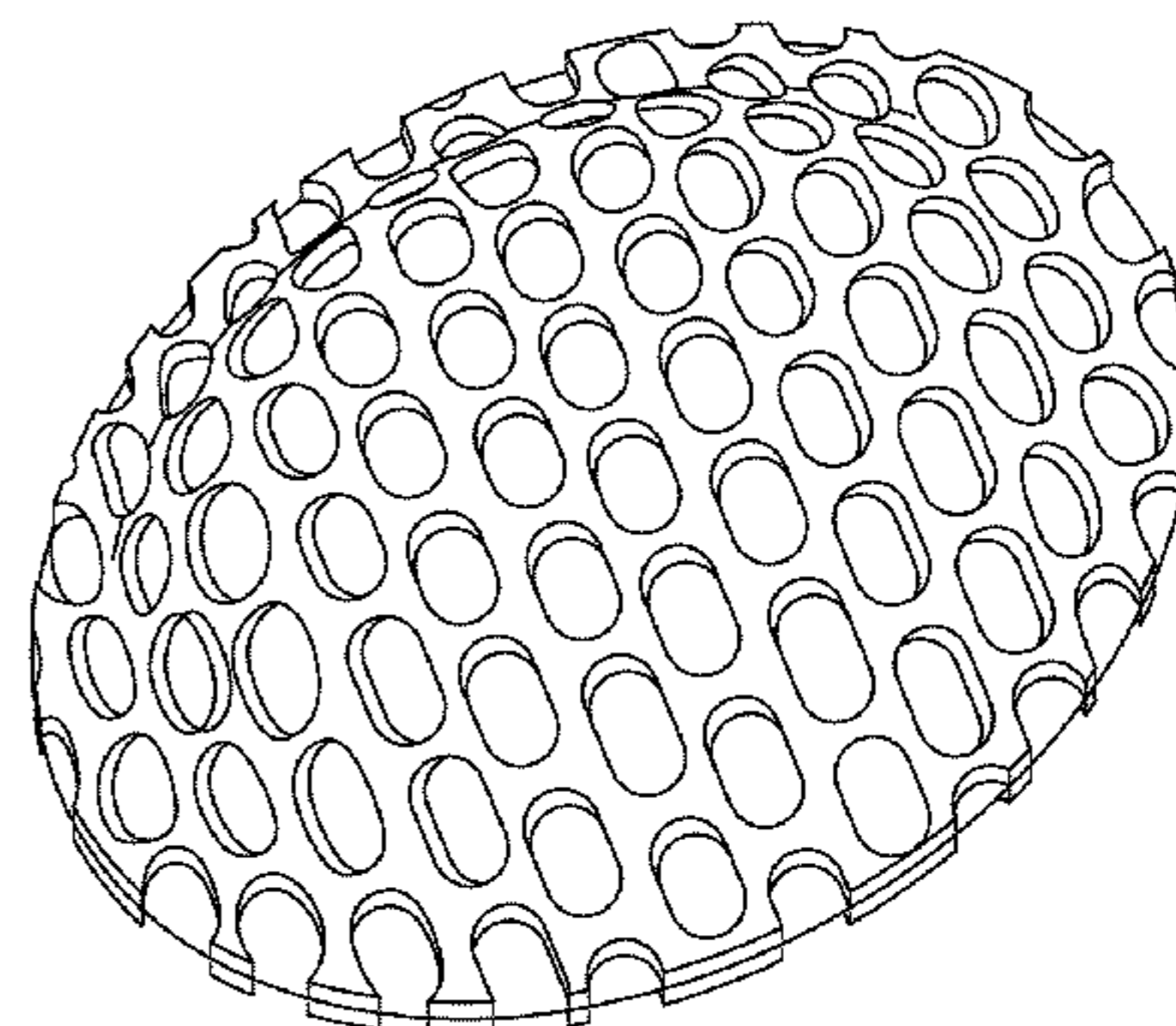
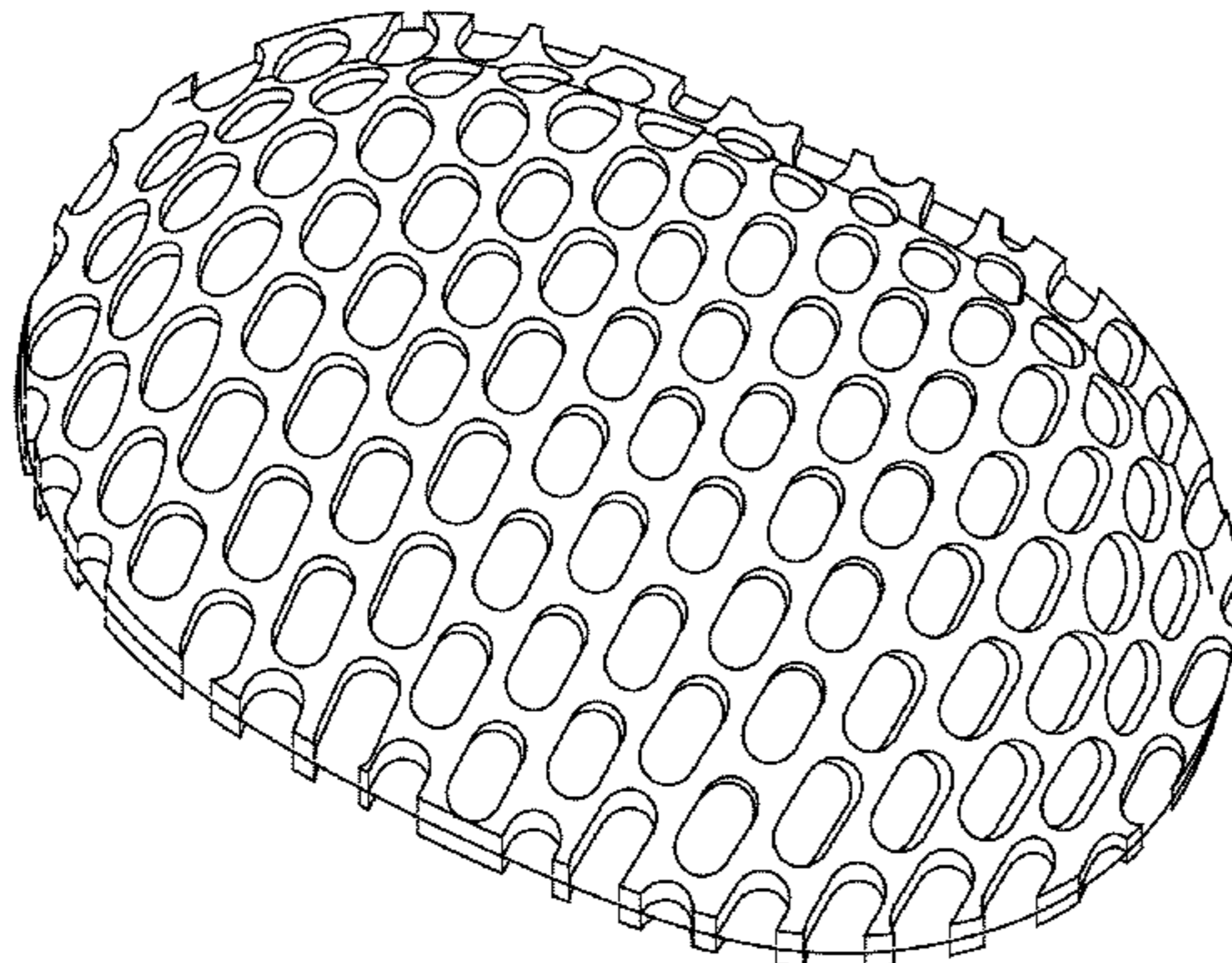

FIG. 3 is a left side elevation view of the deodorizer shown in FIG. 1.

FIG. 4 is a right side elevation view of the deodorizer shown in FIG. 1.

FIG. 5 is a top plan view of the deodorizer shown in FIG. 1.

FIG. 6 is a bottom plan view of the deodorizer shown in FIG. 1.

FIG. 7 is a front, right side perspective view of a second embodiment of a deodorizer according to the present design.

FIG. 8 is a front elevation view of the deodorizer shown in FIG. 7, the rear elevation view is identical to the front elevation view.

FIG. 9 is a left side elevation view of the deodorizer shown in FIG. 7.

FIG. 10 is a right side elevation view of the deodorizer shown in FIG. 7.

FIG. 11 is a top plan view of the deodorizer shown in FIG. 7.

FIG. 12 is a bottom plan view of the deodorizer shown in FIG. 7.

FIG. 13 is a front, left side perspective view of a third embodiment of a deodorizer according to the present design.

FIG. 14 is a front elevation view of the deodorizer shown in FIG. 13, the rear elevation view is identical to the front elevation view.

FIG. 15 is a left side elevation view of the deodorizer shown in FIG. 13.

FIG. 16 is a right side elevation view of the deodorizer shown in FIG. 13.

FIG. 17 is a top plan view of the deodorizer shown in FIG. 13.

FIG. 18 is a bottom plan view of the deodorizer shown in FIG. 13.

FIG. 19 is a front, right side perspective view of a fourth embodiment of a deodorizer according to the present design.

FIG. 20 is a front elevation view of the deodorizer shown in FIG. 19, the rear elevation view is identical to the front elevation view.

FIG. 21 is a left side elevation view of the deodorizer shown in FIG. 19.

FIG. 22 is a right side elevation view of the deodorizer shown in FIG. 19.

FIG. 23 is a top plan view of the deodorizer shown in FIG. 19.

FIG. 24 is a bottom plan view of the deodorizer shown in FIG. 19.

FIG. 25 is a front, left side perspective view of a fifth embodiment of a deodorizer according to the present design.

FIG. 26 is a front elevation view of the deodorizer shown in FIG. 25, the rear elevation view is identical to the front elevation view.

FIG. 27 is a left side elevation view of the deodorizer shown in FIG. 25.

FIG. 28 is a right side elevation view of the deodorizer shown in FIG. 25.

FIG. 29 is a top plan view of the deodorizer shown in FIG. 25.

FIG. 30 is a bottom plan view of the deodorizer shown in FIG. 25.

FIG. 31 is a front, right side perspective view of a sixth embodiment of a deodorizer according to the present design.

FIG. 32 is a front elevation view of the deodorizer shown in FIG. 31, the rear elevation view is identical to the front elevation view.

FIG. 33 is a left side elevation view of the deodorizer shown in FIG. 31.

FIG. 34 is a right side elevation view of the deodorizer shown in FIG. 31.

FIG. 35 is a top plan view of the deodorizer shown in FIG. 31; and,

FIG. 36 is a bottom plan view of the deodorizer shown in FIG. 31.

The broken lines illustrate portions of the embodiment of the deodorizer and form no part of the claimed design.

**1 Claim, 12 Drawing Sheets**

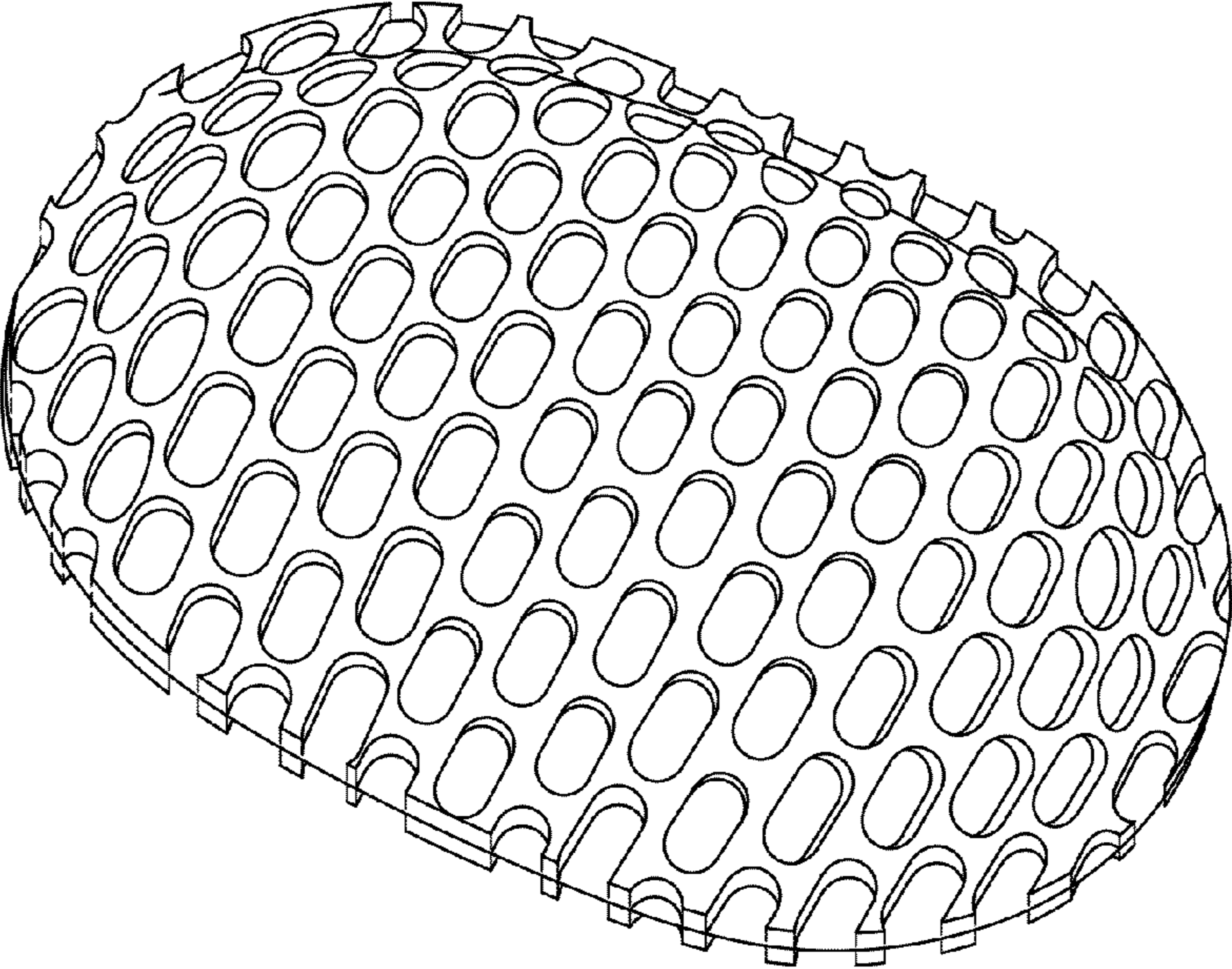

FIG. 1

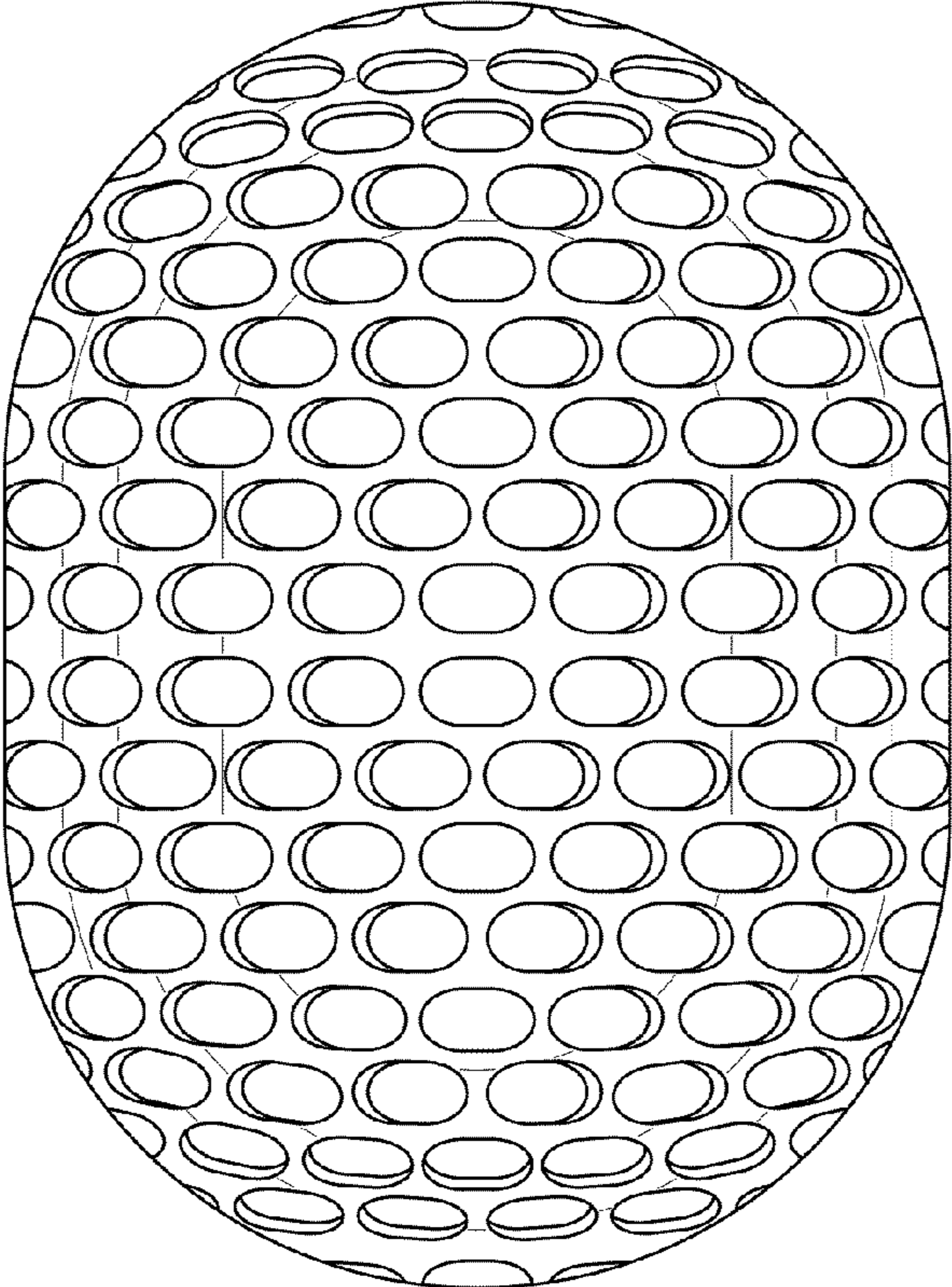

FIG. 2

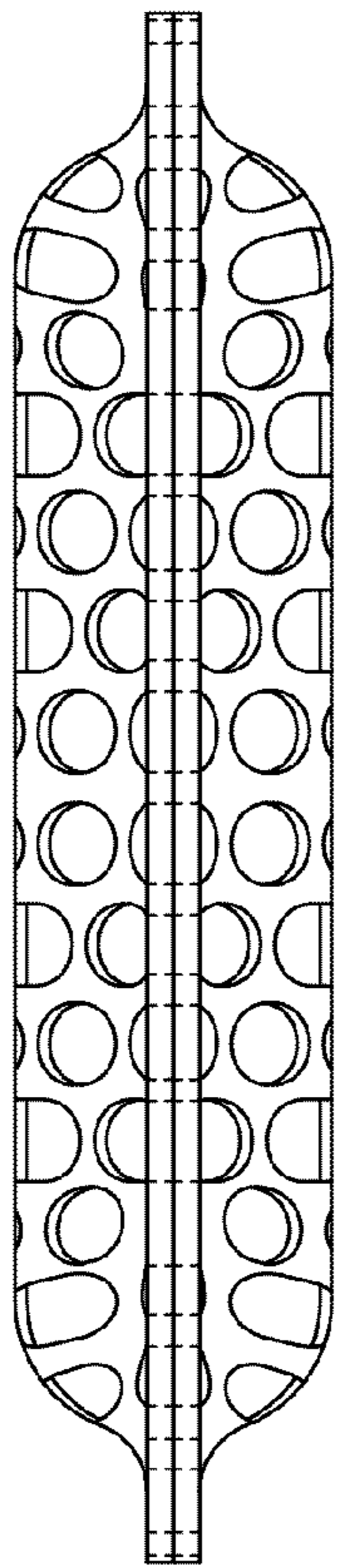

FIG. 3

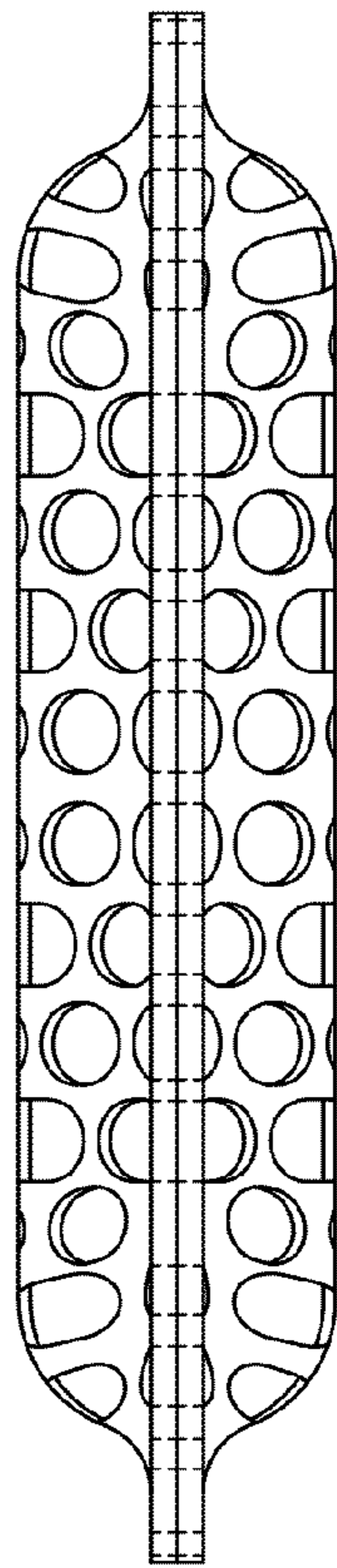

FIG. 4

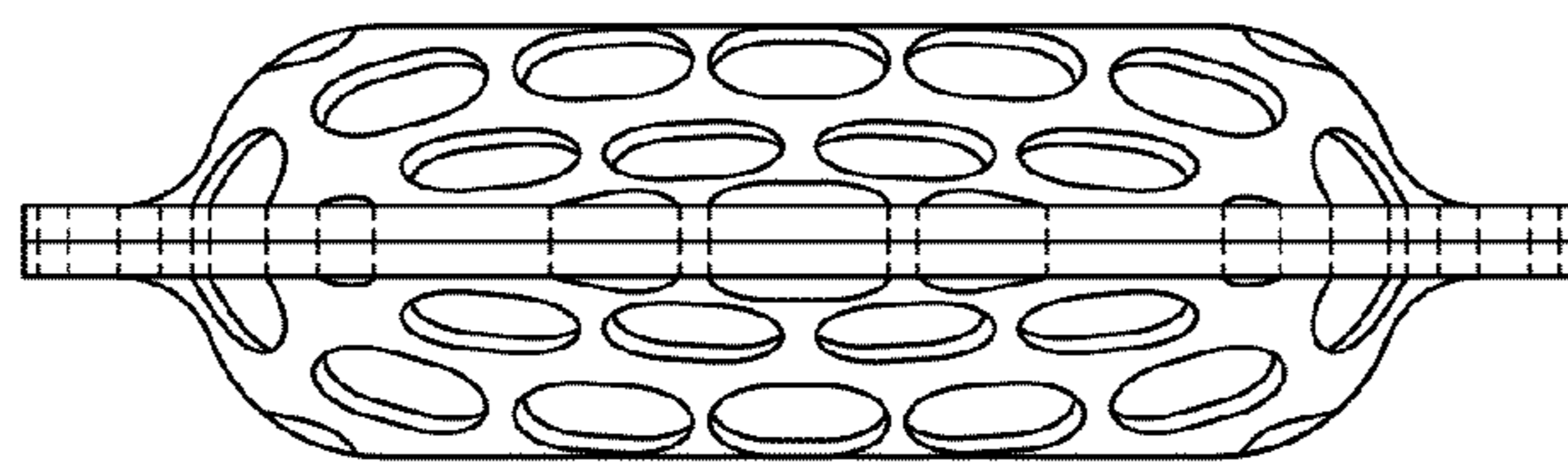

FIG. 5

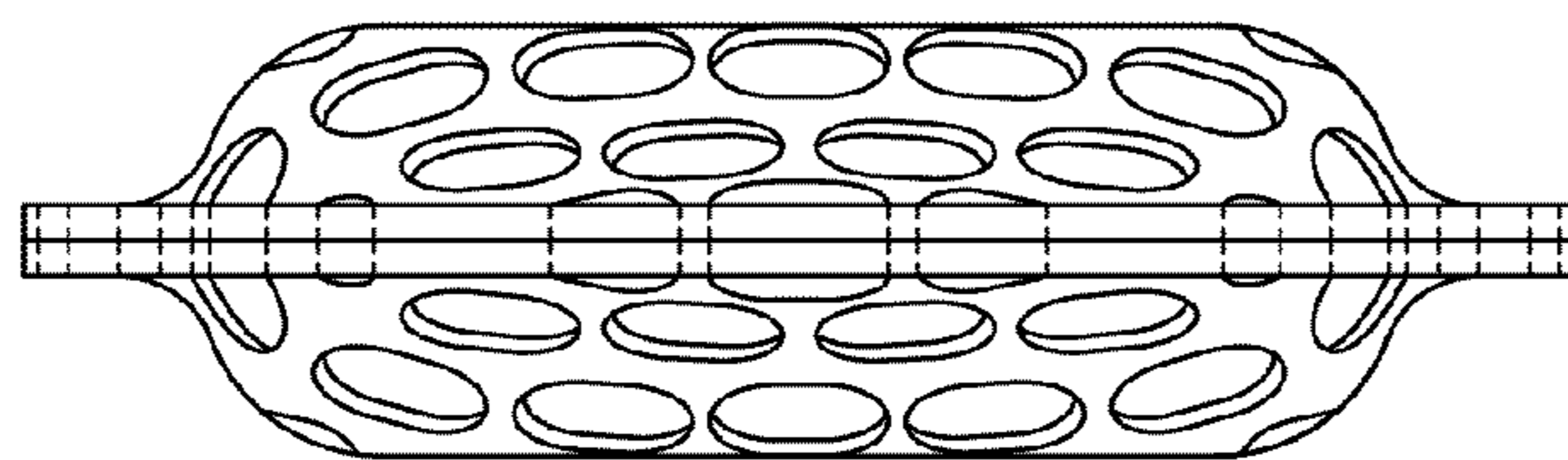

FIG. 6

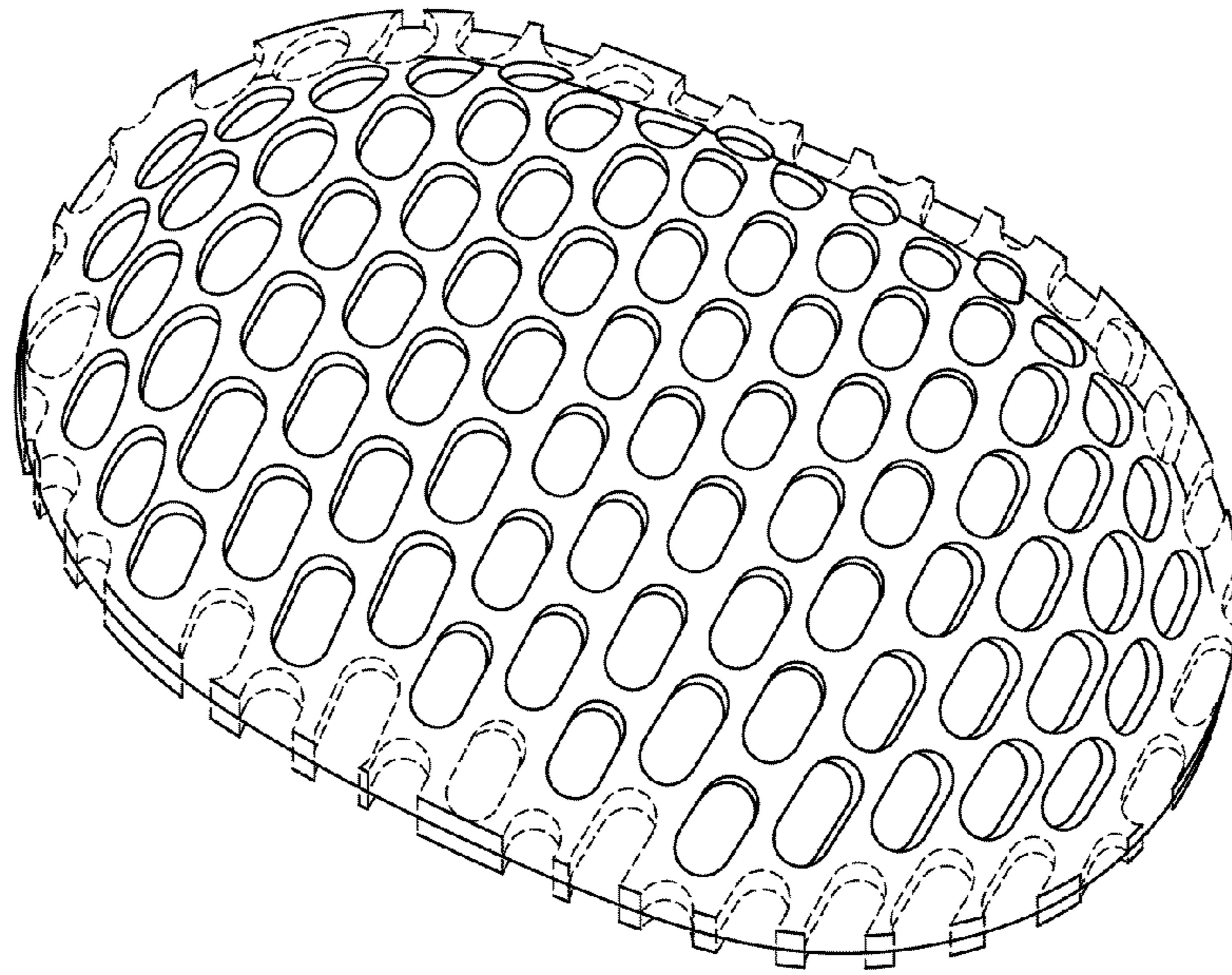

FIG. 7

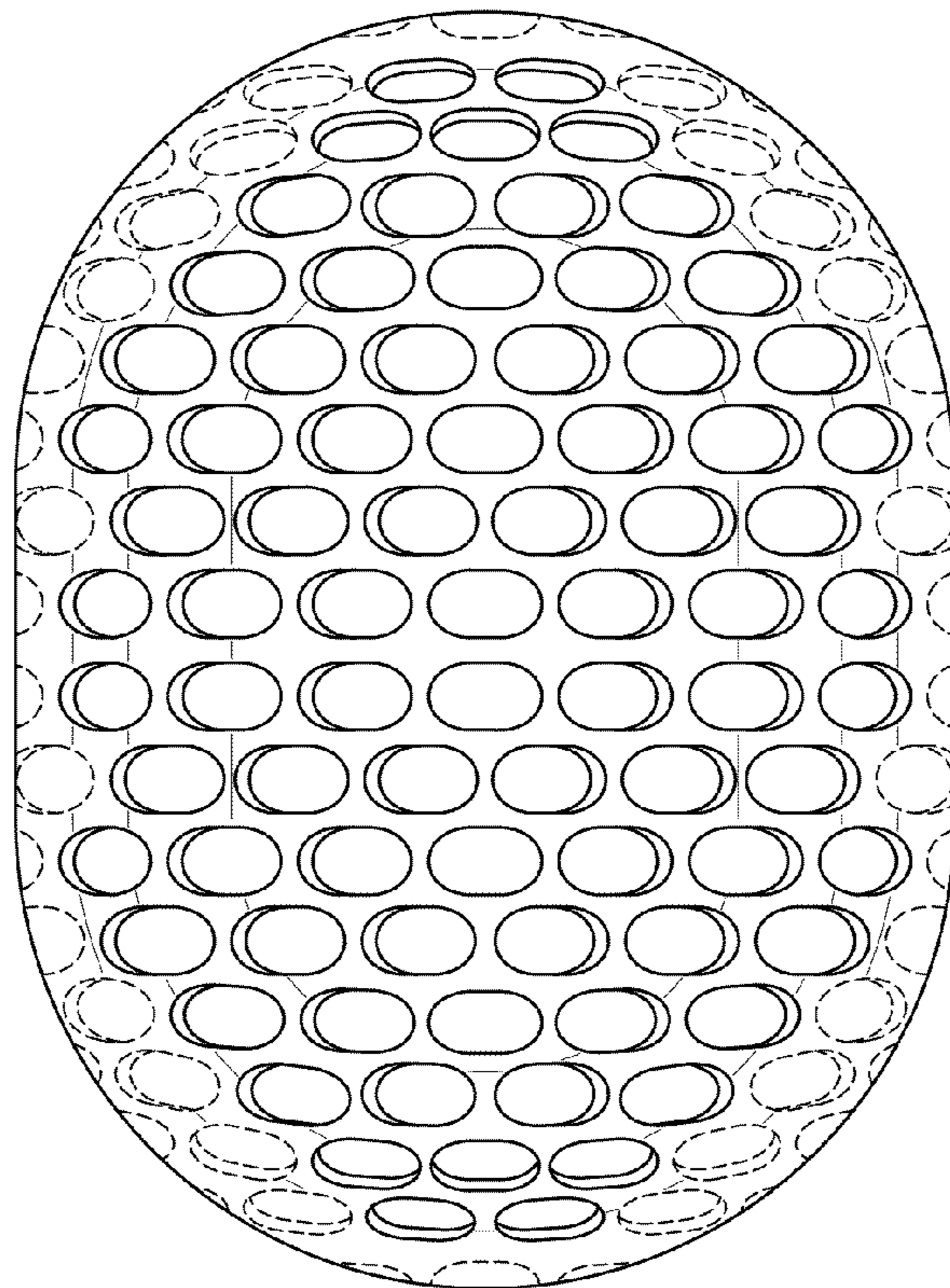

FIG. 8

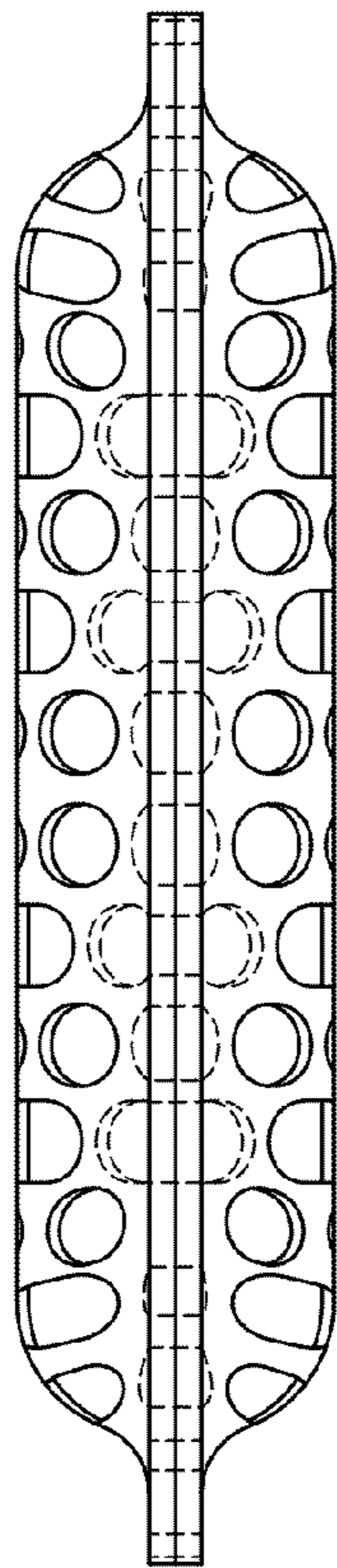

FIG. 9

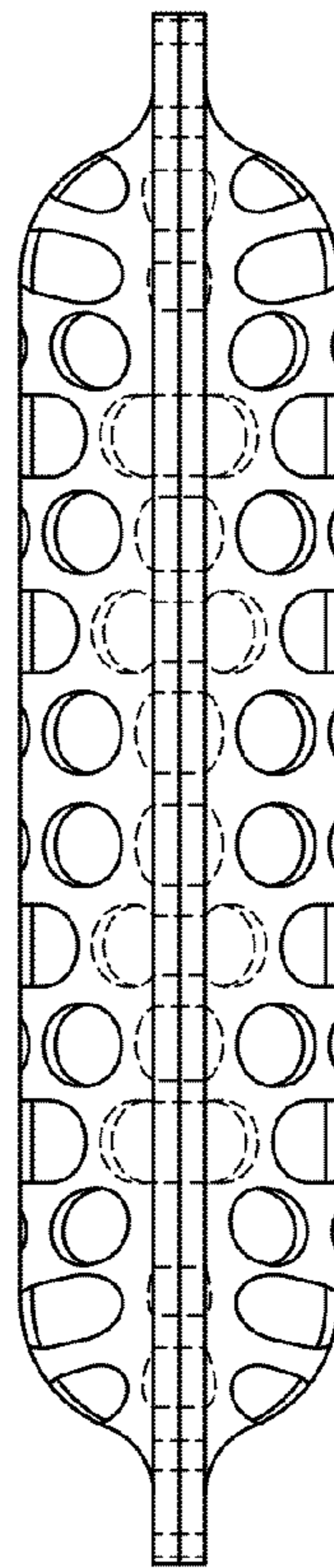

FIG. 10

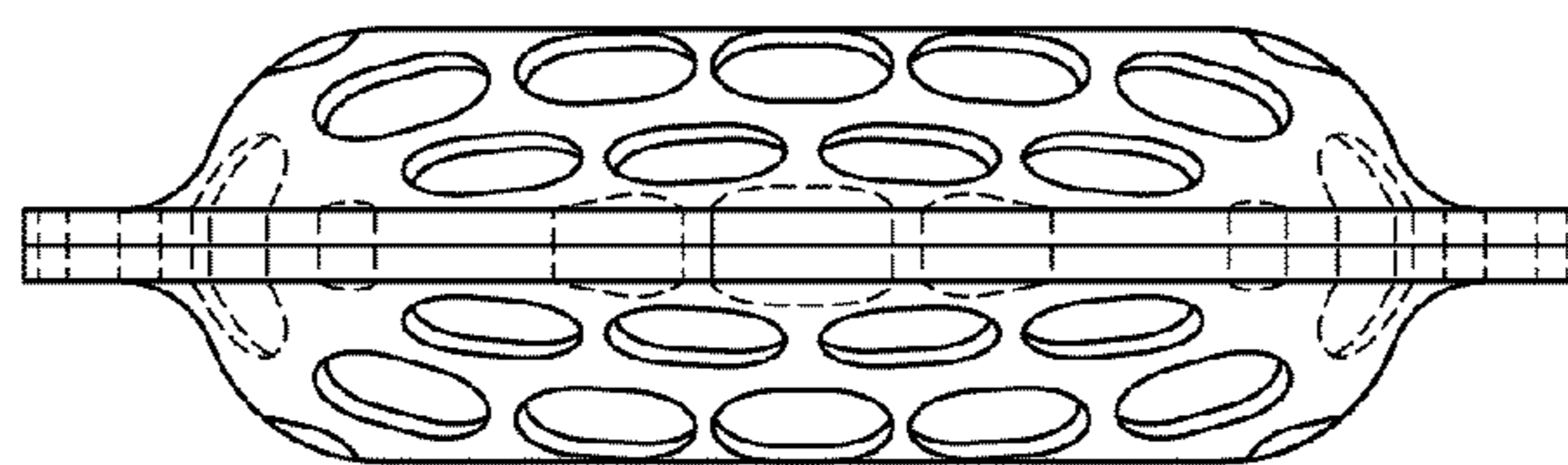

FIG. 11

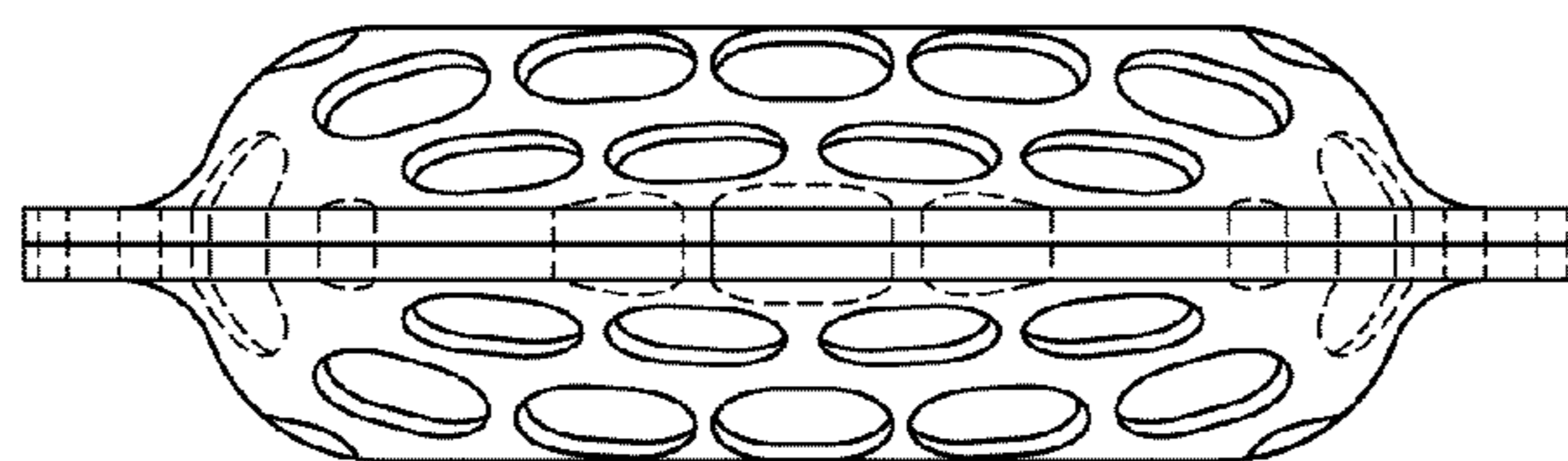

FIG. 12

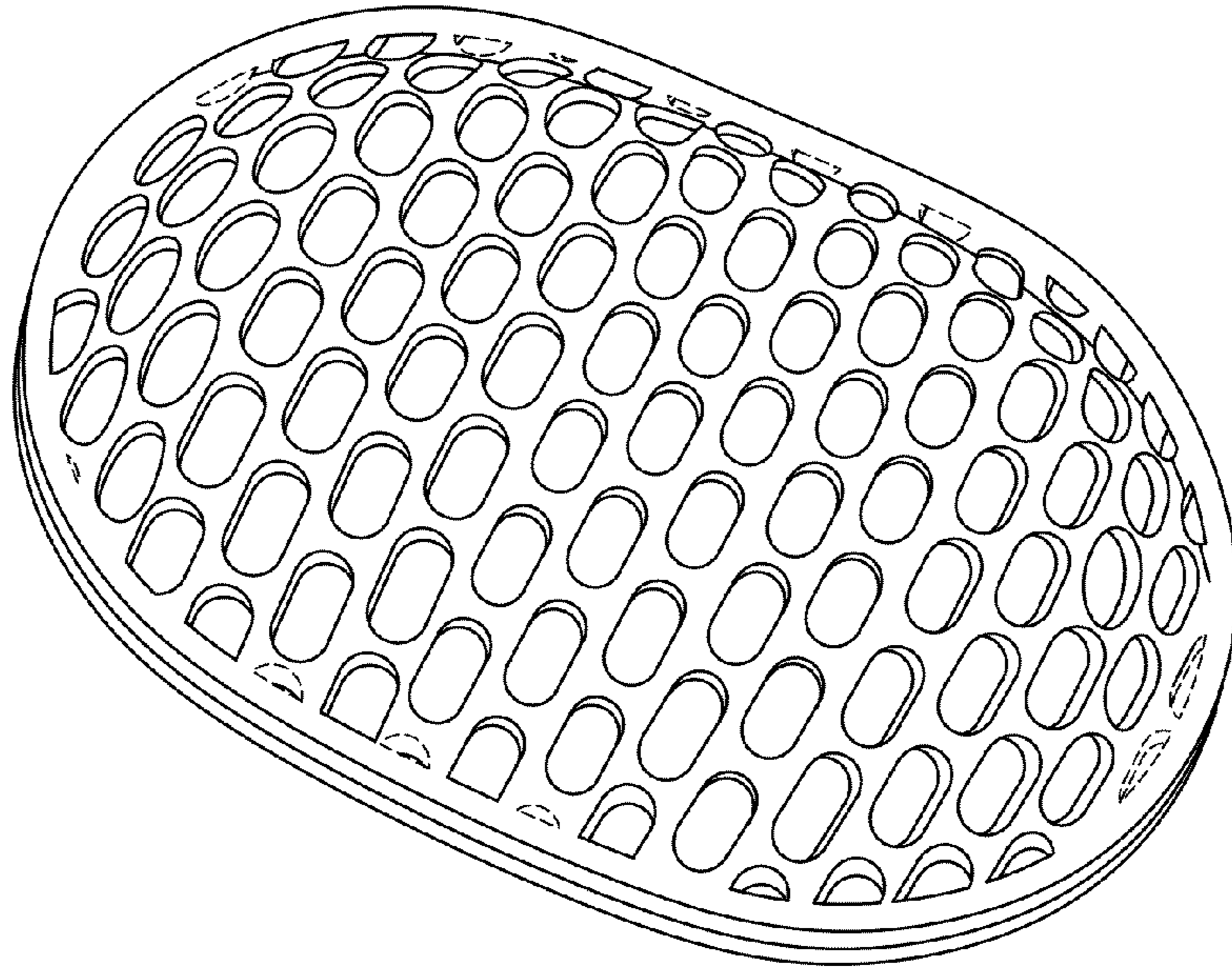

FIG. 13

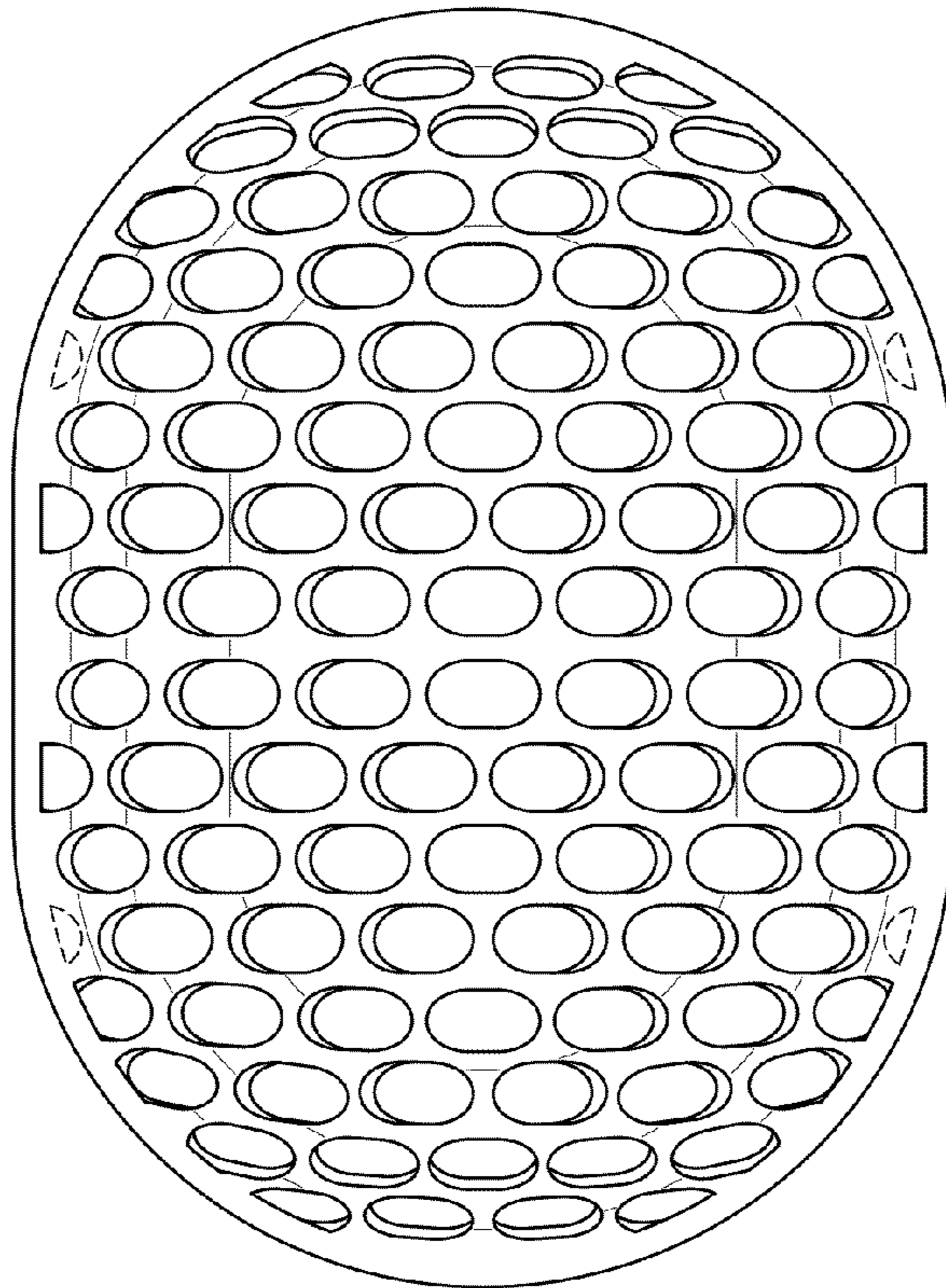

FIG. 14

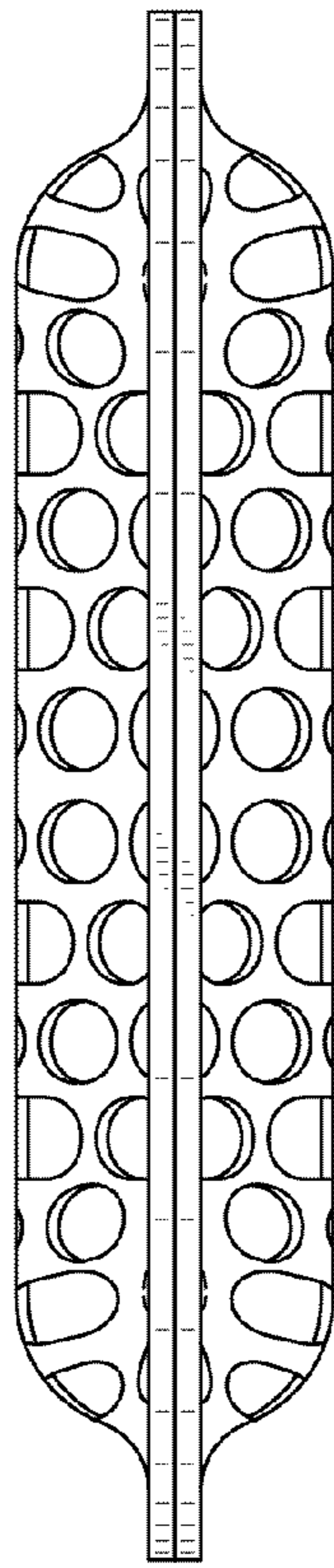

FIG. 15

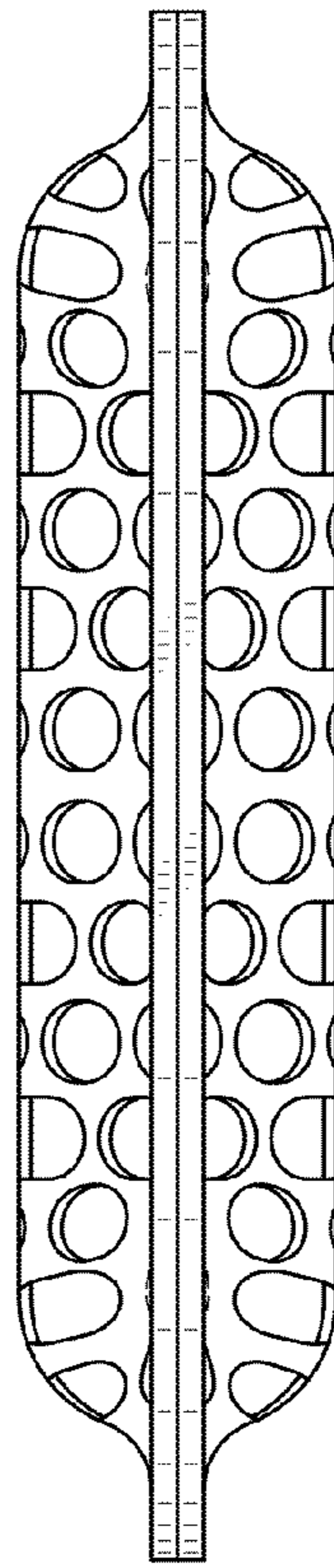

FIG. 16

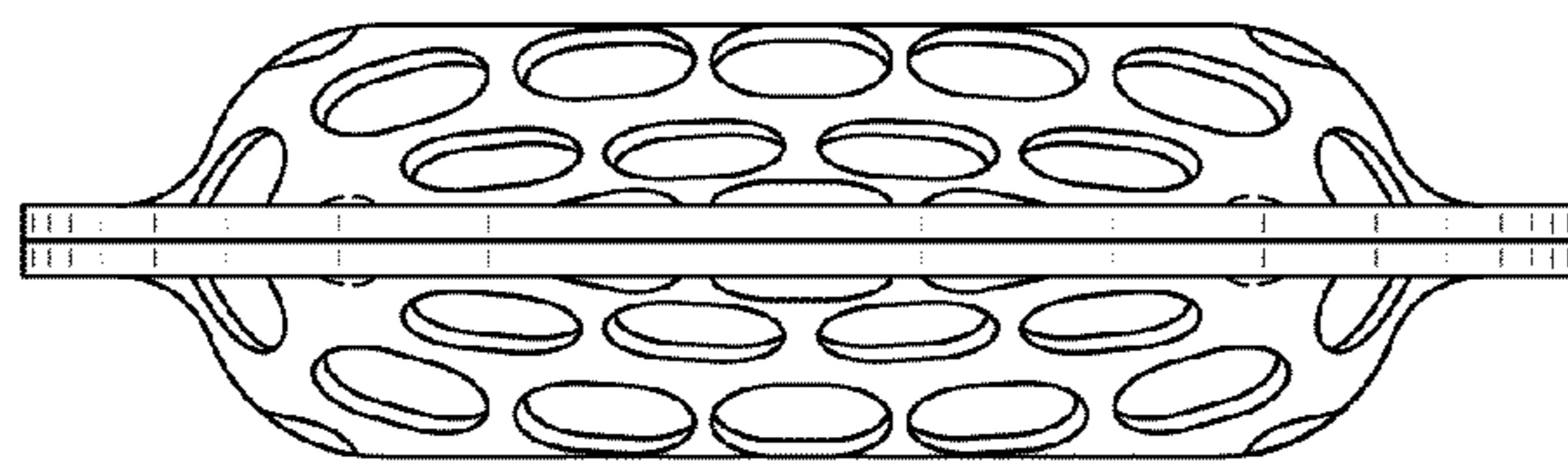

FIG. 17

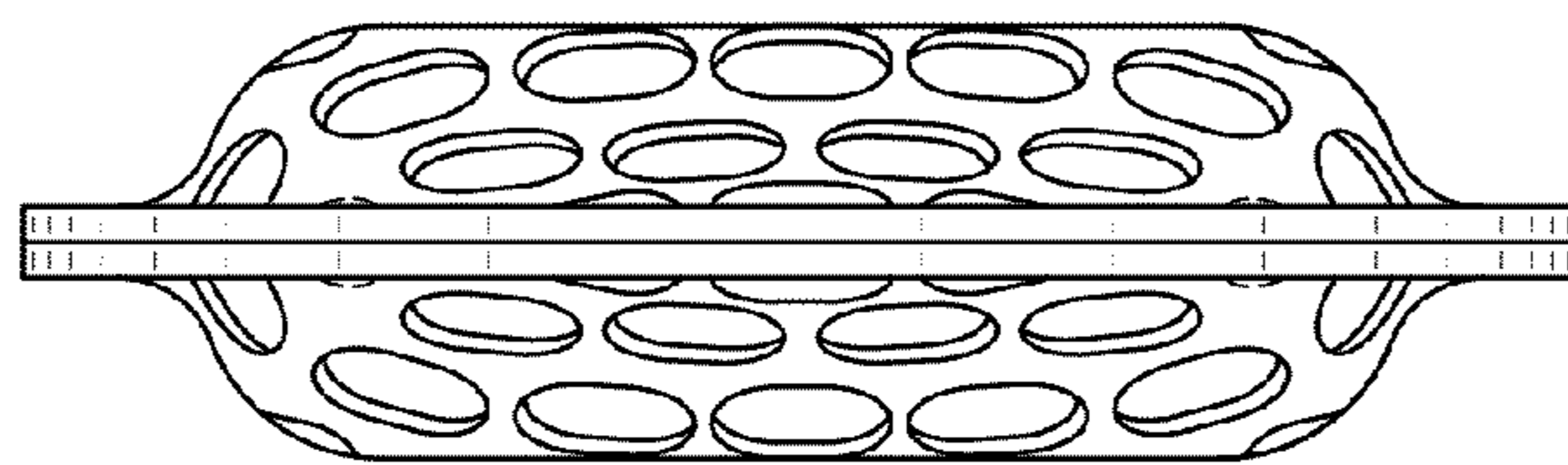

FIG. 18



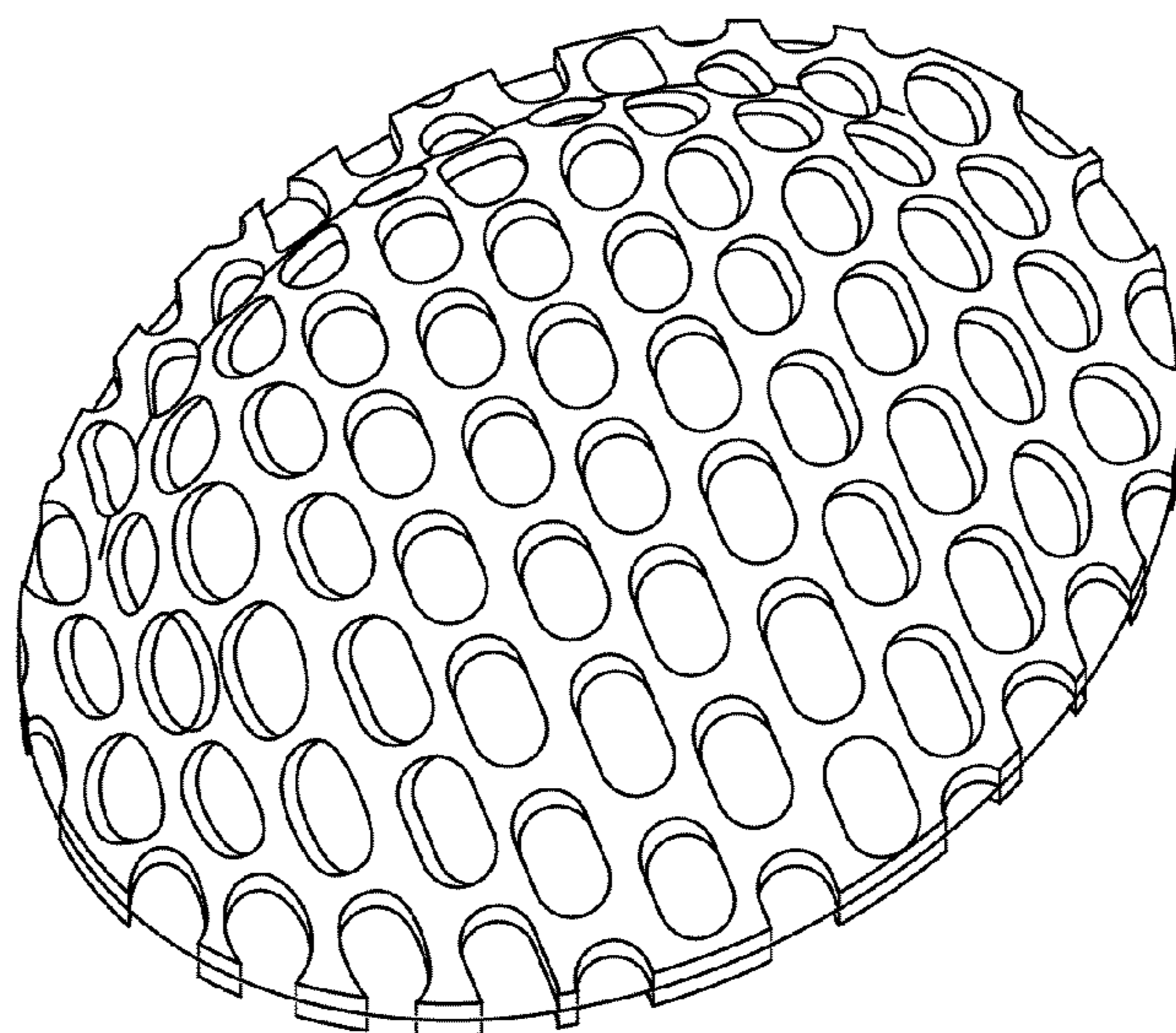

FIG. 19

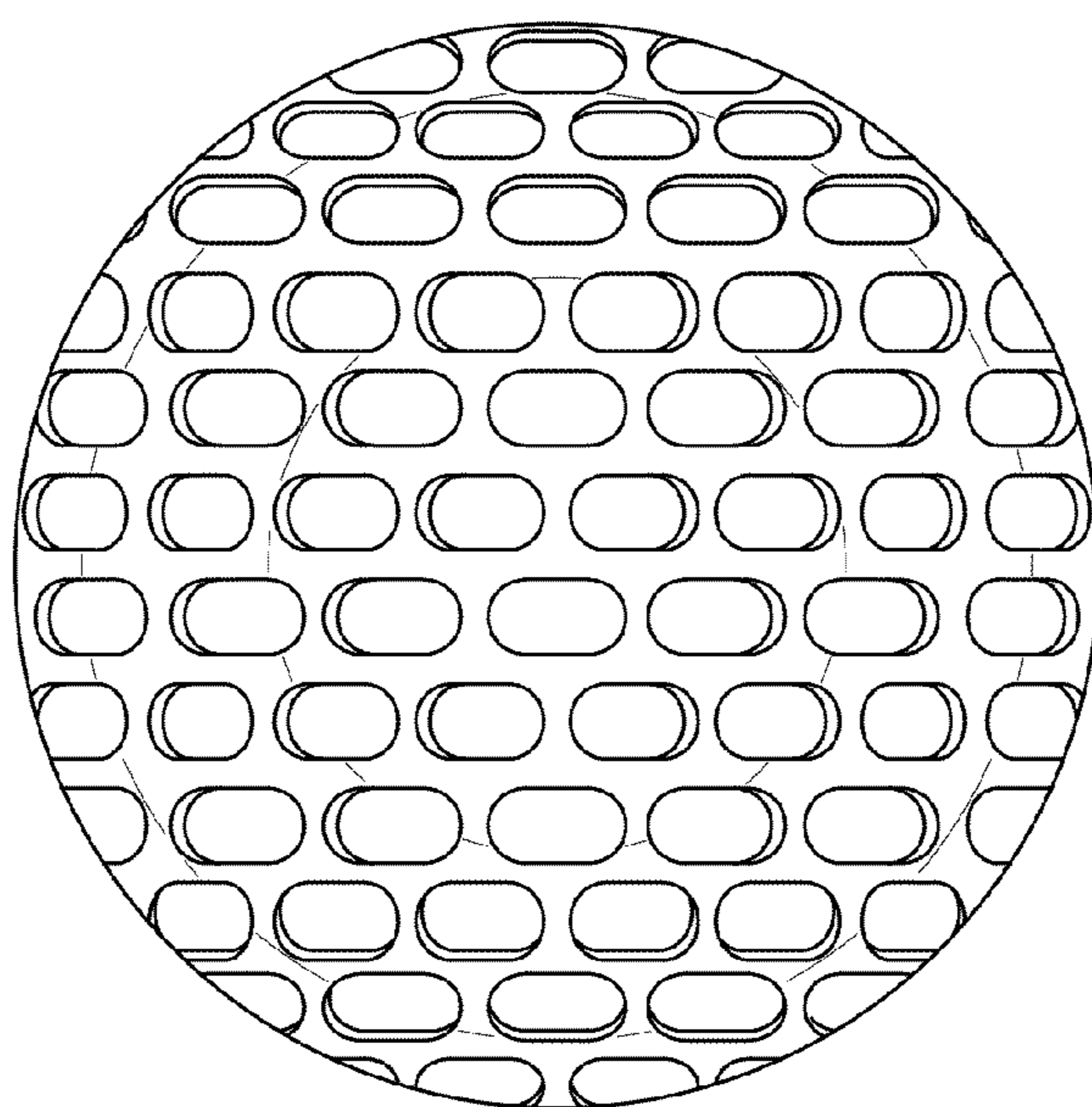

FIG. 20

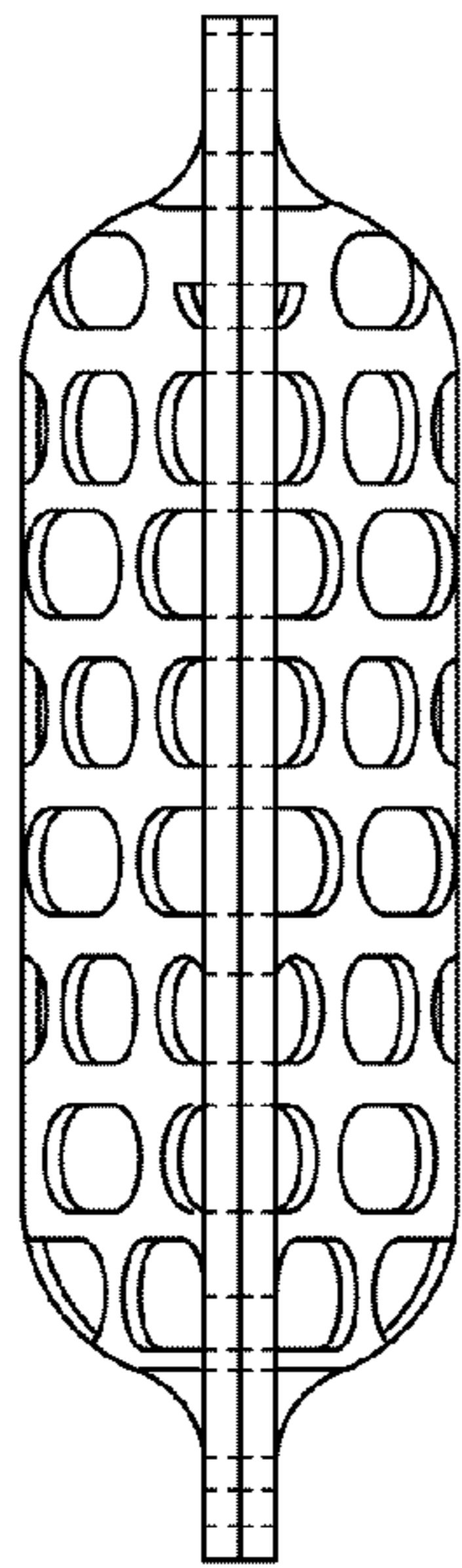

FIG. 21

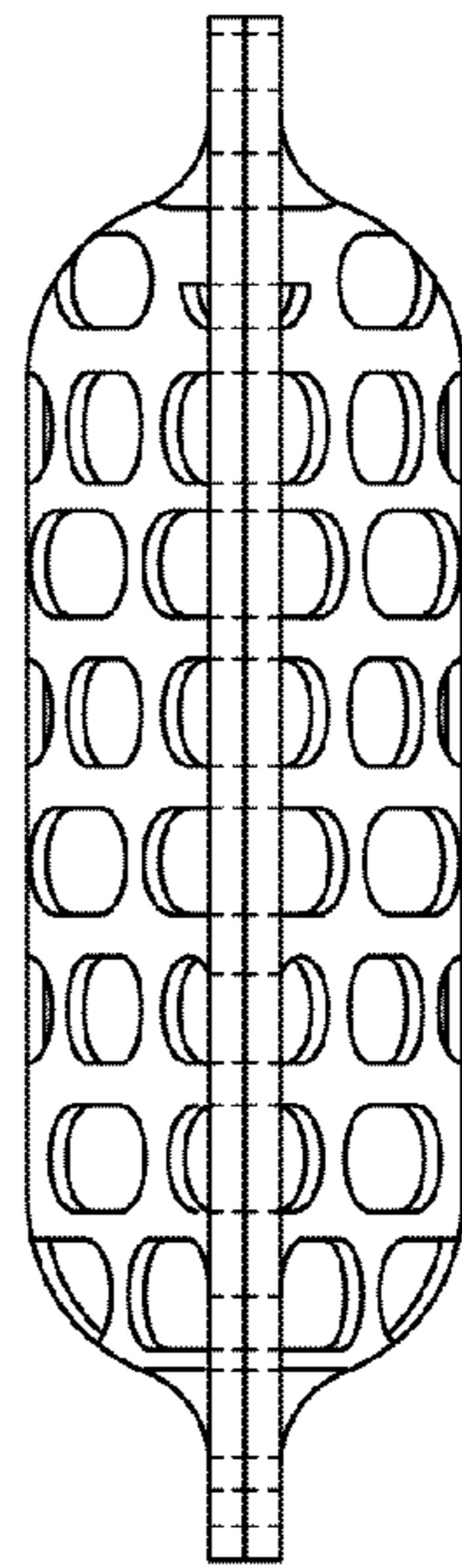

FIG. 22

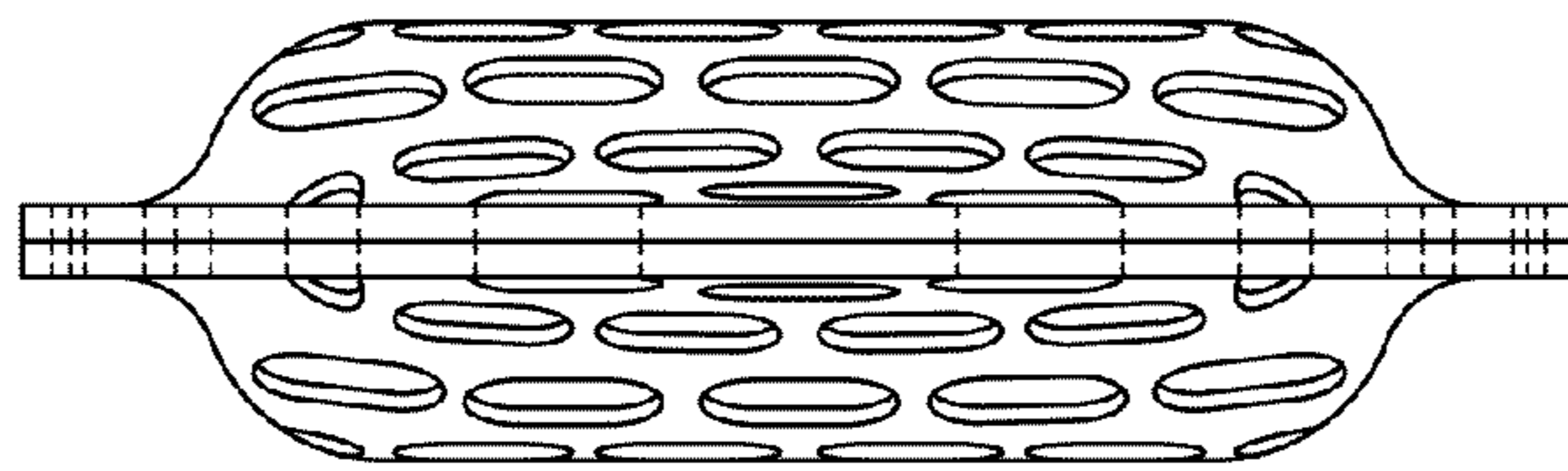

FIG. 23

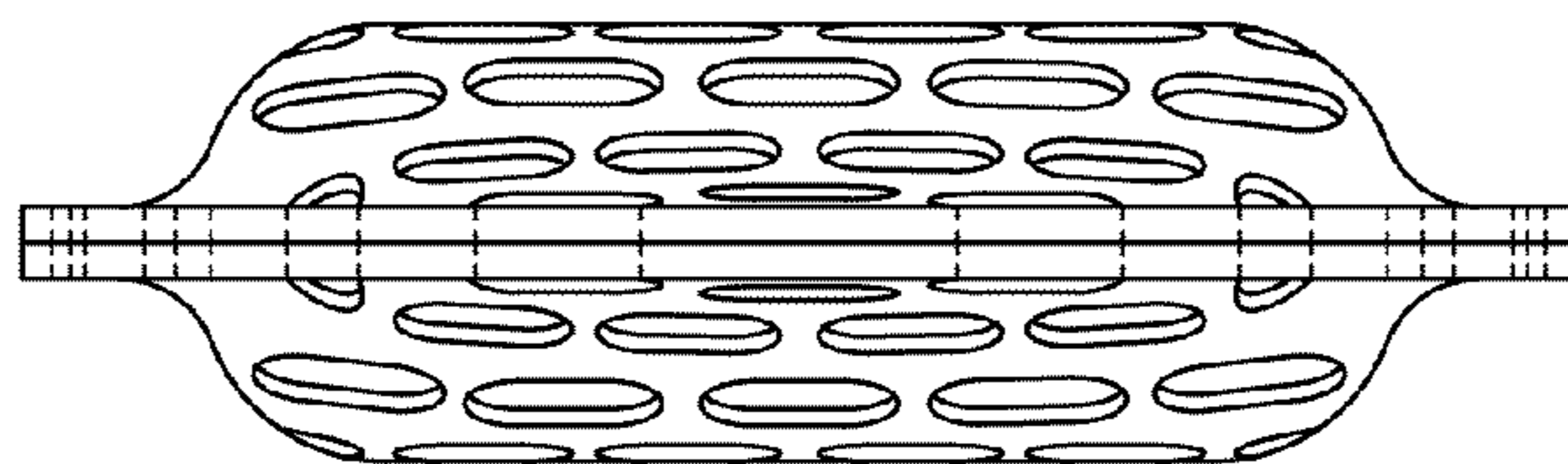

FIG. 24

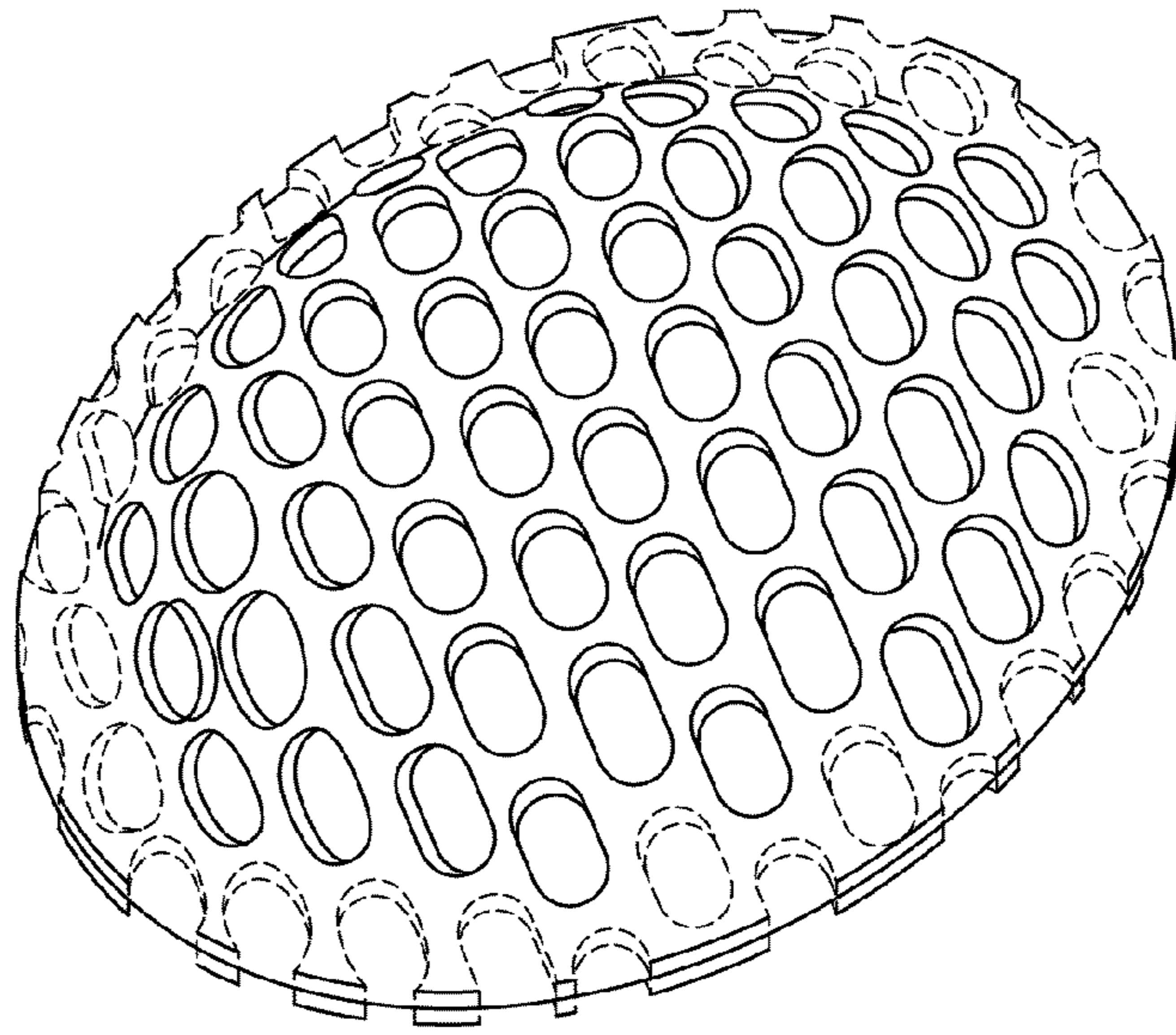

FIG. 25

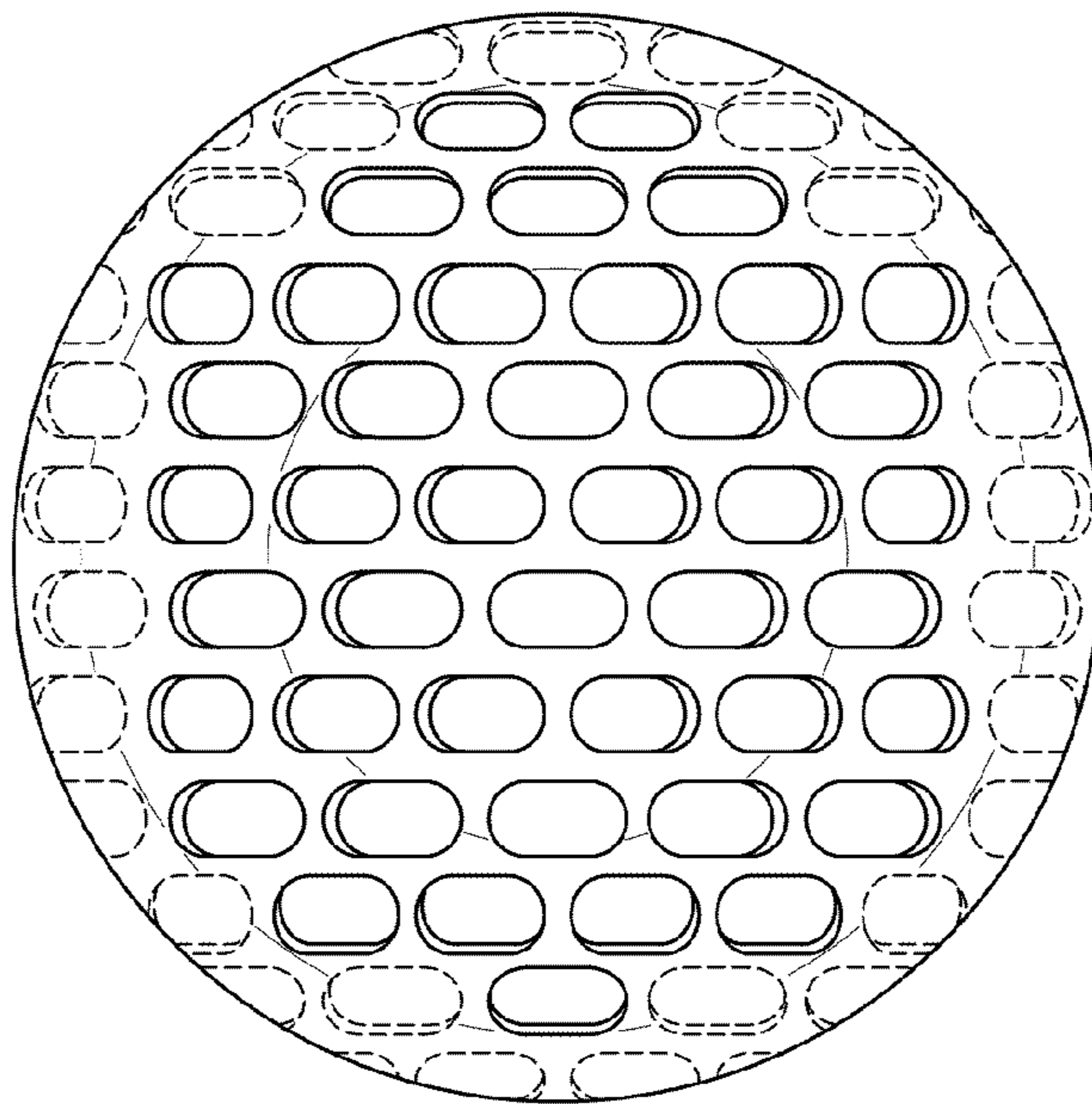

FIG. 26

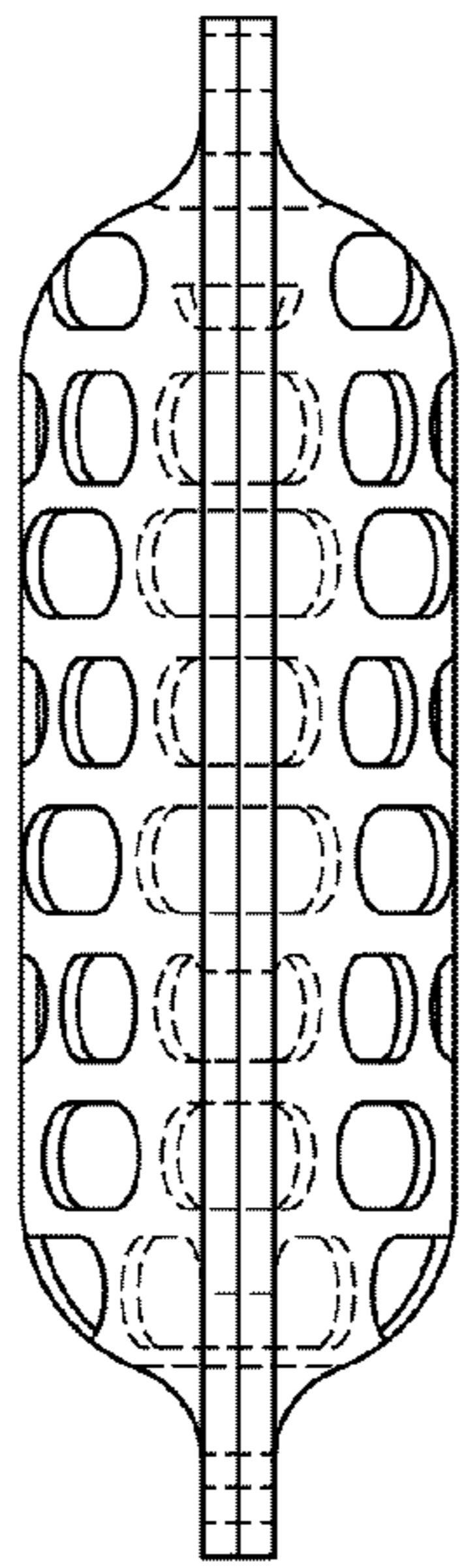

FIG. 27

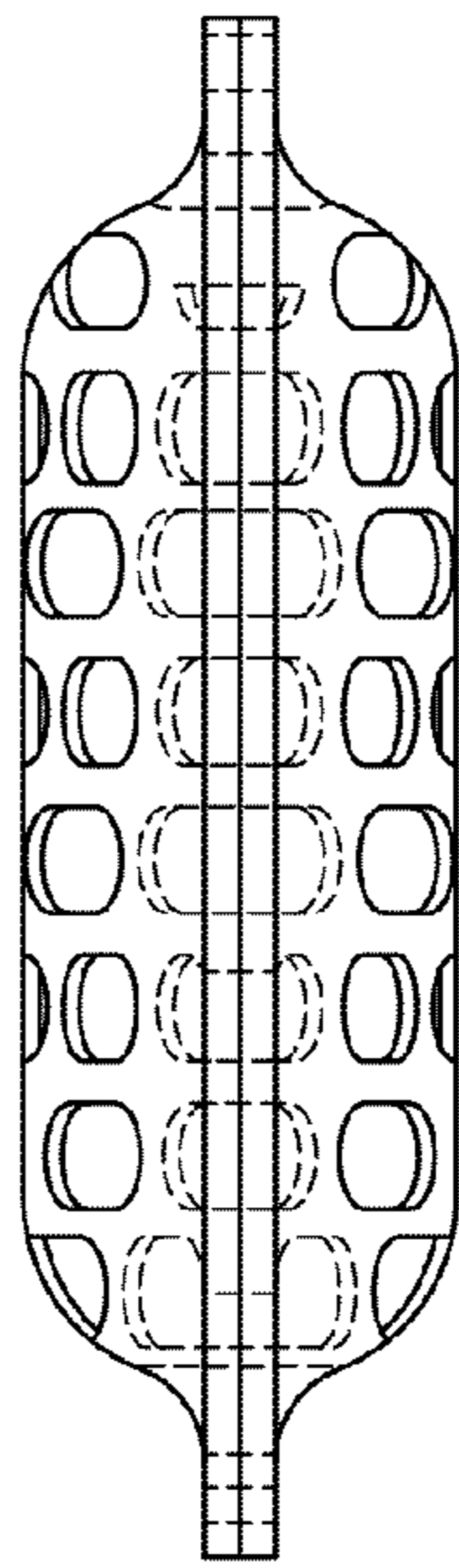

FIG. 28

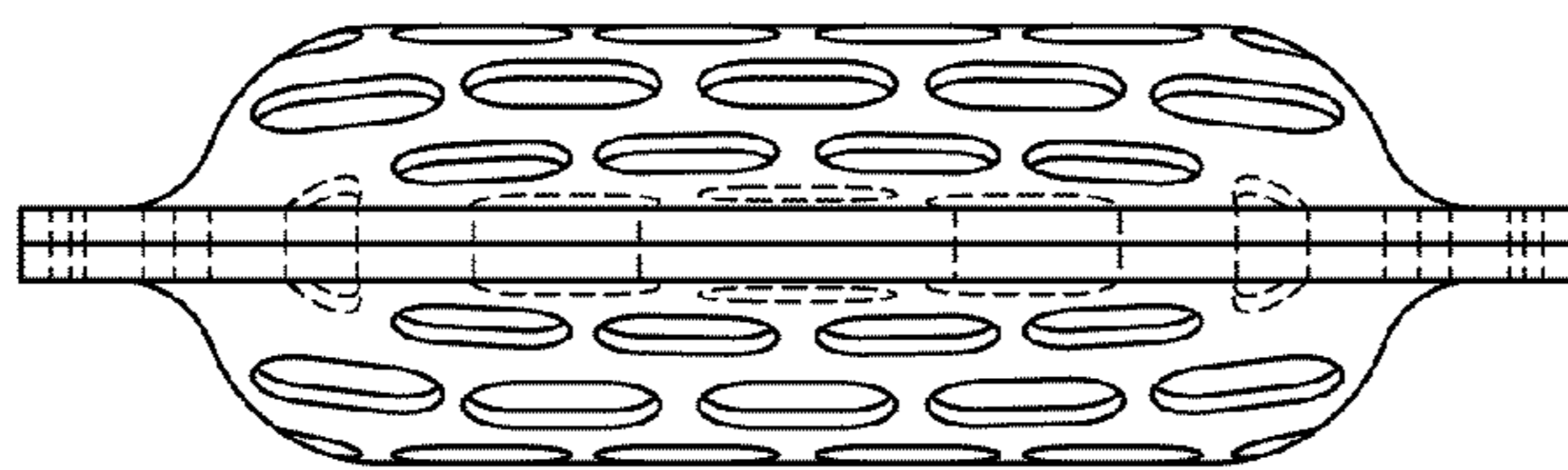

FIG. 29

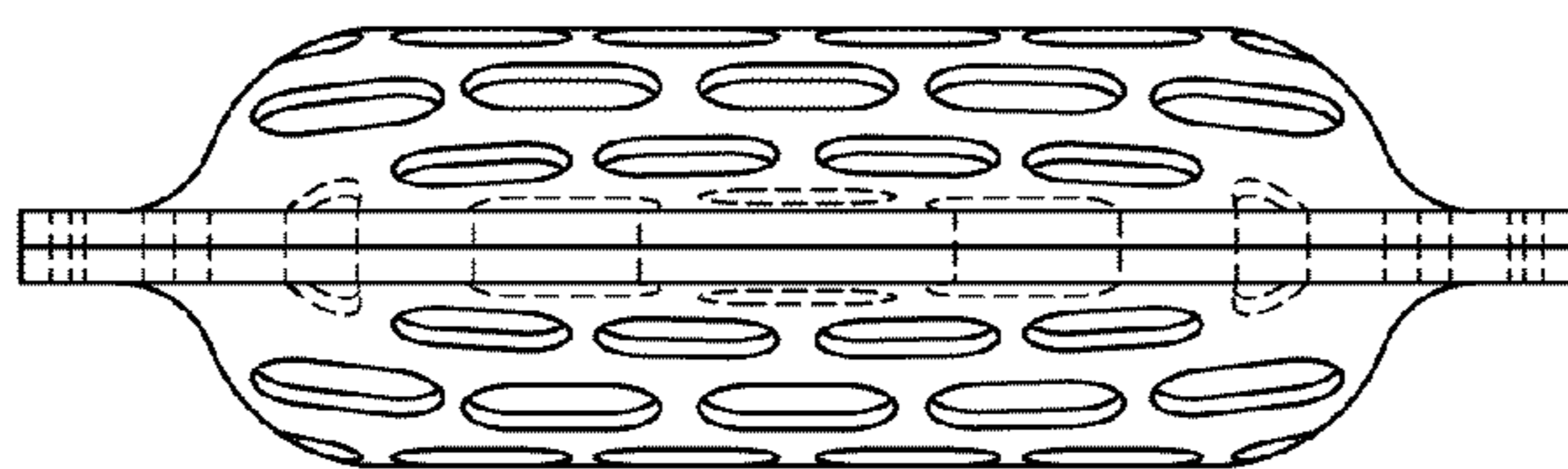

FIG. 30

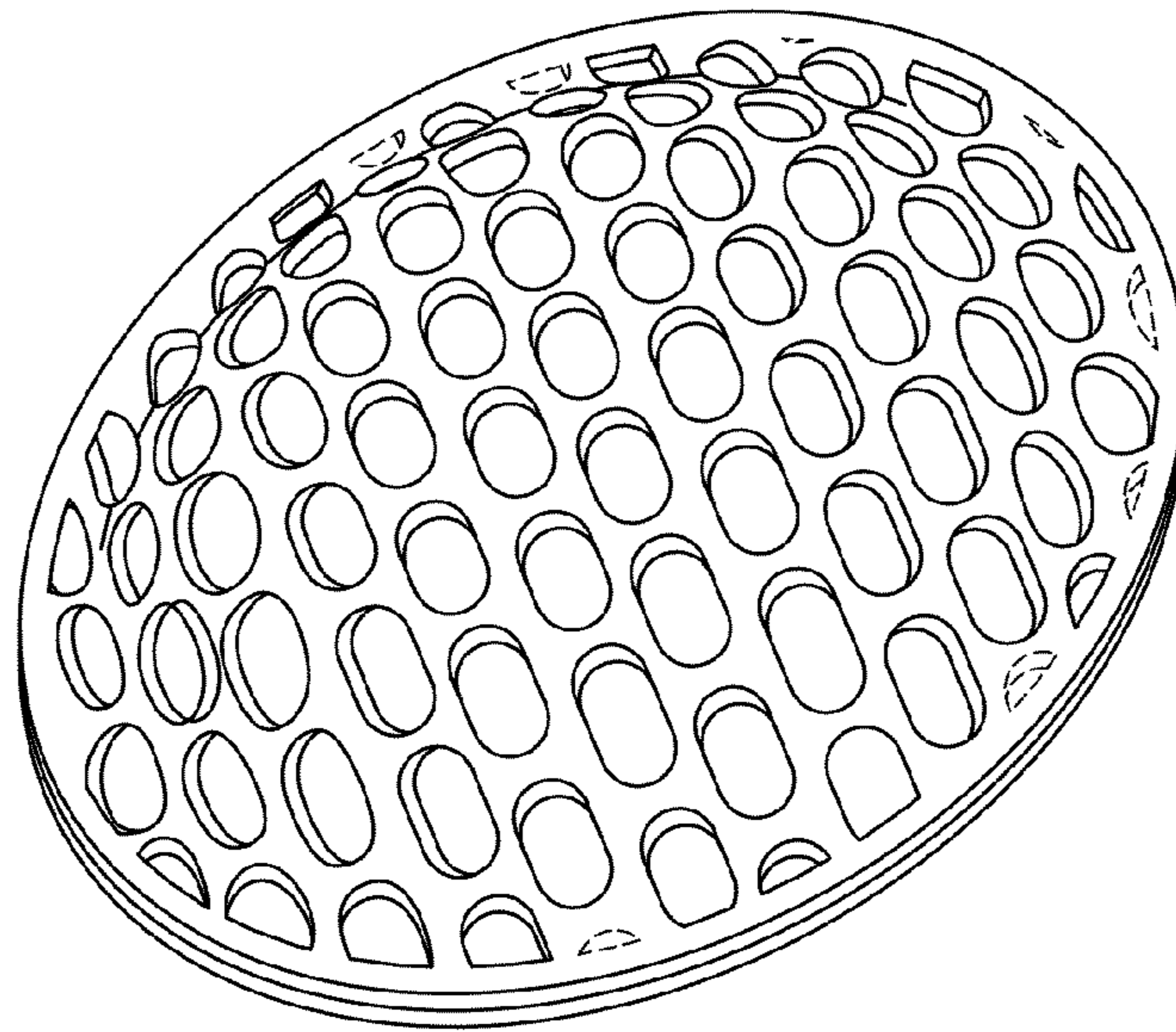

FIG. 31

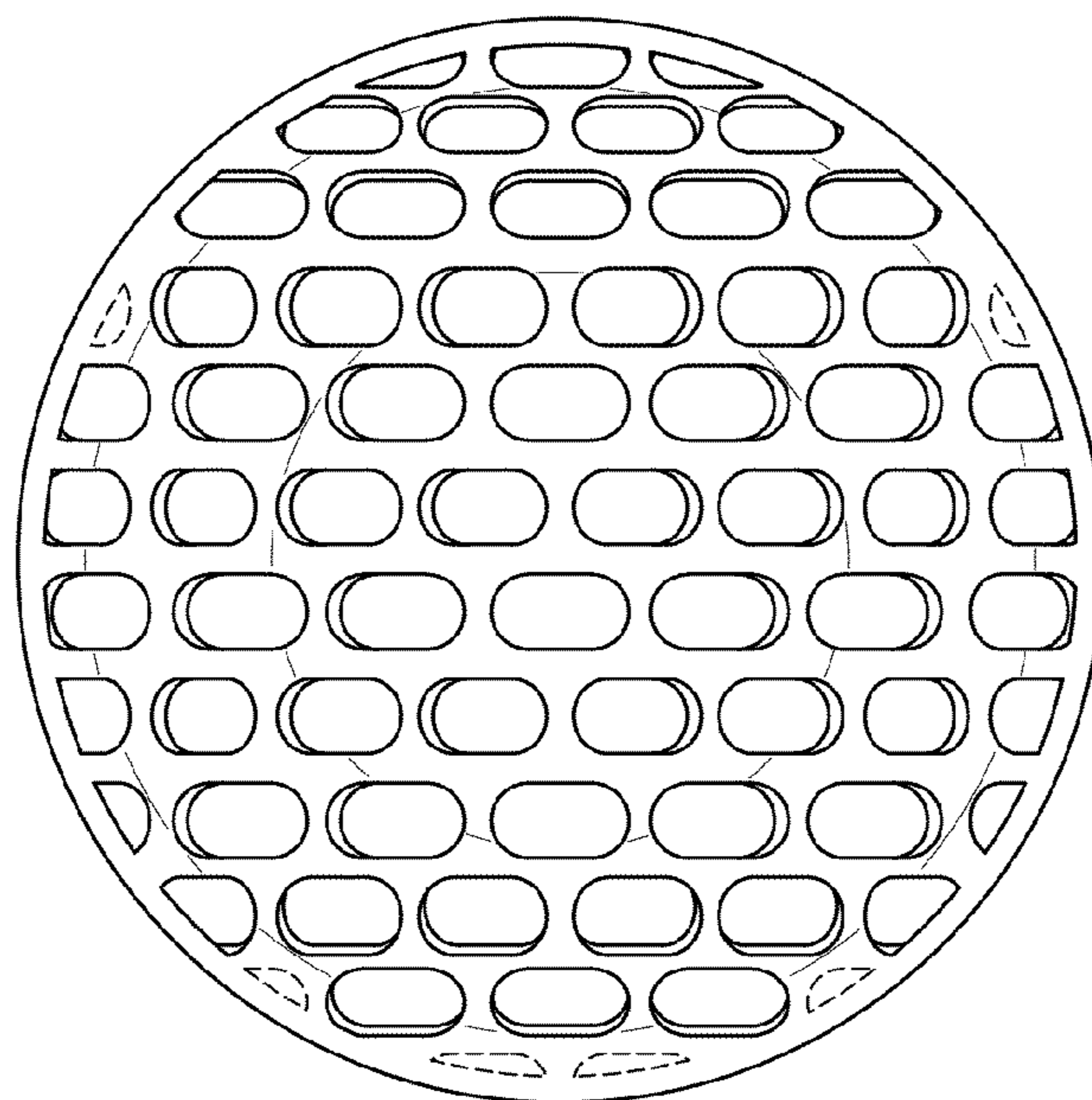

FIG. 32

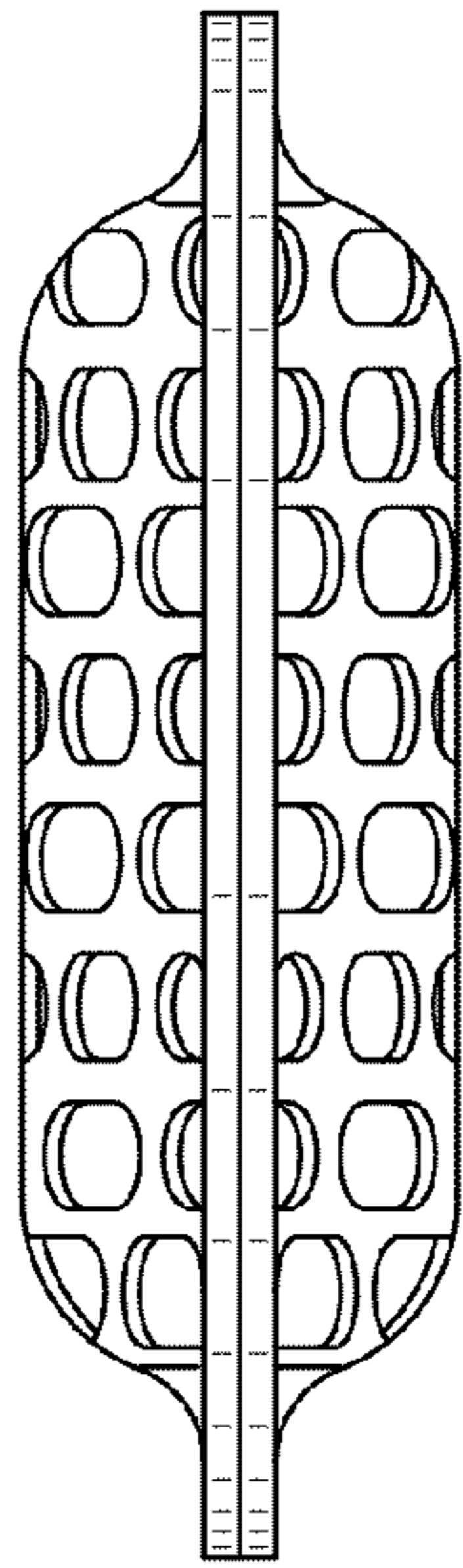

FIG. 33

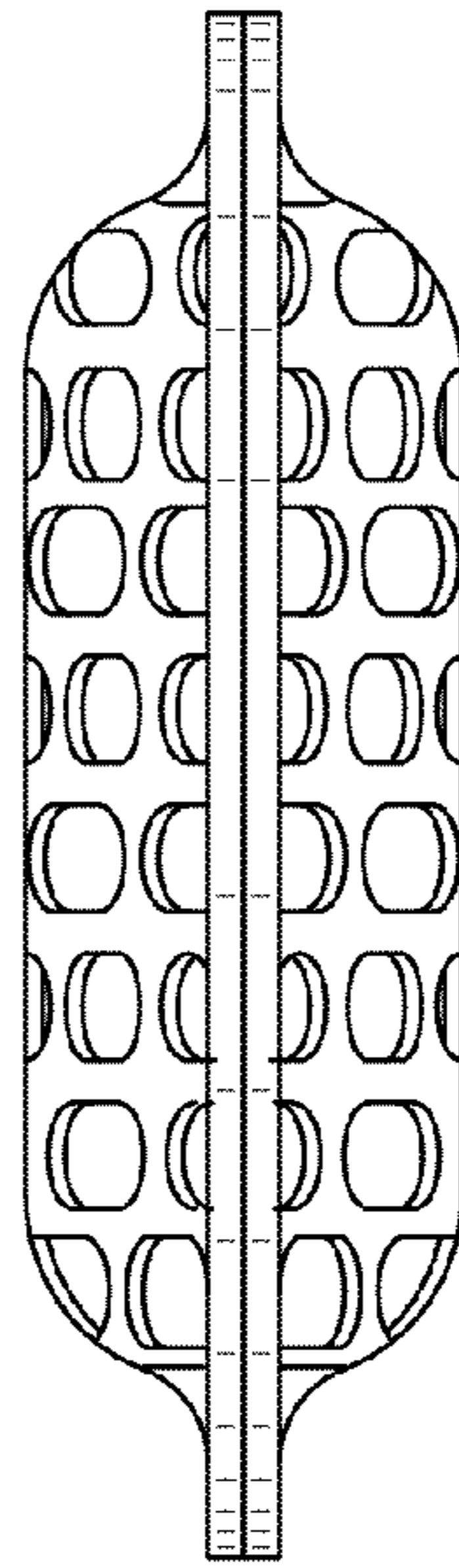

FIG. 34

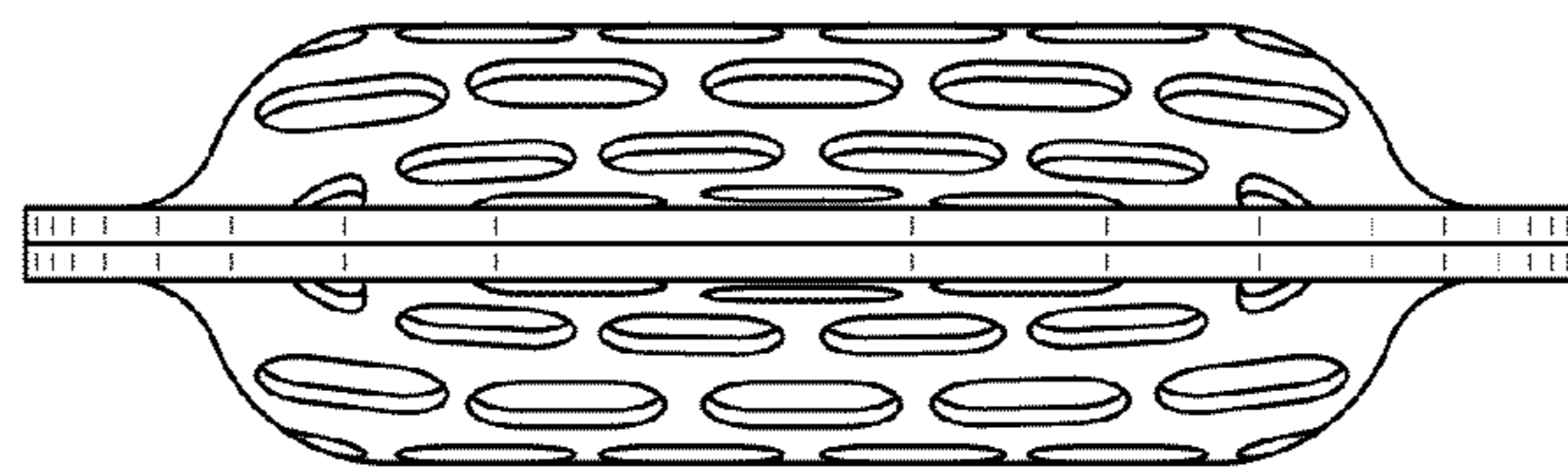

FIG. 35

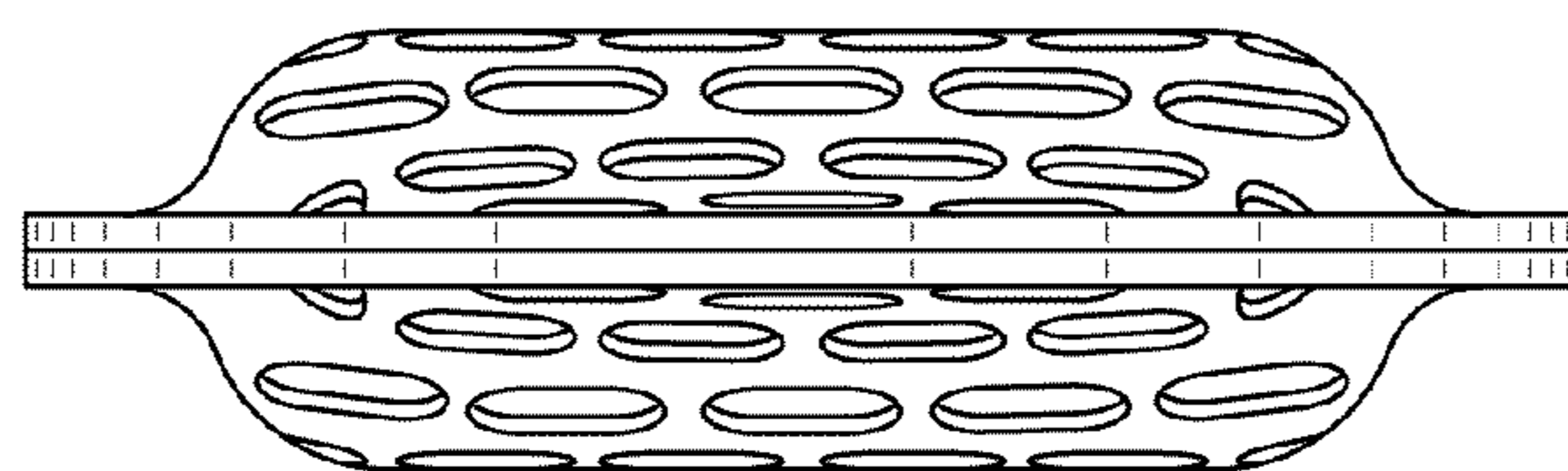

FIG. 36