



US00D738440S

(12) **United States Design Patent**
Cummings

(10) **Patent No.:** **US D738,440 S**

(45) **Date of Patent:** **** Sep. 8, 2015**

(54) **ELASTIC BAND TOY LAUNCHER WITH BOW CONFIGURATION**

(71) Applicant: **Peter Cummings**, Tsim Sha Tsui (HK)

(72) Inventor: **Peter Cummings**, Tsim Sha Tsui (HK)

(73) Assignee: **KMA Concepts Limited**, Tsim Sha Tsui, Kowloon (HK)

(**) Term: **14 Years**

(21) Appl. No.: **29/489,626**

(22) Filed: **May 1, 2014**

(51) **LOC (10) Cl.** **21-01**

(52) **U.S. Cl.**
USPC **D21/571**

(58) **Field of Classification Search**
USPC D21/570, 571; D22/100, 106, 107, 113;
124/17, 18, 20.1, 20.3, 23.1
CPC A63F 9/02; A63F 9/0252; F41B 5/00;
F41B 5/12; F41B 5/0094; F41B 5/1484;
F41B 7/08

See application file for complete search history.

(56) **References Cited**

U.S. PATENT DOCUMENTS

D271,411	S	*	11/1983	Adkins	D22/107
D286,659	S	*	11/1986	Chu	D21/571
8,662,060	B2	*	3/2014	Walterscheid et al.	124/20.3
8,689,773	B2	*	4/2014	Walterscheid et al.	124/23.1
2012/0060807	A1	*	3/2012	Walterscheid	124/20.3
2013/0263838	A1	*	10/2013	Cummings	124/20.1
2014/0000577	A1	*	1/2014	Cummings	124/20.1

* cited by examiner

Primary Examiner — Cynthia M Chin

(74) *Attorney, Agent, or Firm* — LaMorte & Associates, P.C.

(57) **CLAIM**

The ornamental design for an elastic band toy launcher with bow configuration, as shown and described.

DESCRIPTION

FIG. 1 is a top perspective view of an elastic band toy launcher with bow configuration;
FIG. 2 is a rear view thereof;
FIG. 3 is a front view thereof;
FIG. 4 is a top view, the bottom view being a mirror image thereof;
FIG. 5 is a left side view thereof; and,
FIG. 6 is a right side thereof.
Portions of the disclosure shown in broken lines form no part of the claimed design.

1 Claim, 6 Drawing Sheets

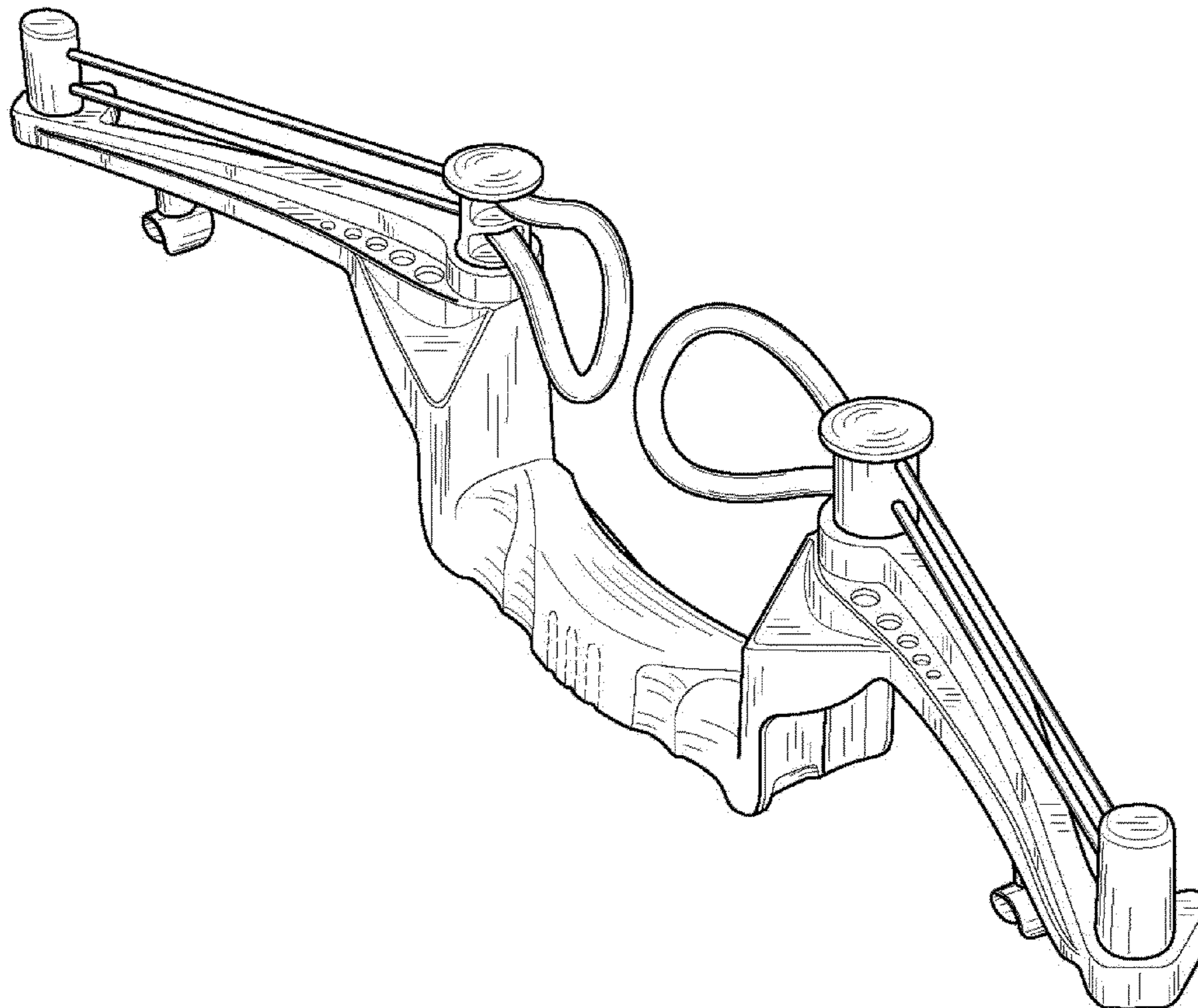

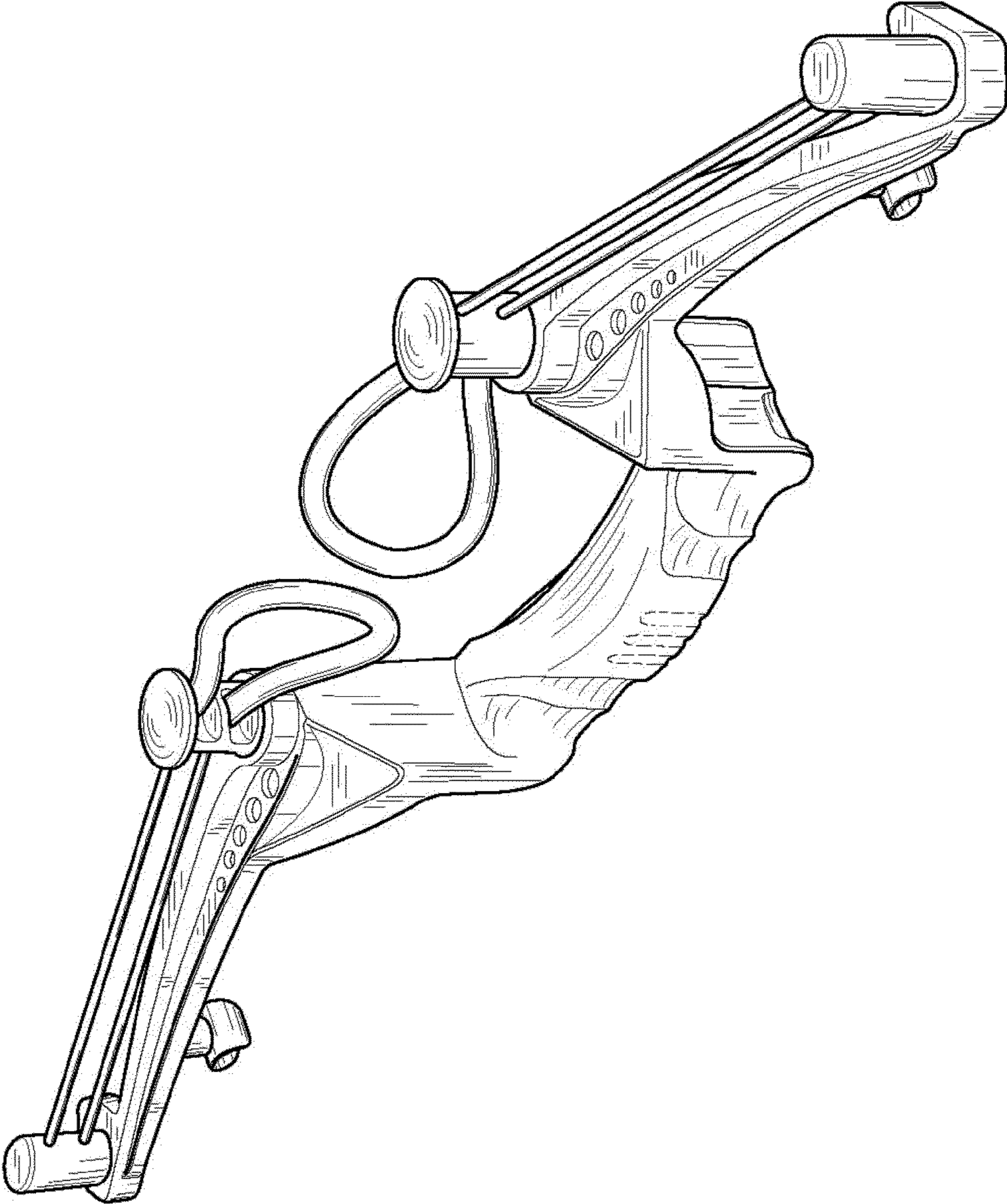

FIG. 1

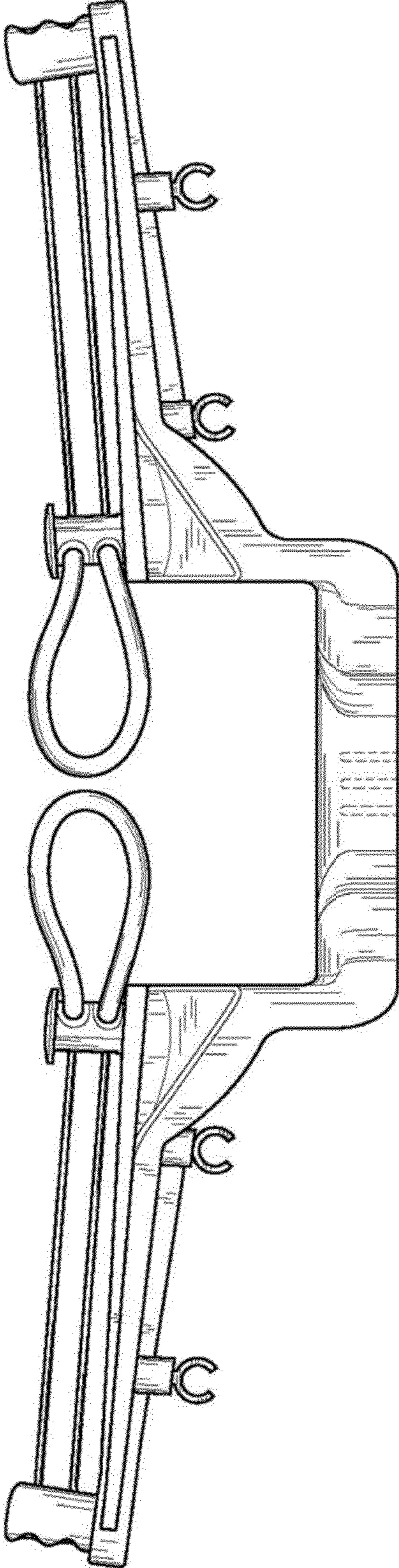

FIG. 2

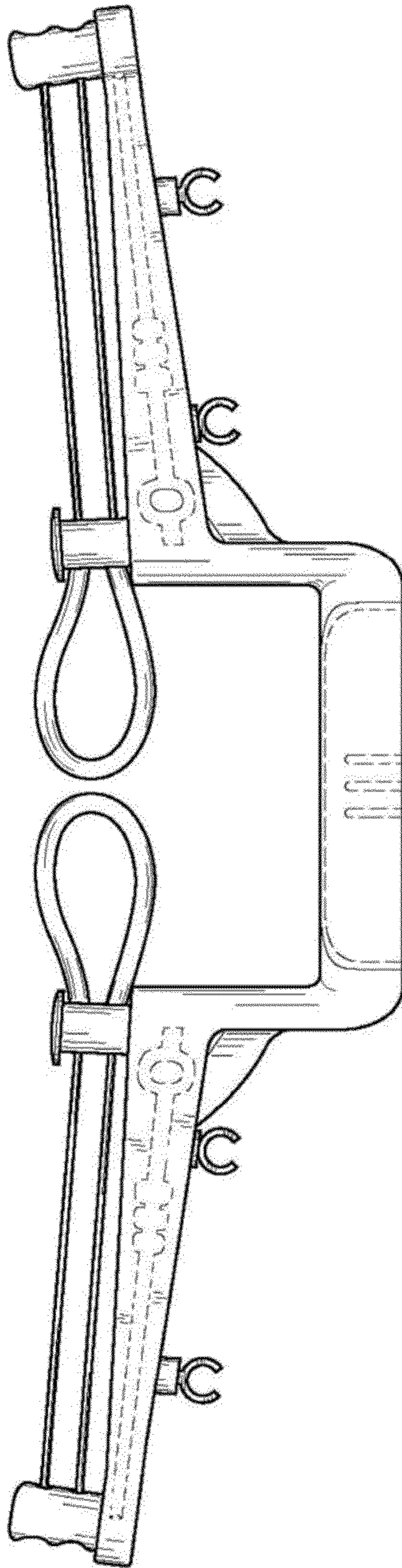

FIG. 3

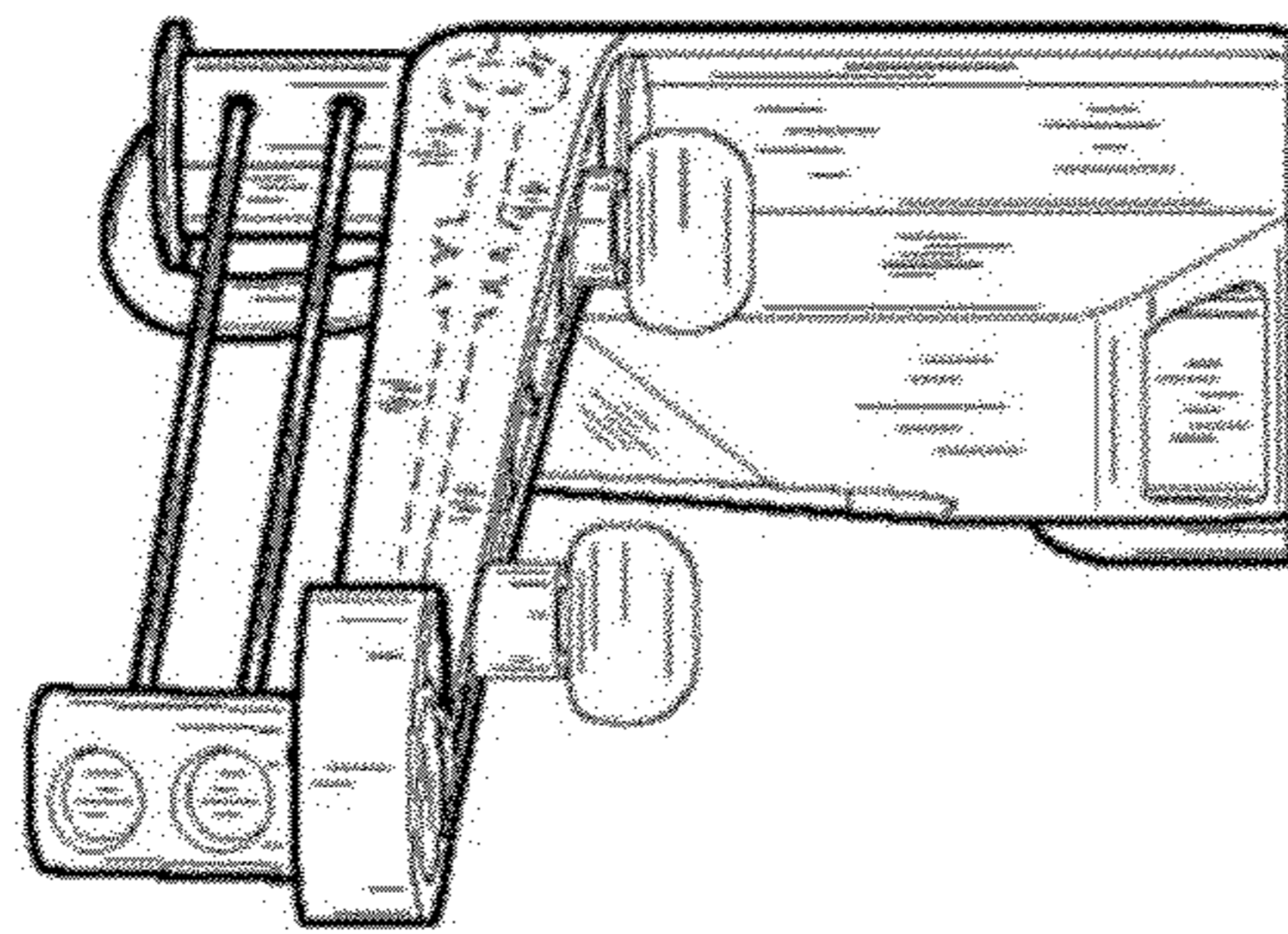

FIG. 4

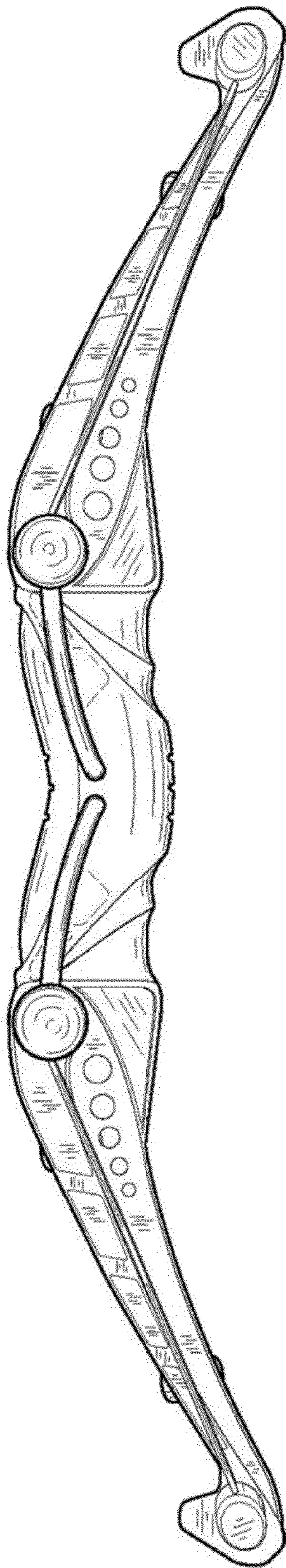

FIG. 5

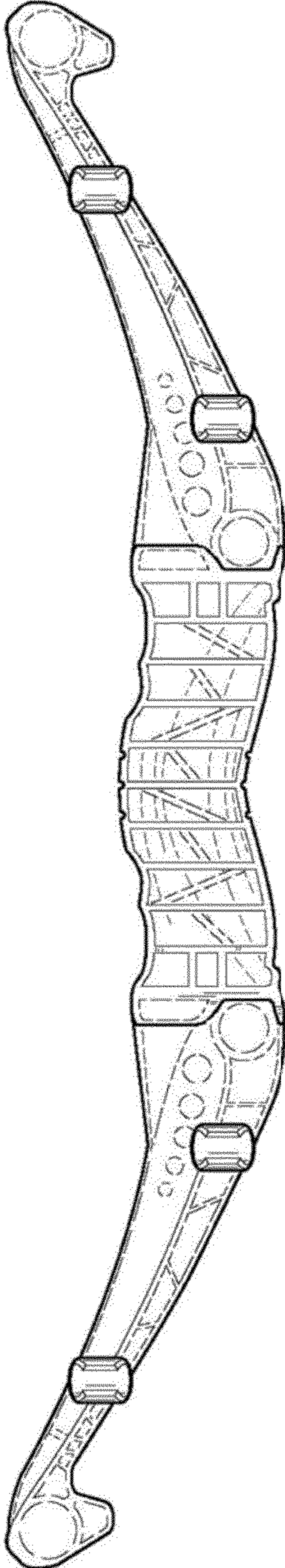

FIG. 6