



US00D738344S

(12) **United States Design Patent**
Joung et al.

(10) **Patent No.:** **US D738,344 S**
(45) **Date of Patent:** **** Sep. 8, 2015**

(54) **CELLULAR PHONE**

(71) Applicant: **LG ELECTRONICS INC.**, Seoul (KR)

(72) Inventors: **Joungyoung Joung**, Seoul (KR);
Hyunwoo Kim, Seoul (KR); **Joonhyung Kim**, Seoul (KR); **Min Kim**, Seoul (KR)

(73) Assignee: **LG Electronics Inc.**, Seoul (KR)

(**) Term: **14 Years**

(21) Appl. No.: **29/501,696**

(22) Filed: **Sep. 8, 2014**

(30) **Foreign Application Priority Data**

Mar. 14, 2014 (KR) 30-2014-0012866

(51) **LOC (10) Cl.** **14-03**

(52) **U.S. Cl.**
USPC **D14/138 AD**

(58) **Field of Classification Search**

USPC D14/138 AD, 138 G, 341-347, 138 AA,
D14/138 AB, 138 R, 138 AC, 138 C, 138,
D14/137, 147, 218, 247, 248, 191,
D14/203.1-203.8, 496; D13/168; D21/324,
D21/329, 517; 455/566, 575.1, 575.3,
455/575.4; D10/65, 78, 104.1, 104.2
CPC H04M 1/0202; H04M 1/0235; H04M
1/0237; H04M 1/0239; H04M 2250/52;
H04M 1/0266; H04M 1/0268; H04M 1/0295;
H04M 2250/22; G06F 1/1626; G06F 1/1624
See application file for complete search history.

(56) **References Cited**

U.S. PATENT DOCUMENTS

D648,300 S * 11/2011 Park et al. D14/138 G
D654,074 S * 2/2012 Wood et al. D14/341

(Continued)

FOREIGN PATENT DOCUMENTS

CN 302518298 * 7/2013
EM 002308890-0005 * 12/2013

OTHER PUBLICATIONS

HTC Max 4G, announced Nov. 2008, [online], [retrieved on Nov. 14, 2008]. Retrieved from Internet ,<URL: http://www.gsmarena.com>.*

(Continued)

Primary Examiner — Bridget L Eland

Assistant Examiner — Lauren McVey

(74) *Attorney, Agent, or Firm* — Morgan, Lewis & Bockius LLP

(57) **CLAIM**

The ornamental design for a cellular phone, as shown and described.

DESCRIPTION

FIG. 1 is a front, right side, perspective view of a cellular phone showing our new design;
FIG. 2 is a front view thereof;
FIG. 3 is a rear view thereof;
FIG. 4 is a left side view thereof;
FIG. 5 is a right side view thereof;
FIG. 6 is a top view thereof;
FIG. 7 is a bottom view thereof;
FIG. 8 is a front, right side, perspective view thereof shown with the rear cover slid to an alternate state;
FIG. 9 is a front view thereof shown with the rear cover slid to an alternate state;
FIG. 10 is a rear view thereof shown with the rear cover slid to an alternate state;
FIG. 11 is a left side view thereof shown with the rear cover slid to an alternate state;
FIG. 12 is a right side view thereof shown with the rear cover slid to an alternate state;
FIG. 13 is a top view thereof shown with the rear cover slid to an alternate state; and,
FIG. 14 is a bottom view thereof shown with the rear cover slid to an alternate state.
The broken lines shown in the figures that are immediately adjacent to the shaded areas and define unshaded regions, represent the bounds of the claim, while all other broken lines are directed to environment; the broken lines form no part of the claimed design.

1 Claim, 12 Drawing Sheets

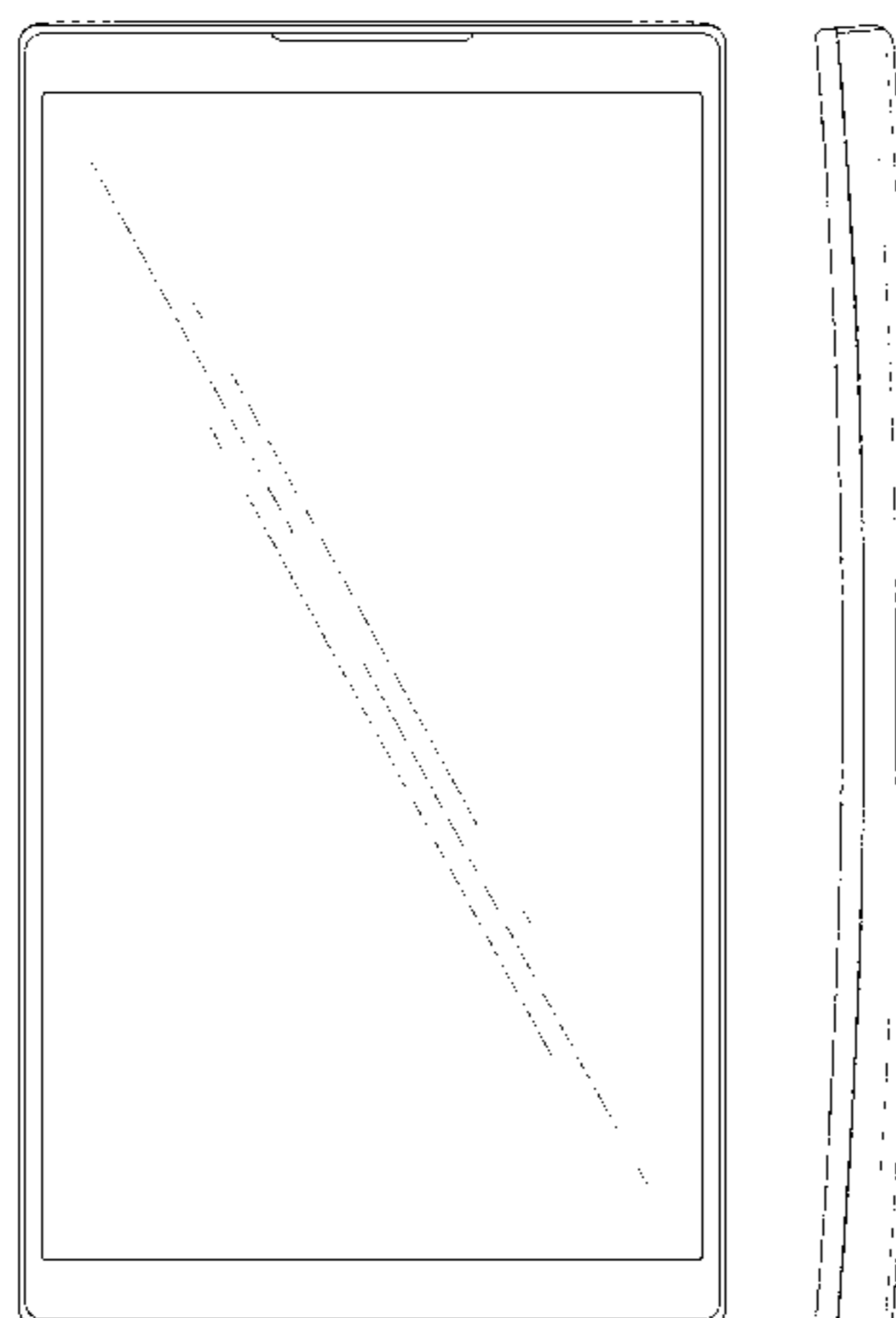

(56)

References Cited

U.S. PATENT DOCUMENTS

D671,905 S * 12/2012 Mauritzson D14/138 G
 D673,131 S * 12/2012 Sugiyama D14/138 G
 8,405,571 B2 * 3/2013 Chung 345/1.1
 D700,589 S * 3/2014 Yoo et al. D14/138 G
 D703,176 S * 4/2014 Yoo et al. D14/138 G
 D703,177 S * 4/2014 Park et al. D14/138 G
 D703,178 S * 4/2014 Park et al. D14/138 G
 D703,632 S * 4/2014 Lim et al. D14/138 G
 D706,238 S * 6/2014 Kim et al. D14/138 G
 D712,368 S * 9/2014 Hibi D14/138 G
 D712,865 S * 9/2014 Mauritzson et al. D14/138 G
 D713,373 S * 9/2014 Hibi D14/138 G
 D716,251 S * 10/2014 Choi et al. D14/138 G
 D717,263 S * 11/2014 Wozniak D14/138 G
 D717,265 S * 11/2014 Zhao D14/138 G
 D721,344 S * 1/2015 Lee et al. D14/138 G
 D721,347 S * 1/2015 Lee et al. D14/138 G
 D730,859 S * 6/2015 Kaneta D14/138 G
 D730,863 S * 6/2015 Yamagishi et al. D14/138 G

2007/0287512 A1* 12/2007 Kilpi et al. 455/575.1
 2010/0267428 A1* 10/2010 Wang et al. 455/575.4
 2011/0045879 A1* 2/2011 Kim et al. 455/575.4
 2011/0081953 A1* 4/2011 Higuchi 455/566
 2014/0184471 A1* 7/2014 Martynov et al. 345/1.2

OTHER PUBLICATIONS

Sony Xperia ion LTE, announced Jan. 2012, [online], [retrieved on Dec. 11, 2012]. Retrieved from Internet ,<URL: <http://www.gsmarena.com>>.*
 Sony Xperia C3, announced Jul. 2014, [online], [retrieved on Mar. 31, 2015]. Retrieved from Internet ,<URL: <http://www.gsmarena.com>>.*
 LG Optimus 3D Max P720, announced Feb. 2012, [online], [retrieved on Mar. 15, 2012]. Retrieved from Internet ,<URL: <http://www.gsmarena.com>>.*
 Sony Xperia T2 Ultra dual, announced Jan. 2014, [online], [retrieved on May 30, 2014]. Retrieved from Internet ,<URL: <http://www.gsmarena.com>>.*

* cited by examiner

FIG. 1

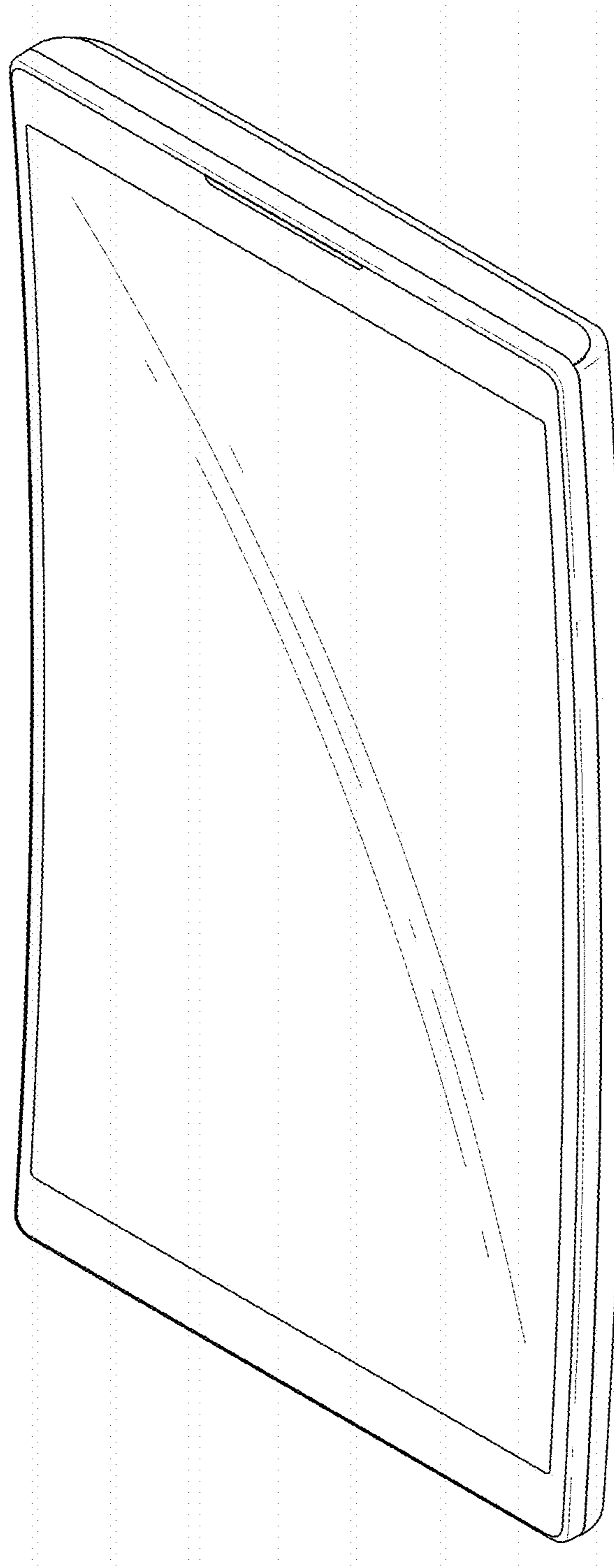

FIG. 2

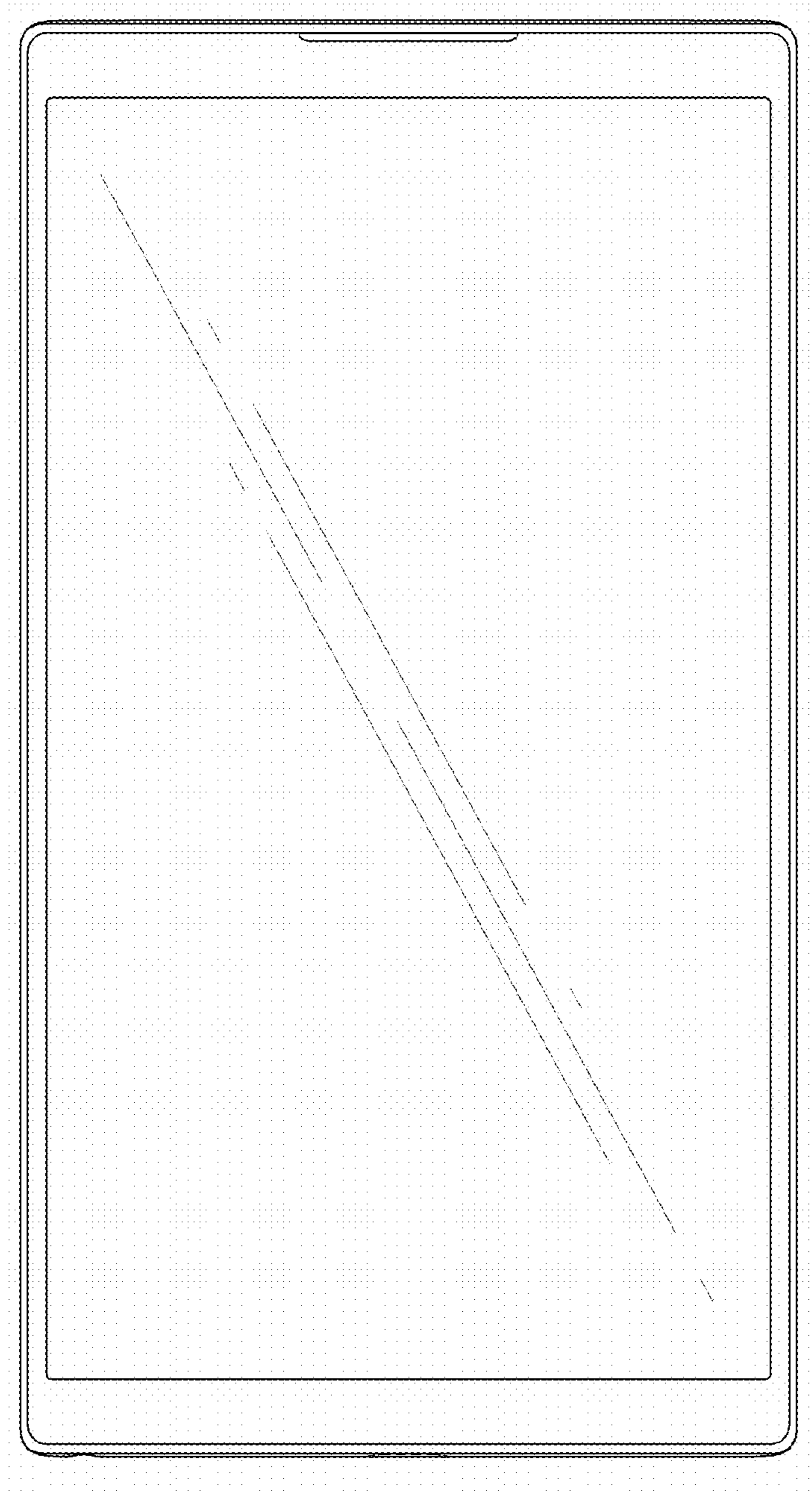

FIG. 3

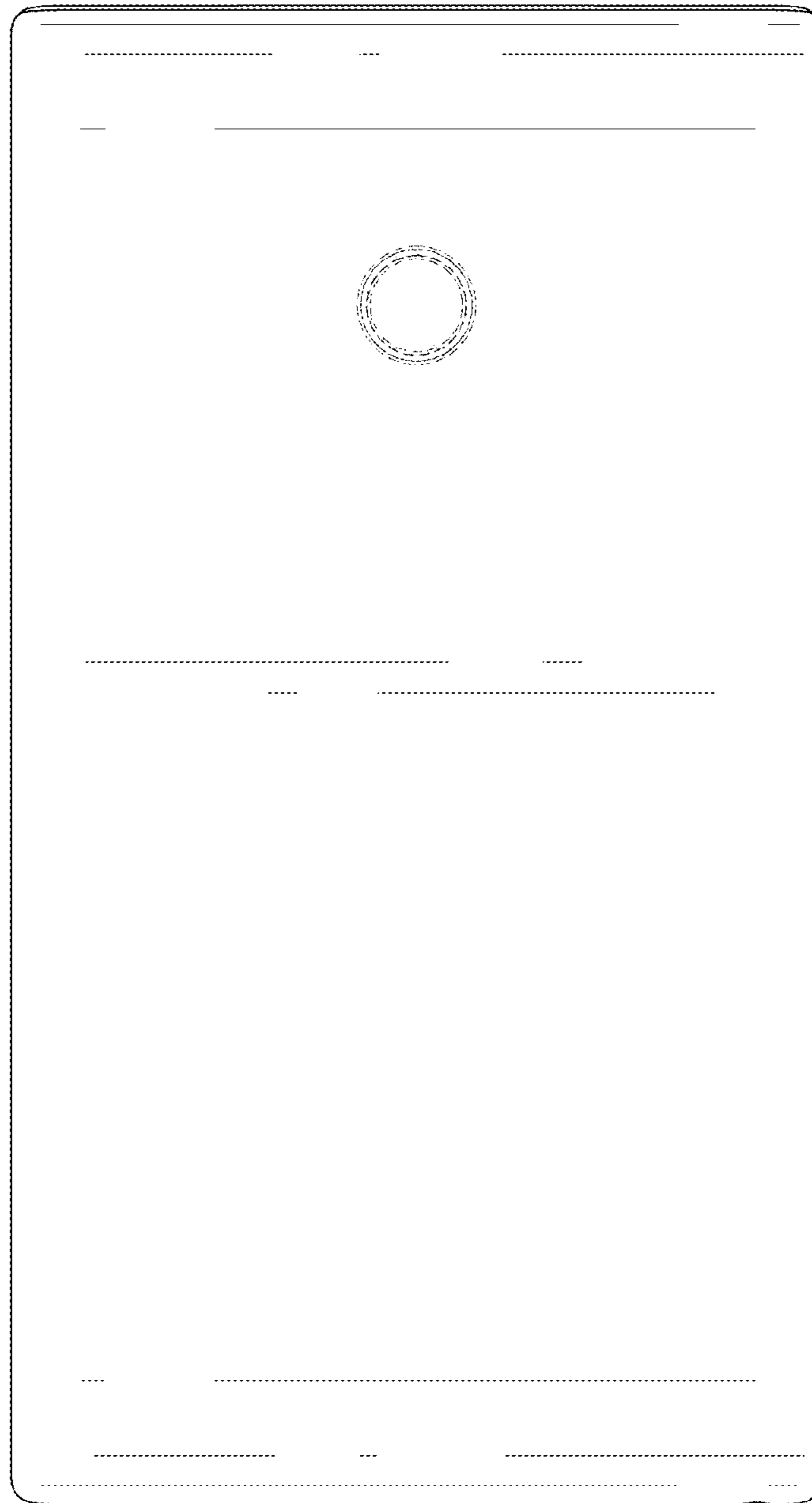

FIG. 4

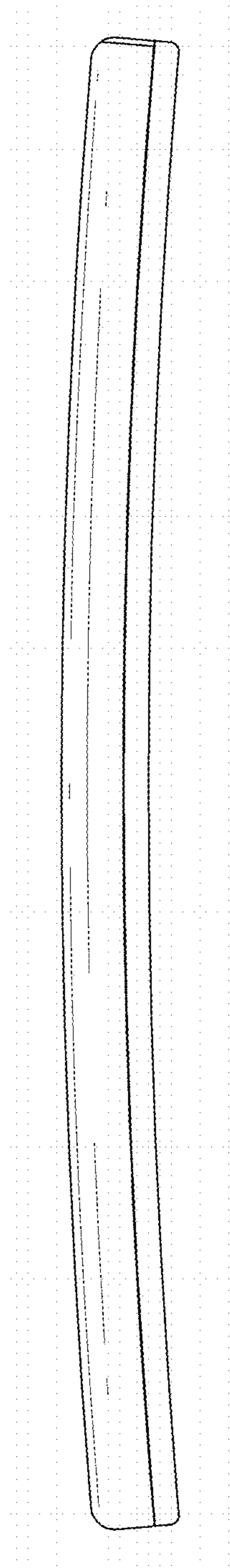

FIG. 5

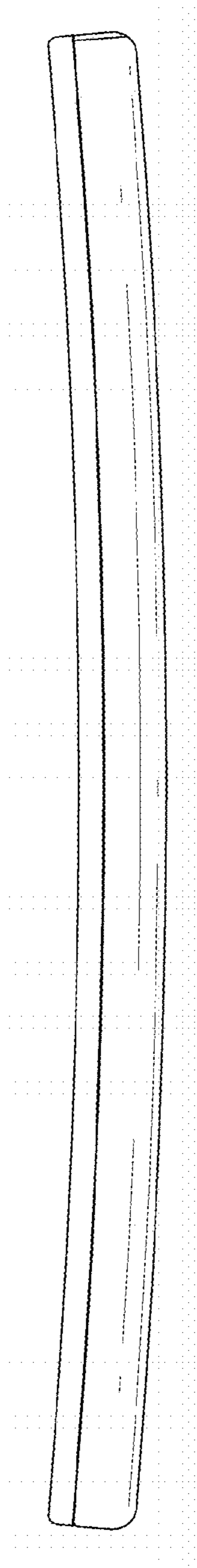

FIG. 6

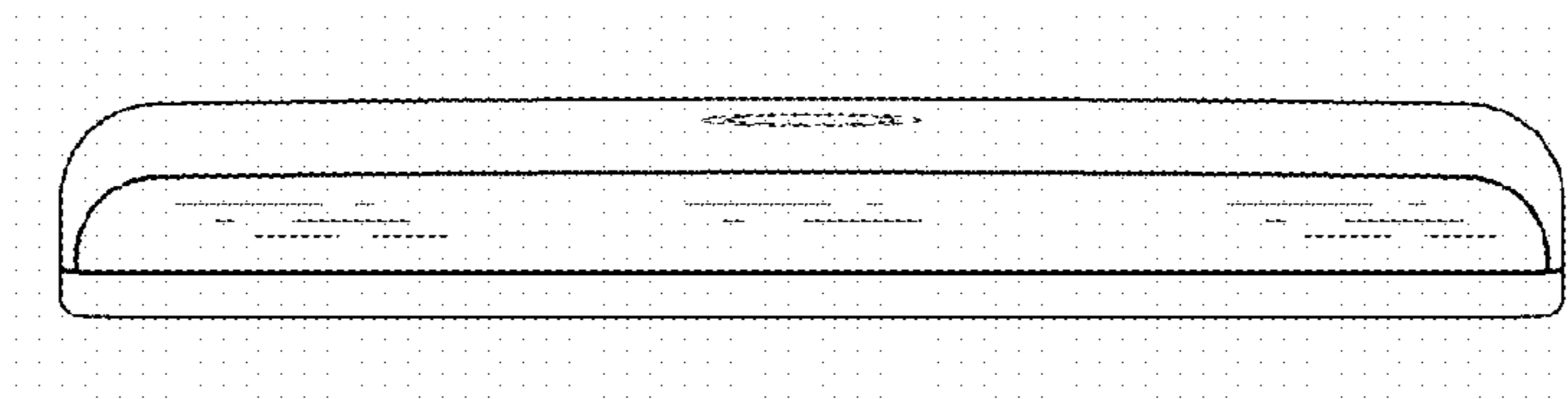

FIG. 7

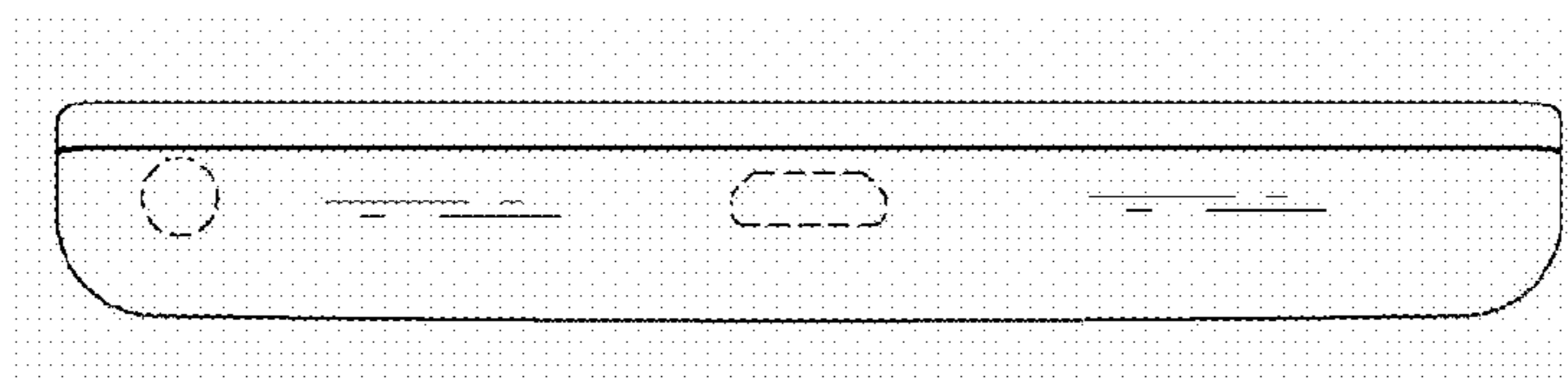

FIG. 8

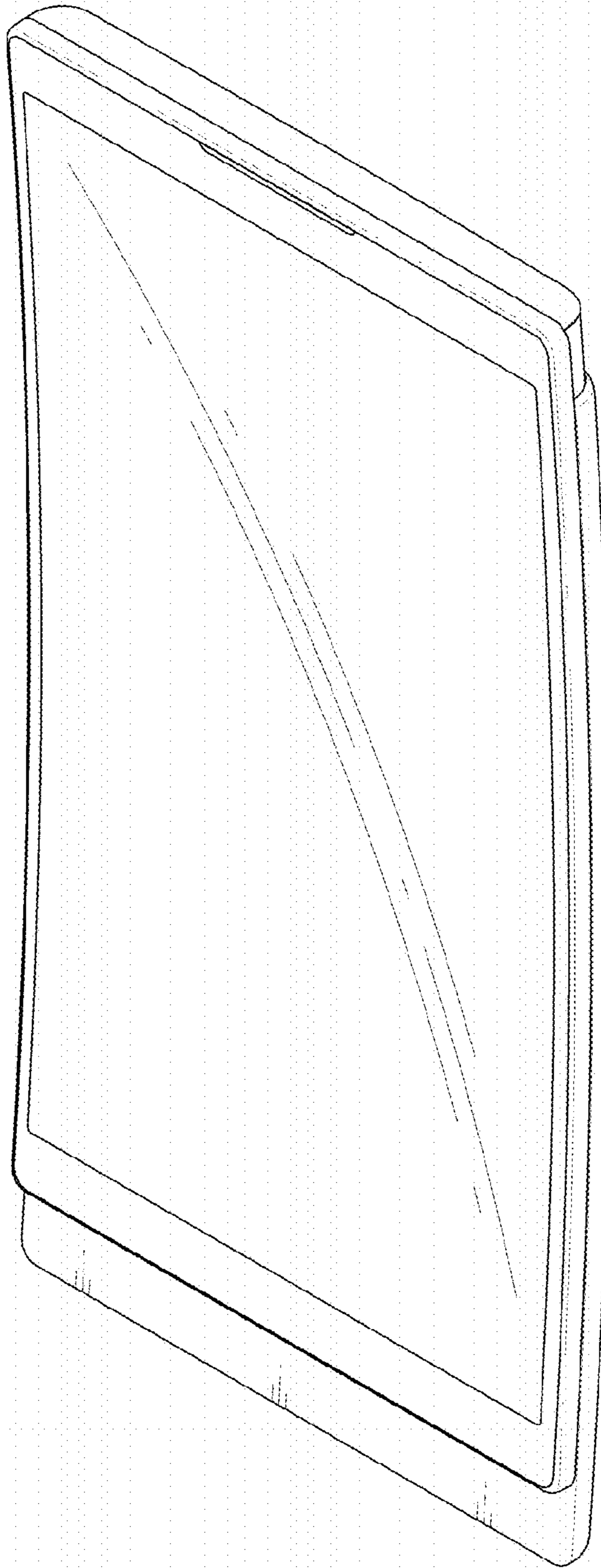

FIG. 9

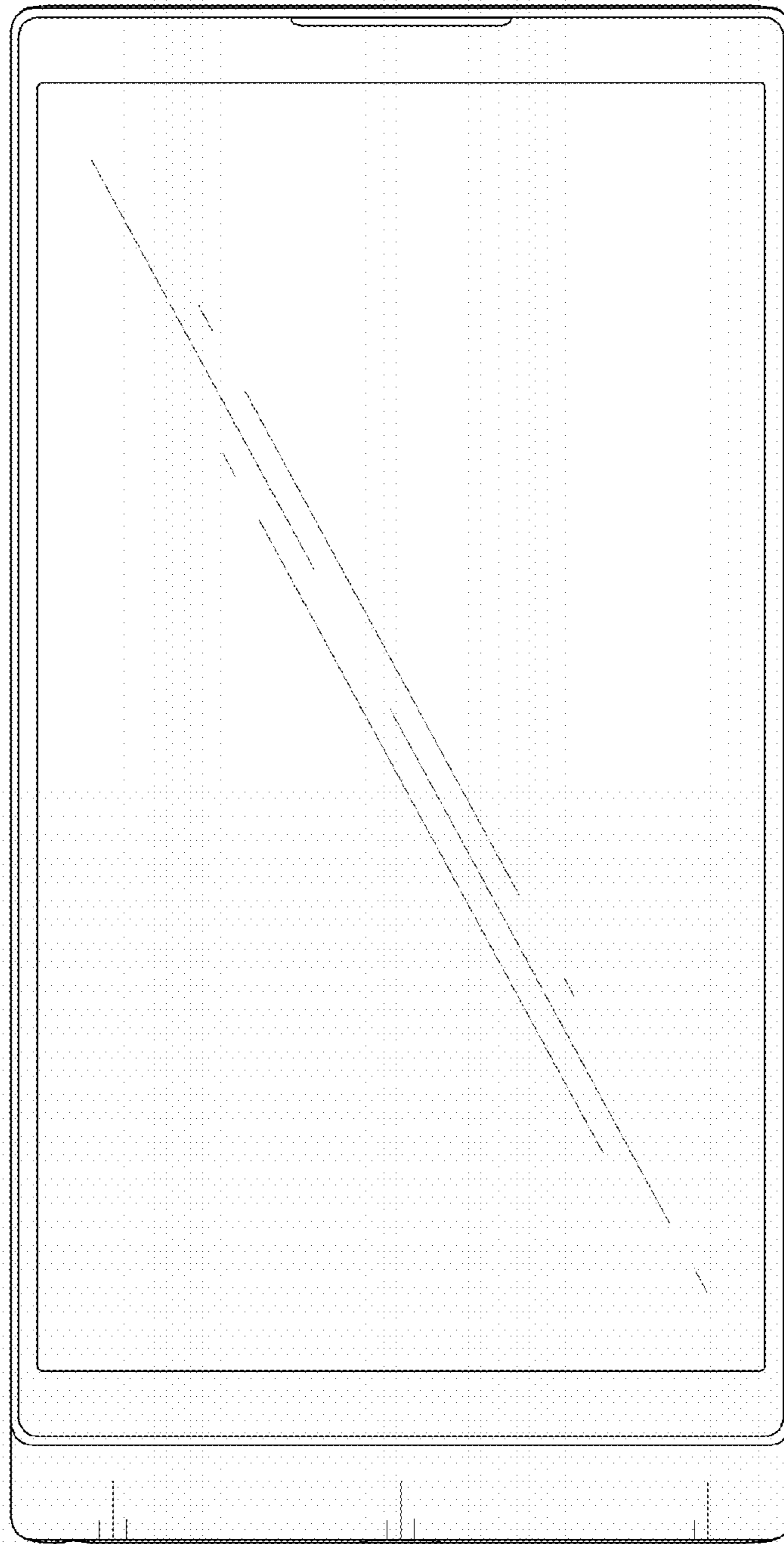

FIG. 10

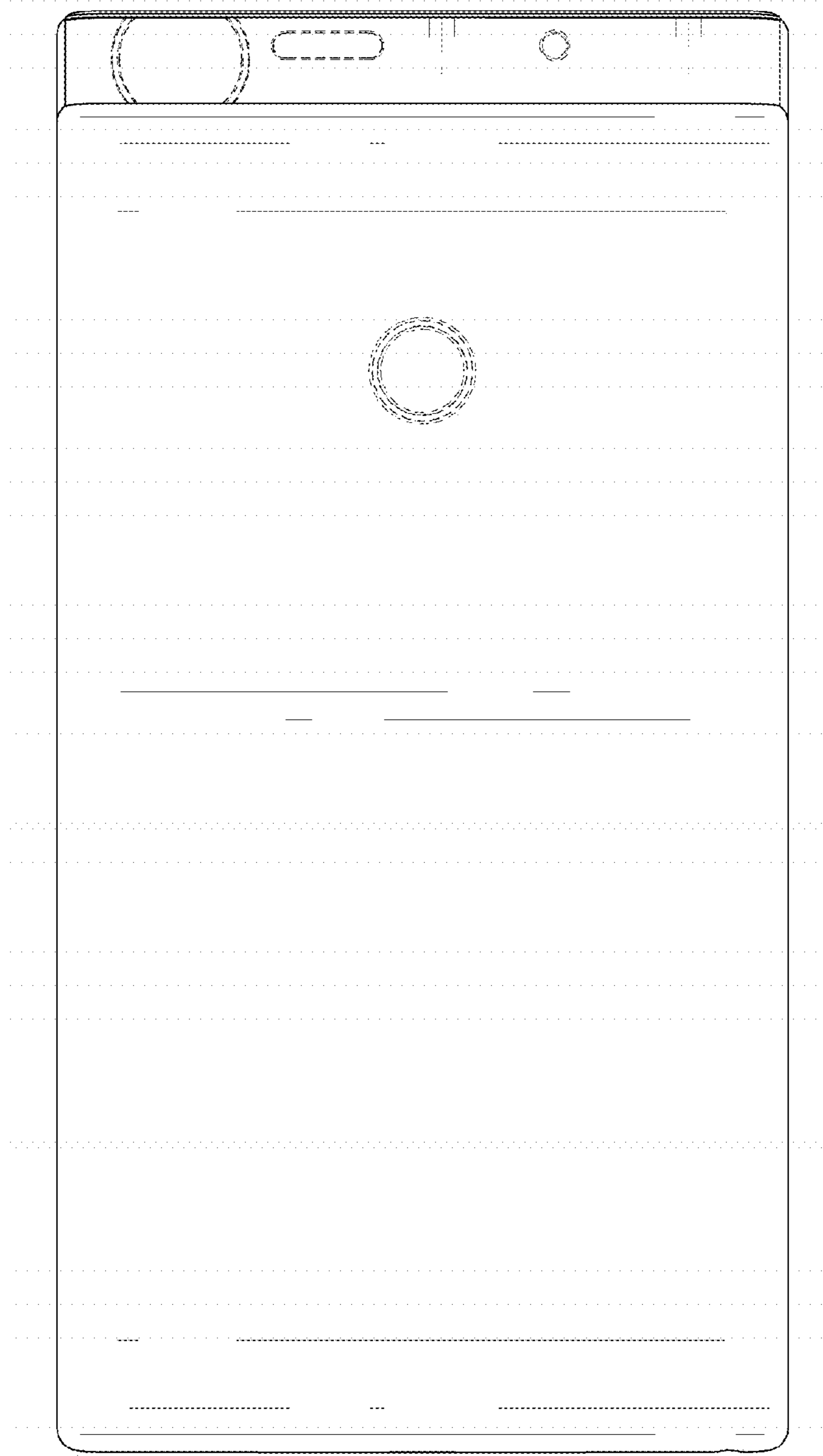

FIG. 11

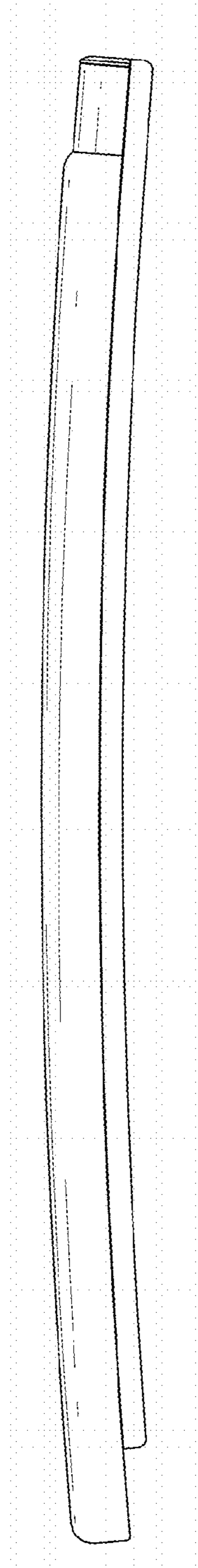

FIG. 12

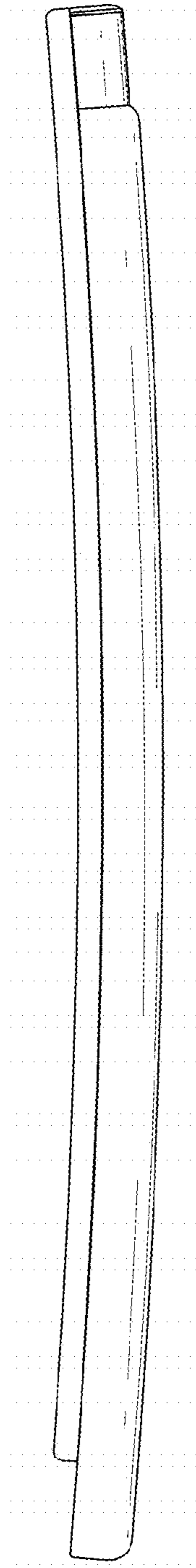

FIG. 13

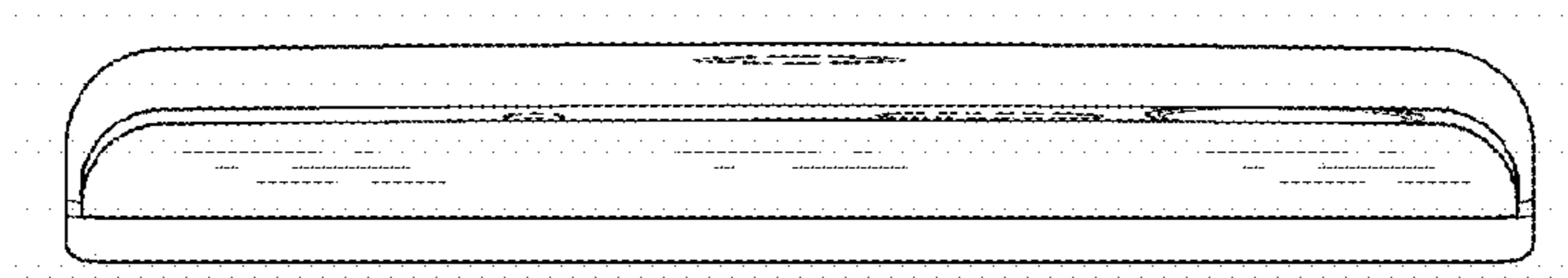

FIG. 14

