



US00D738334S

(12) **United States Design Patent**  
**Shin et al.**

(10) **Patent No.:** **US D738,334 S**

(45) **Date of Patent:** **\*\* Sep. 8, 2015**

(54) **TELEVISION RECEIVER**

(71) Applicant: **Samsung Electronics Co., Ltd.**,  
Suwon-si, Gyeonggi-do (KR)

(72) Inventors: **Rina Shin**, Seoul (KR); **Hyung-Ho Hwangbo**, Seoul (KR); **Hae-Sung Park**, Seoul (KR); **Christopher Edward Bangle**, Clavesana (IT); **Nam-Hyun Park**, Namyangju-Si (KR); **Do-Sung Jung**, Seoul (KR)

(73) Assignee: **SAMSUNG ELECTRONICS CO., LTD.** (KR)

(\*\*) Term: **14 Years**

(21) Appl. No.: **29/472,270**

(22) Filed: **Nov. 11, 2013**

(30) **Foreign Application Priority Data**

Jun. 5, 2013 (KR) ..... 30-2013-0029372

(51) **LOC (10) Cl.** ..... **14-03**

(52) **U.S. Cl.**  
USPC ..... **D14/126**

(58) **Field of Classification Search**  
USPC ..... D14/371-382, 125-134, 239, 448-452,  
D14/136, 341, 479, 389, 397, 308, 412, 157,  
D14/155, 511, 432, 498, 138 AD, 336, 337,  
D14/447; 361/679.02; 348/836, 838, 180,  
348/184, 325, 739; 248/917-924, 465;  
345/104; D6/300, 301, 302, 308,  
D6/310-314; D8/363; D20/39, 41, 42

CPC ..... G01F 1/1601  
See application file for complete search history.

(56) **References Cited**

U.S. PATENT DOCUMENTS

D303,255 S *	9/1989	Bratasevec .....	D14/371
D473,867 S *	4/2003	Lin .....	D14/371
D518,006 S *	3/2006	Lin .....	D14/126
D529,010 S *	9/2006	Imboden .....	D14/126
D536,310 S *	2/2007	Kao .....	D14/126
D580,384 S *	11/2008	Katayama et al. ....	D14/126
D586,307 S *	2/2009	Chu .....	D14/134
D596,596 S *	7/2009	Honda .....	D14/126
D709,470 S *	7/2014	Ryu et al. ....	D14/126
D725,620 S *	3/2015	Li et al. ....	D14/126

\* cited by examiner

*Primary Examiner* — Susan Bennett Hattan

*Assistant Examiner* — Brett Miller

(74) *Attorney, Agent, or Firm* — Cantor Colburn LLP

(57) **CLAIM**

The ornamental design for a television receiver, as shown and described.

**DESCRIPTION**

FIG. 1 is a perspective view of a television receiver, showing our new design;

FIG. 2 is a front view thereof;

FIG. 3 is a rear view thereof;

FIG. 4 is a side view thereof;

FIG. 5 is another side view thereof;

FIG. 6 is a top plan view thereof;

FIG. 7 is a bottom plan view thereof; and,

FIG. 8 is a rear perspective view thereof.

The shade lines in the figures show contour and not surface ornamentation.

**1 Claim, 6 Drawing Sheets**

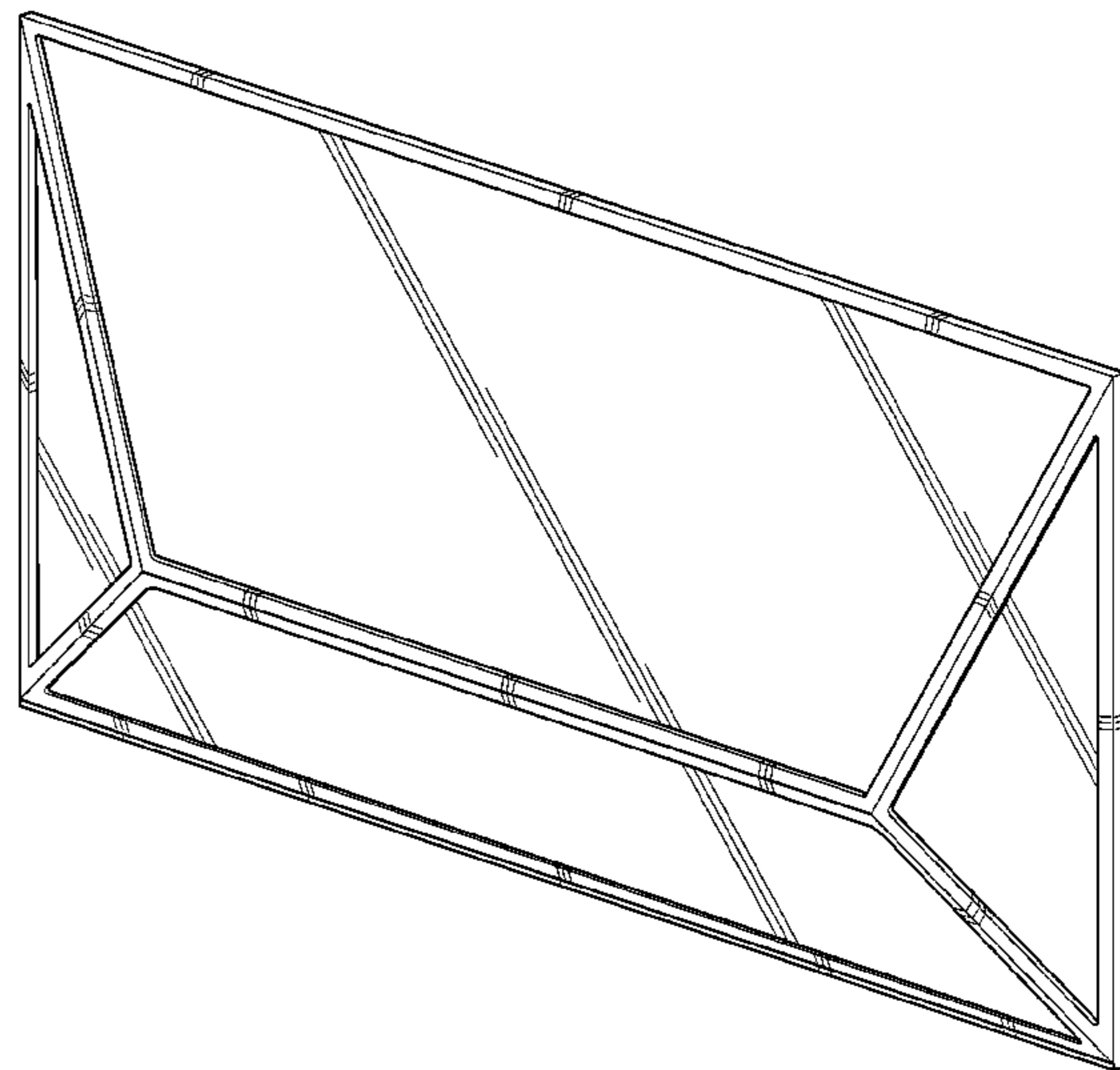
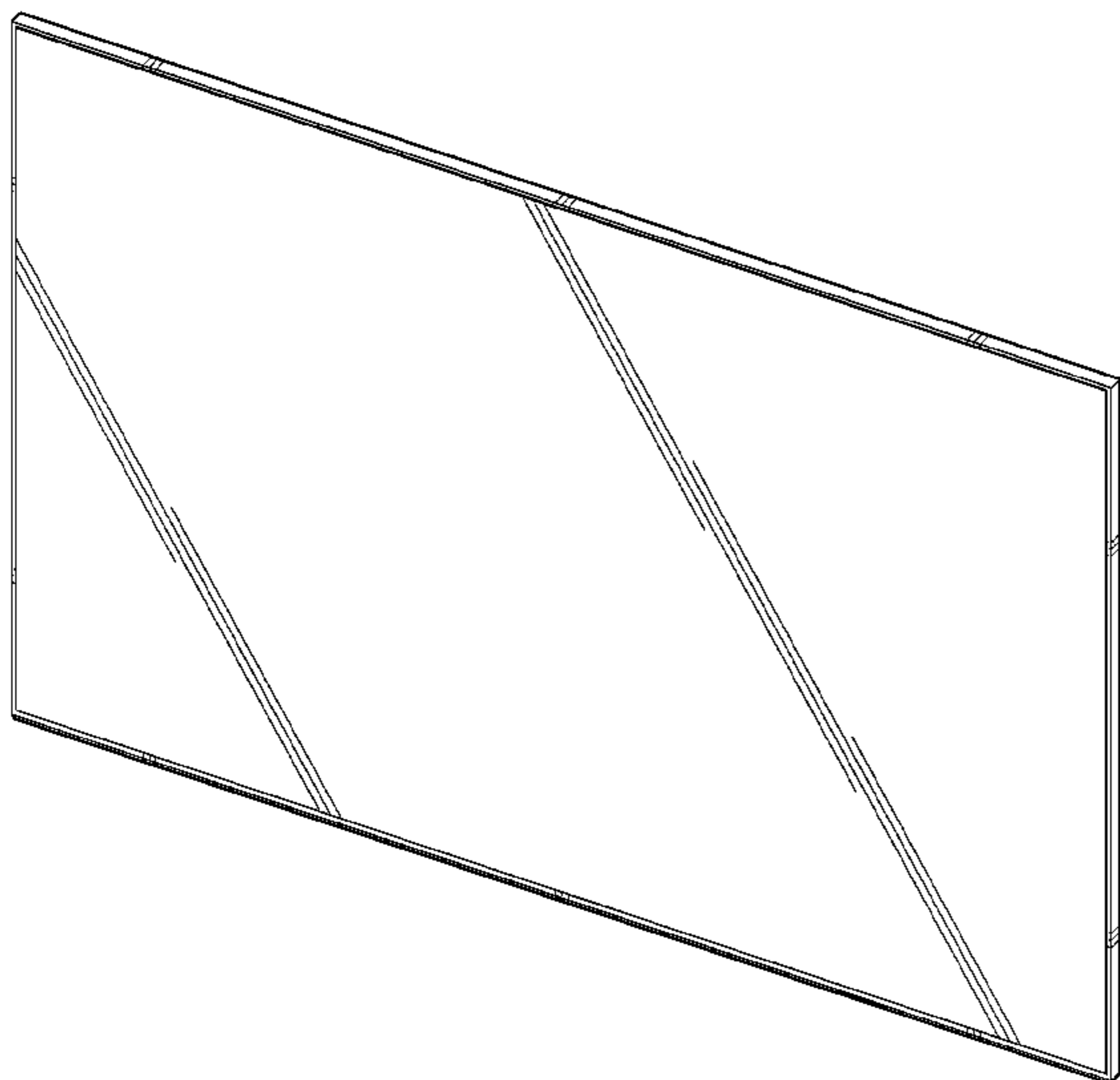

FIG. 1

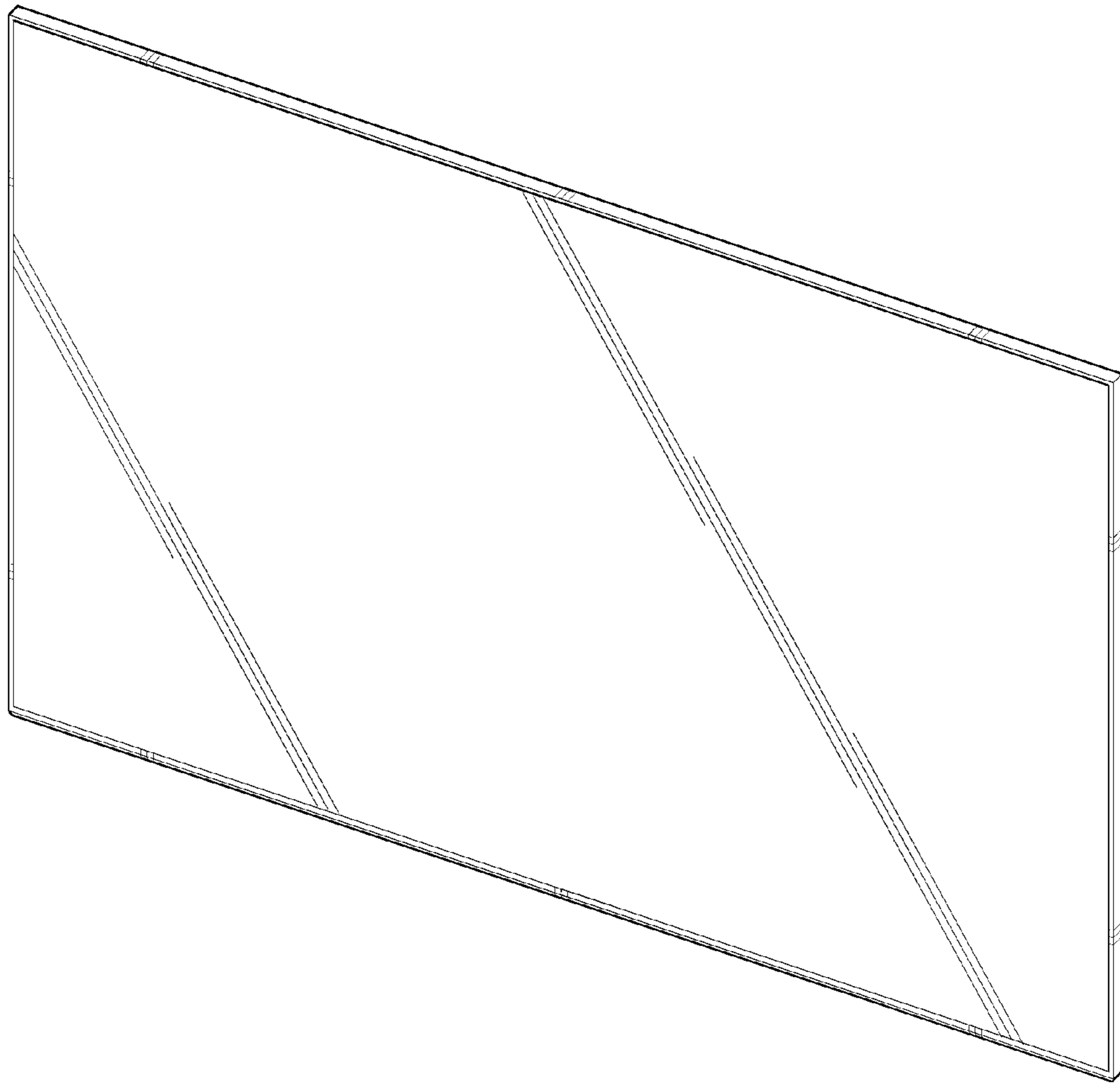

FIG. 2

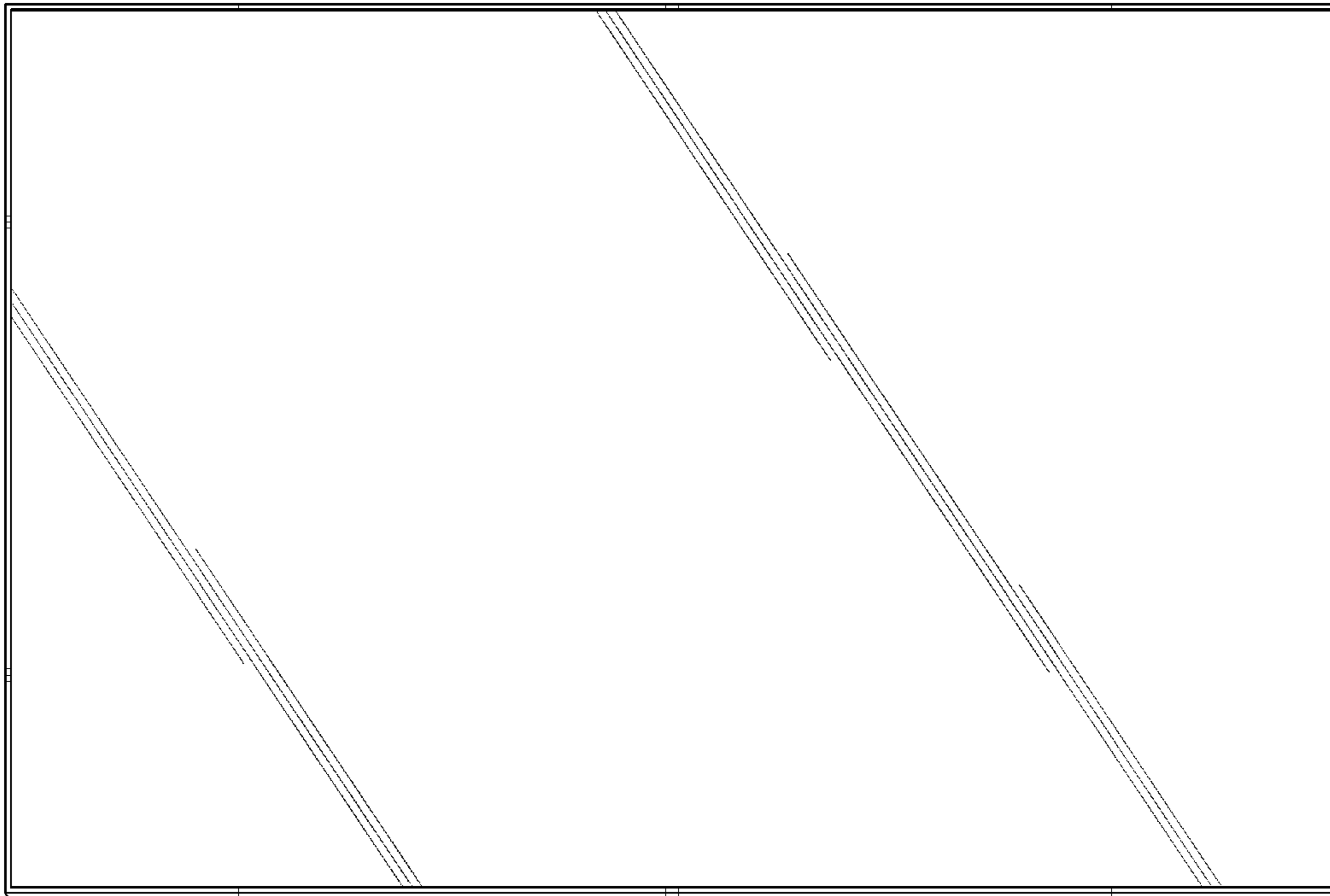

FIG. 3

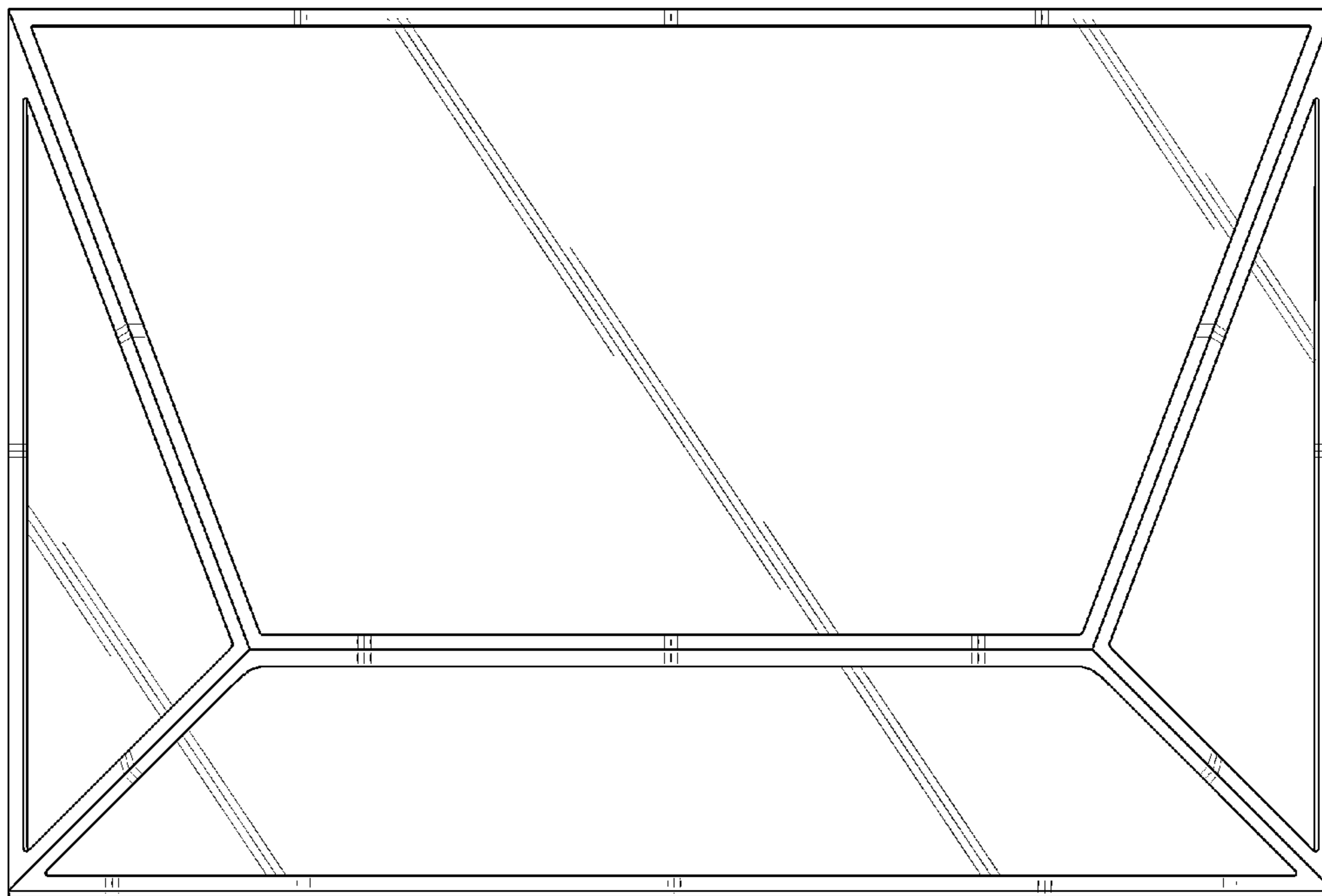

FIG. 4

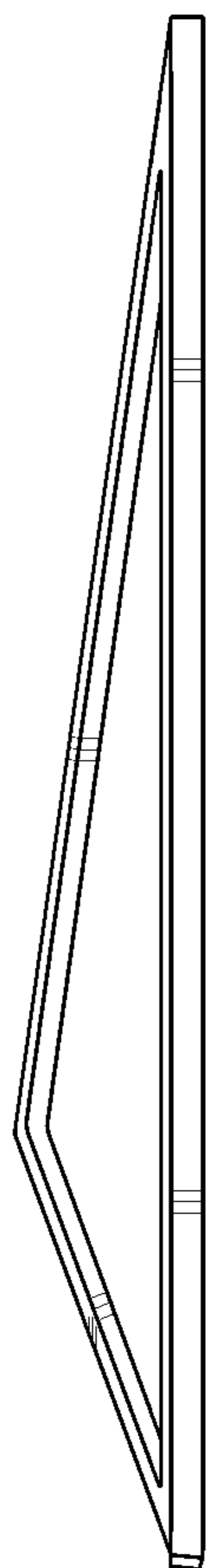

FIG. 5

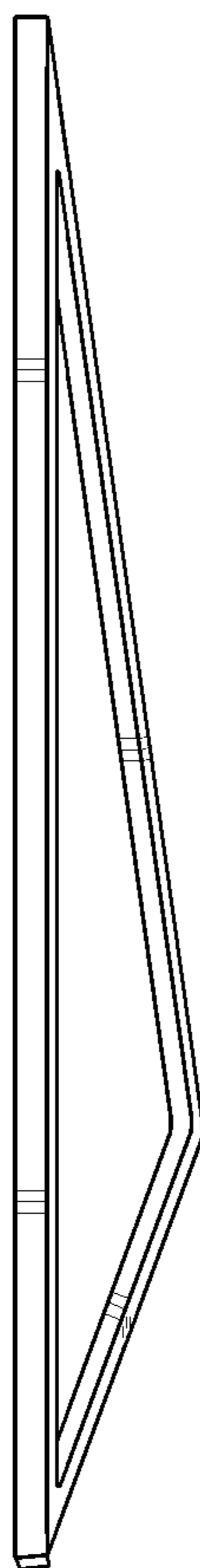

FIG. 6



FIG. 7

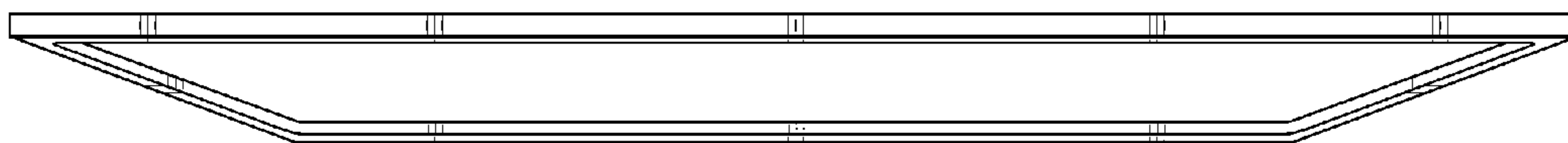

FIG. 8

