



US00D738239S

(12) **United States Design Patent**  
**Payne**

(10) **Patent No.:** **US D738,239 S**  
(45) **Date of Patent:** **\*\* Sep. 8, 2015**

(54) **CABLE MAPPER**

(74) *Attorney, Agent, or Firm* — Hartman & Citrin LLC

(71) Applicant: **Southwire Company, LLC**, Carrollton, GA (US)

(57) **CLAIM**  
The ornamental design for a cable mapper, as shown and described.

(72) Inventor: **John Lawrence Payne**, Newnan, GA (US)

**DESCRIPTION**

(73) Assignee: **Southwire Company, LLC**, Carrollton, GA (US)

FIG. 1 is a perspective view of a first embodiment of a cable mapper according to my design;  
FIG. 2 is a front view of the cable mapper according to the first embodiment;  
FIG. 3 is a rear view of the cable mapper according to the first embodiment;  
FIG. 4 is a side view of the cable mapper according to the first embodiment;  
FIG. 5 is a side view of the cable mapper according to the first embodiment;  
FIG. 6 is a top view of the cable mapper according to the first embodiment;  
FIG. 7 is a bottom view of the cable mapper according to the first embodiment;  
FIG. 8 is a perspective view of a second embodiment of a cable mapper according to my design;  
FIG. 9 is a front view of the cable mapper according to the second embodiment;  
FIG. 10 is a rear view of the cable mapper according to the second embodiment;  
FIG. 11 is a side view of the cable mapper according to the second embodiment;  
FIG. 12 is a side view of the cable mapper according to the second embodiment;  
FIG. 13 is a top view of the cable mapper according to the second embodiment; and,  
FIG. 14 is a bottom view of the cable mapper according to the second embodiment.

(\*\*) Term: **14 Years**

(21) Appl. No.: **29/504,886**

(22) Filed: **Oct. 10, 2014**

(51) **LOC (10) Cl.** ..... **10-04**

(52) **U.S. Cl.**  
USPC ..... **D10/78**

(58) **Field of Classification Search**  
USPC ..... D10/46, 75-80  
CPC ..... G01P 1/02-1/127; G01B 19/041-19/048;  
G06F 1/1626; G06F 1/1613; G01R 29/00-29/26; G01R 31/02-31/31937; H01R 2201/04; H01R 2201/06; H01R 2201/16; H01R 2201/20; H04M 1/24  
See application file for complete search history.

(56) **References Cited**

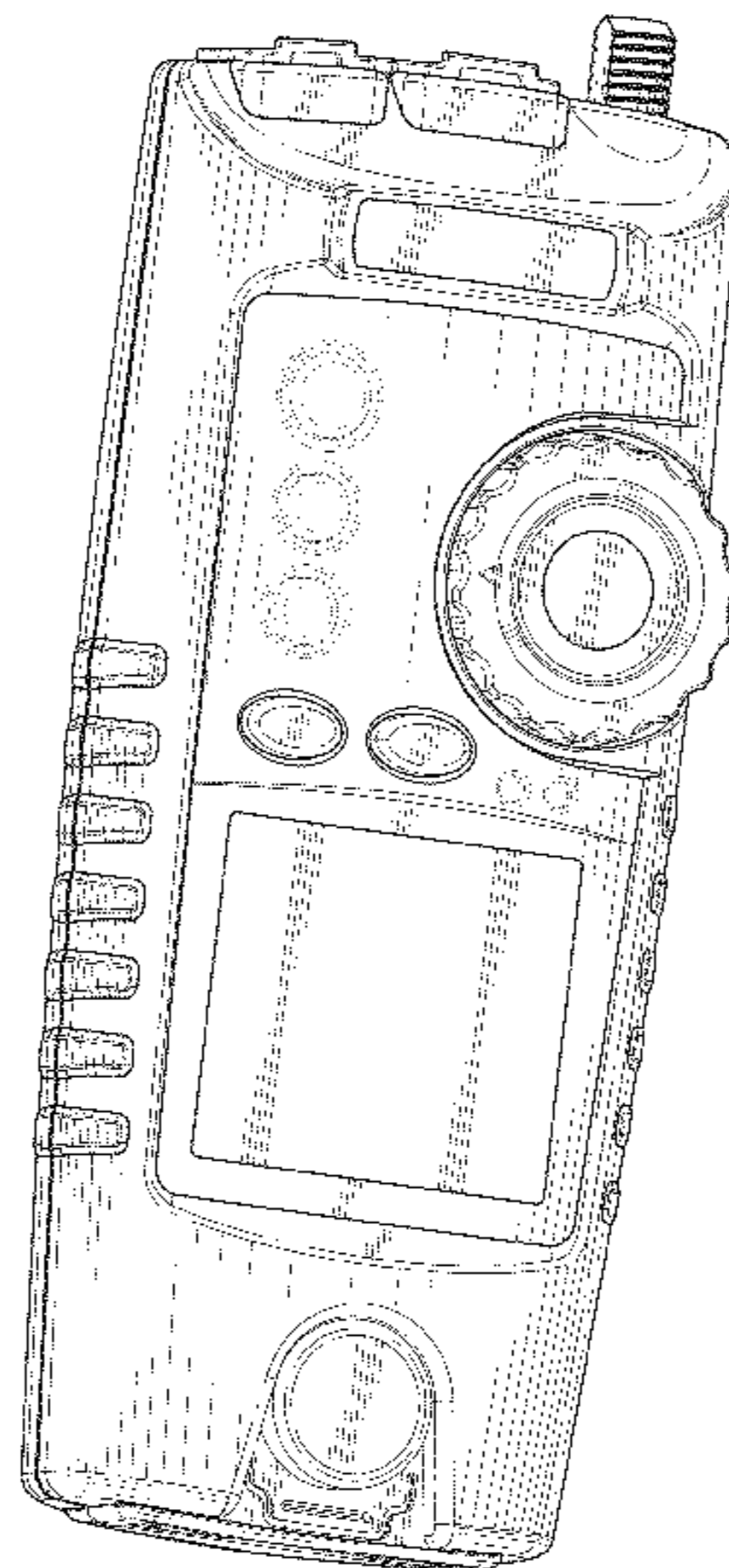
U.S. PATENT DOCUMENTS

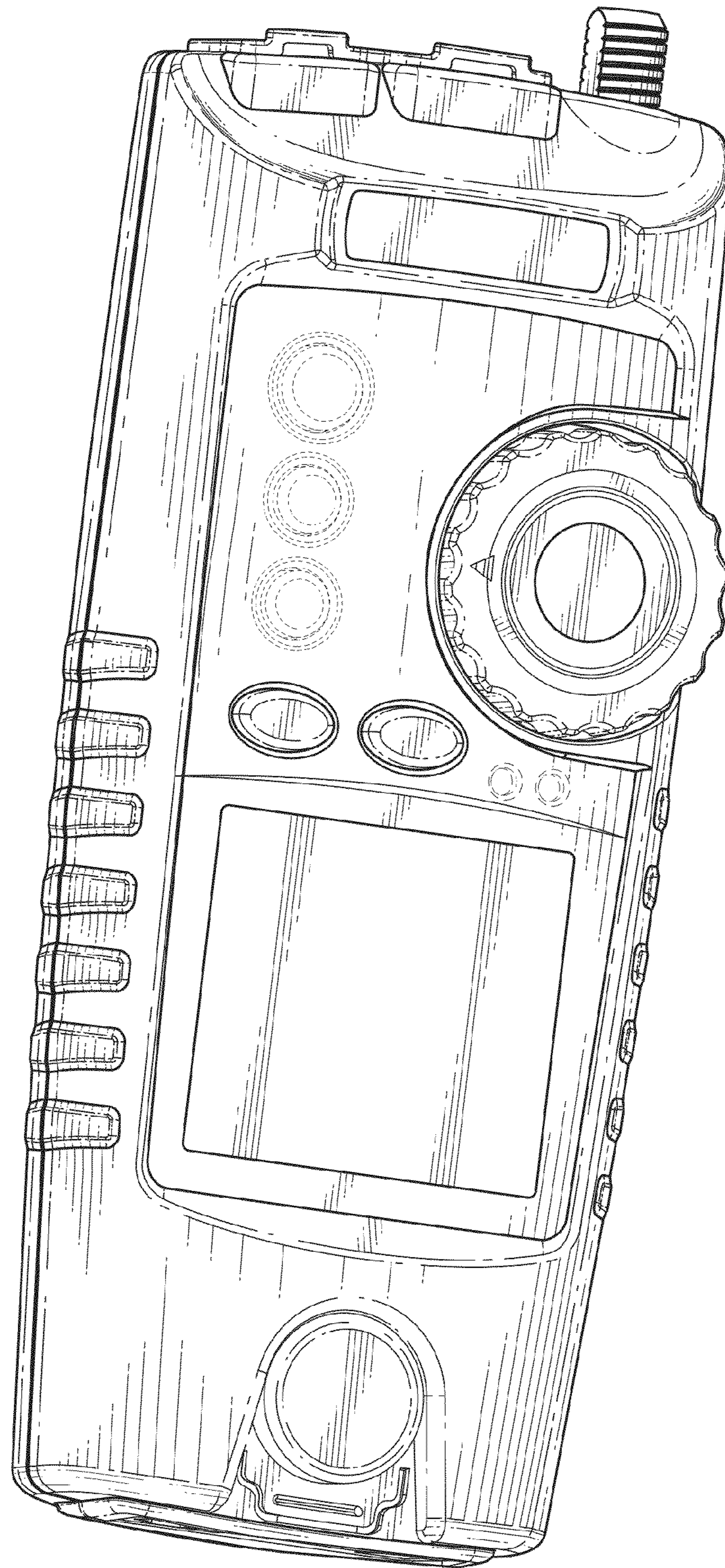
D364,105 S *	11/1995	Omuro et al.	.....	D10/78
6,611,147 B2 *	8/2003	White et al.	.....	324/539
D512,333 S *	12/2005	Blacken et al.	.....	D10/78
D698,673 S *	2/2014	Igelmund	.....	D10/78

\* cited by examiner

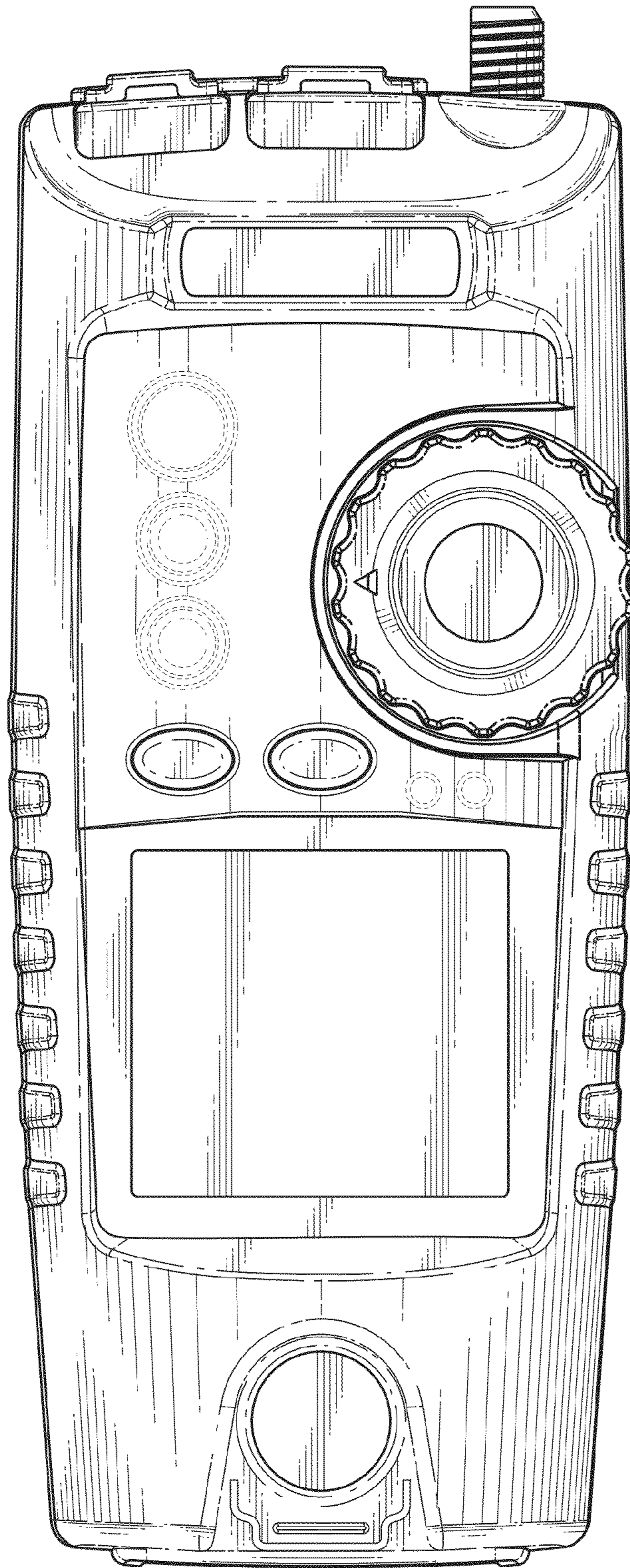
*Primary Examiner* — Antoine D Davis

**1 Claim, 10 Drawing Sheets**

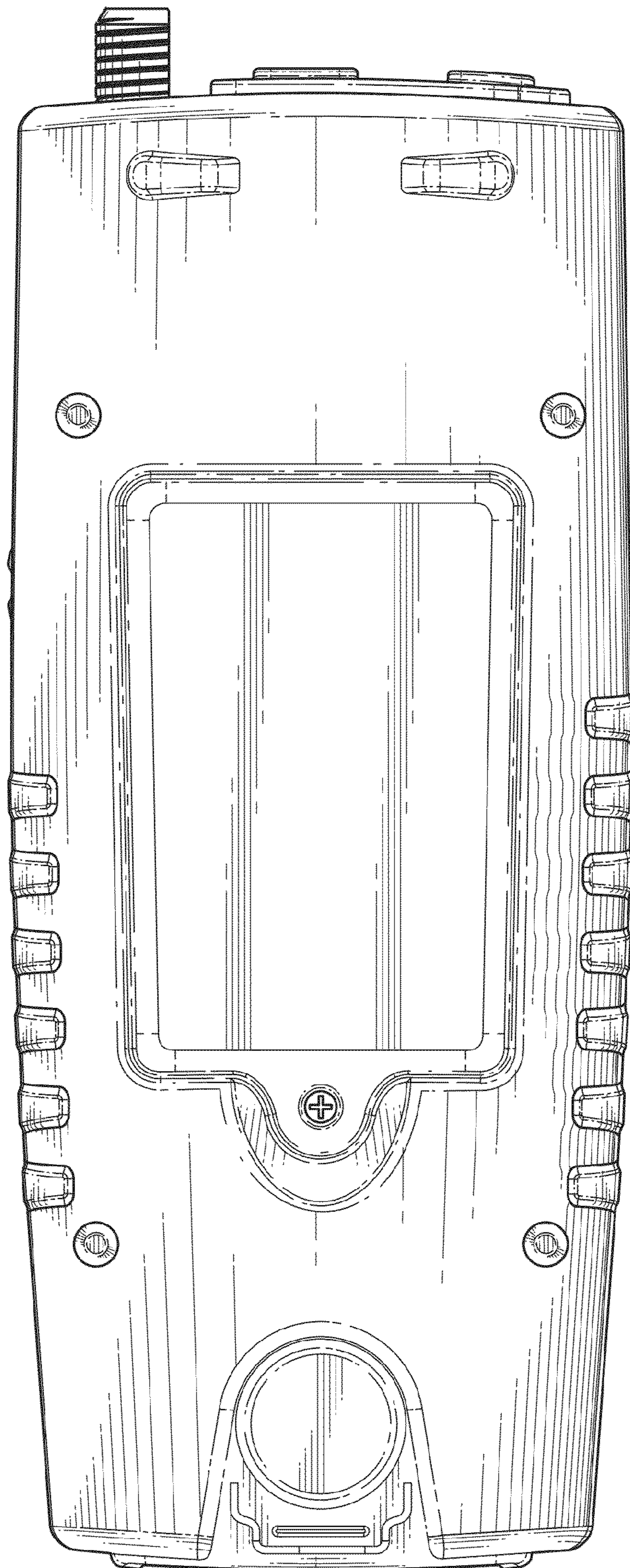




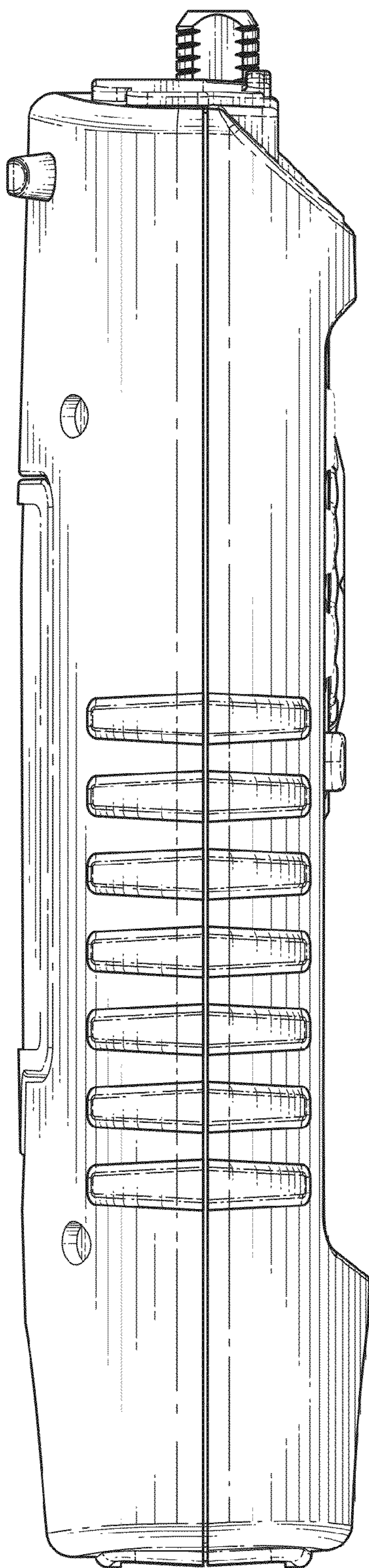
*Figure 1*



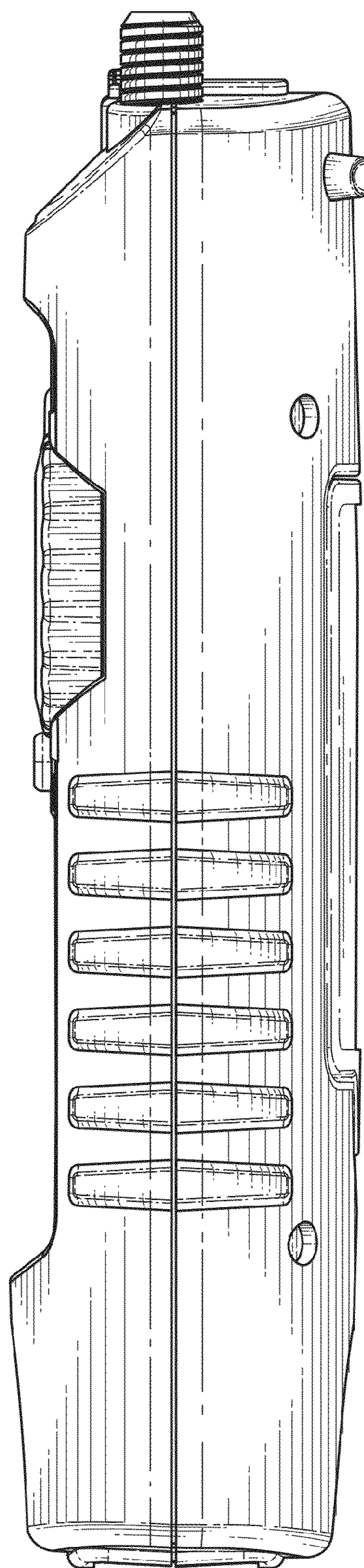
*Figure 2*



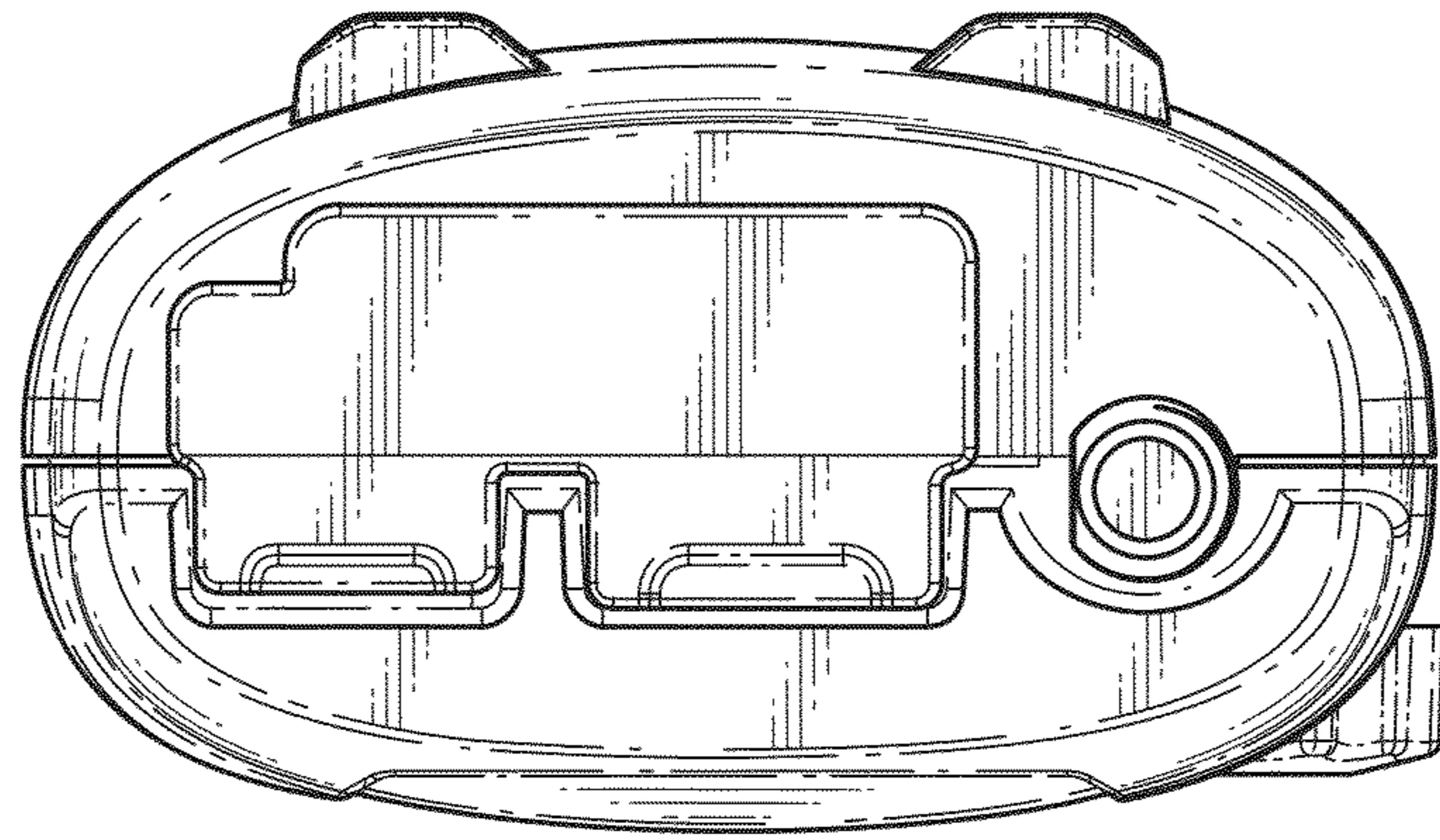
*Figure 3*



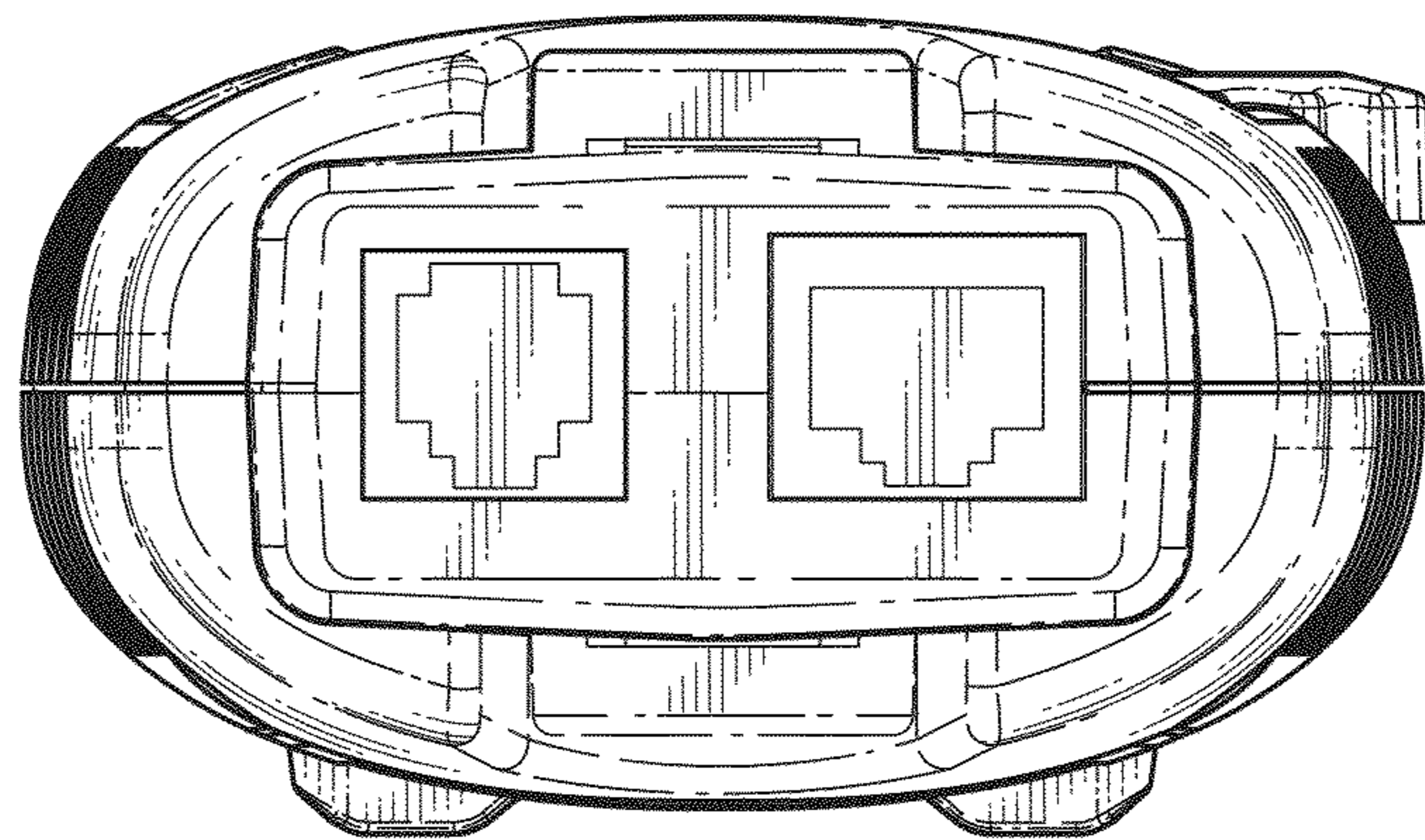
*Figure 4*



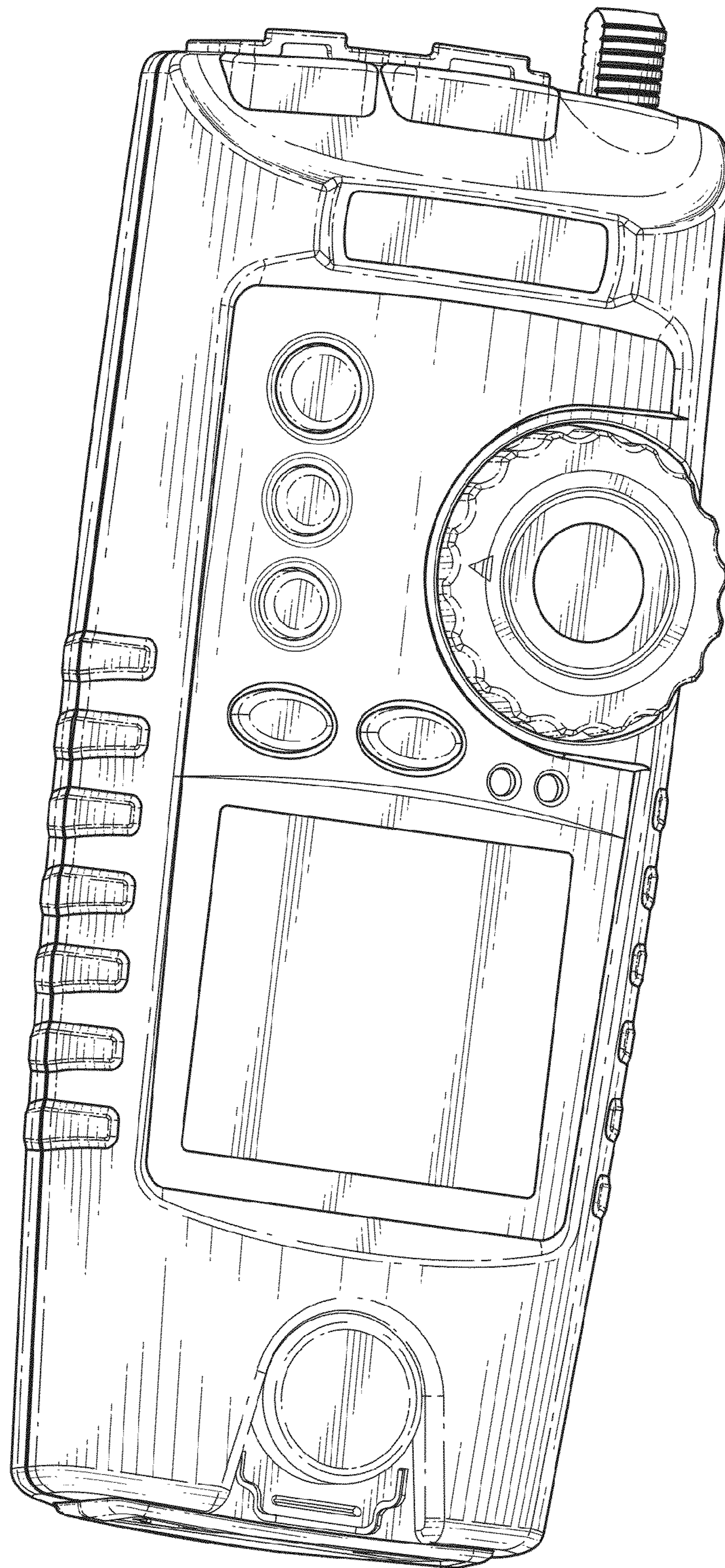
*Figure 5*



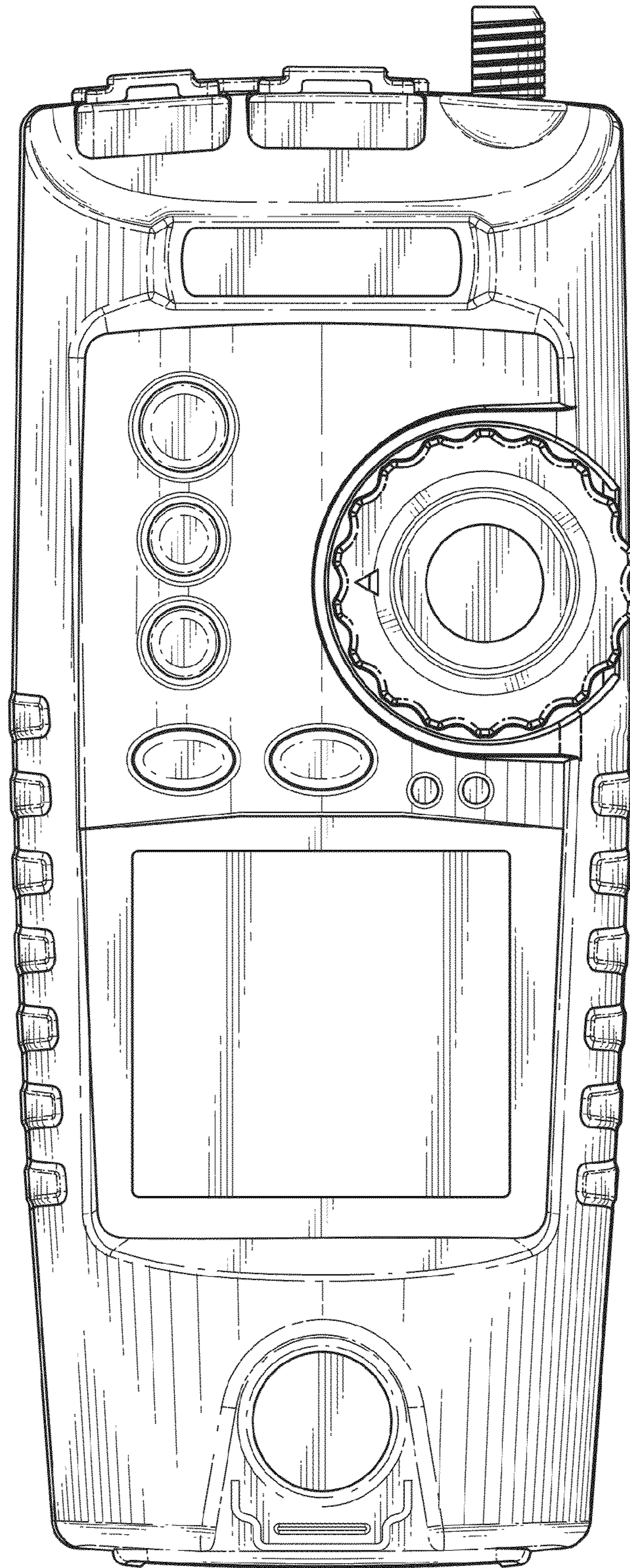
*Figure 6*



*Figure 7*

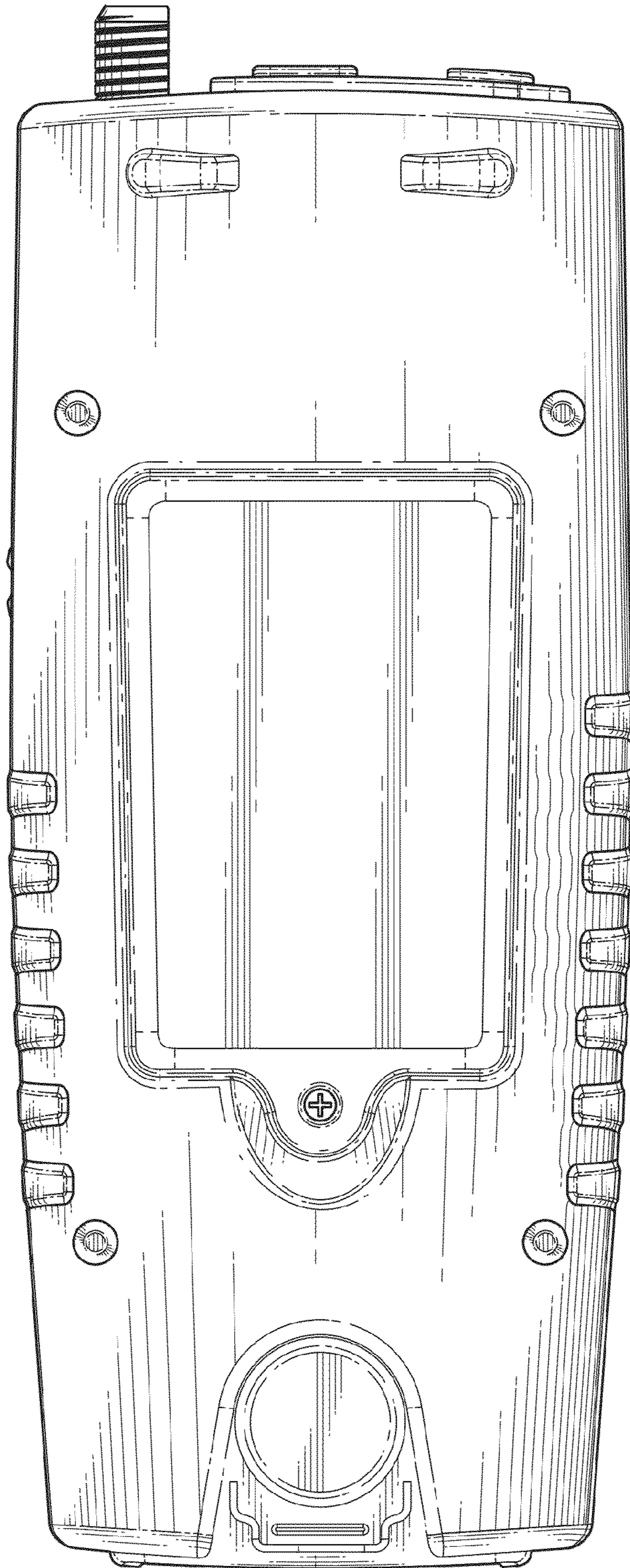


*Figure 8*

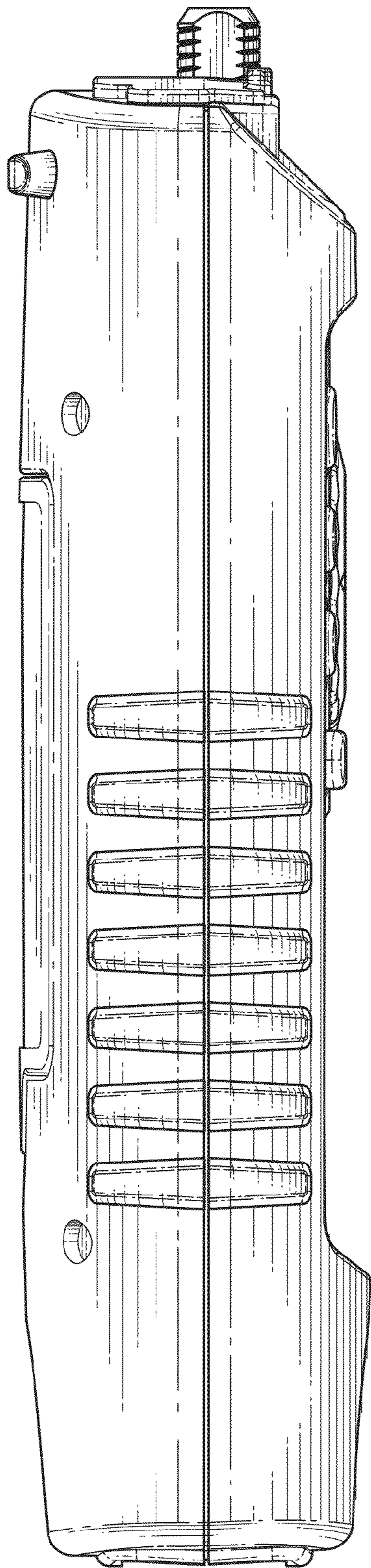


*Figure 9*

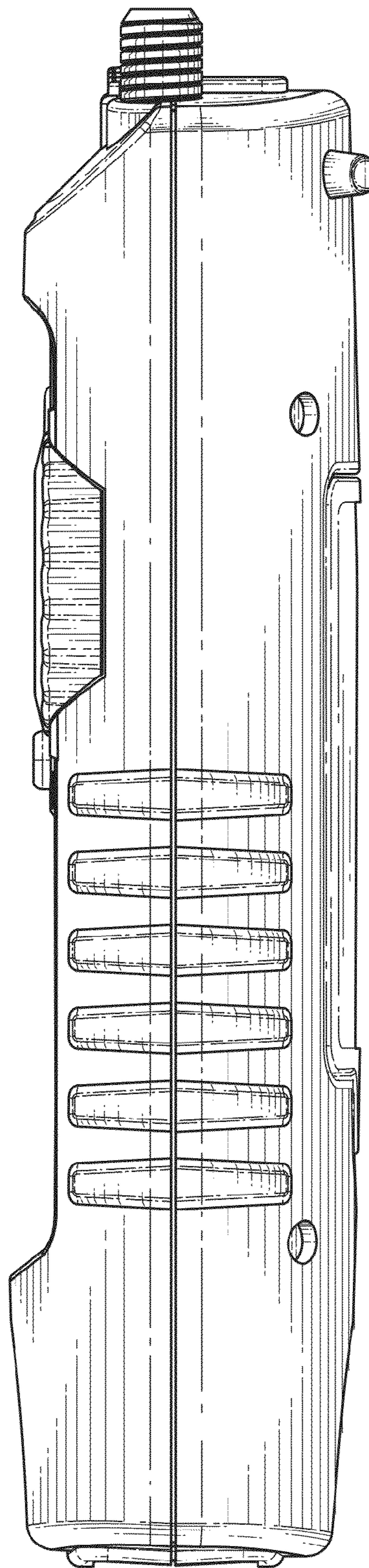




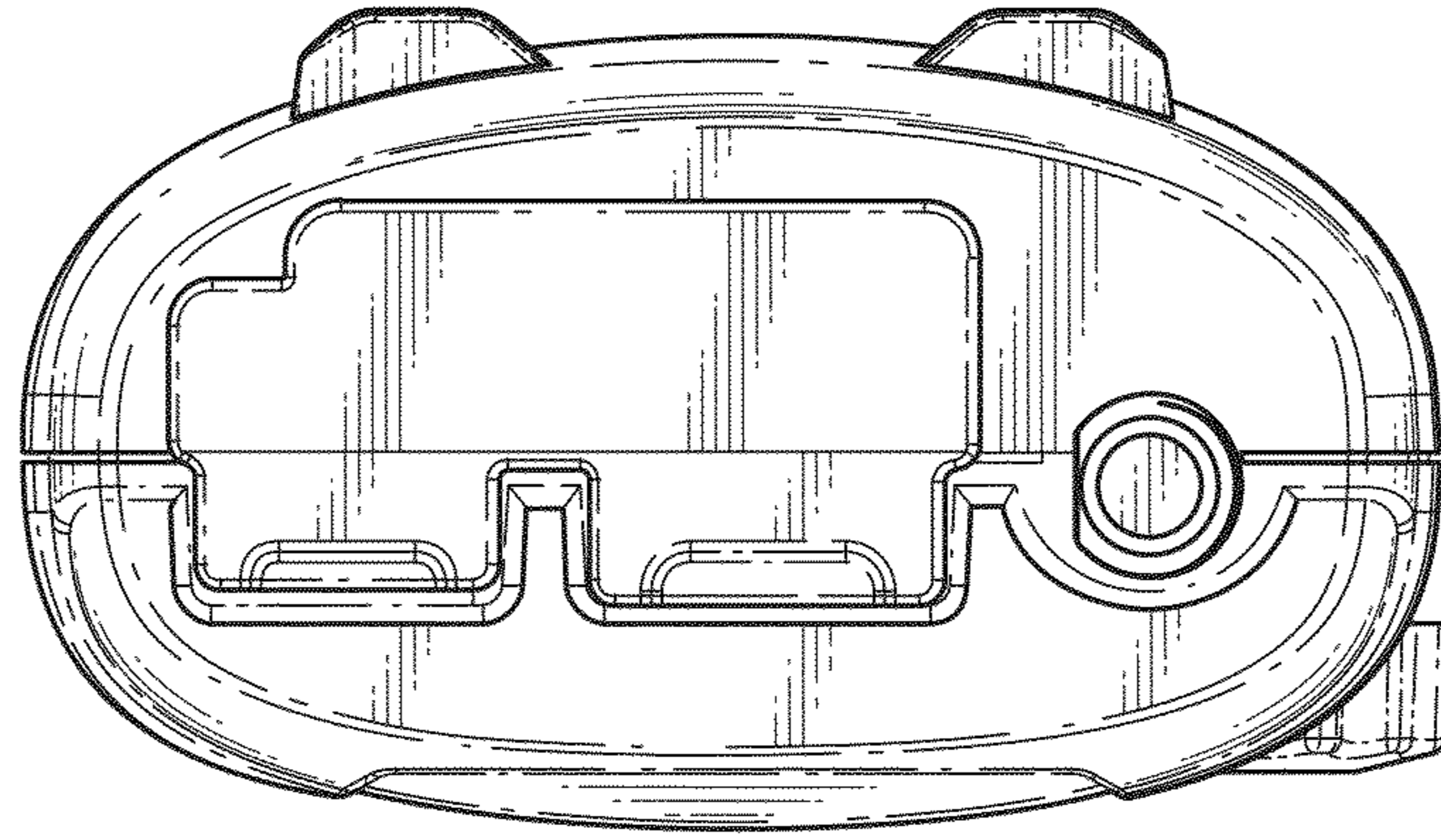
*Figure 10*



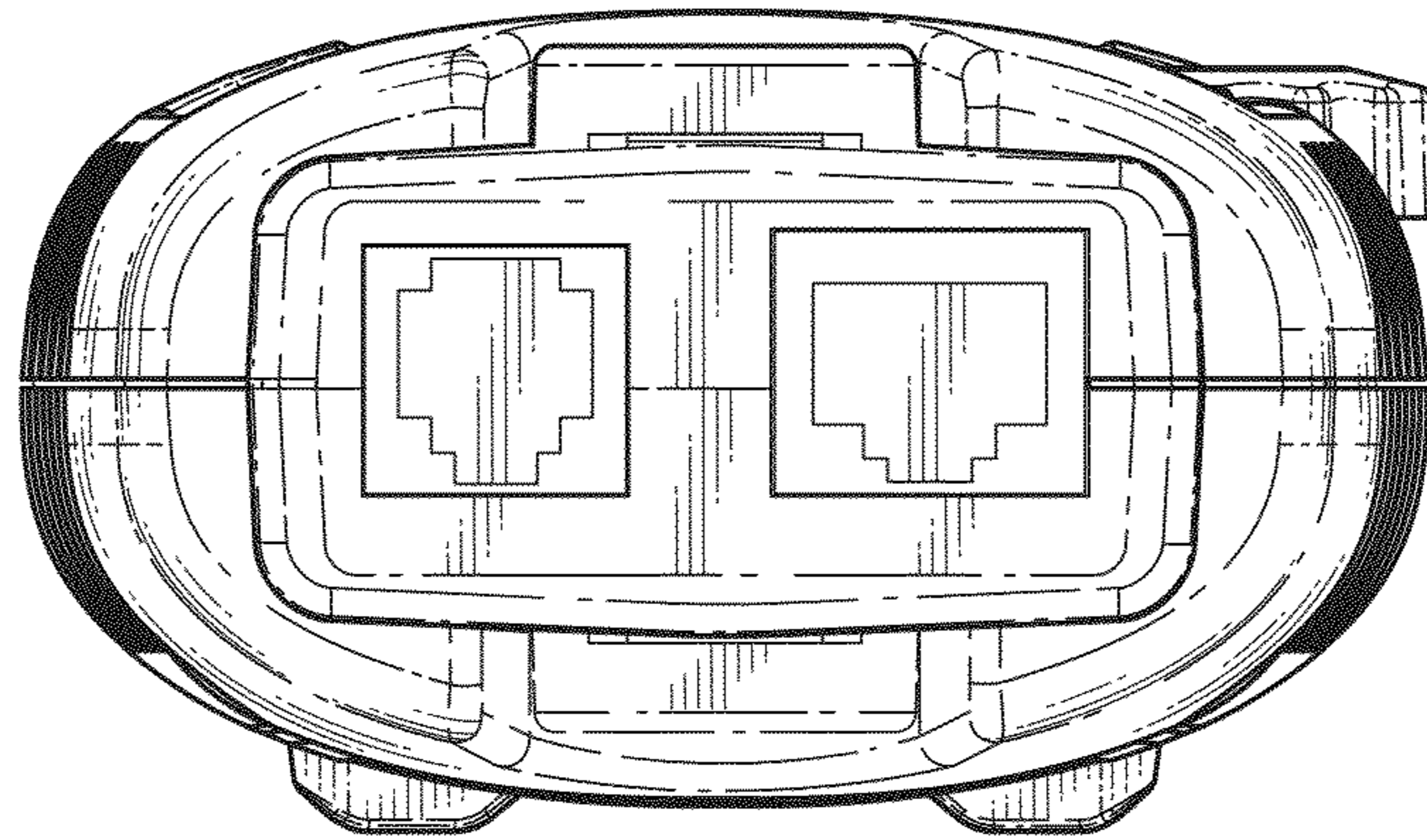
*Figure 11*



*Figure 12*



*Figure 13*



*Figure 14*