



US00D738228S

(12) **United States Design Patent**
Joshi

(10) **Patent No.:** **US D738,228 S**
(45) **Date of Patent:** **** Sep. 8, 2015**

(54) **SET OF NESTED MEASURING CUPS**

(71) Applicant: **Leela Ivie Joshi**, Brooklyn, NY (US)

(72) Inventor: **Leela Ivie Joshi**, Brooklyn, NY (US)

(**) Term: **14 Years**

(21) Appl. No.: **29/459,100**

(22) Filed: **Jun. 26, 2013**

(51) **LOC (10) Cl.** **10-04**

(52) **U.S. Cl.**
USPC **D10/46.3**

(58) **Field of Classification Search**

USPC D10/46.3, 46, 46.1, 46.2, 61, 96, 101,
D10/103, 81; D7/691, 692, 643, 647, 653,
D7/587, 590, 600.1, 533, 505, 543, 545,
D7/601, 300, 637-638, 688, 693, 368, 213,
D7/536, 500, 316, 318; 73/426-429, 1.73,
73/290 R, 291; 294/176, 178, 179, 180;
206/519, 520; 30/324-328; 222/548,
222/143, 553, 465, 466, 467, 499, 501,
222/23.83; D24/116

CPC ... G01F 19/002; G01F 19/00; B65D 33/1616;
B65D 77/245; B65D 21/00; A47G 19/00;
A61J 7/00; A61J 7/0023; B29C 45/16; B29C
2045/1659; B29K 2995/0018; A01B 1/02

See application file for complete search history.

(56) **References Cited**

U.S. PATENT DOCUMENTS

- D141,881 S * 7/1945 Mathewson D10/46.3
- 3,001,404 A * 9/1961 McDonnell, Jr. et al. 73/426
- 3,808,892 A * 5/1974 Litton 73/427
- 4,043,203 A 8/1977 Montesi
- D247,412 S * 3/1978 Montesi D10/46.3
- D259,460 S * 6/1981 Daenen et al. D10/46.3
- D294,214 S * 2/1988 Smith D10/46.2
- D297,202 S * 8/1988 Zumwalt D7/691
- D319,985 S * 9/1991 Crawford et al. D10/46.2
- D330,863 S 11/1992 Green
- D330,997 S * 11/1992 Spahni et al. D7/691
- D331,023 S * 11/1992 Mulry et al. D10/46.2
- D338,599 S * 8/1993 Zogg et al. D7/691

- D339,991 S * 10/1993 Mulry et al. D10/46.2
- 5,347,865 A * 9/1994 Mulry et al. 73/427
- D352,869 S * 11/1994 Lathrop D7/691
- D355,735 S * 2/1995 Shaffer et al. D32/53
- D361,532 S * 8/1995 North et al. D10/46.3
- D403,211 S * 12/1998 Weterrings D7/691
- D417,629 S * 12/1999 Weterrings D10/46.2
- D440,164 S 4/2001 Kerr
- D450,605 S * 11/2001 Wright D10/46.3
- D473,752 S * 4/2003 Kerr D7/505
- D519,333 S 4/2006 Stewart
- D567,600 S * 4/2008 Matsumura et al. D7/691
- D582,798 S * 12/2008 Mantilla et al. D10/46.3
- D589,379 S * 3/2009 Zerlin D10/46.2
- 7,753,206 B2 7/2010 Sawhney et al.
- D624,444 S * 9/2010 Fenner D10/46.2
- D624,836 S * 10/2010 Blust et al. D10/46.3
- 2010/0326848 A1 * 12/2010 Mangin et al. 206/216

FOREIGN PATENT DOCUMENTS

EP 1990614 A2 11/2008

OTHER PUBLICATIONS

<http://www.shopxylem.com/shop/kitchen-tools/nesting-measuring-cups>, printed from the web on Jun. 3, 2013.

* cited by examiner

Primary Examiner — Ian Simmons

Assistant Examiner — Shannon Morgan

(74) *Attorney, Agent, or Firm* — Lippincott IP, LLC

(57) **CLAIM**

The ornamental design for a set of nested measuring cups, as shown and described.

DESCRIPTION

FIG. 1 is a perspective view of a set of nested measuring cups showing my new design;
FIG. 2 is a front elevational view thereof;
FIG. 3 is a rear elevational view thereof;
FIG. 4 is a left-side elevational view thereof;
FIG. 5 is a right-side elevational view thereof;
FIG. 6 is a top plan view thereof;
FIG. 7 is a bottom plan view thereof;

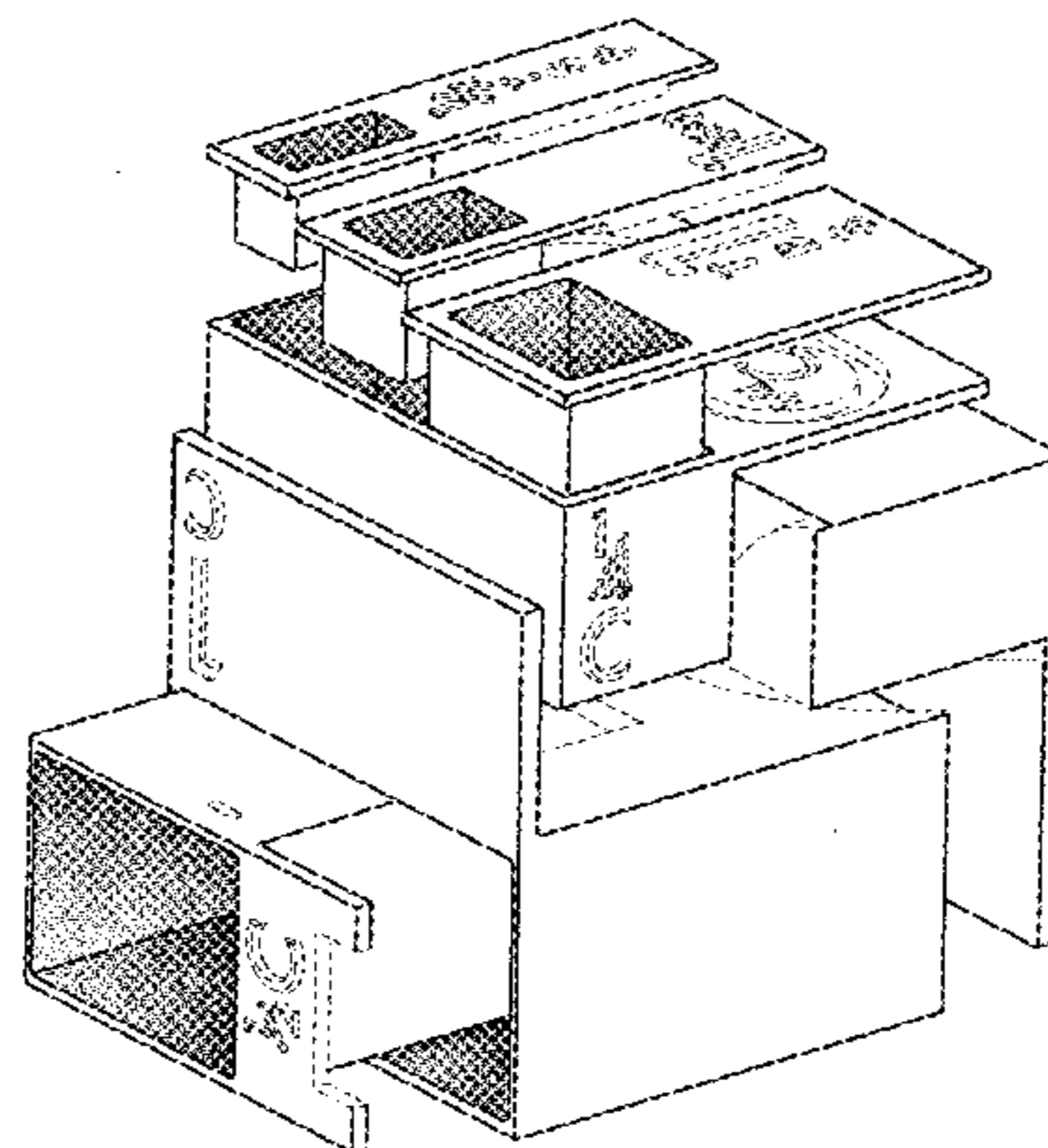
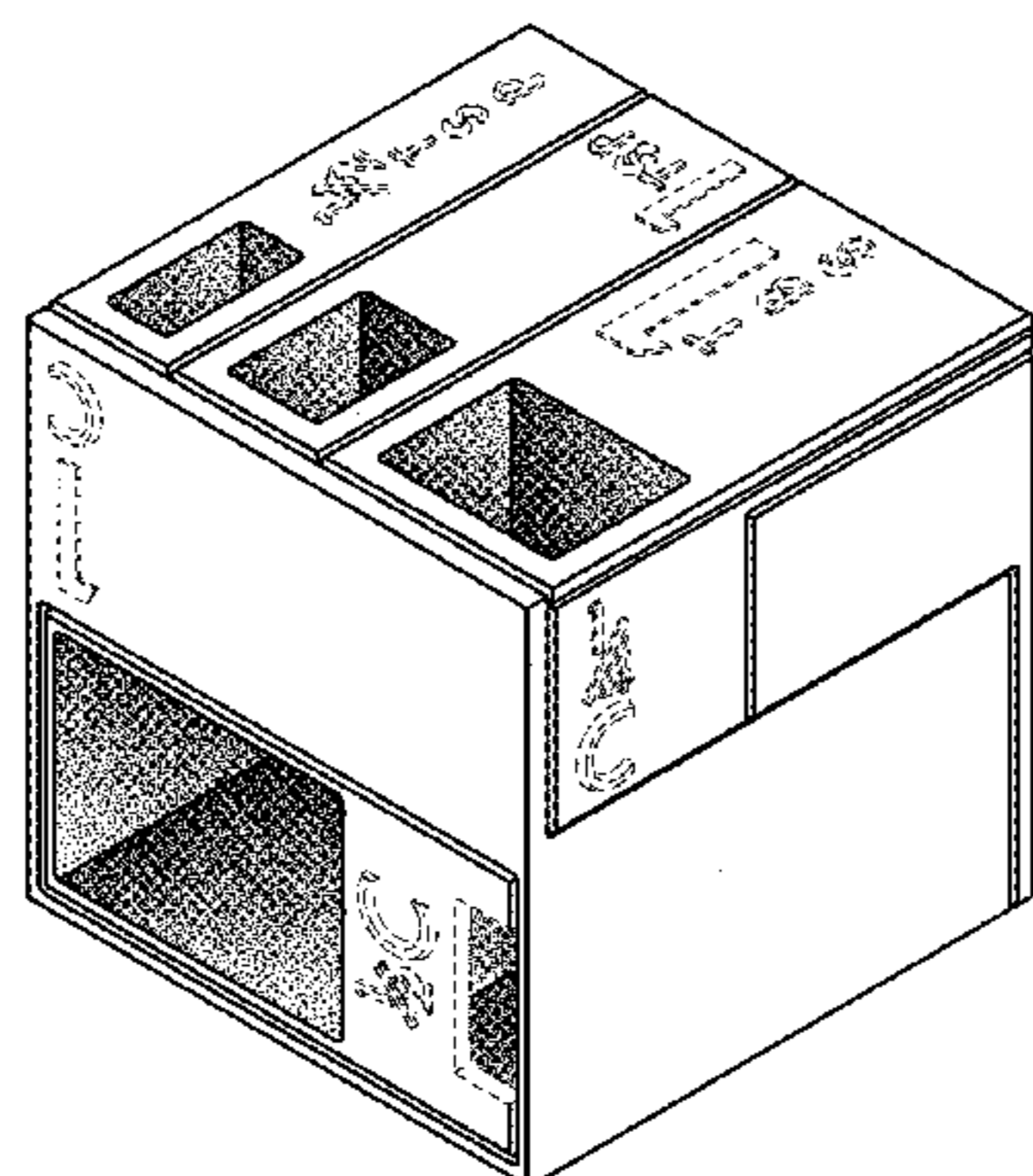

FIG. 8 is an exploded perspective view of the set of nested measuring cups shown in FIG. 1;
 FIG. 9 is a perspective view of a first measuring cup of the set of nested measuring cups of FIG. 1, shown with the other measuring cups removed for ease of illustration;
 FIG. 10 is a front elevational view thereof;
 FIG. 11 is a rear elevational view thereof;
 FIG. 12 is a left-side elevational view thereof;
 FIG. 13 is a right-side elevational view thereof;
 FIG. 14 is a top plan view thereof;
 FIG. 15 is a bottom plan view thereof;
 FIG. 16 is a perspective view of a second measuring cup of the set of nested measuring cups of FIG. 1, shown with the other measuring cups removed for ease of illustration;
 FIG. 17 is a front elevational view thereof;
 FIG. 18 is a rear elevational view thereof;
 FIG. 19 is a left-side elevational view thereof;
 FIG. 20 is a right-side elevational view thereof;
 FIG. 21 is a top plan view thereof;
 FIG. 22 is a bottom plan view thereof;
 FIG. 23 is a perspective view of a third measuring cup of the set of nested measuring cups of FIG. 1, shown with the other measuring cups removed for ease of illustration;
 FIG. 24 is a front elevational view thereof;
 FIG. 25 is a rear elevational view thereof;
 FIG. 26 is a left-side elevational view thereof;
 FIG. 27 is a right-side elevational view thereof;
 FIG. 28 is a top plan view thereof;
 FIG. 29 is a bottom plan view thereof;
 FIG. 30 is a perspective view of a fourth measuring cup of the set of nested measuring cups of FIG. 1, shown with the other measuring cups removed for ease of illustration;
 FIG. 31 is a front elevational view thereof;
 FIG. 32 is a rear elevational view thereof;
 FIG. 33 is a left-side elevational view thereof;
 FIG. 34 is a right-side elevational view thereof;
 FIG. 35 is a top plan view thereof;

FIG. 36 is a bottom plan view thereof;
 FIG. 37 is a perspective view of a fifth measuring cup of the set of nested measuring cups of FIG. 1, shown with the other measuring cups removed for ease of illustration;
 FIG. 38 is a front elevational view thereof;
 FIG. 39 is a rear elevational view thereof;
 FIG. 40 is a left-side elevational view thereof;
 FIG. 41 is a right-side elevational view thereof;
 FIG. 42 is a top plan view thereof;
 FIG. 43 is a bottom plan view thereof;
 FIG. 44 is a perspective view of a sixth measuring cup of the set of nested measuring cups of FIG. 1, shown with the other measuring cups removed for ease of illustration;
 FIG. 45 is a front elevational view thereof;
 FIG. 46 is a rear elevational view thereof;
 FIG. 47 is a left-side elevational view thereof;
 FIG. 48 is a right-side elevational view thereof;
 FIG. 49 is a top plan view thereof;
 FIG. 50 is a bottom plan view thereof;
 FIG. 51 is a perspective view of a seventh measuring cup of the set of nested measuring cups of FIG. 1, shown with the other measuring cups removed for ease of illustration;
 FIG. 52 is a front elevational view thereof;
 FIG. 53 is a rear elevational view thereof;
 FIG. 54 is a left-side elevational view thereof;
 FIG. 55 is a right-side elevational view thereof;
 FIG. 56 is a top plan view thereof; and,
 FIG. 57 is a bottom plan view thereof.
 The broken lines formed by short dashes showing the units of measurement and the locking mechanism in FIGS. 1-57 represent portions of the set of nested measuring cups that form no part of the claimed design. The broken lines formed by alternating short dashes and long dashes and faded portions within in FIGS. 2, 3, 6, 14, 21, 28, 35, 39, 45, and 52 represent boundaries of the set of nested measuring cups that form no part of the claimed design.

1 Claim, 57 Drawing Sheets

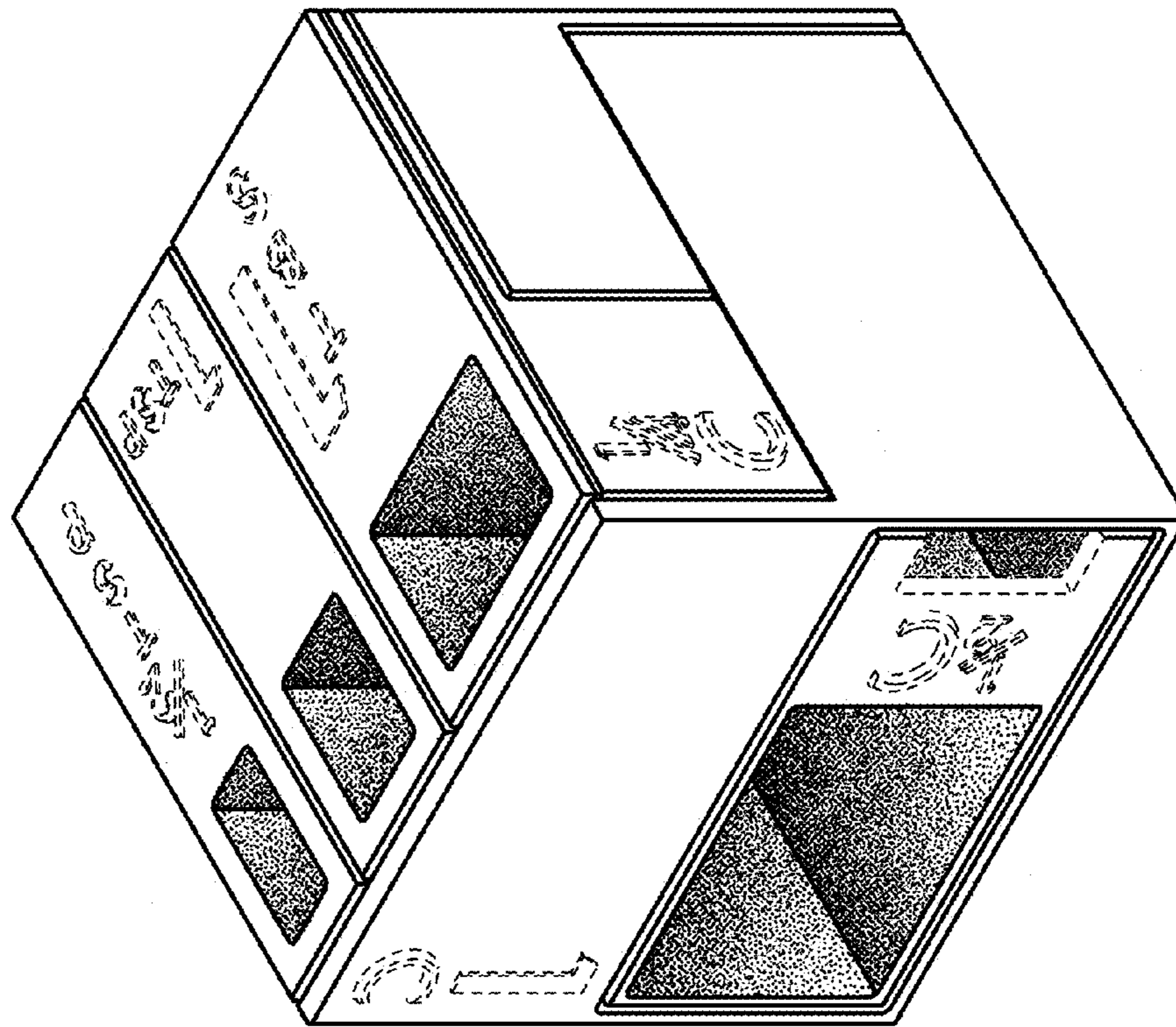

Fig. 1

Fig. 2

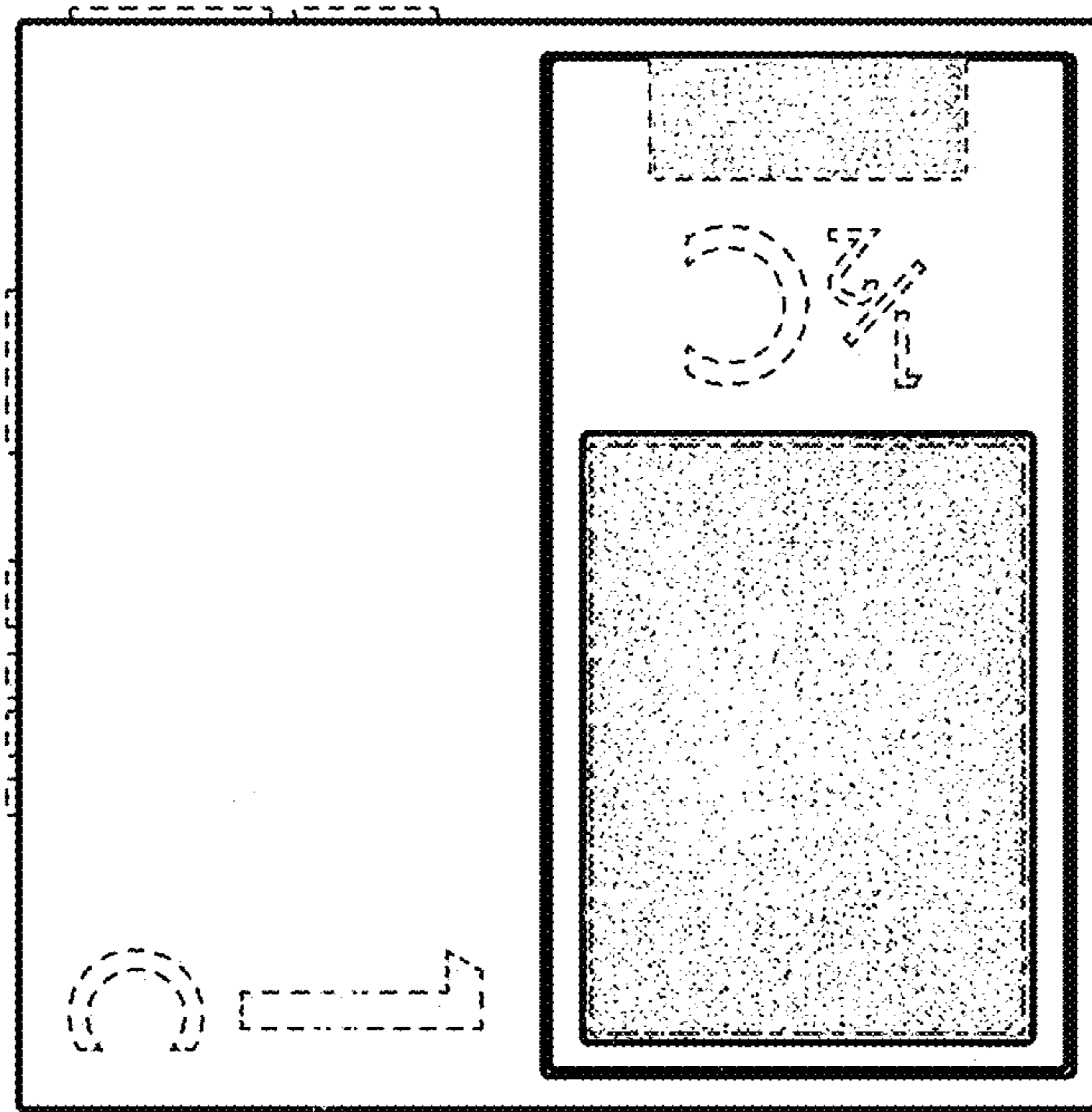
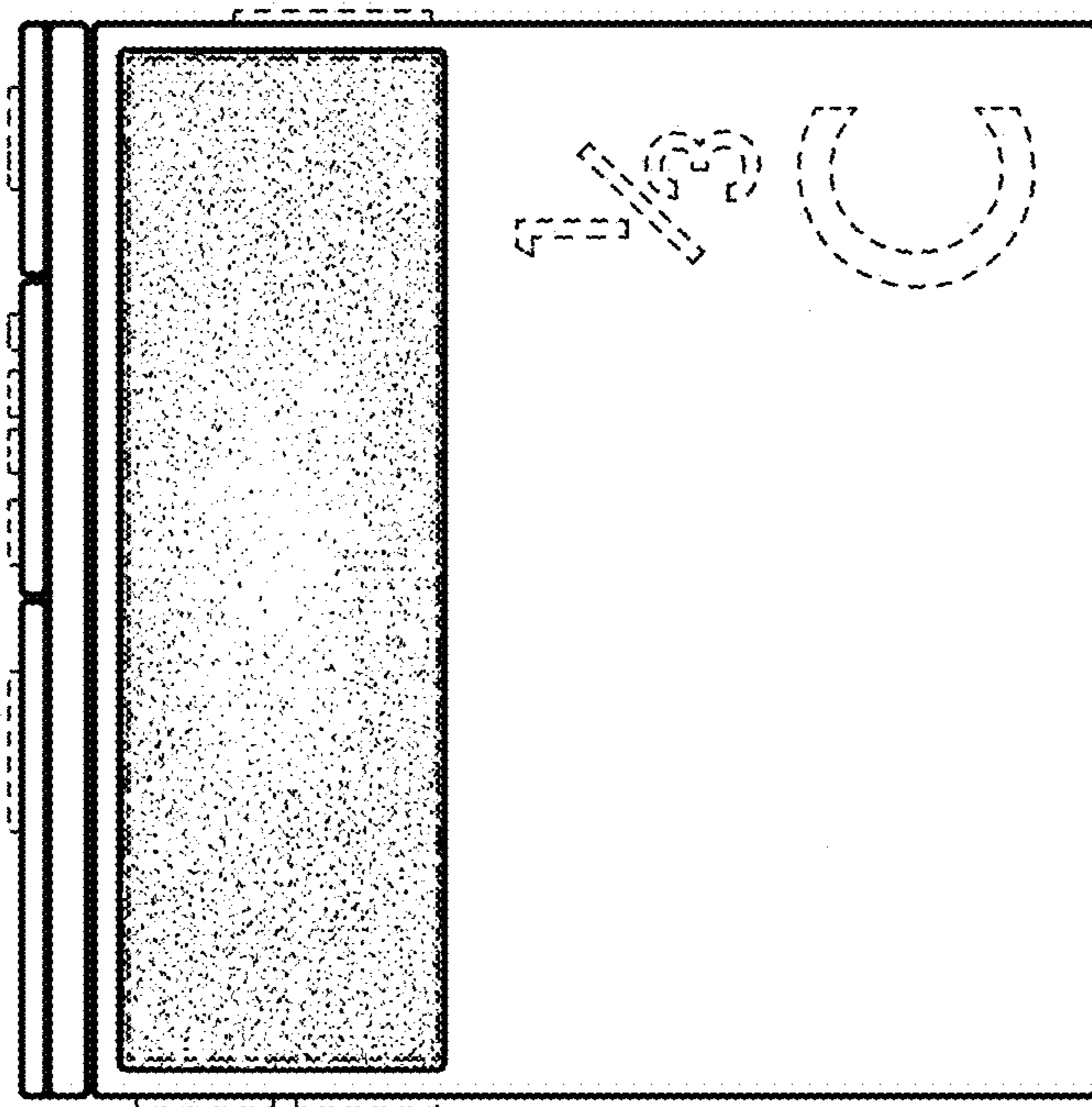

Fig. 3



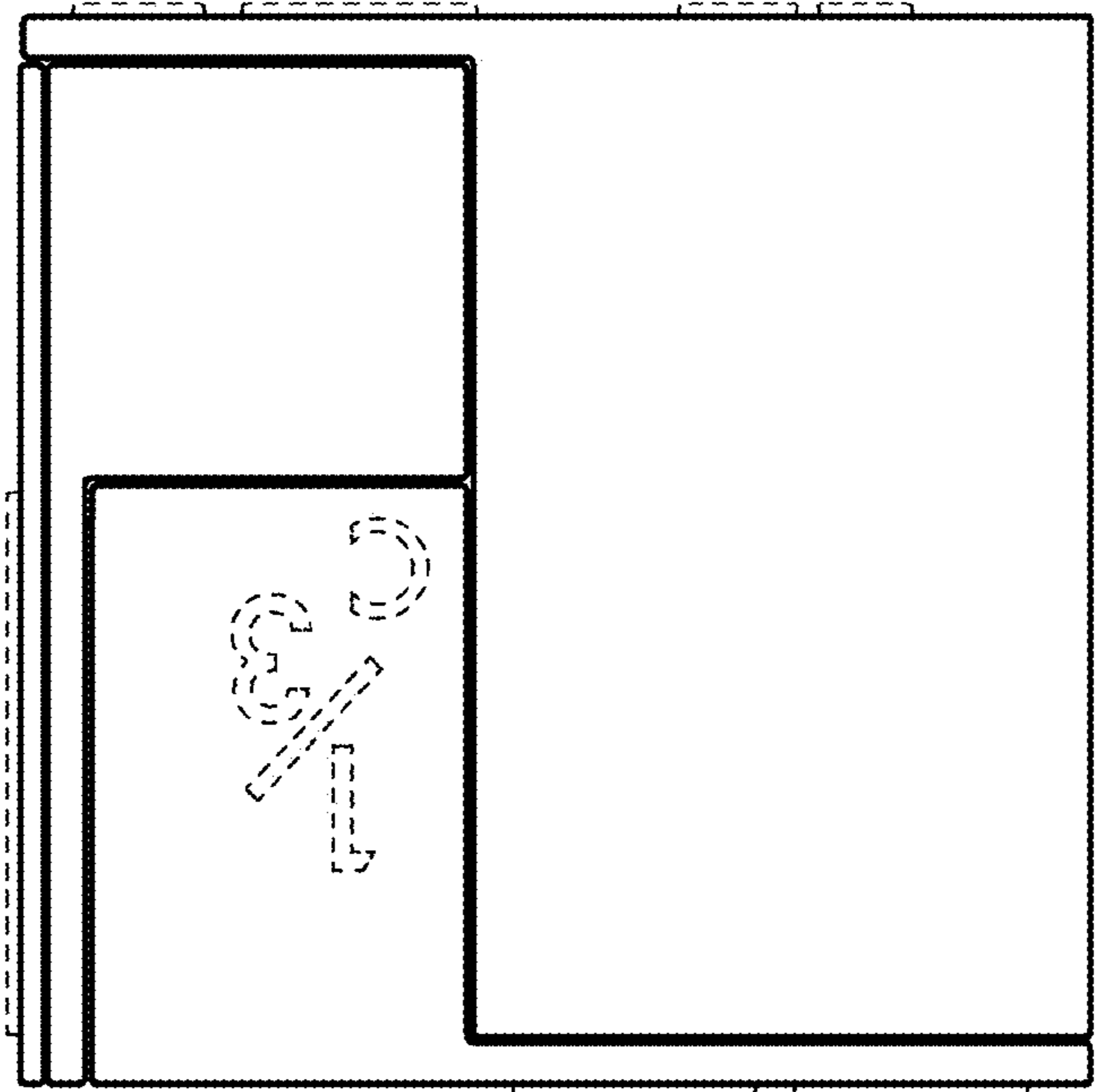

Fig. 4

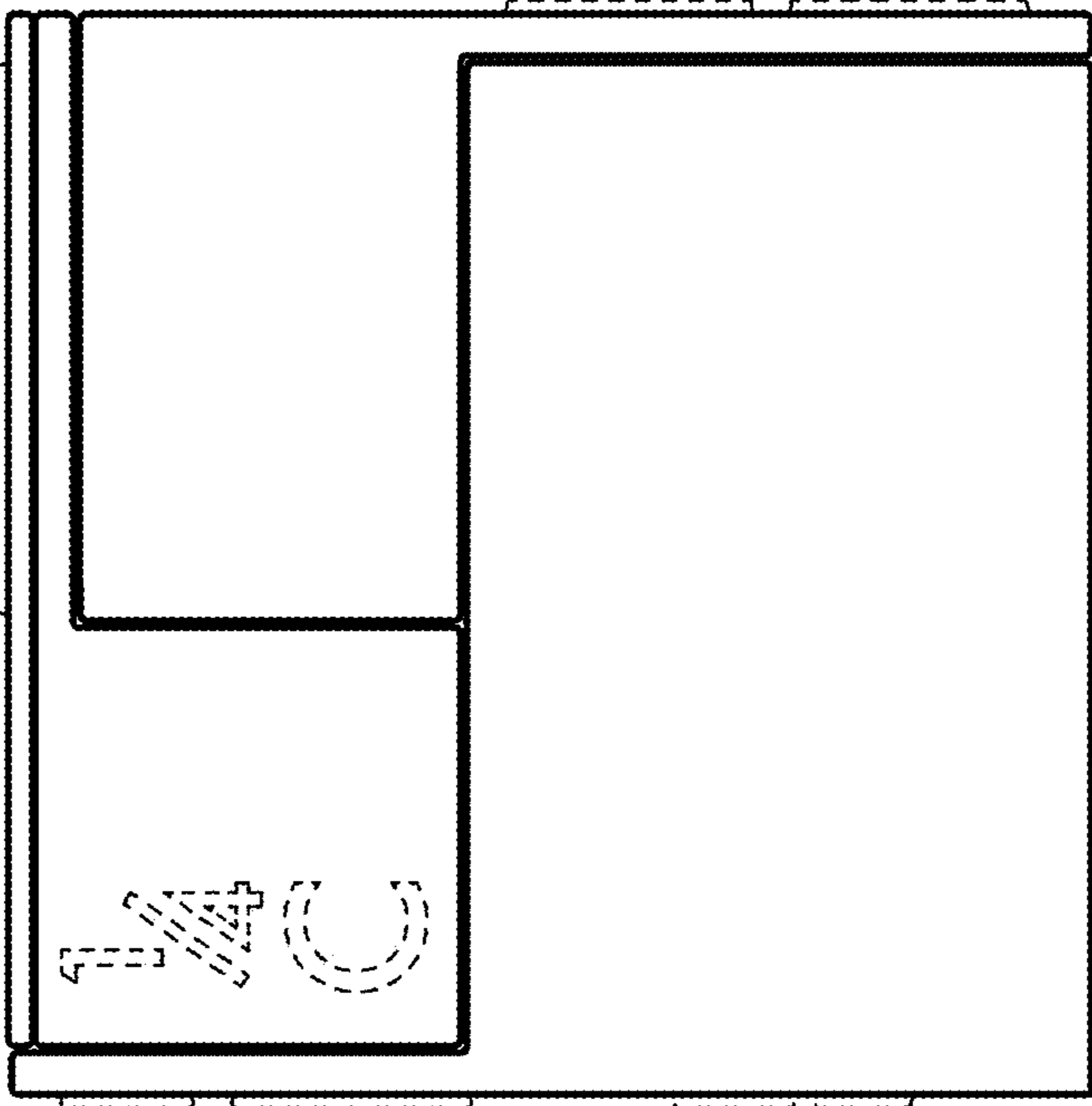
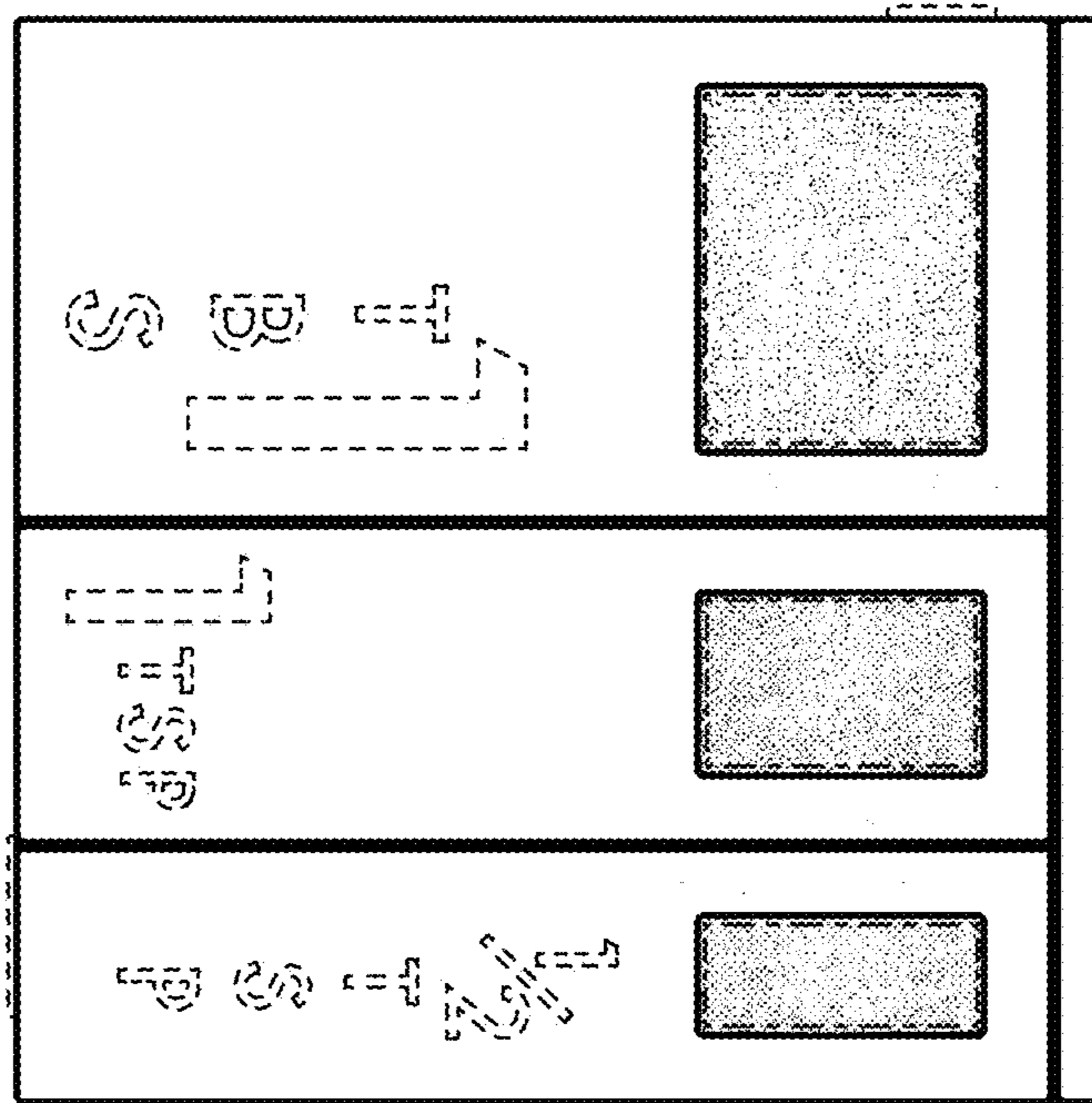

Fig. 5

Fig. 6



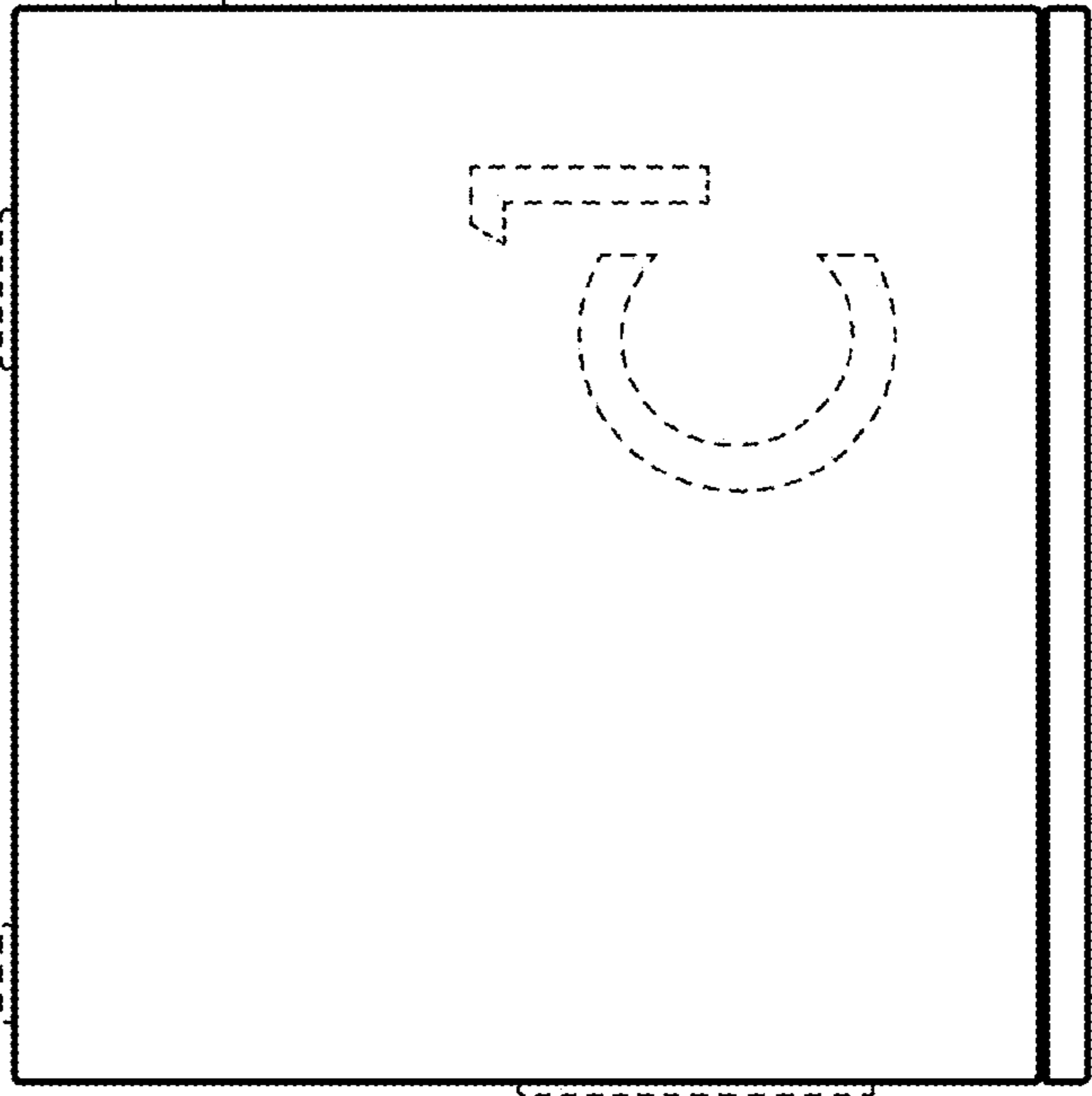
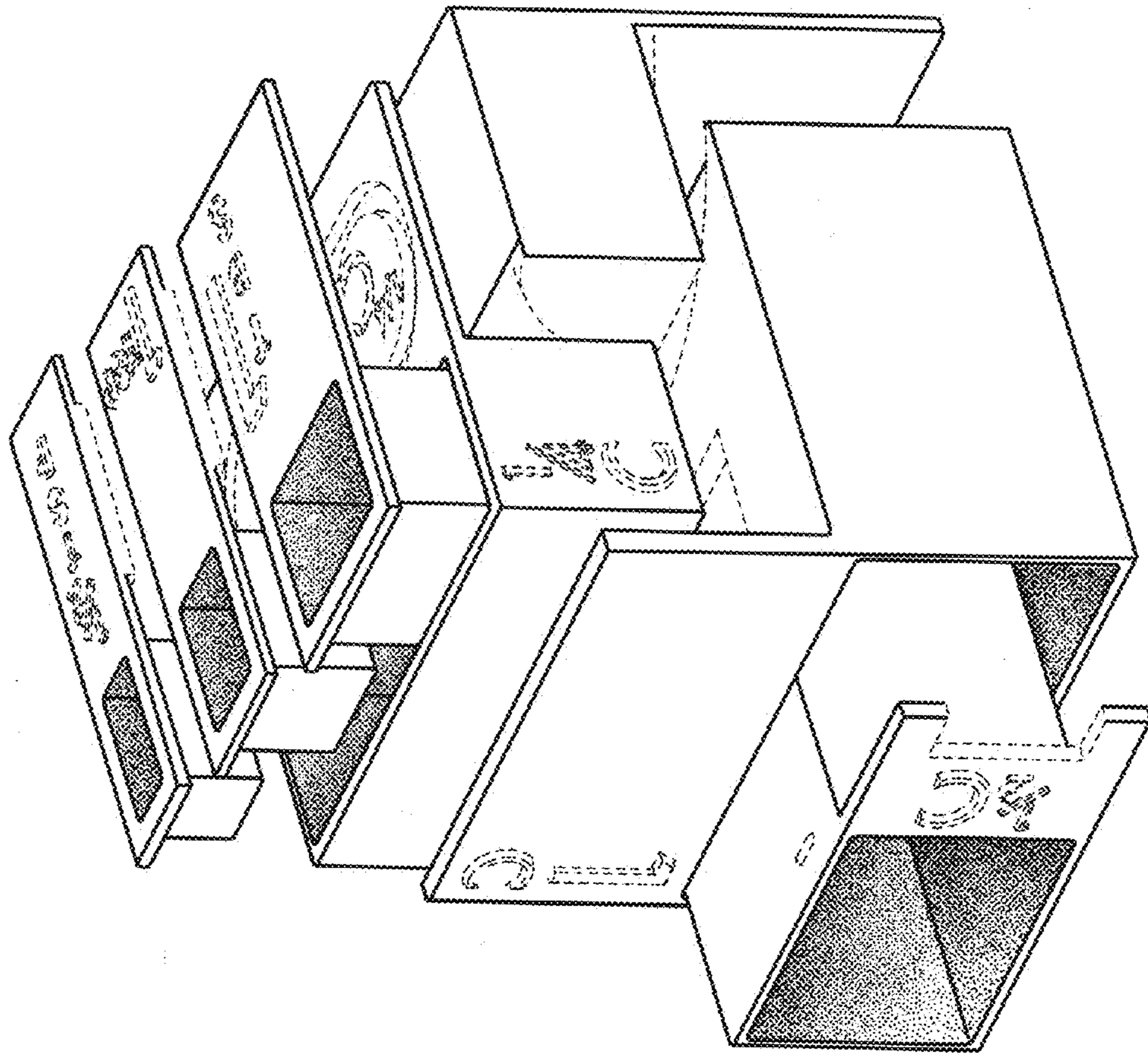

Fig. 7

Fig. 8



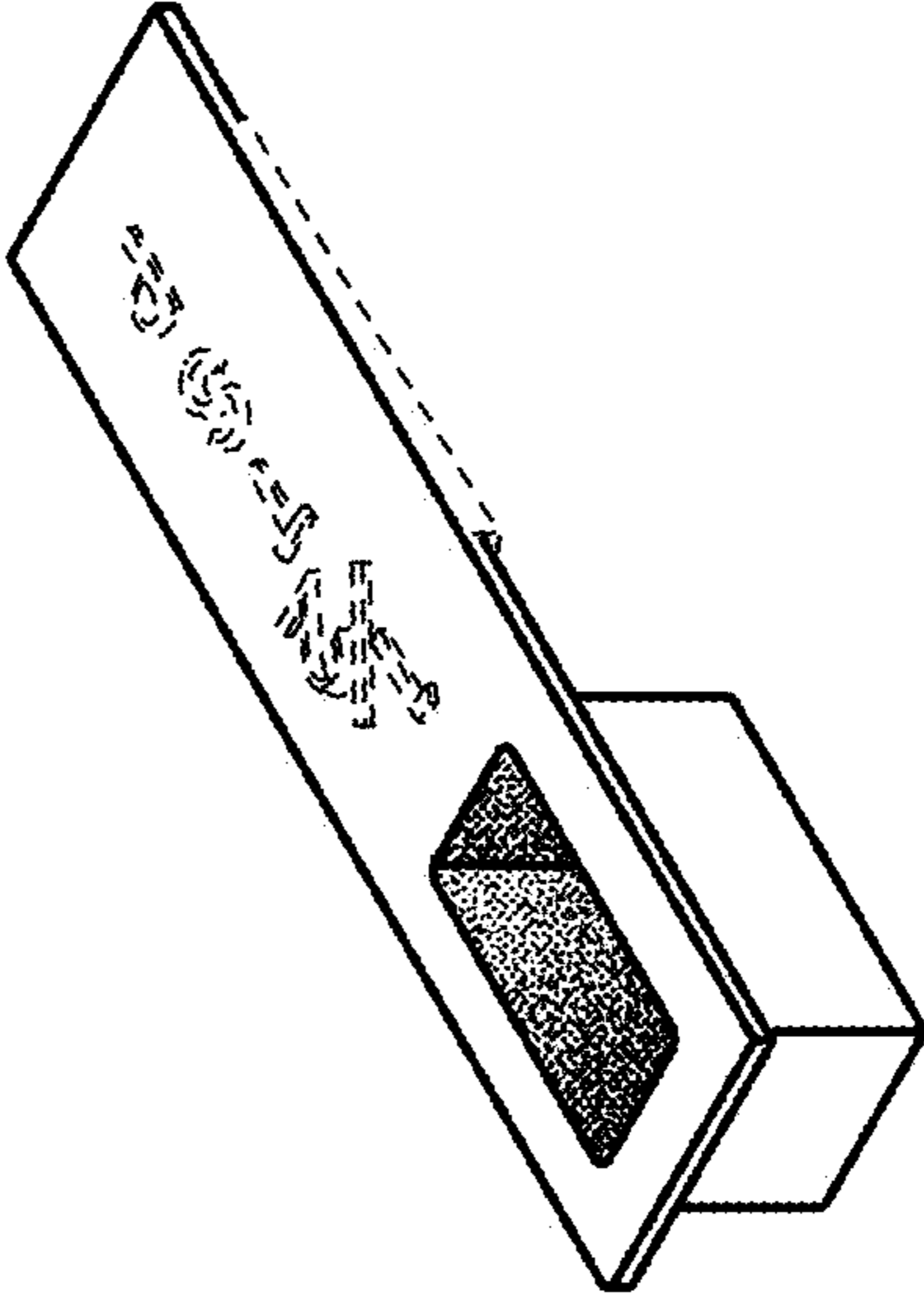

Fig. 9

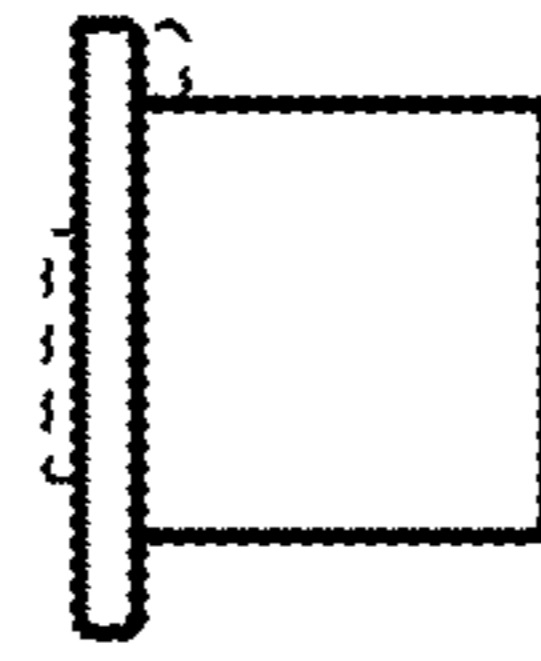

Fig. 10

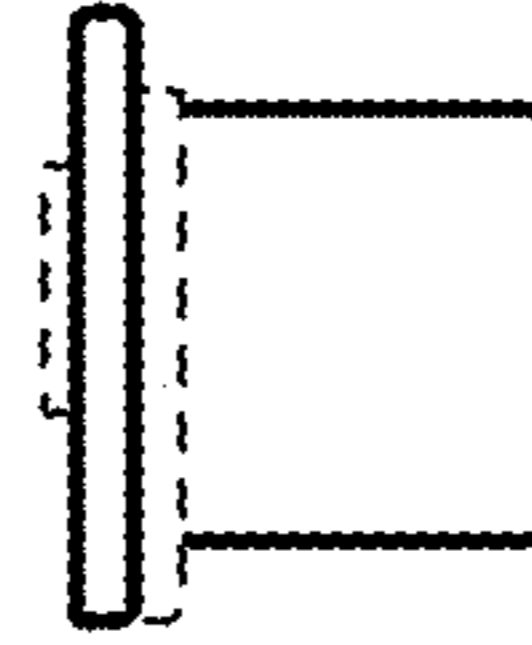

Fig. 11



Fig. 12



Fig. 13

Fig. 14

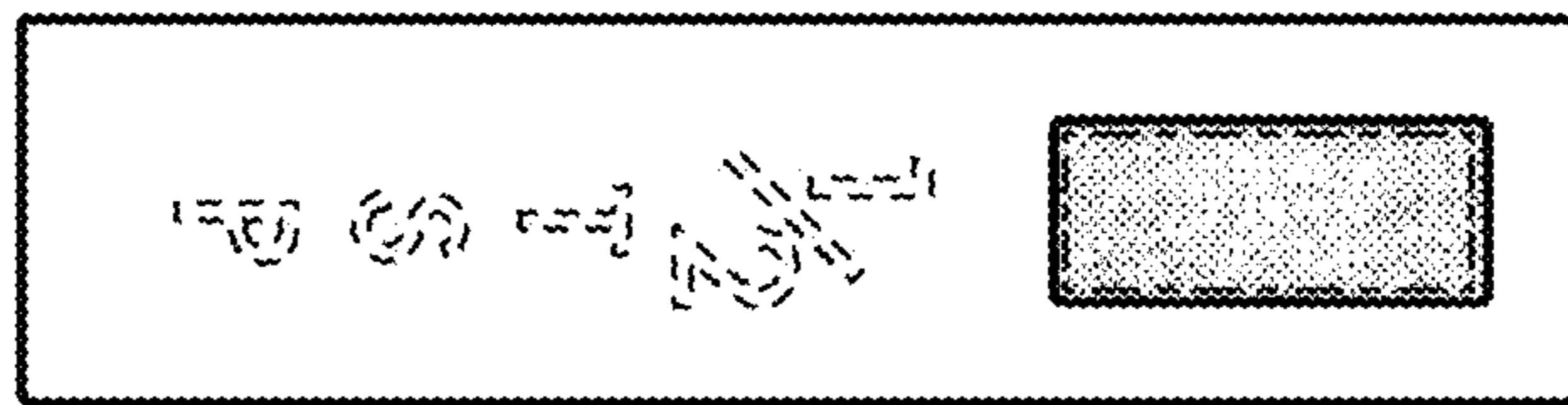



Fig. 15

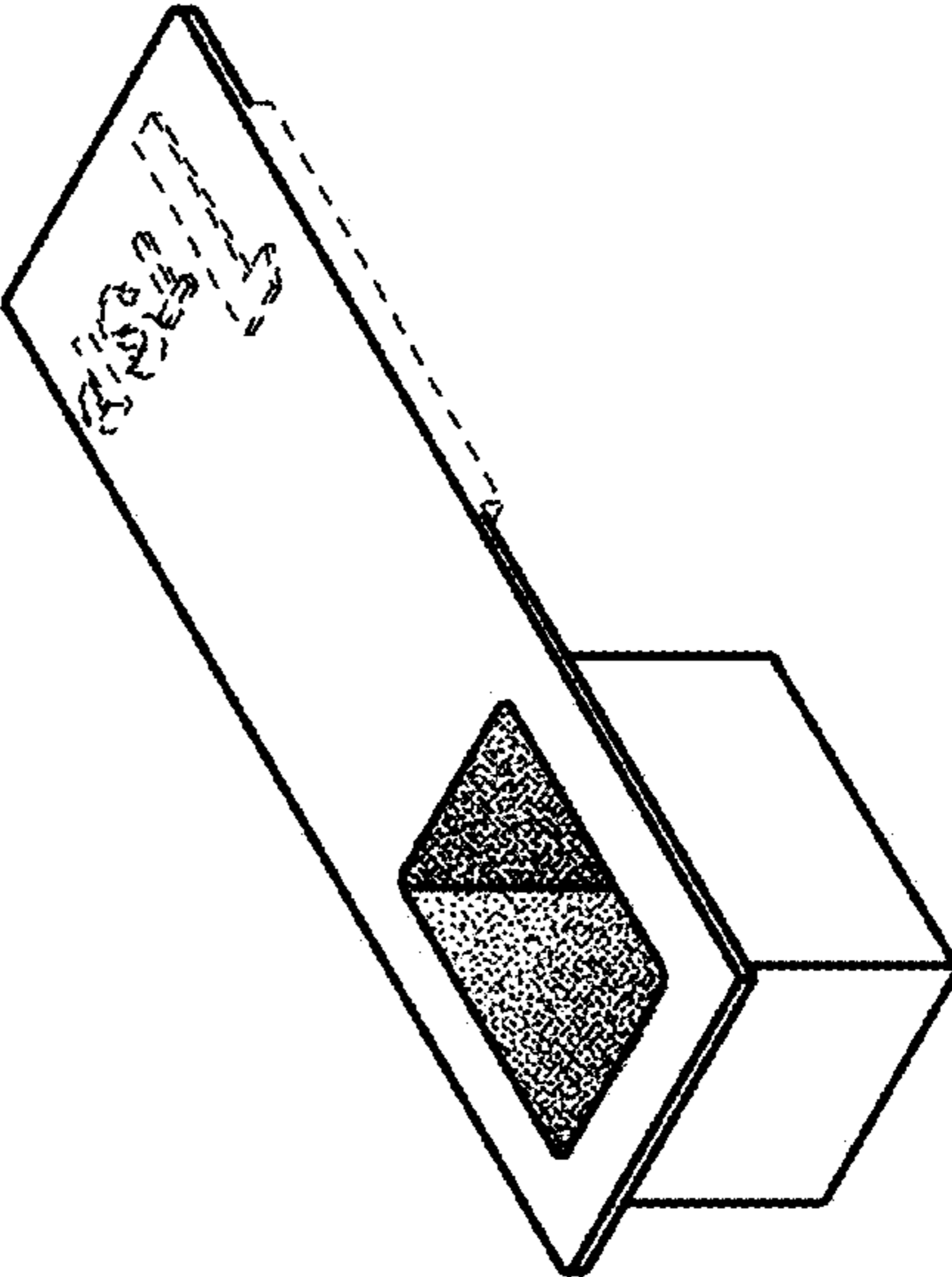

Fig. 16

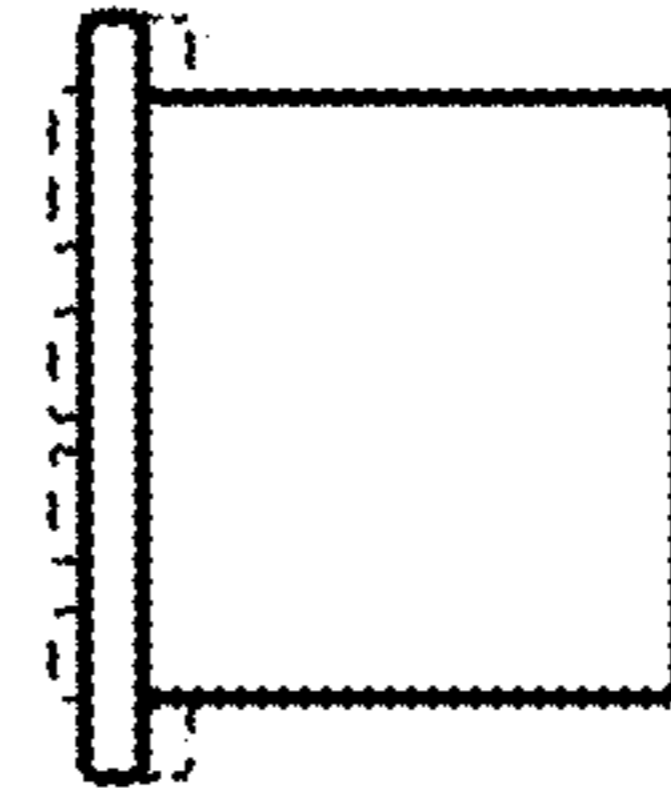

Fig. 17

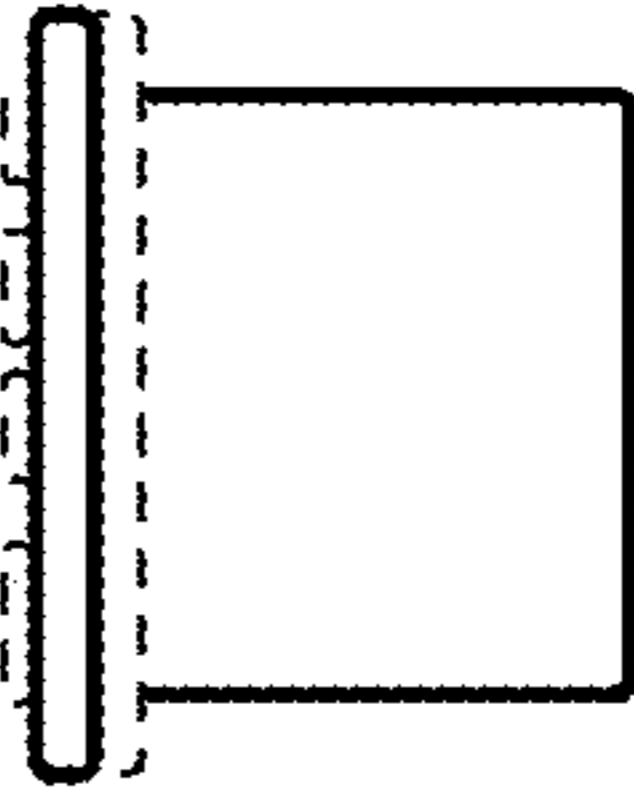

Fig. 18

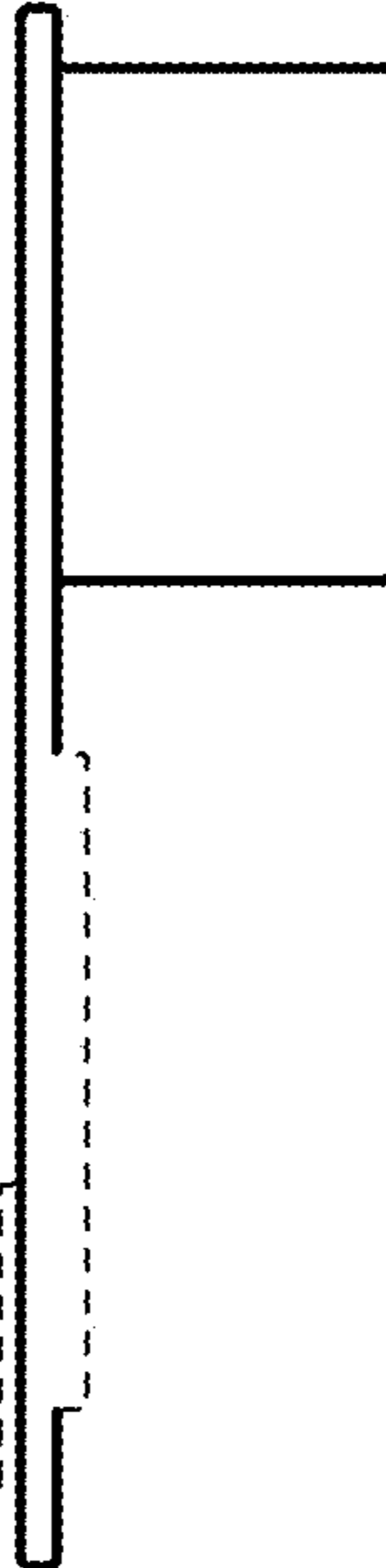

Fig. 19

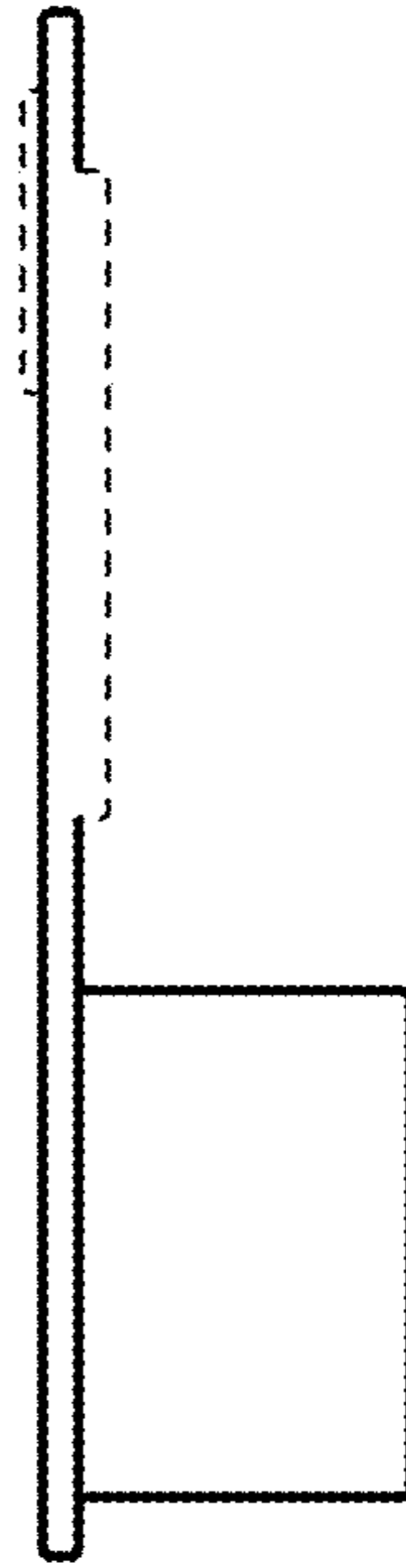

Fig. 20

Fig. 21



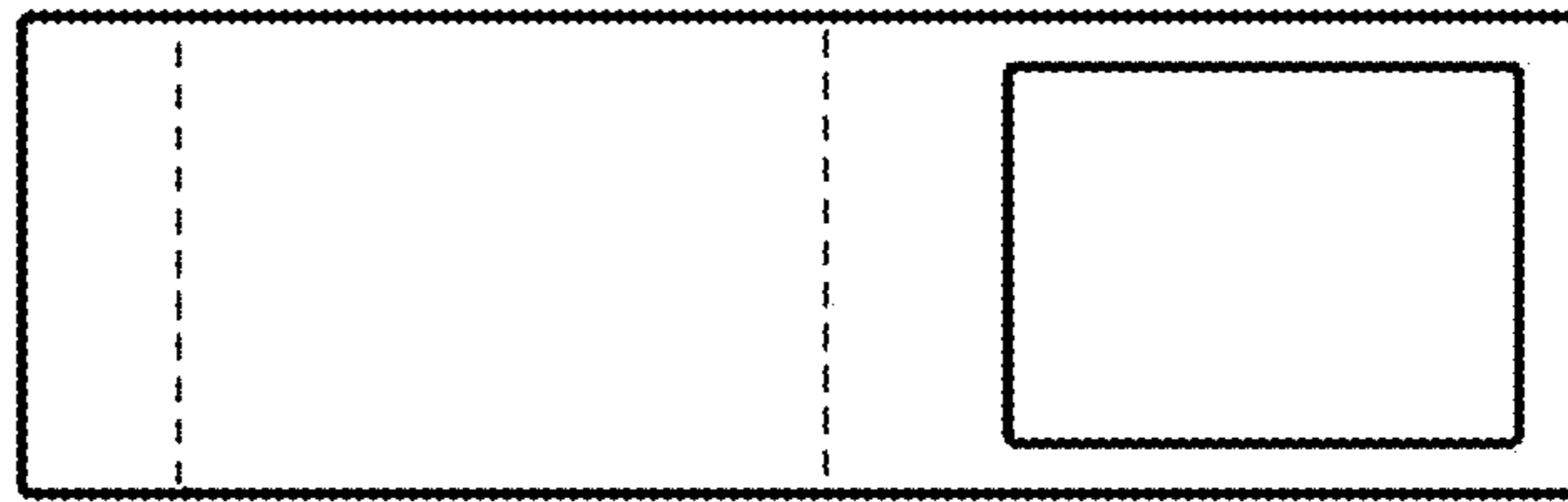

Fig. 22

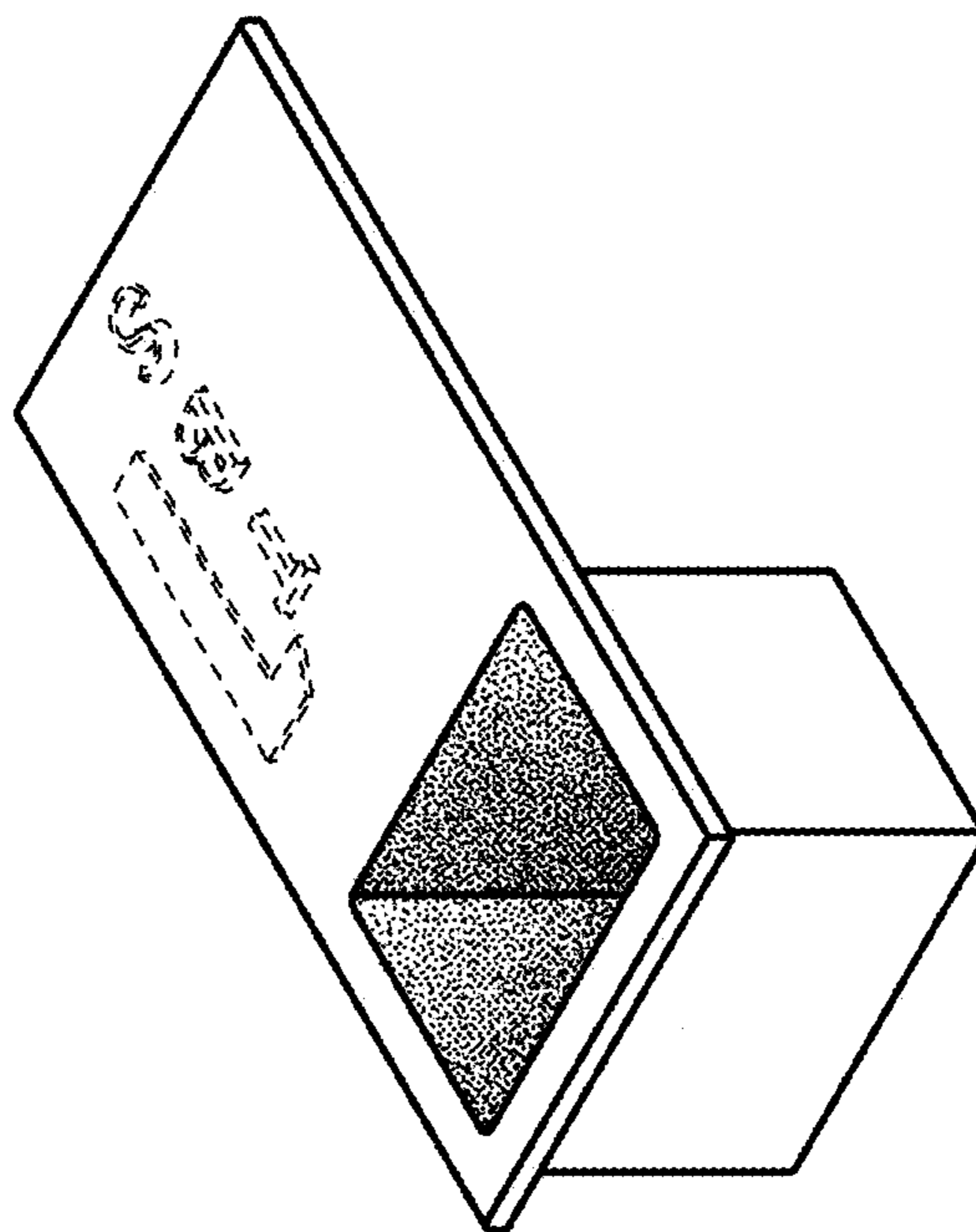

Fig. 23



Fig. 24

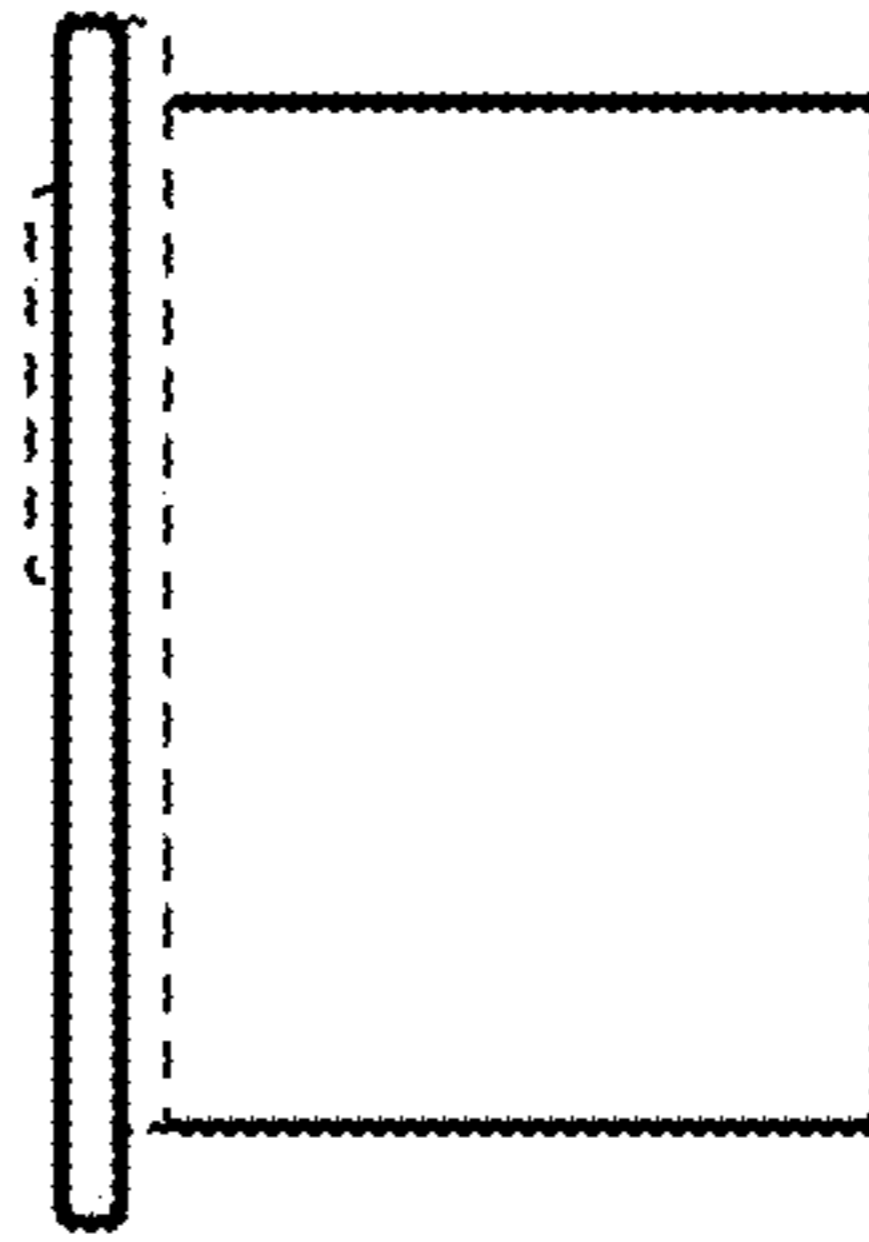

Fig. 25

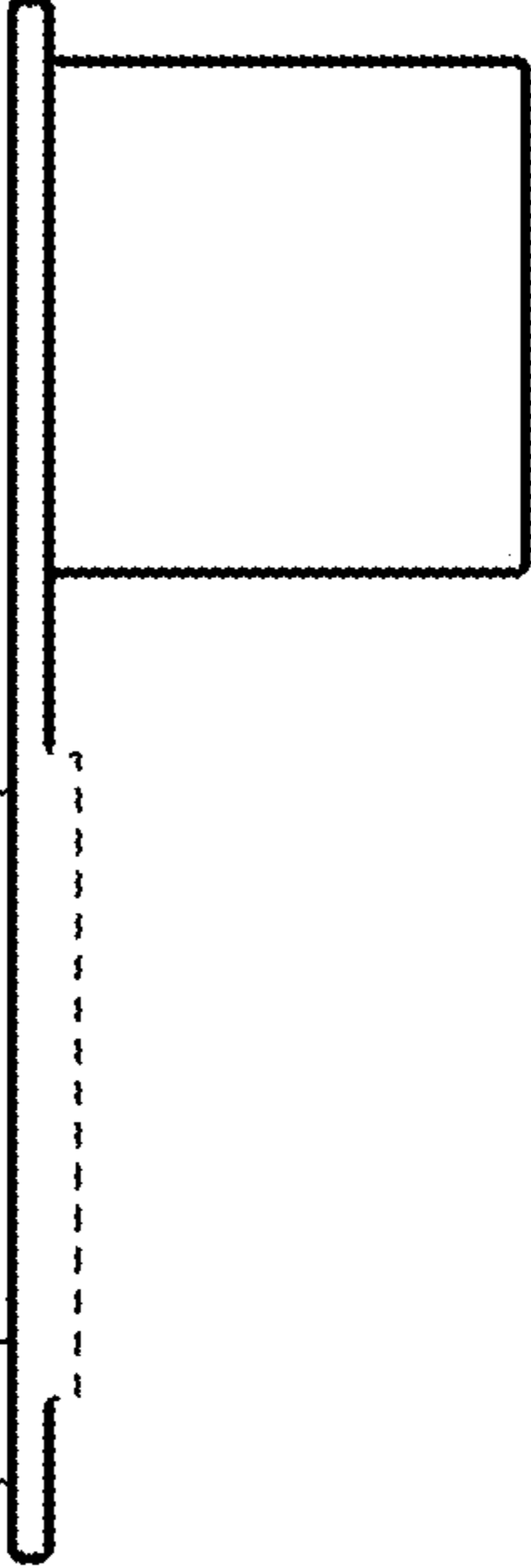

Fig. 26

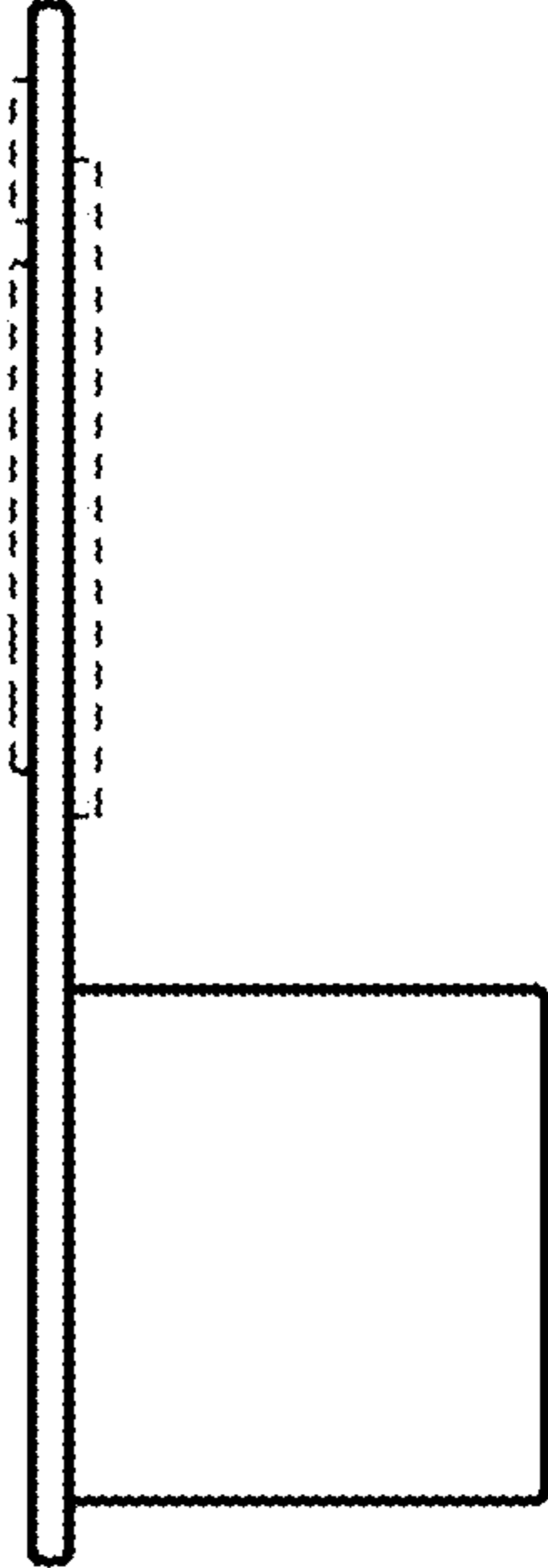
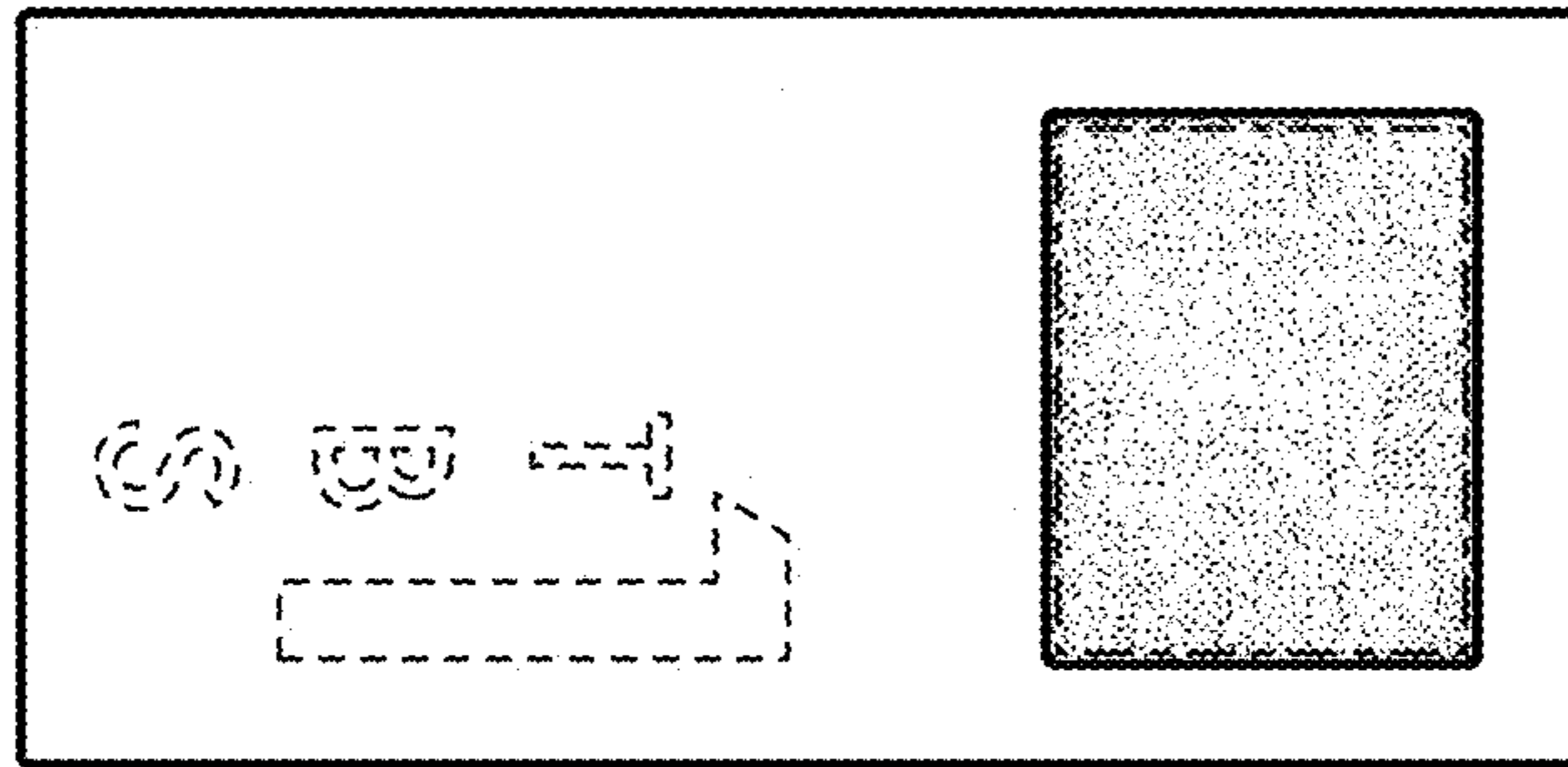

Fig. 27

Fig. 28



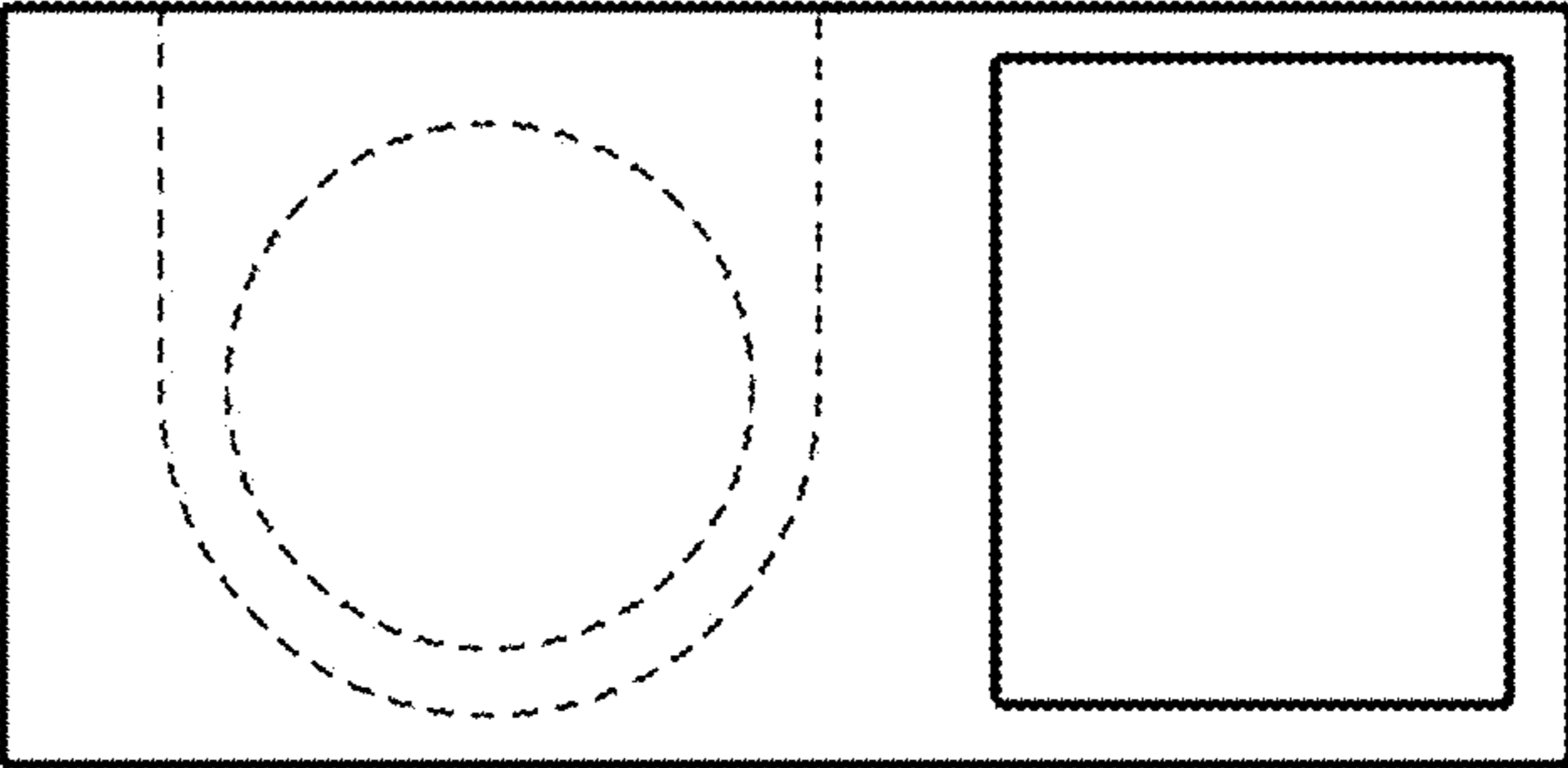

Fig. 29

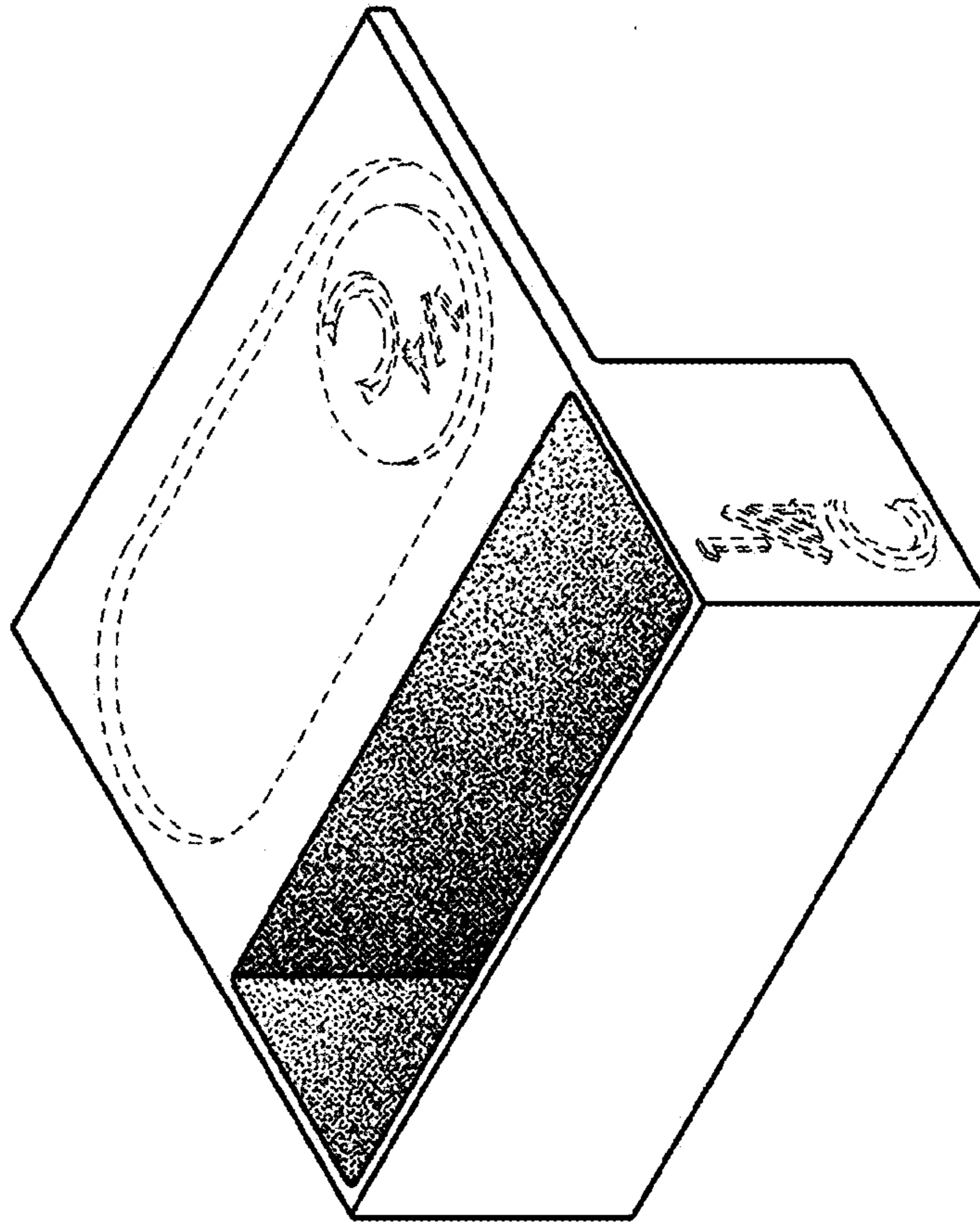

Fig. 30

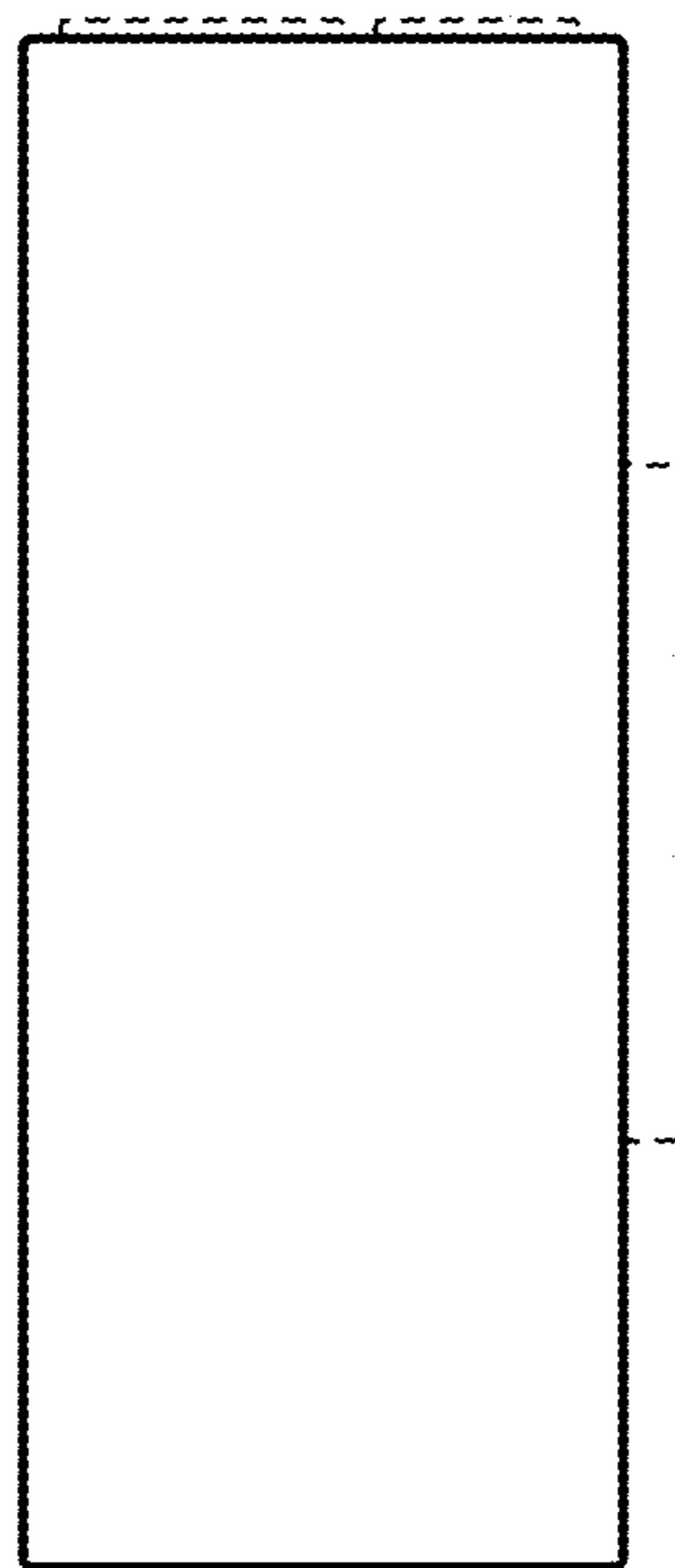

Fig. 31

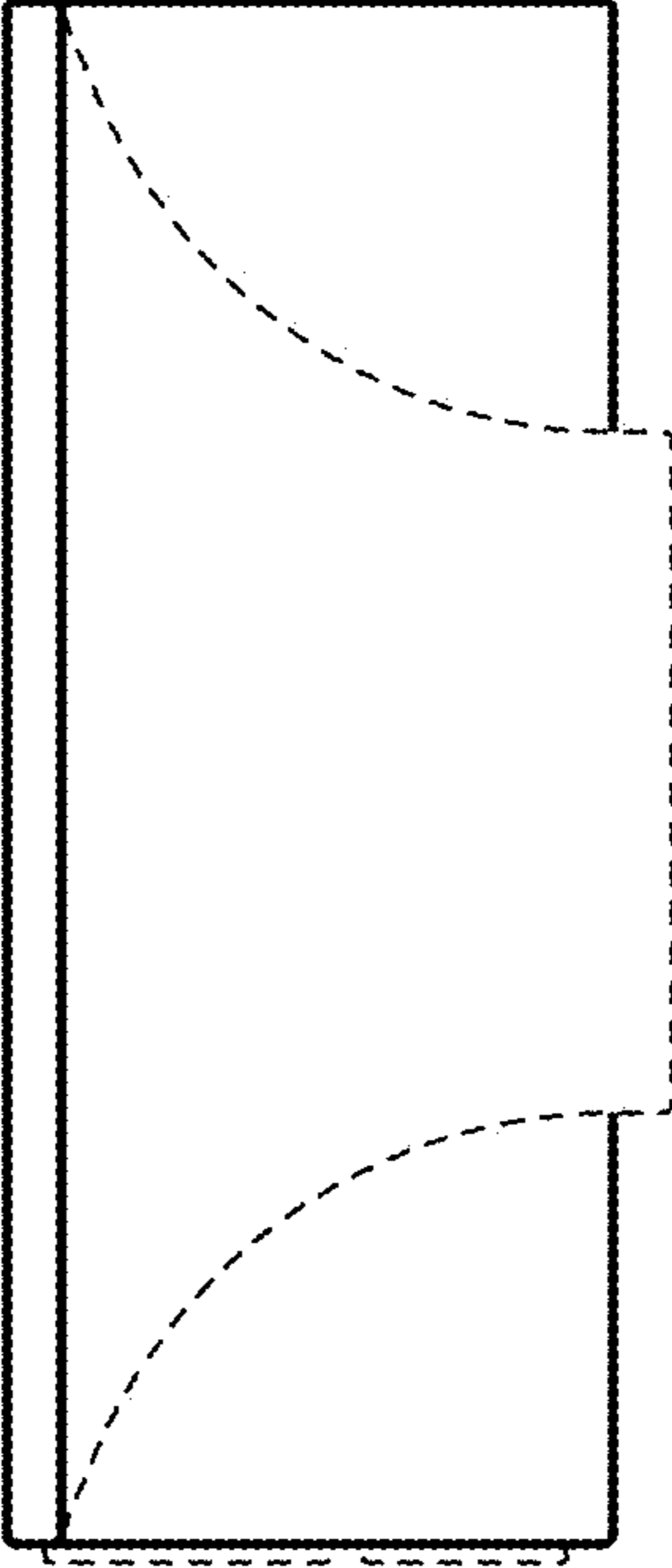

Fig. 32

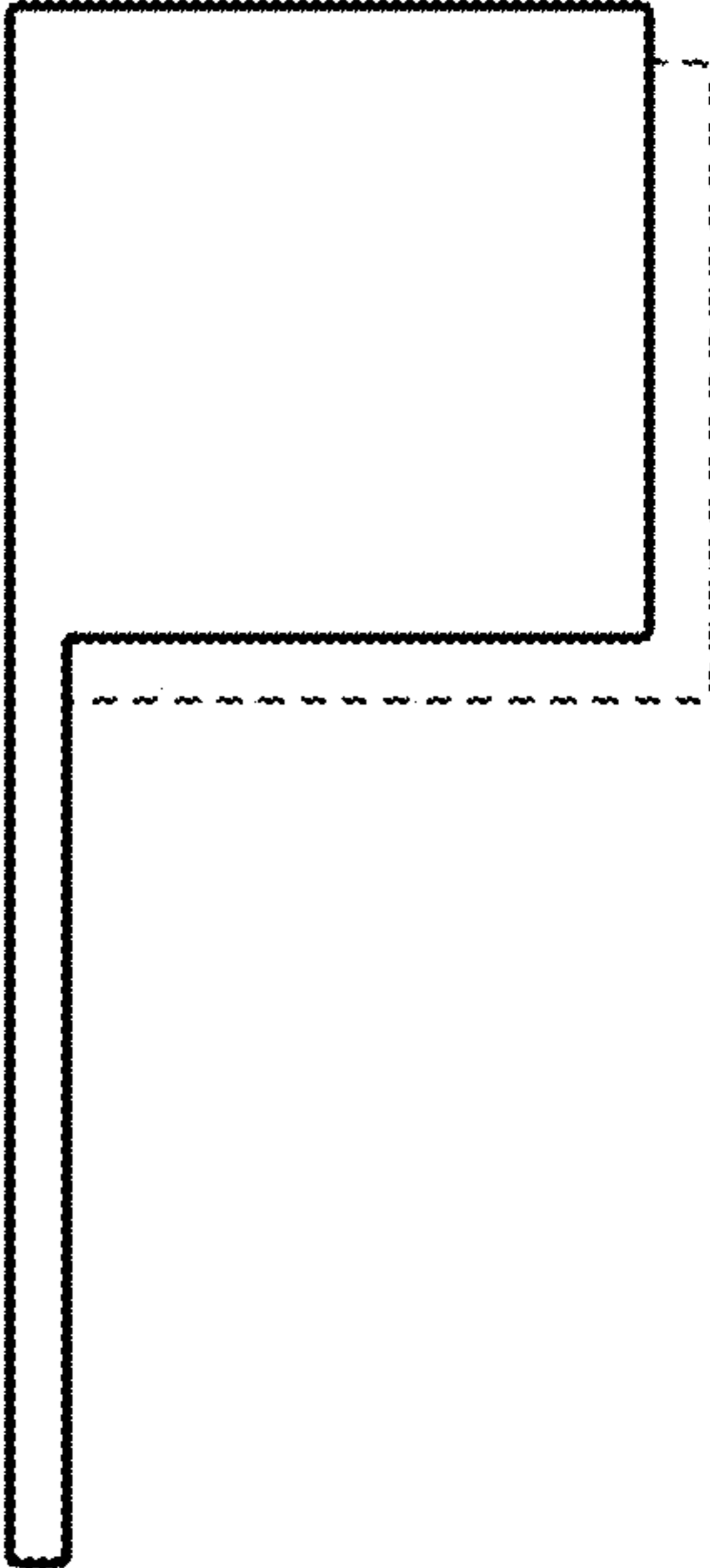

Fig. 33

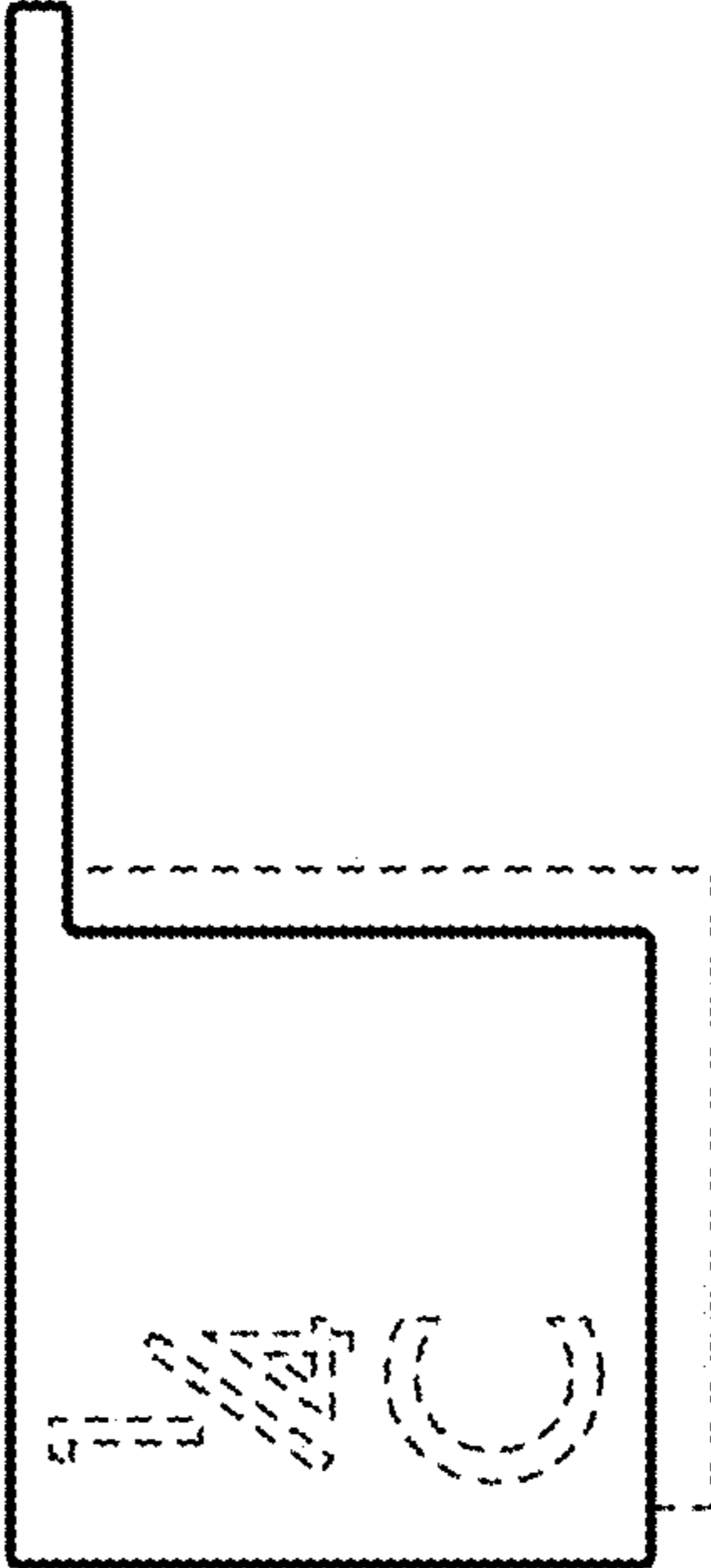
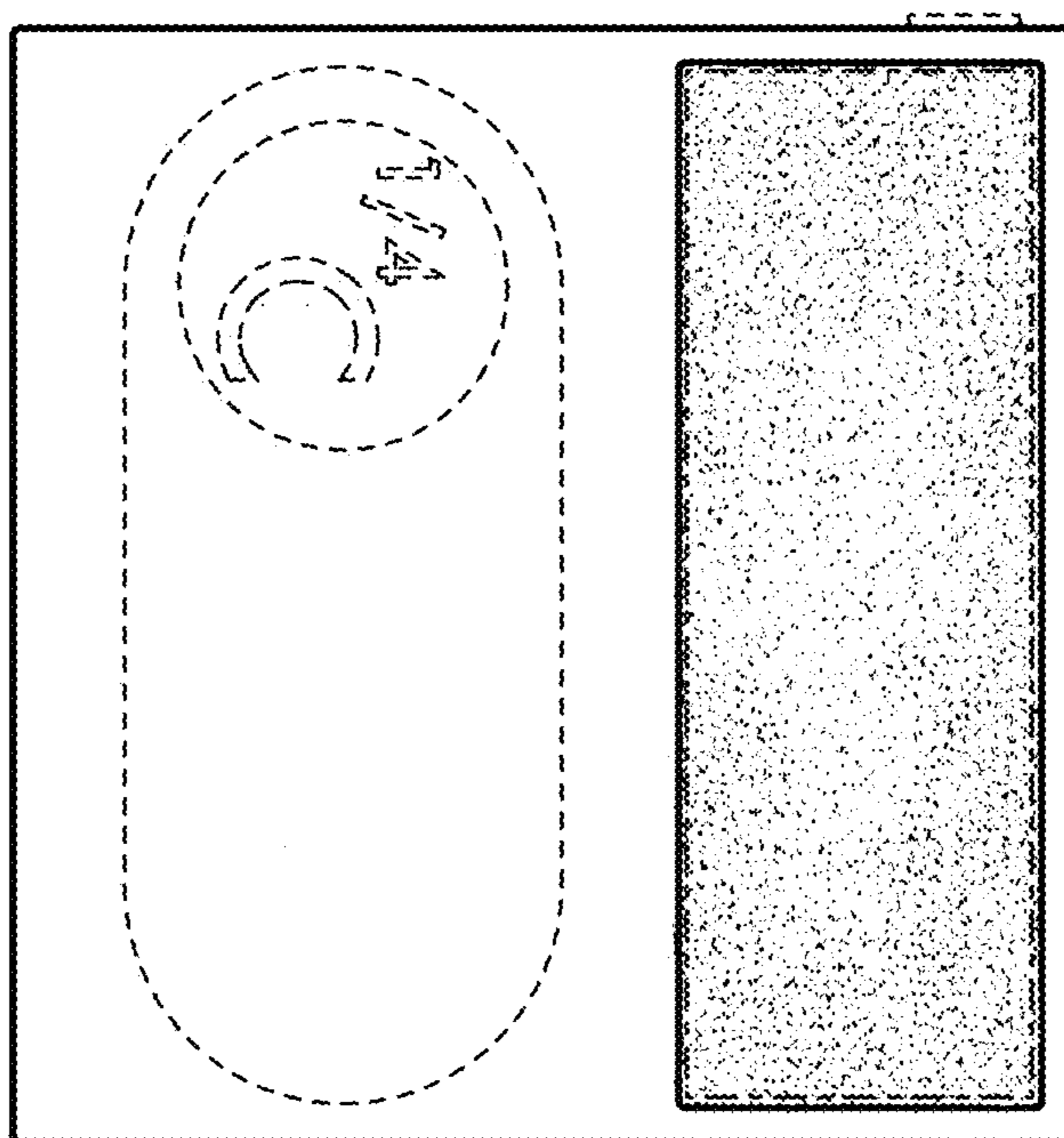

Fig. 34

Fig. 35



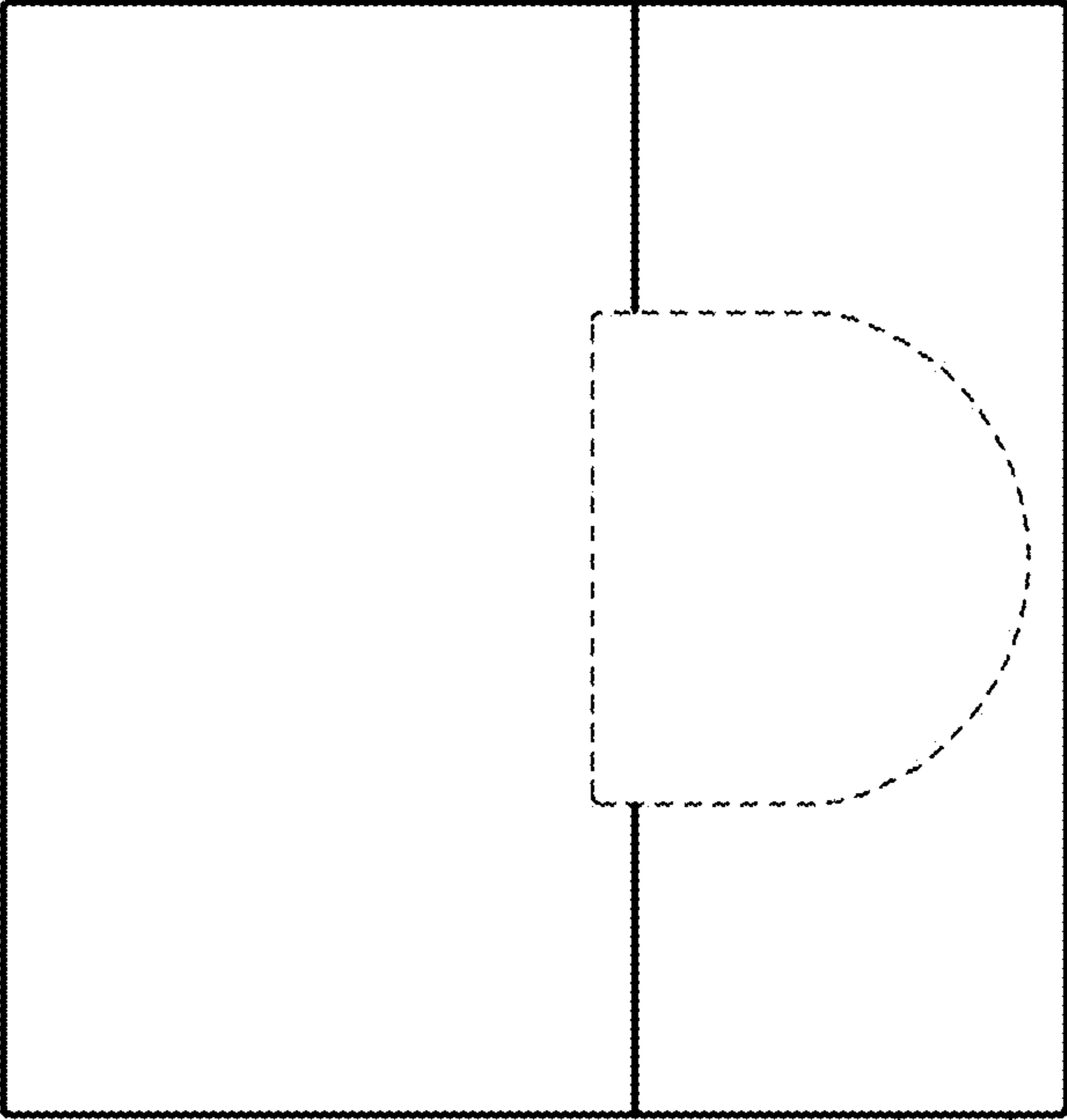

Fig. 36

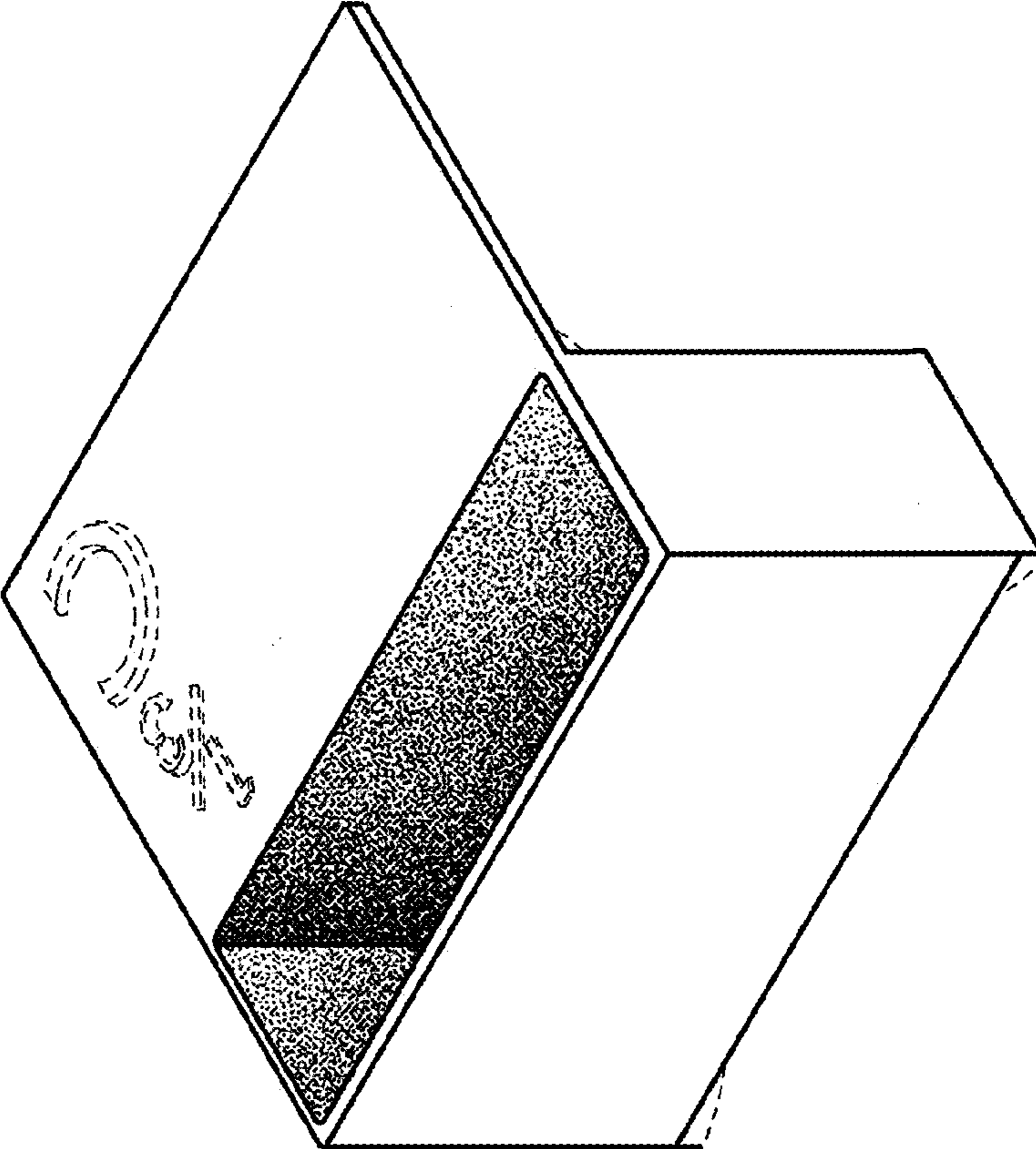

Fig. 37

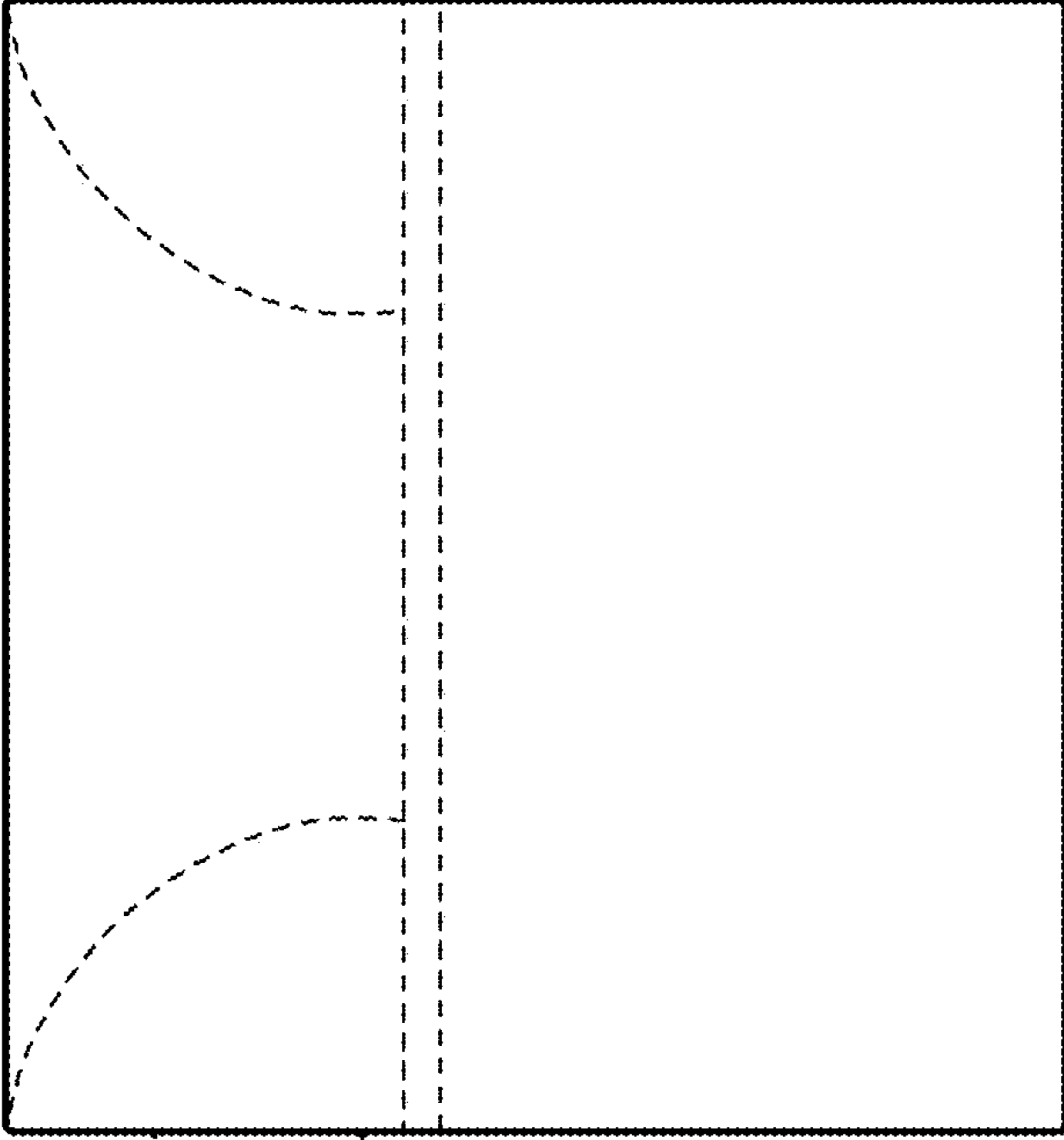
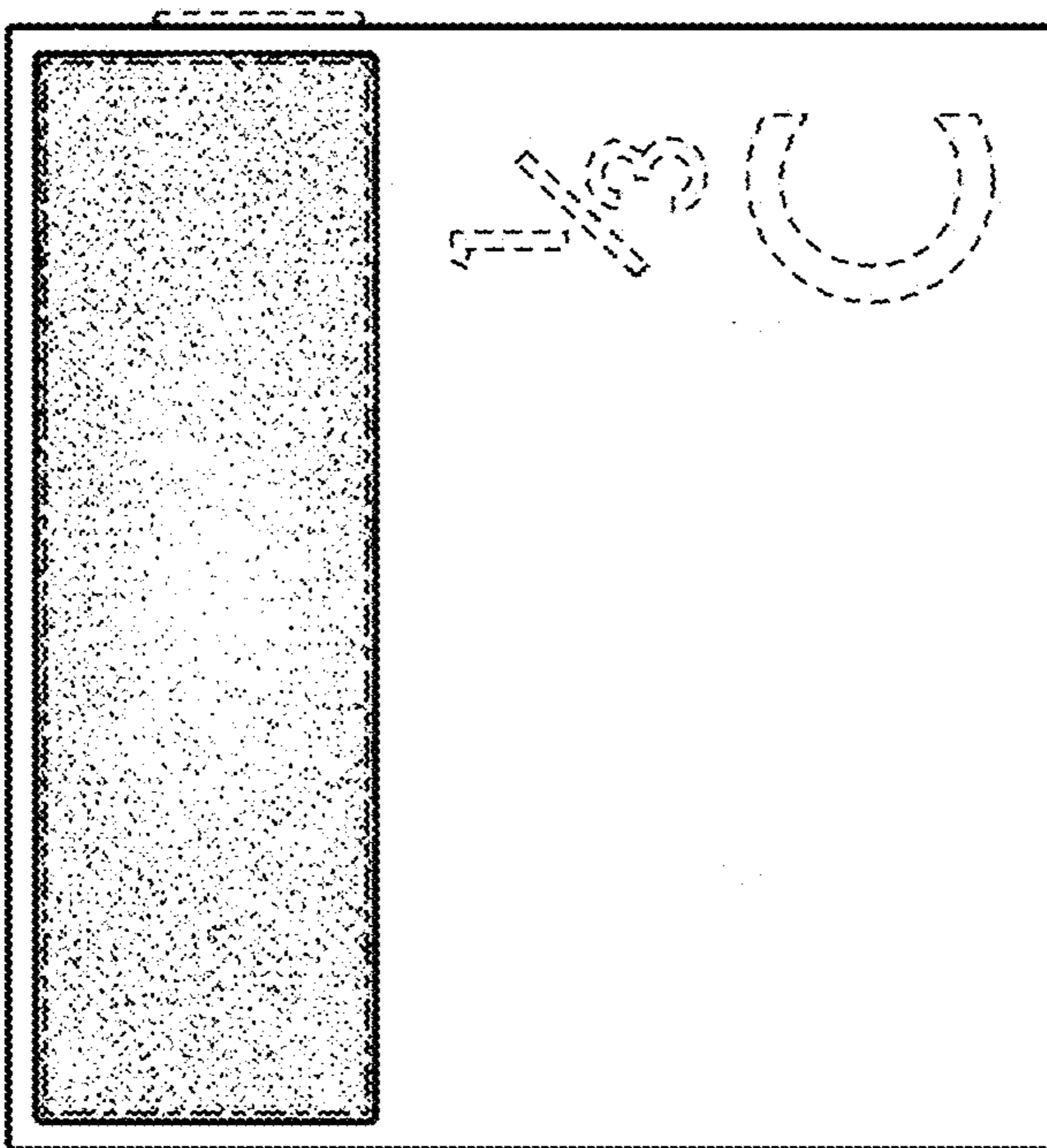

Fig. 38

Fig. 39



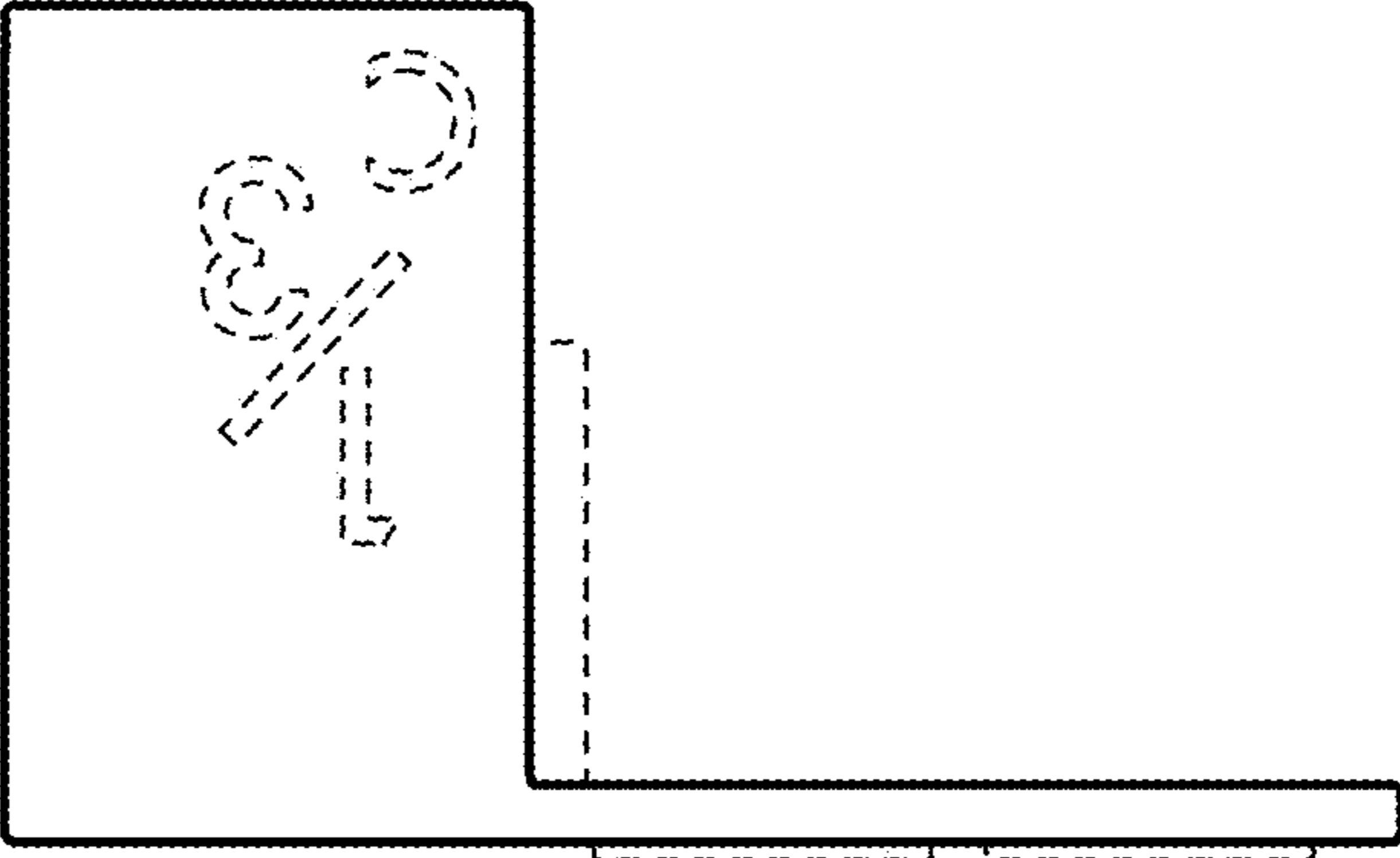

Fig. 40

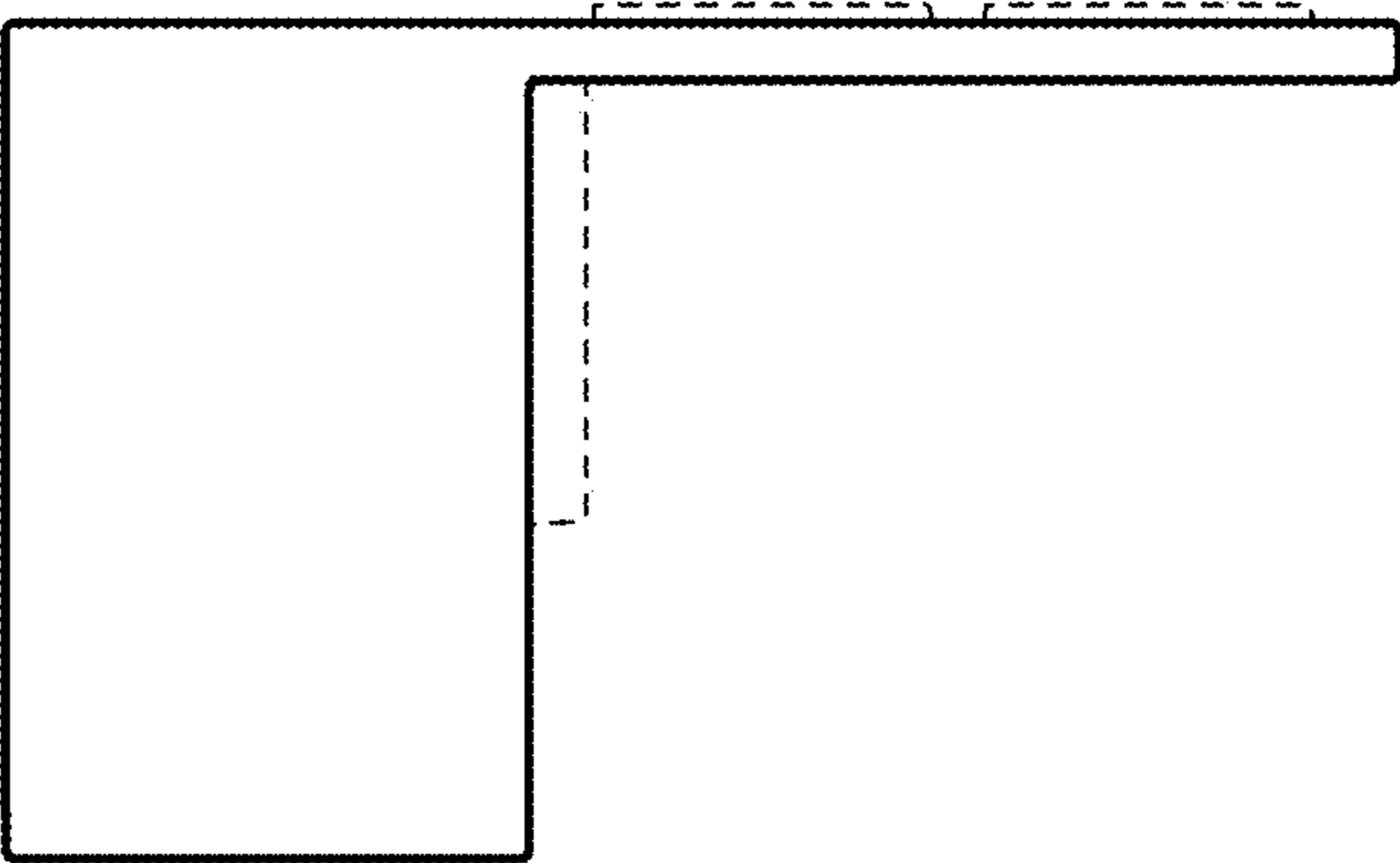

Fig. 41

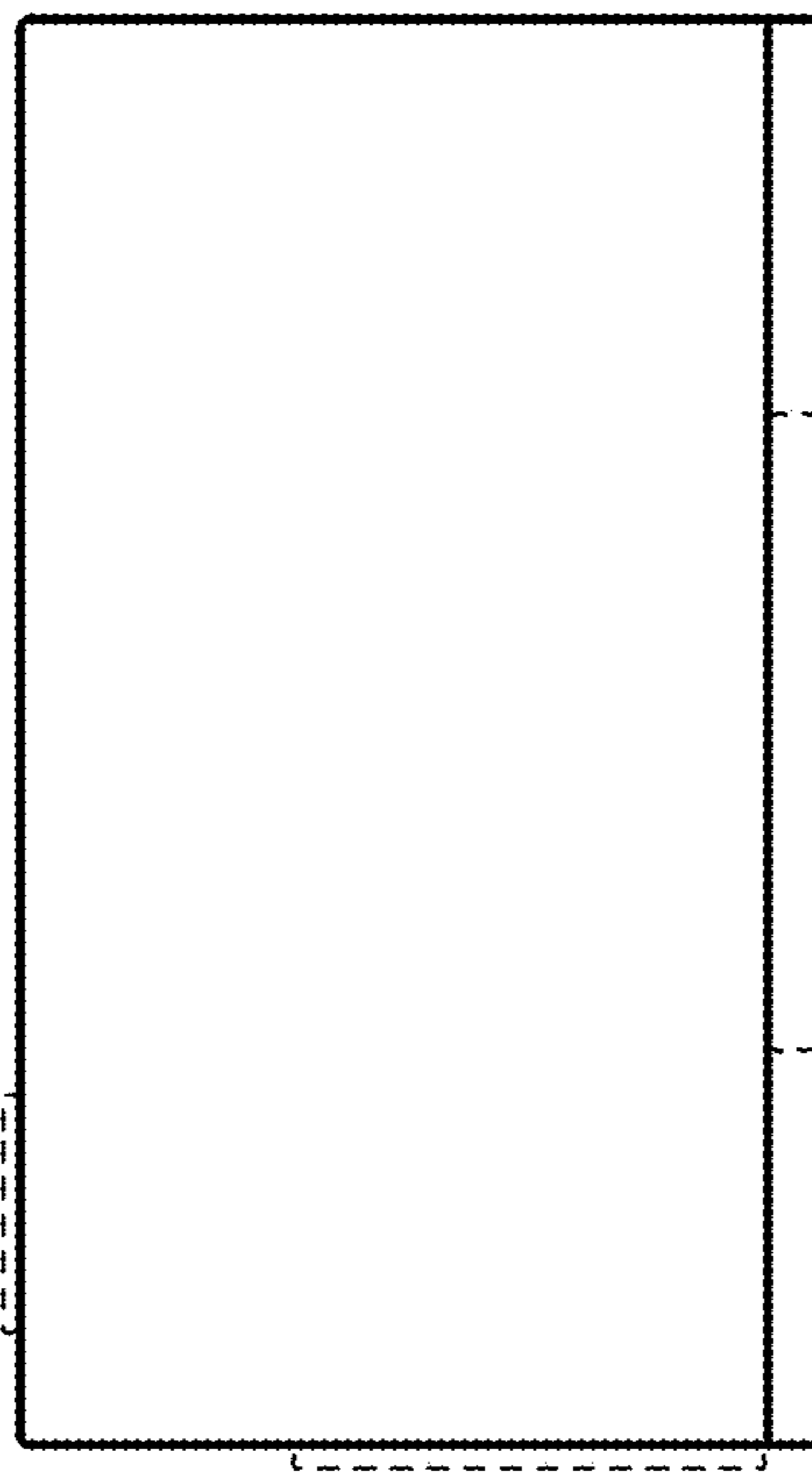

Fig. 42

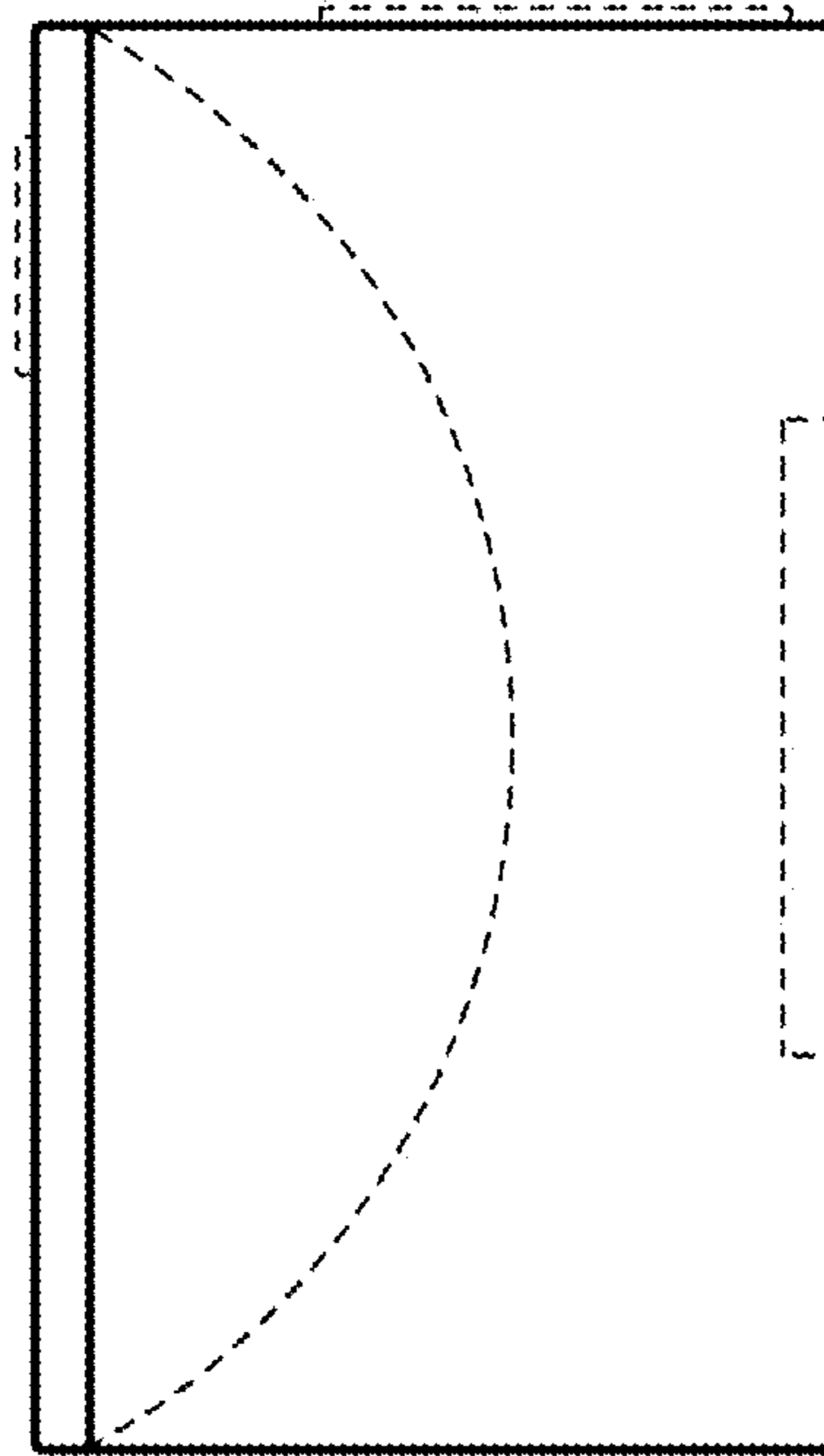

Fig. 43

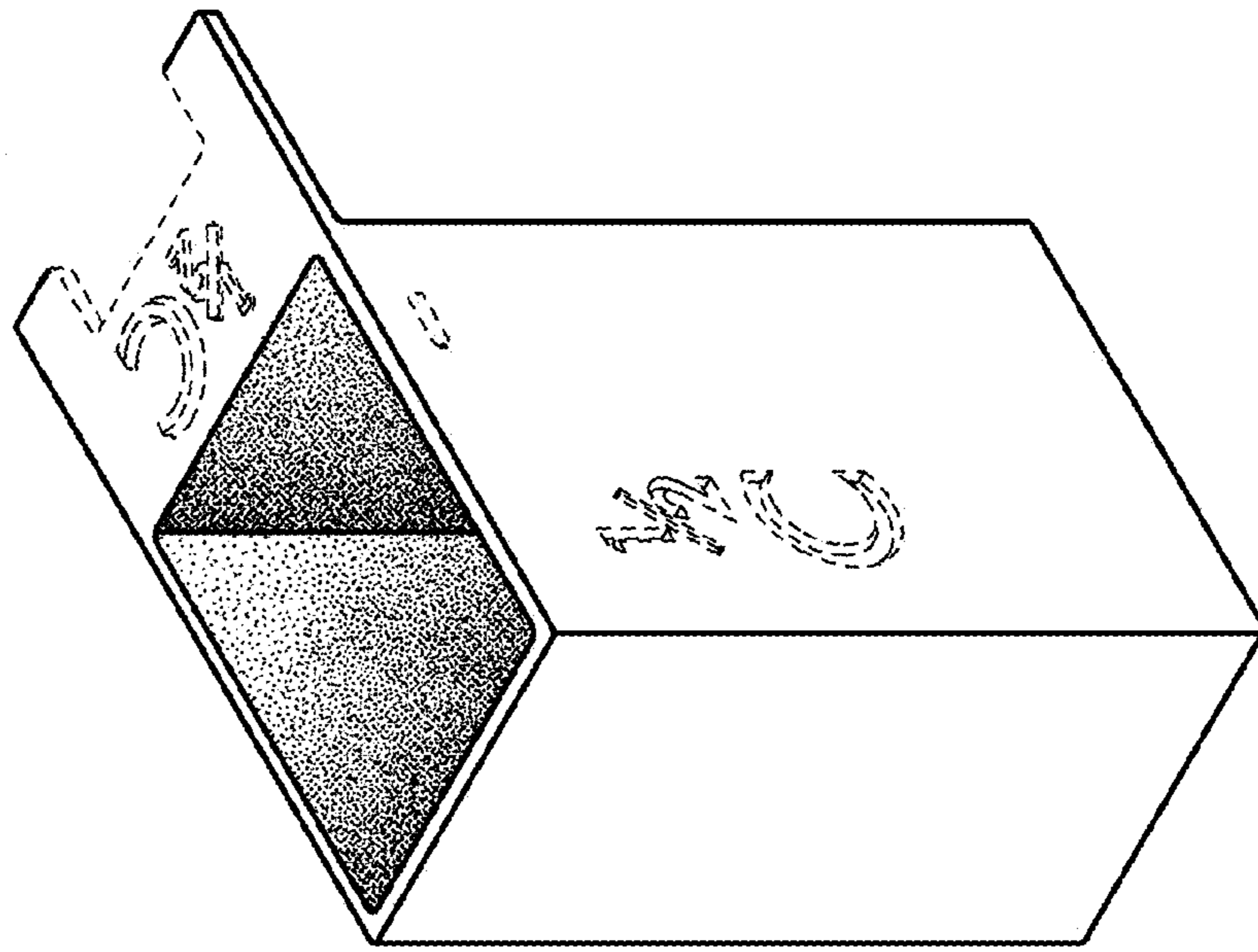
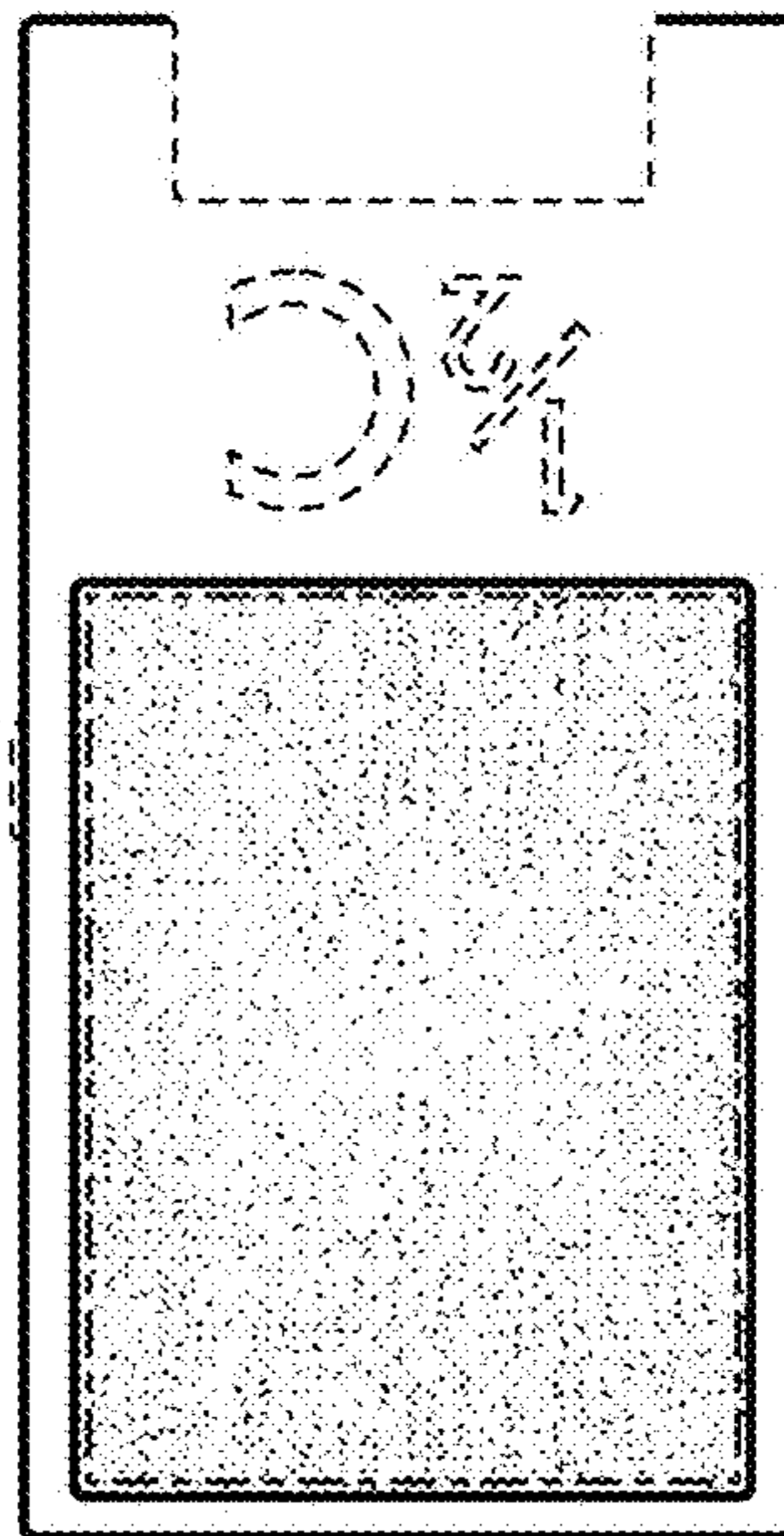

Fig. 44

Fig. 45



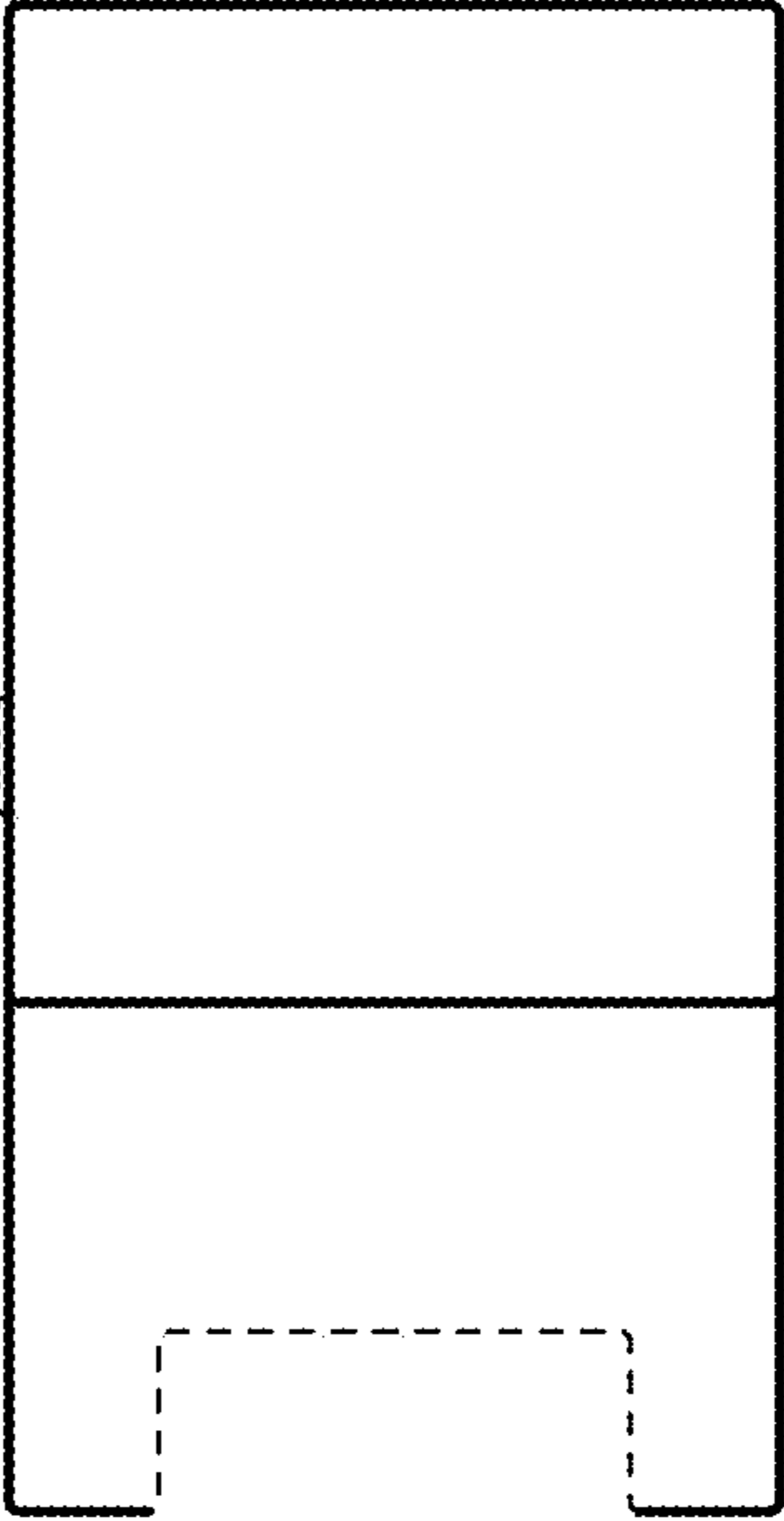

Fig. 46

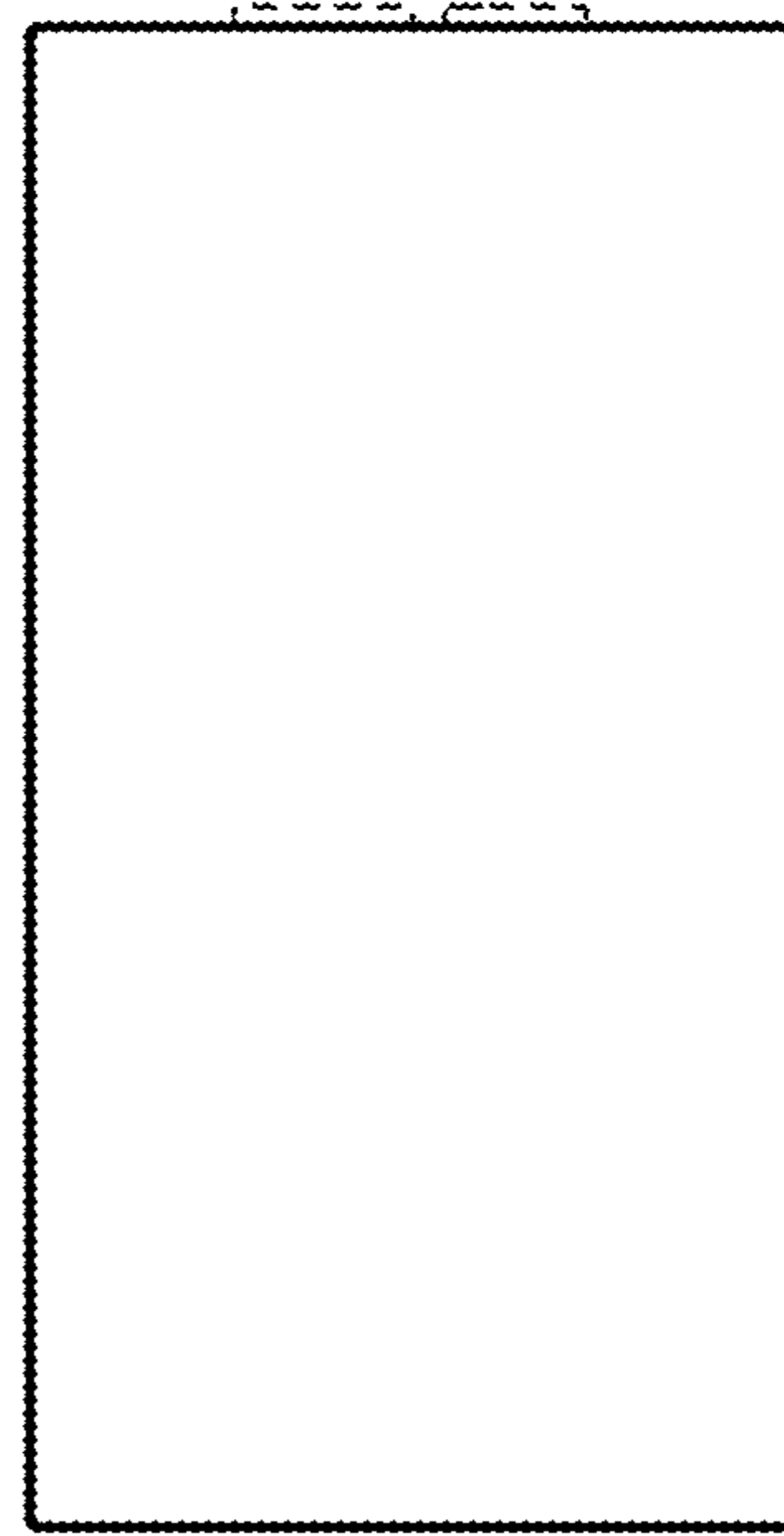

Fig. 47

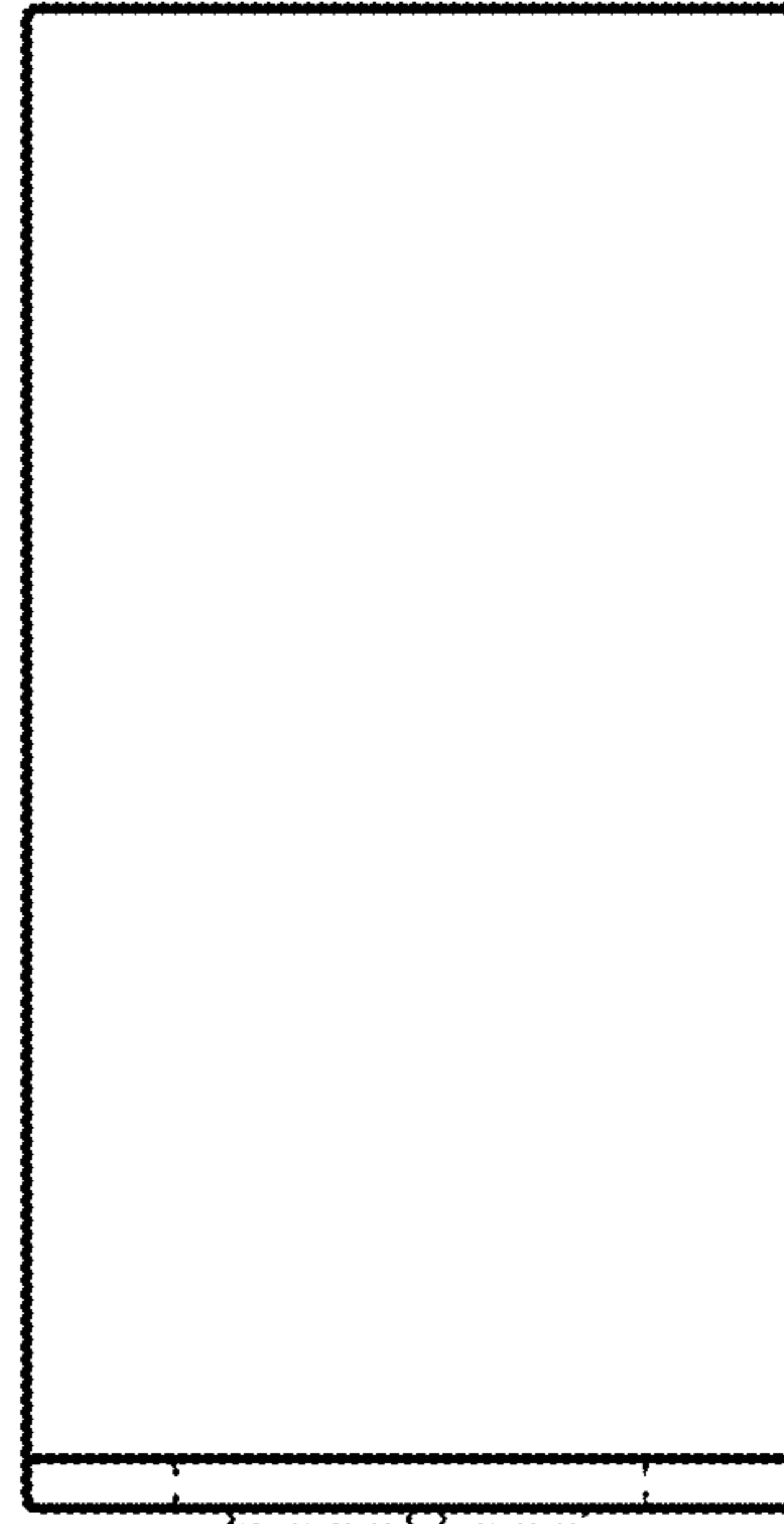

Fig. 48

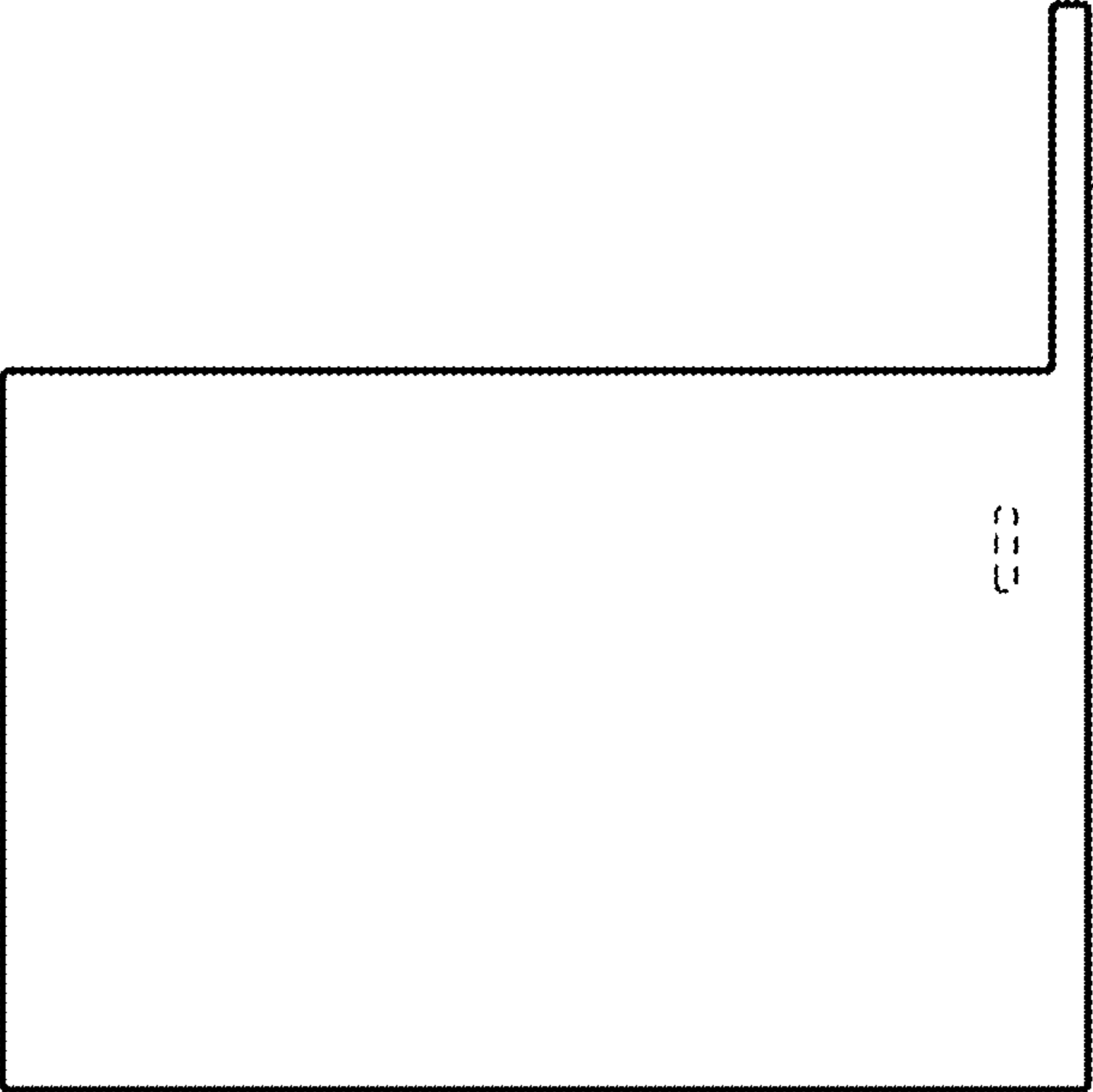

Fig. 49

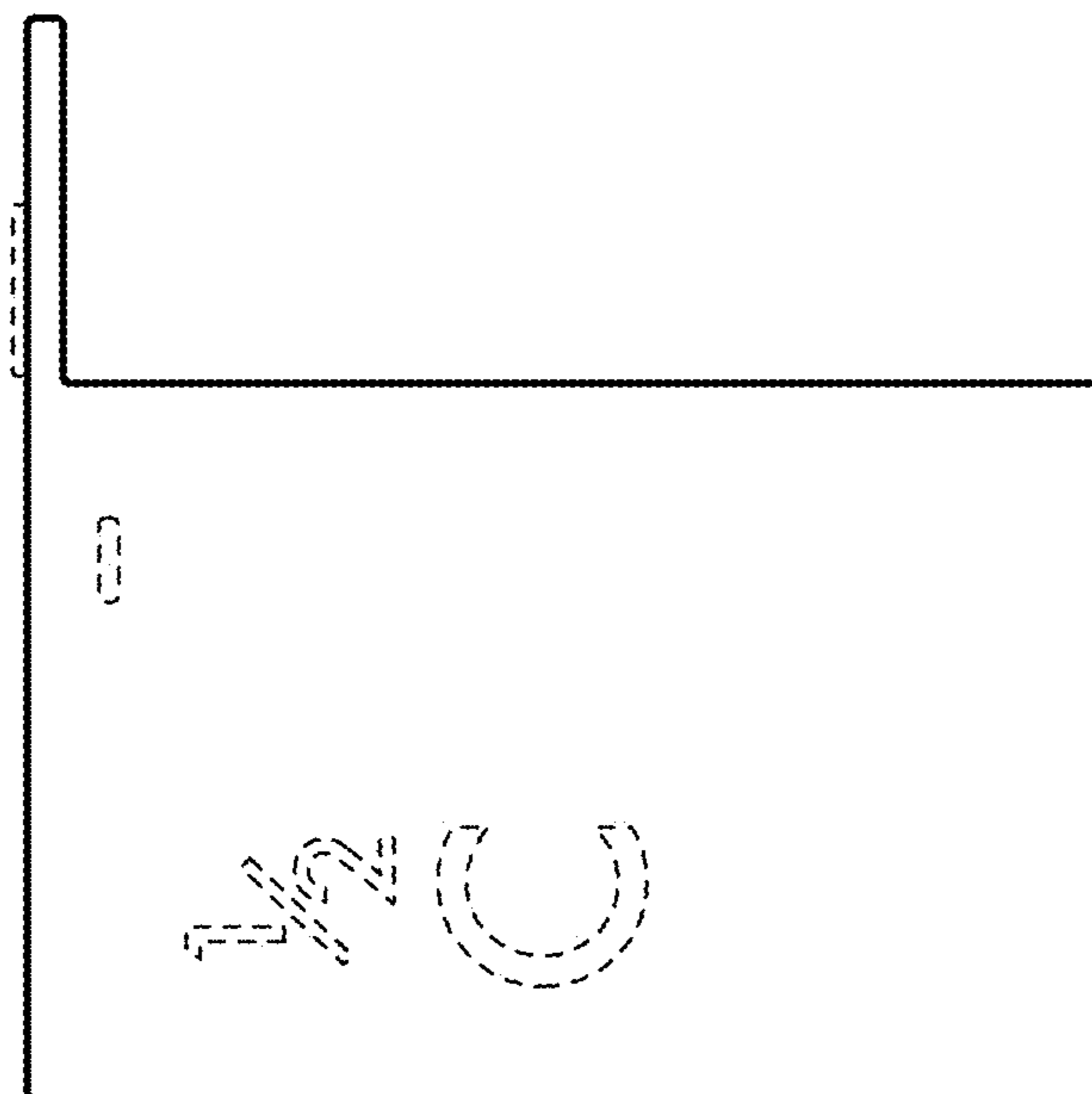

Fig. 50

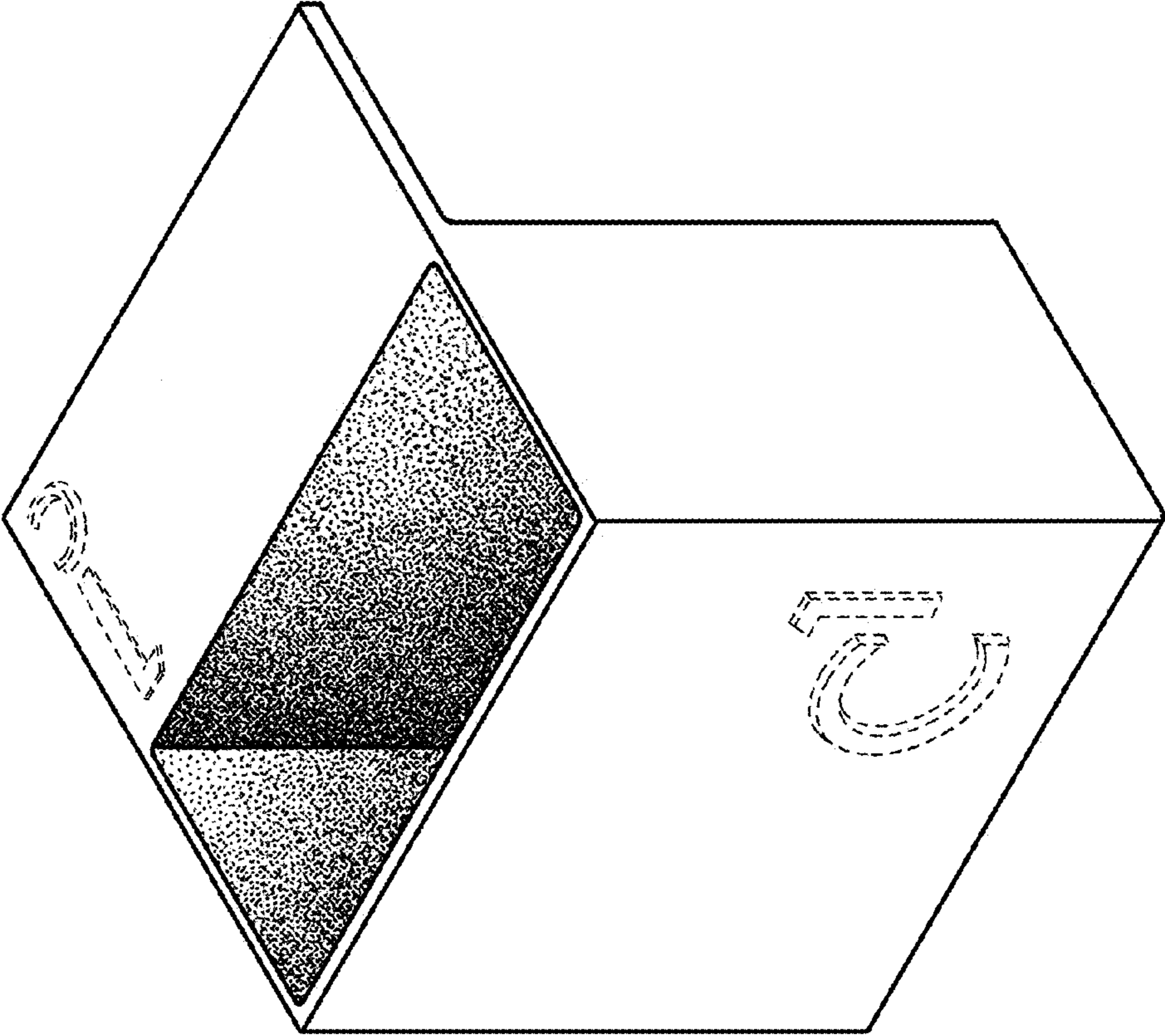
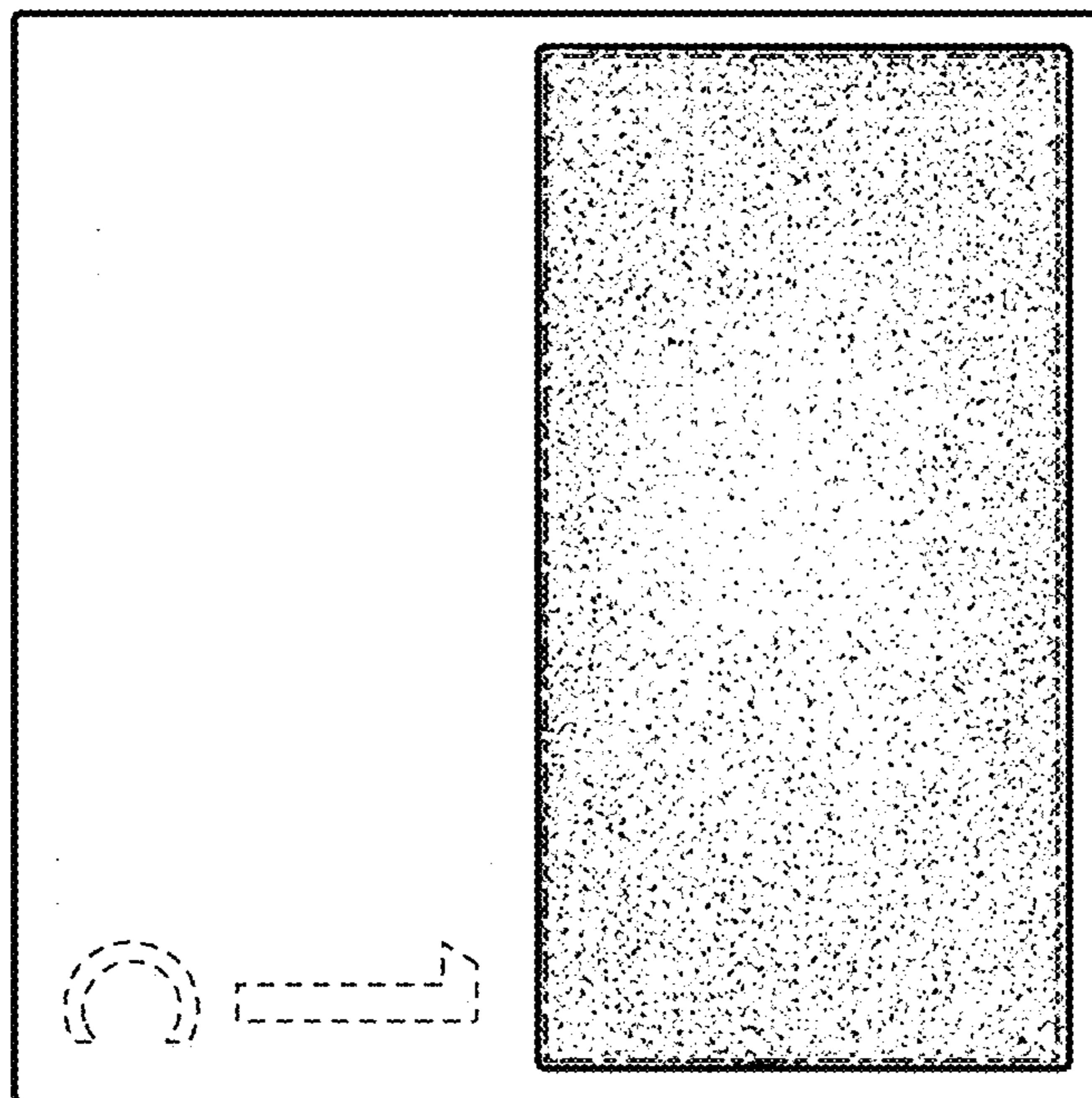

Fig. 51

Fig. 52



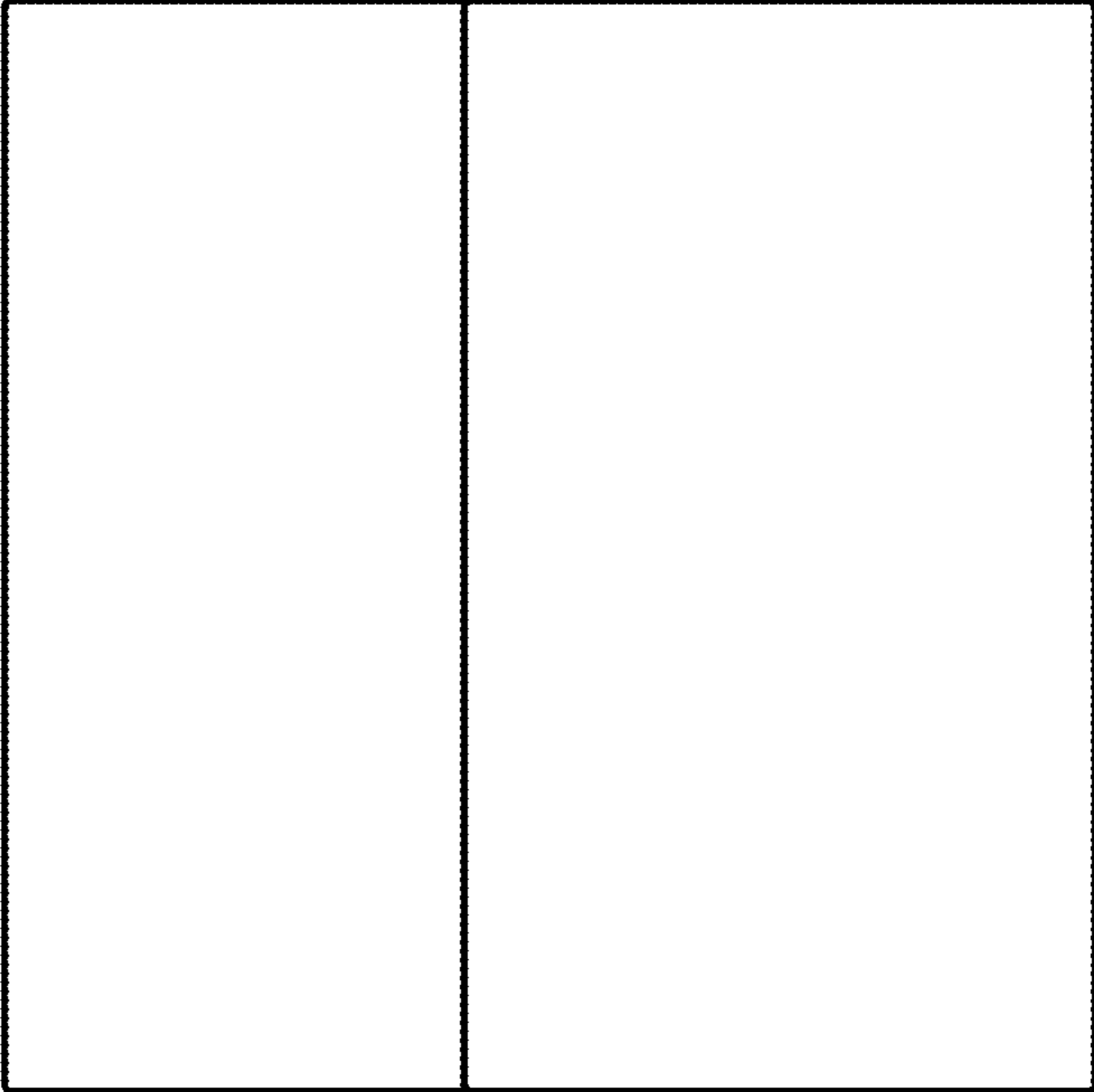

Fig. 53

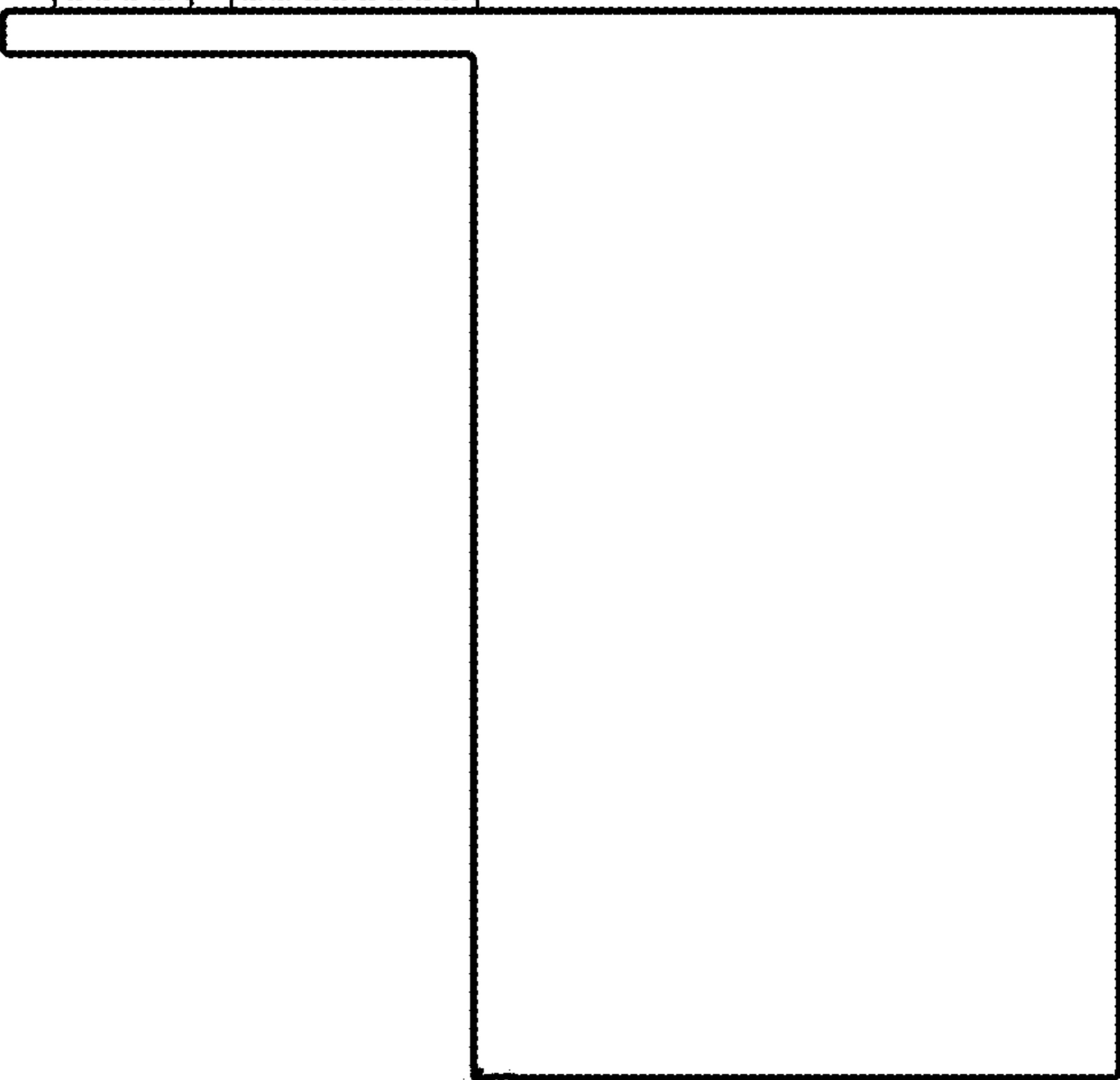

Fig. 54

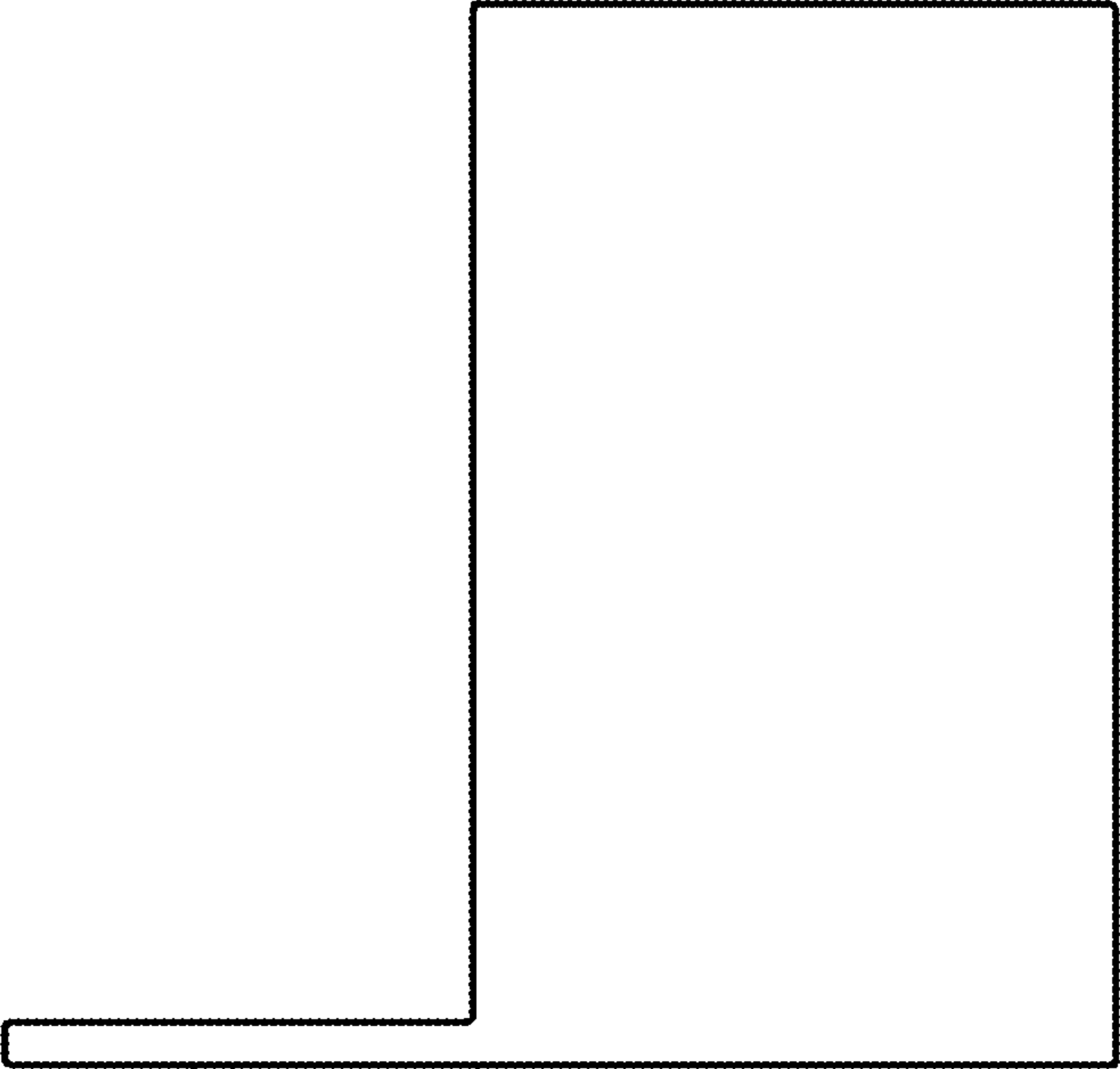

Fig. 55

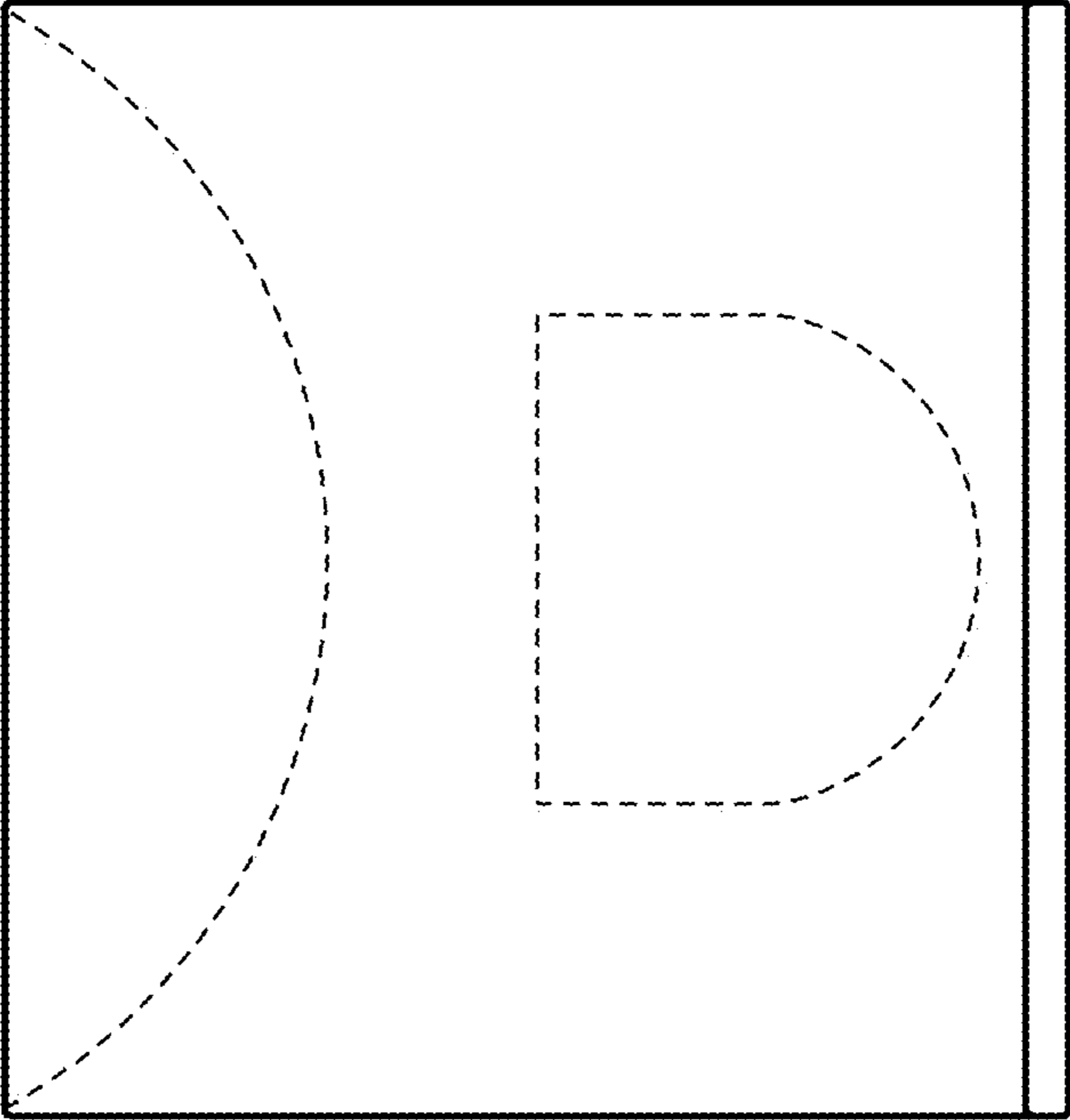

Fig. 56

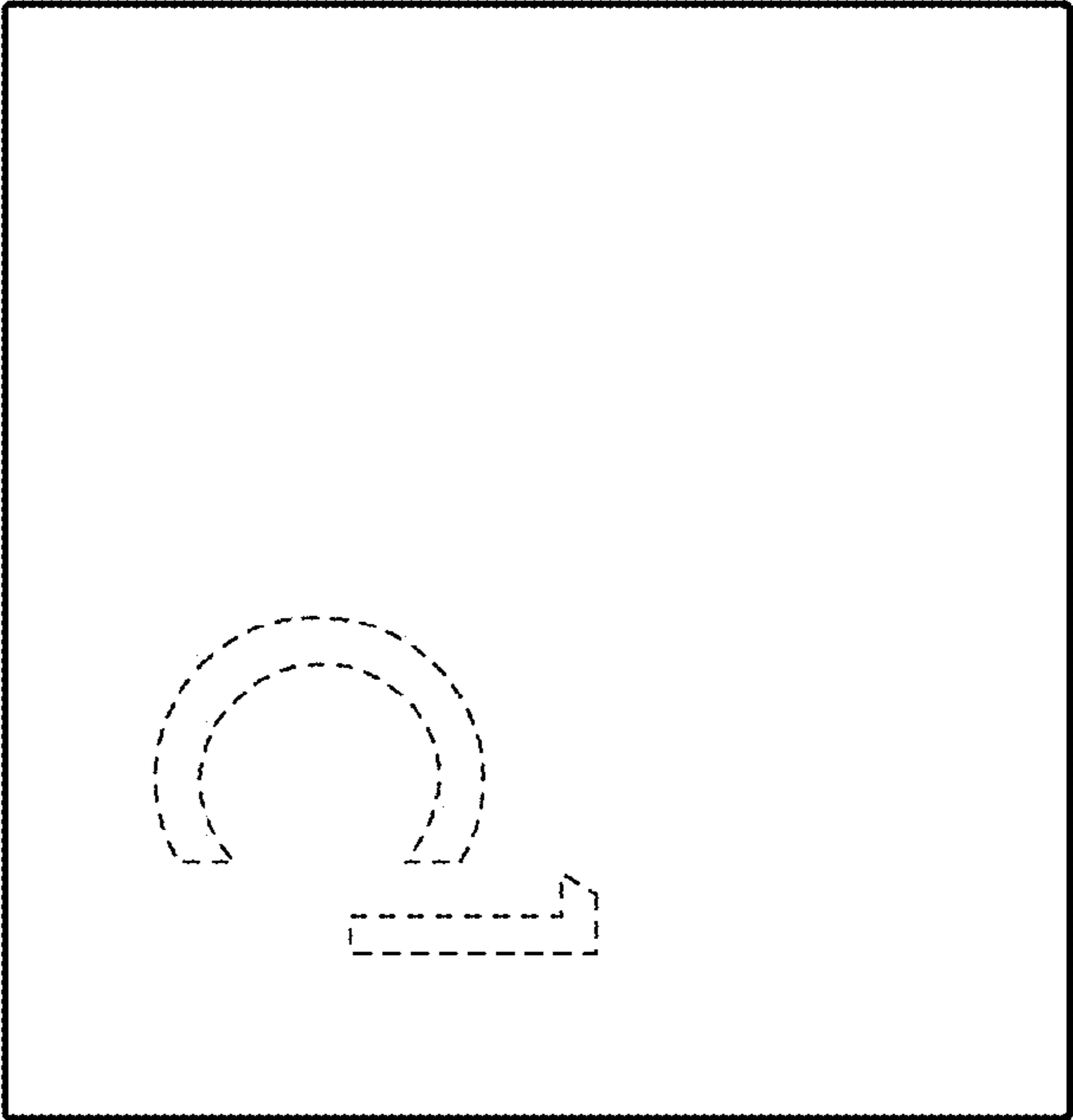

Fig. 57