



US00D738192S

(12) **United States Design Patent**
Hetfield et al.

(10) **Patent No.:** **US D738,192 S**
(45) **Date of Patent:** **** Sep. 8, 2015**

(54) **ESCUTCHEON**

FOREIGN PATENT DOCUMENTS

(71) Applicants: **Meg Hetfield**, New Haven, CT (US);
Rick Leites, West Haven, CT (US);
John E. Walsh, Wallingford, CT (US);
Garrett E. Lovejoy, Madison, CT (US);
Mark Bryla, Cumming, GA (US);
Douglas A. Clark, Wallingford, CT
(US); **Angelo S. Arcaria**, Colchester, CT
(US)

TW D129664 S 7/2009

OTHER PUBLICATIONS

Taiwan Patent Office, Taiwan Patent Application No. 102306180
Office Action with English translation dated Jan. 13, 2014, pp. 1-4.
Canadian Patent Office, Canadian Patent Application No. 153042
Office Action dated Mar. 26, 2014, pp. 1-2.
Sargent Manufacturing Company, Mexican Office Action MX/f/
2013/002760, Office Action, Mar. 4, 2015.

(72) Inventors: **Meg Hetfield**, New Haven, CT (US);
Rick Leites, West Haven, CT (US);
John E. Walsh, Wallingford, CT (US);
Garrett E. Lovejoy, Madison, CT (US);
Mark Bryla, Cumming, GA (US);
Douglas A. Clark, Wallingford, CT
(US); **Angelo S. Arcaria**, Colchester, CT
(US)

* cited by examiner

Primary Examiner — Holly Baynham

(74) *Attorney, Agent, or Firm* — Michael G. Johnston;
Moore and Van Allen PLLC

(73) Assignee: **Sargent Manufacturing Company**,
New Haven, CT (US)

(57) **CLAIM**

The ornamental design for an escutcheon, as shown and
described.

(**) Term: **14 Years**

DESCRIPTION

(21) Appl. No.: **29/449,541**

(22) Filed: **Mar. 15, 2013**

(51) **LOC (10) Cl.** **08-05**

(52) **U.S. Cl.**
USPC **D8/350**

(58) **Field of Classification Search**
USPC D8/350, 352
CPC ... E05B 43/005; E05B 43/00; E05B 37/0031;
E05B 37/003; G07C 9/006
See application file for complete search history.

FIG. 1 is a perspective view of an escutcheon showing an a
first embodiment of our new design;
FIG. 2 is a front elevation view of the escutcheon as shown in
FIG. 1;
FIG. 3 is a rear elevation view of the escutcheon as shown in
FIG. 1;
FIG. 4 is a left side elevation view of the escutcheon as shown
in FIG. 1, the right side view of which is a mirror image of the
left side view;
FIG. 5 is a top plan view of the escutcheon as shown in FIG.
1;
FIG. 6 is a bottom plan view of the escutcheon as shown in
FIG. 1;
FIG. 7 is a perspective view of the escutcheon as shown in
FIG. 1 with environmental features of a door and door hard-
ware shown;
FIG. 8 is a perspective view of an escutcheon showing a
second embodiment of our new design;
FIG. 9 is a front elevation view of the escutcheon as shown in
FIG. 8;

(56) **References Cited**

U.S. PATENT DOCUMENTS

D199,485 S * 11/1964 Parriott D8/350
D552,968 S * 10/2007 Roberts et al. D8/350
D601,002 S * 9/2009 Nunez et al. D8/350
D601,003 S * 9/2009 Nunez et al. D8/350
D602,762 S * 10/2009 Nunez et al. D8/350
D637,474 S * 5/2011 Schneider et al. D8/350

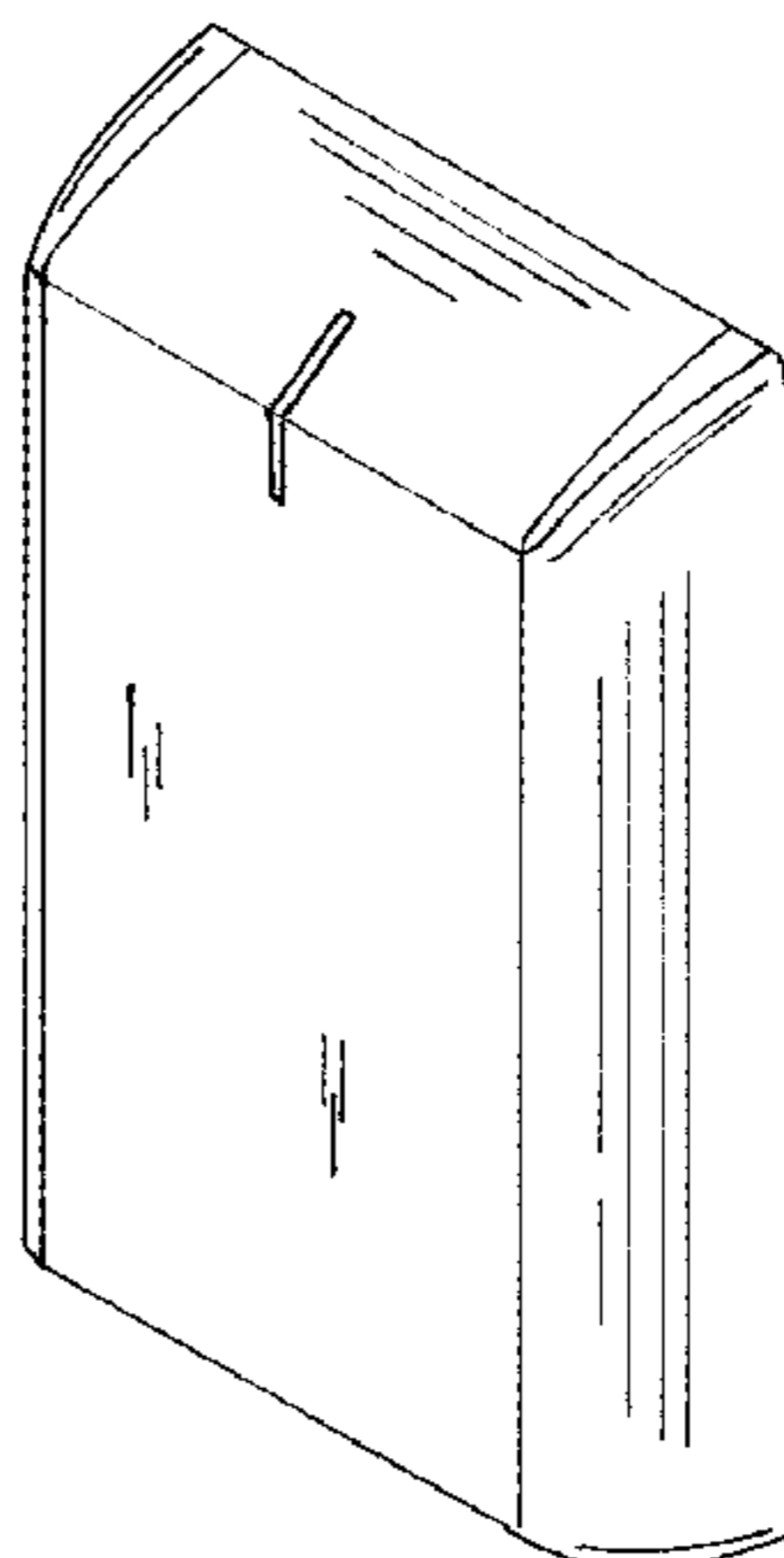

FIG. 10 is a rear elevation view of the escutcheon as shown in FIG. 8;

FIG. 11 is a left side elevation view of the escutcheon as shown in FIG. 8, the right side view of which is a mirror image of the left side view;

FIG. 12 is a top plan view of the escutcheon as shown in FIG. 8;

FIG. 13 is a bottom plan view of the escutcheon as shown in FIG. 8;

FIG. 14 is a perspective view of the escutcheon as shown in FIG. 8 with environmental features of a door and door hardware shown;

FIG. 15 is a perspective view of an escutcheon showing an a third embodiment of our new design;

FIG. 16 is a front elevation view of the escutcheon as shown in FIG. 15;

FIG. 17 is a rear elevation view of the escutcheon as shown in FIG. 15;

FIG. 18 is a right side elevation view of the escutcheon as shown in FIG. 15, the left side view of which is a mirror image of the right side view;

FIG. 19 is a top plan view of the escutcheon as shown in FIG. 15;

FIG. 20 is a bottom plan view of the escutcheon as shown in FIG. 15;

FIG. 21 is a perspective view of the escutcheon as shown in FIG. 15 with environmental features of a door and door hardware shown;

FIG. 22 is a perspective view of an escutcheon showing a fourth embodiment of our new design;

FIG. 23 is a front elevation view of the escutcheon as shown in FIG. 22;

FIG. 24 is a rear elevation view of the escutcheon as shown in FIG. 22;

FIG. 25 is a right side elevation view of the escutcheon as shown in FIG. 22, the left side view of which is a mirror image of the right side view;

FIG. 26 is a top plan view of the escutcheon as shown in FIG. 22;

FIG. 27 is a bottom plan view of the escutcheon as shown in FIG. 22; and,

FIG. 28 is a perspective view of the escutcheon as shown in FIG. 22 with environmental features of a door and door hardware shown.

The broken lines showing a back panel and indentations are included for the purpose of illustrating environmental structure and forms no part of the claimed design.

1 Claim, 16 Drawing Sheets

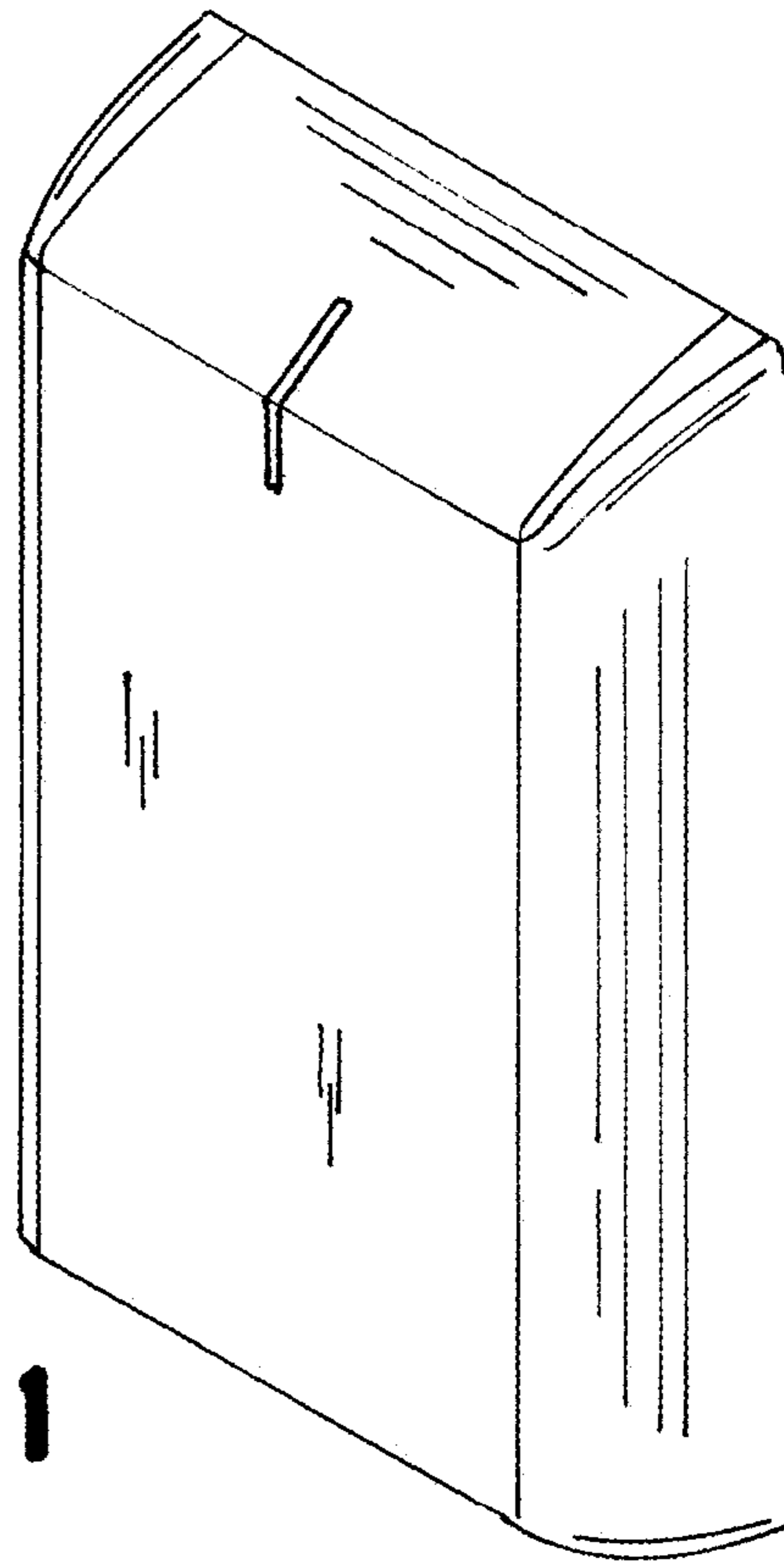

FIG. 1

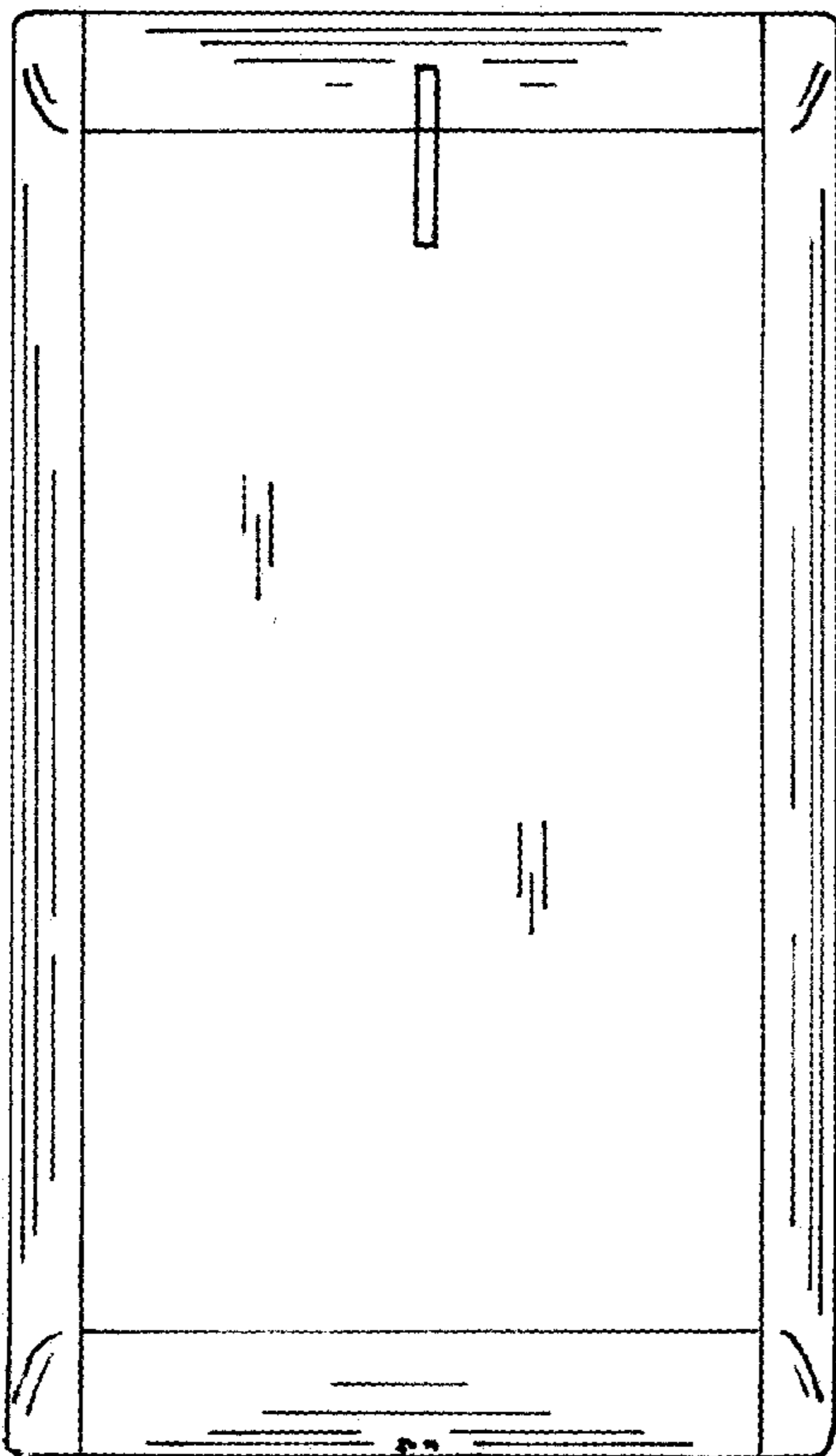

FIG. 2

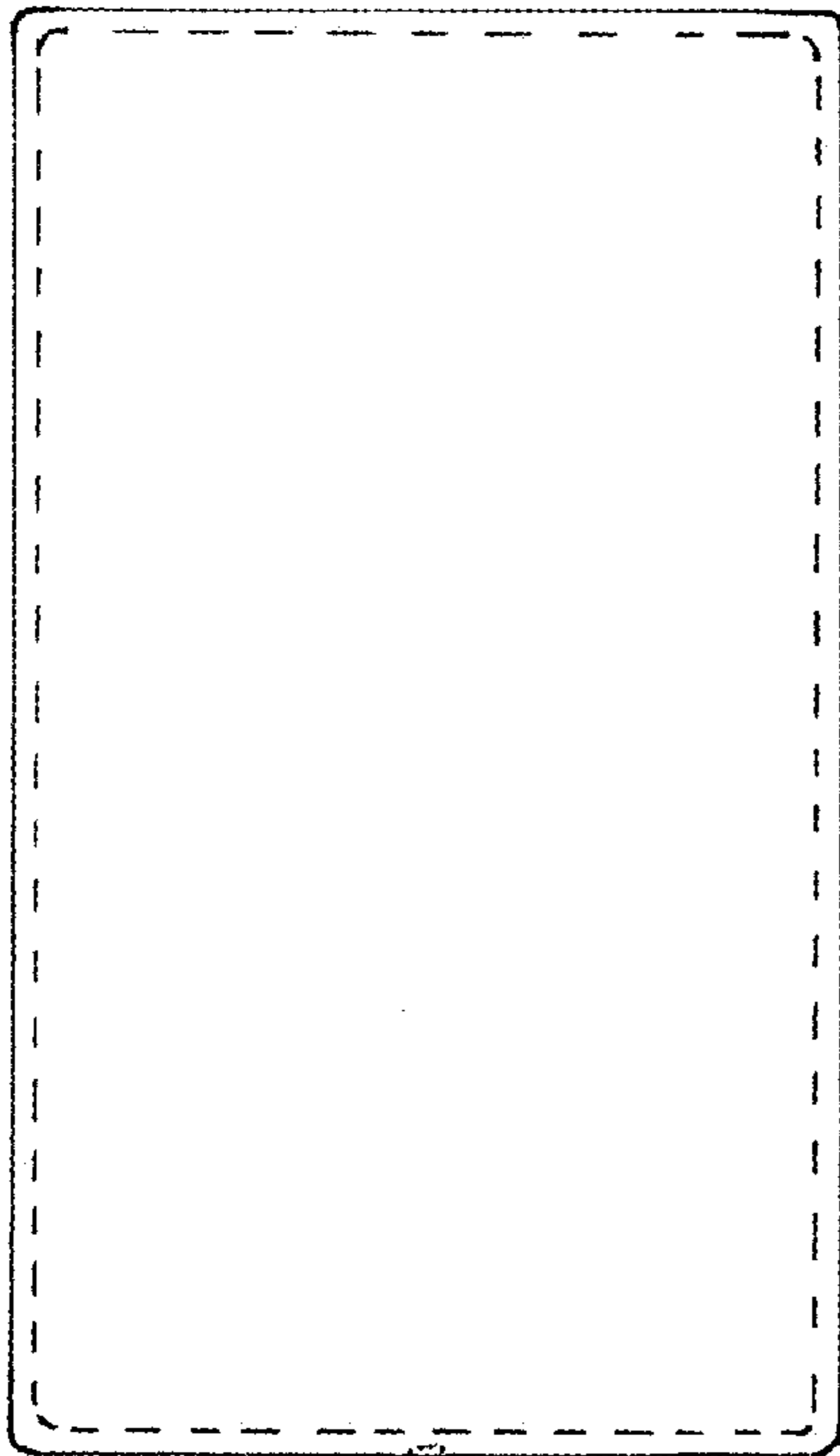

FIG. 3

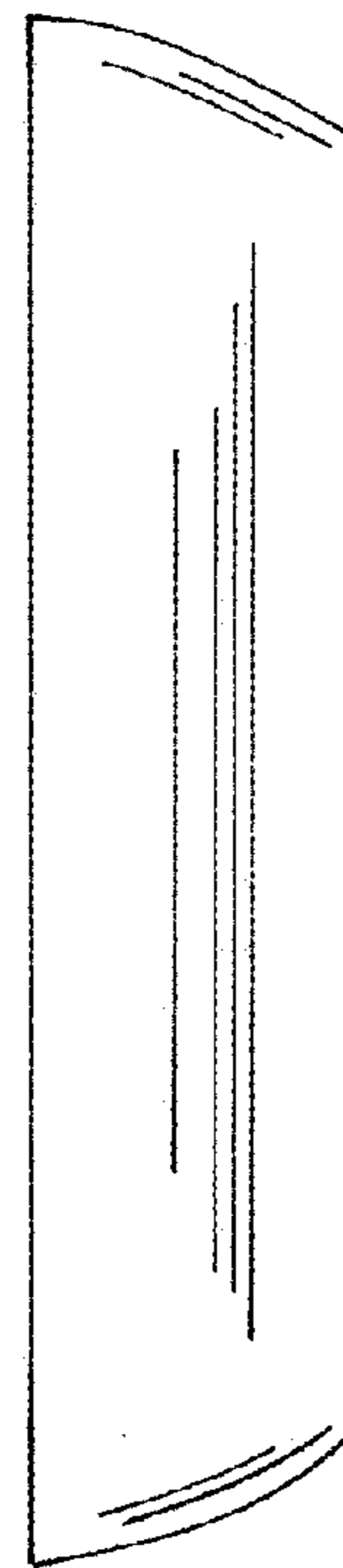

FIG. 4

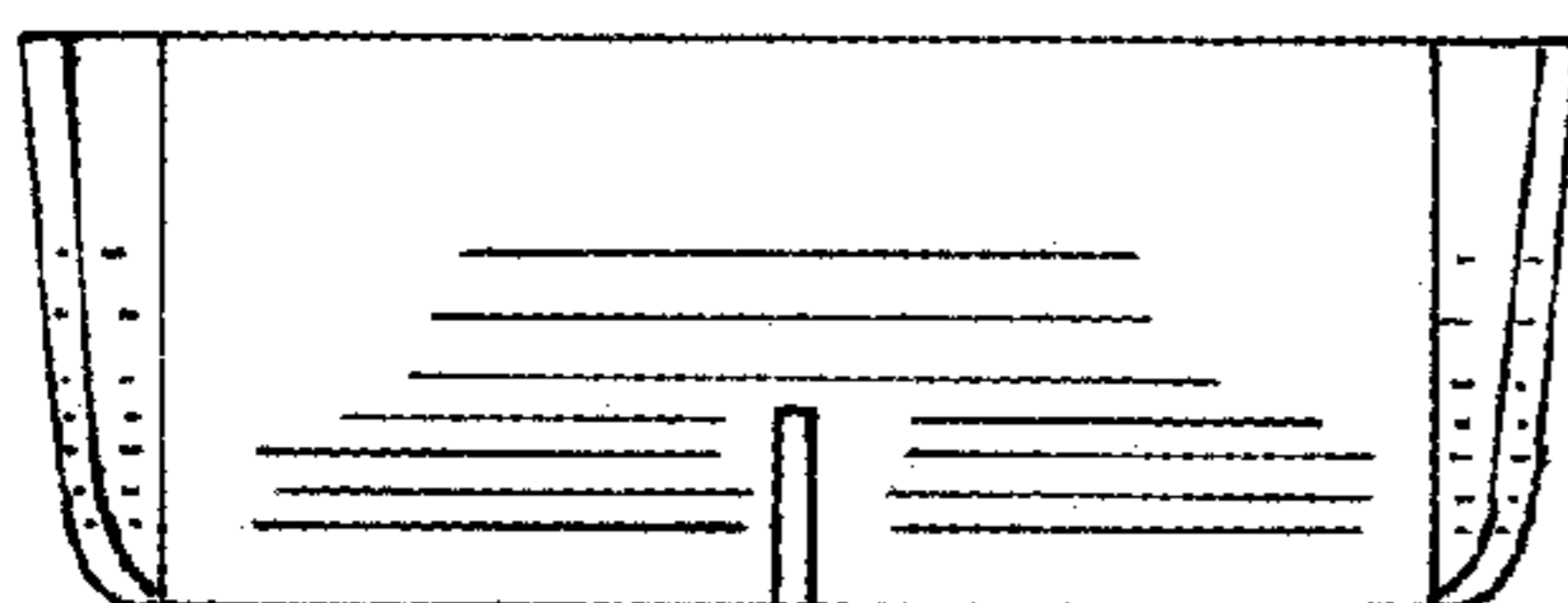

FIG. 5

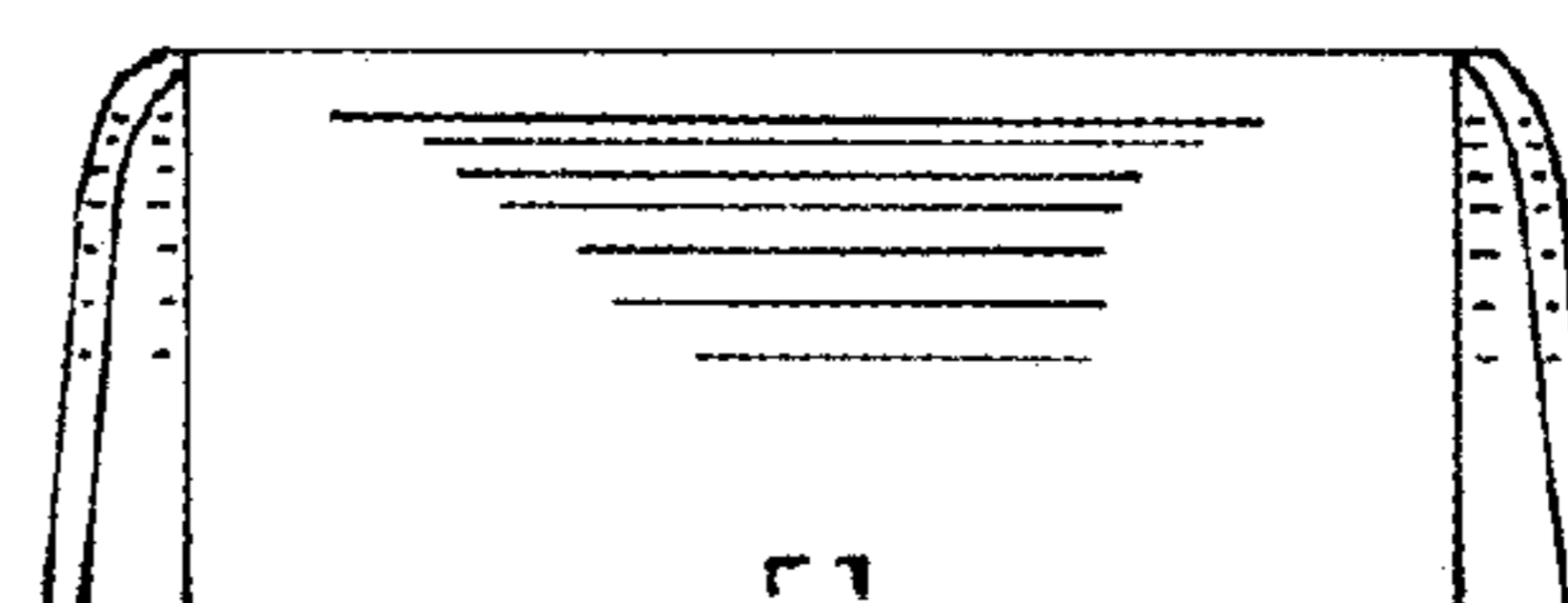

FIG. 6

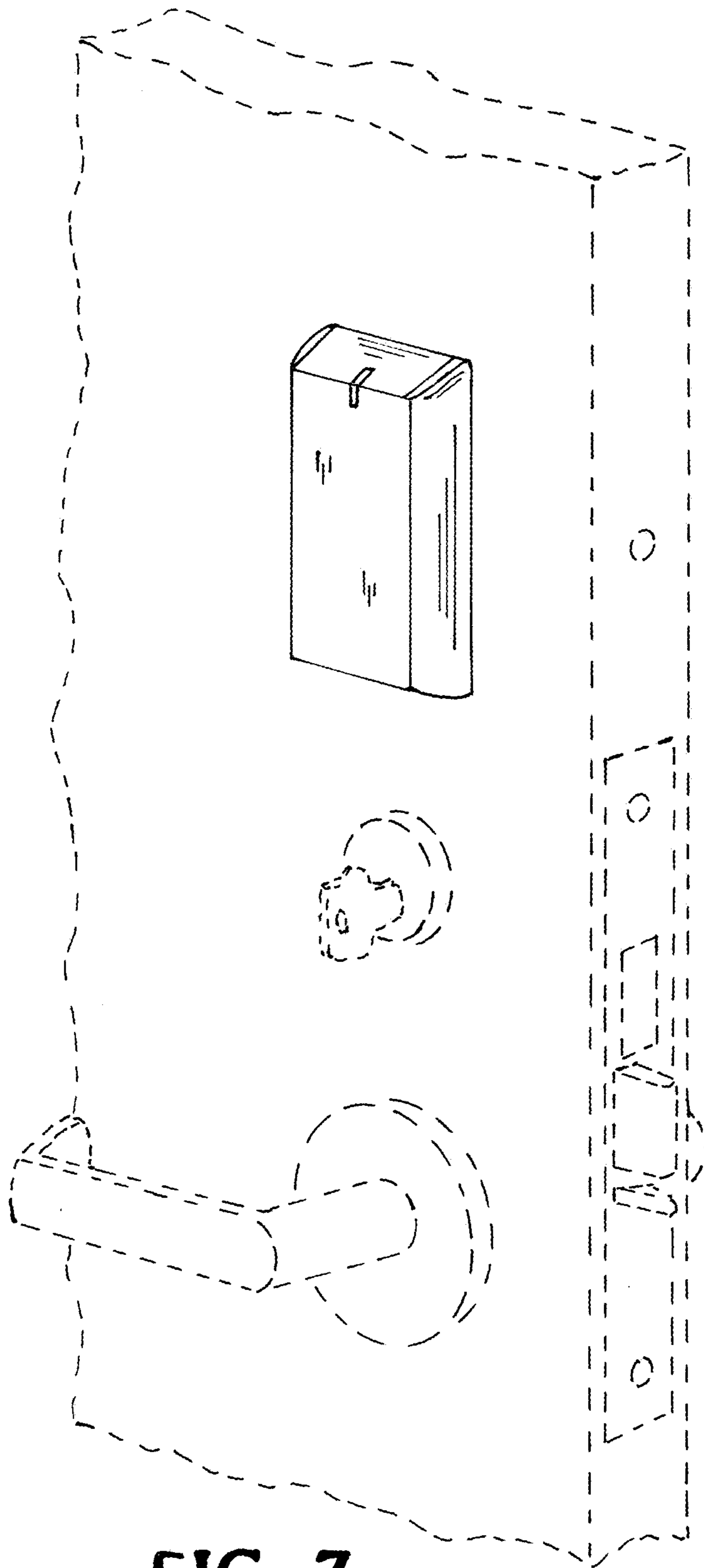

FIG. 7

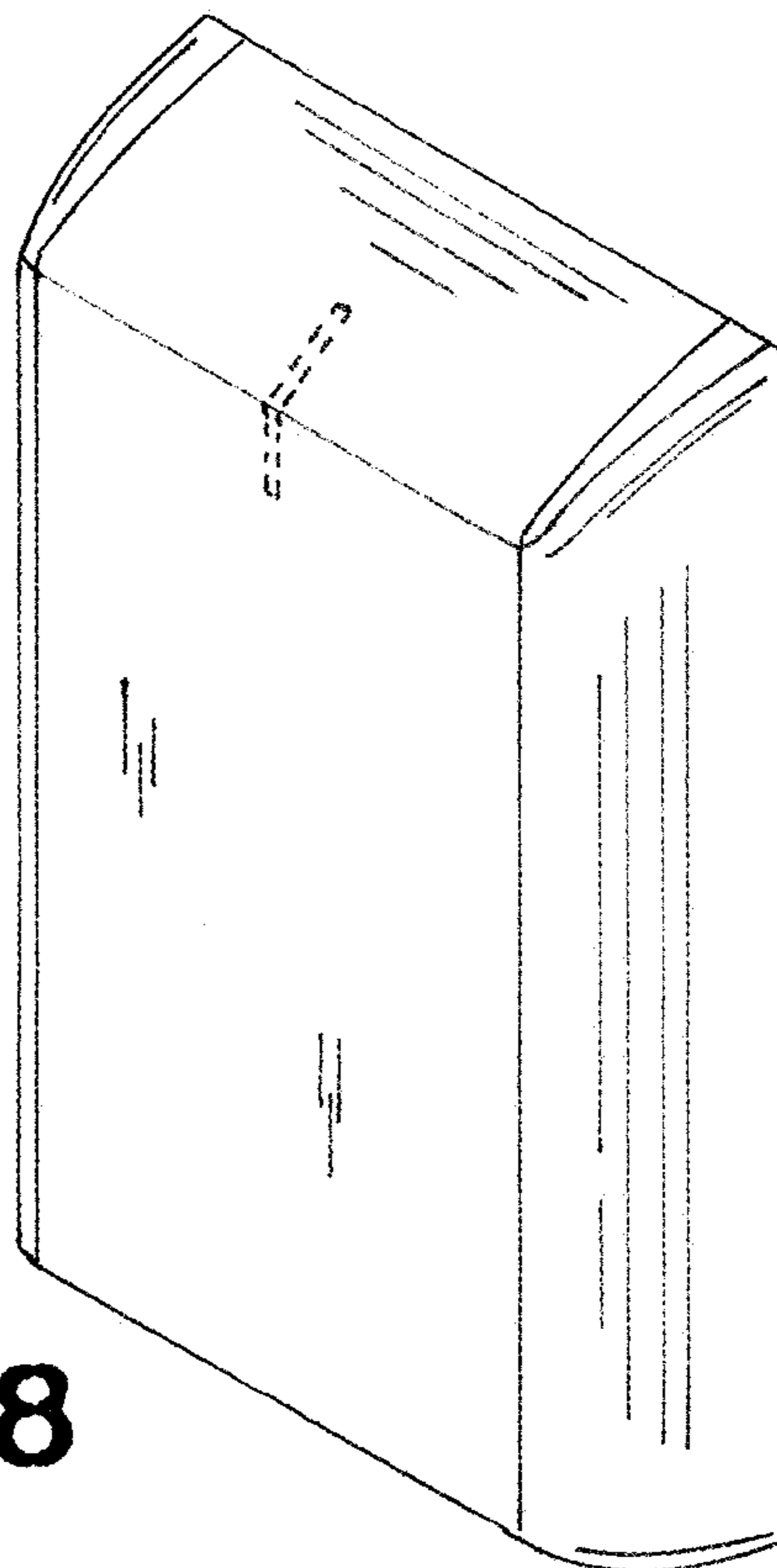

FIG. 8

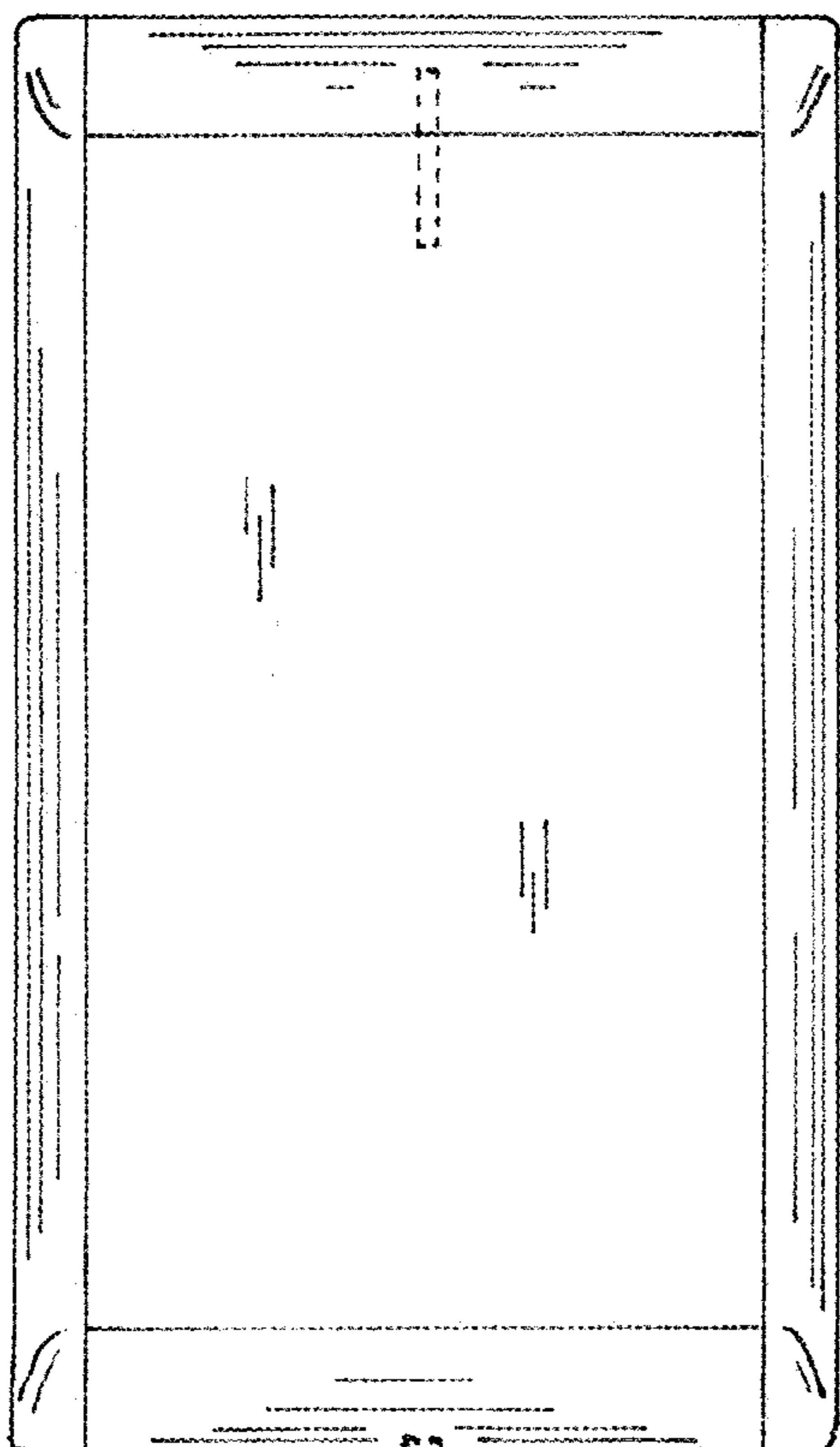

FIG. 9

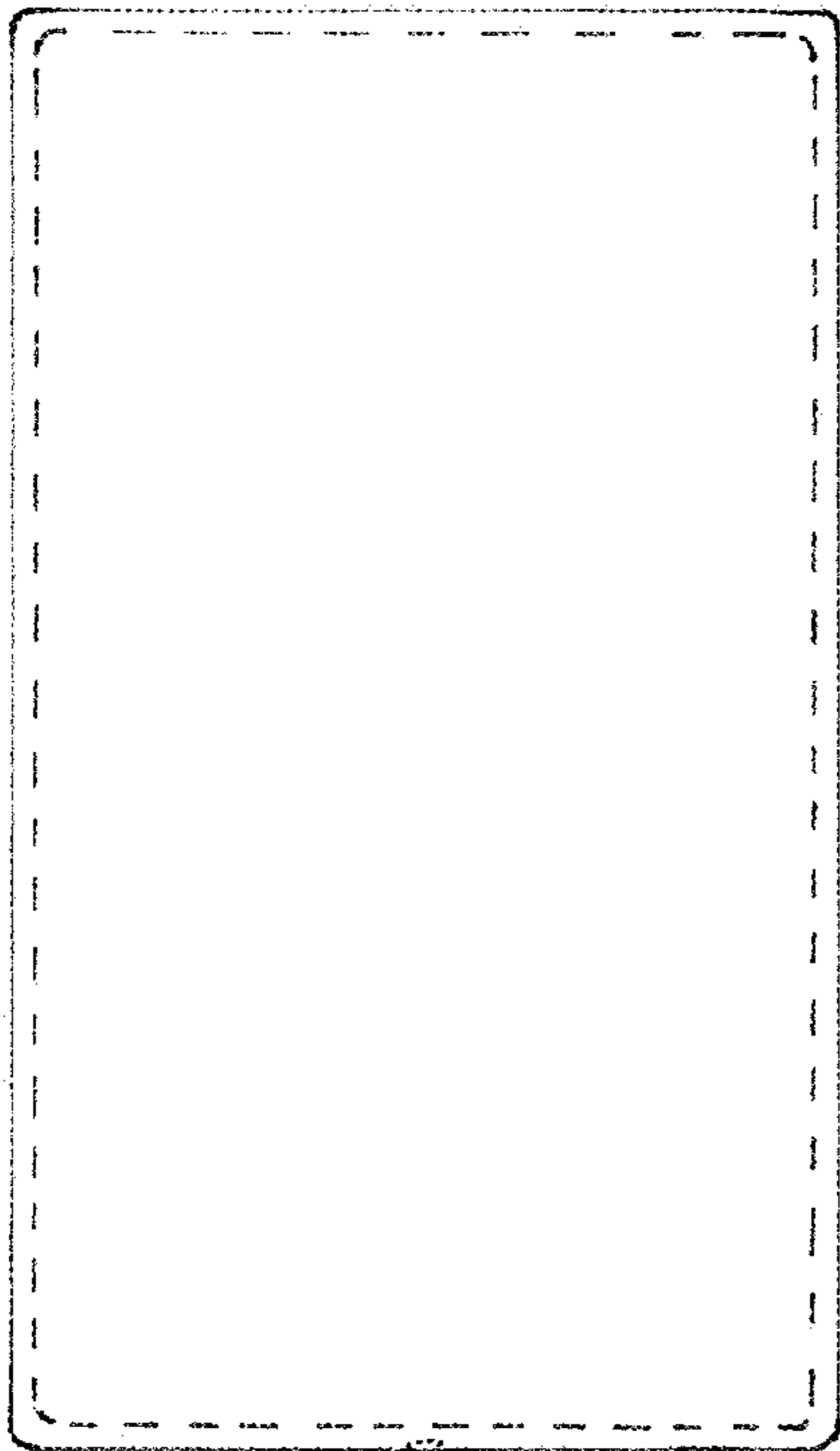

FIG. 10

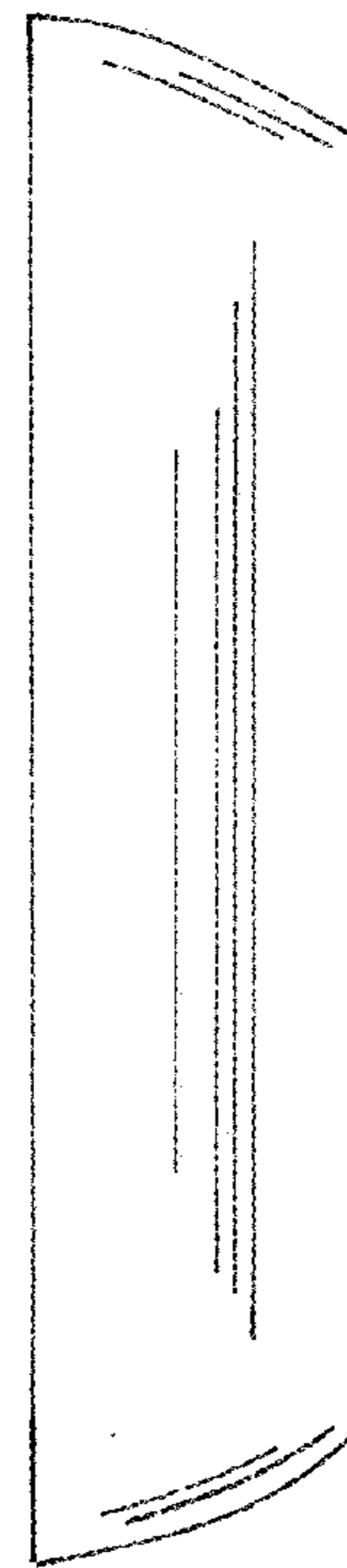

FIG. 11

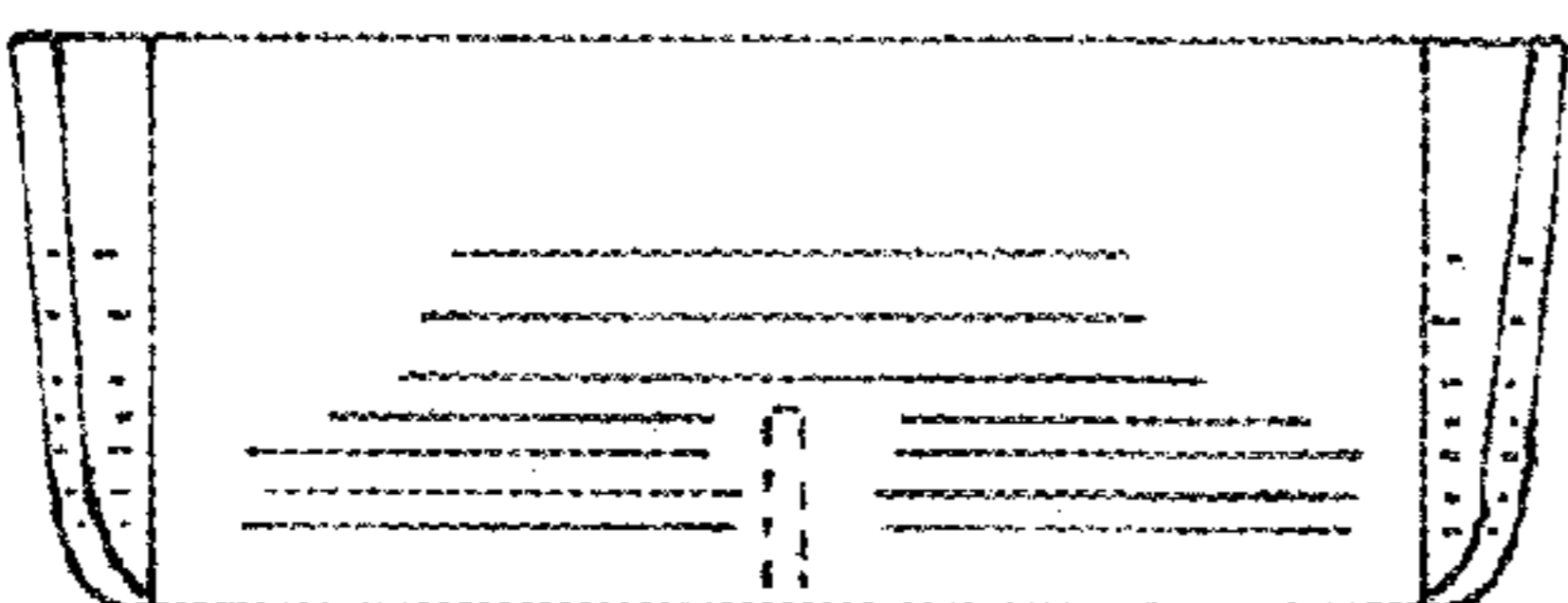

FIG. 12

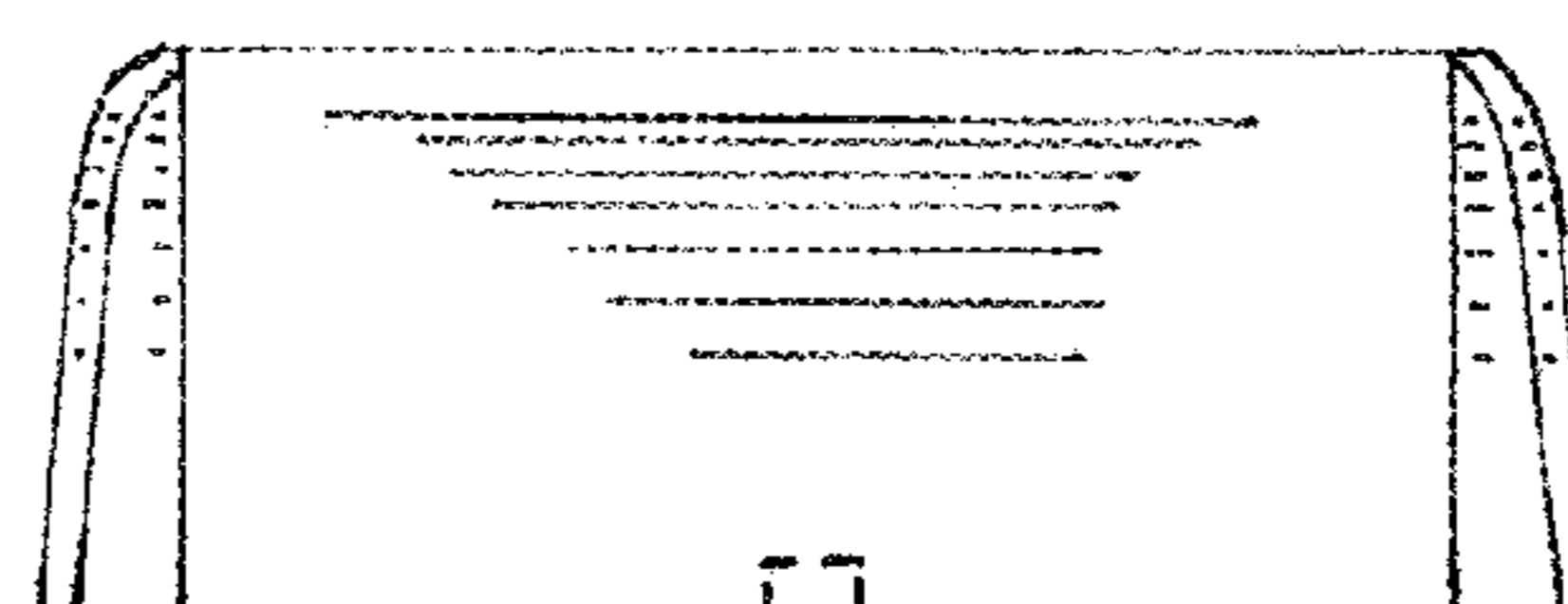

FIG. 13

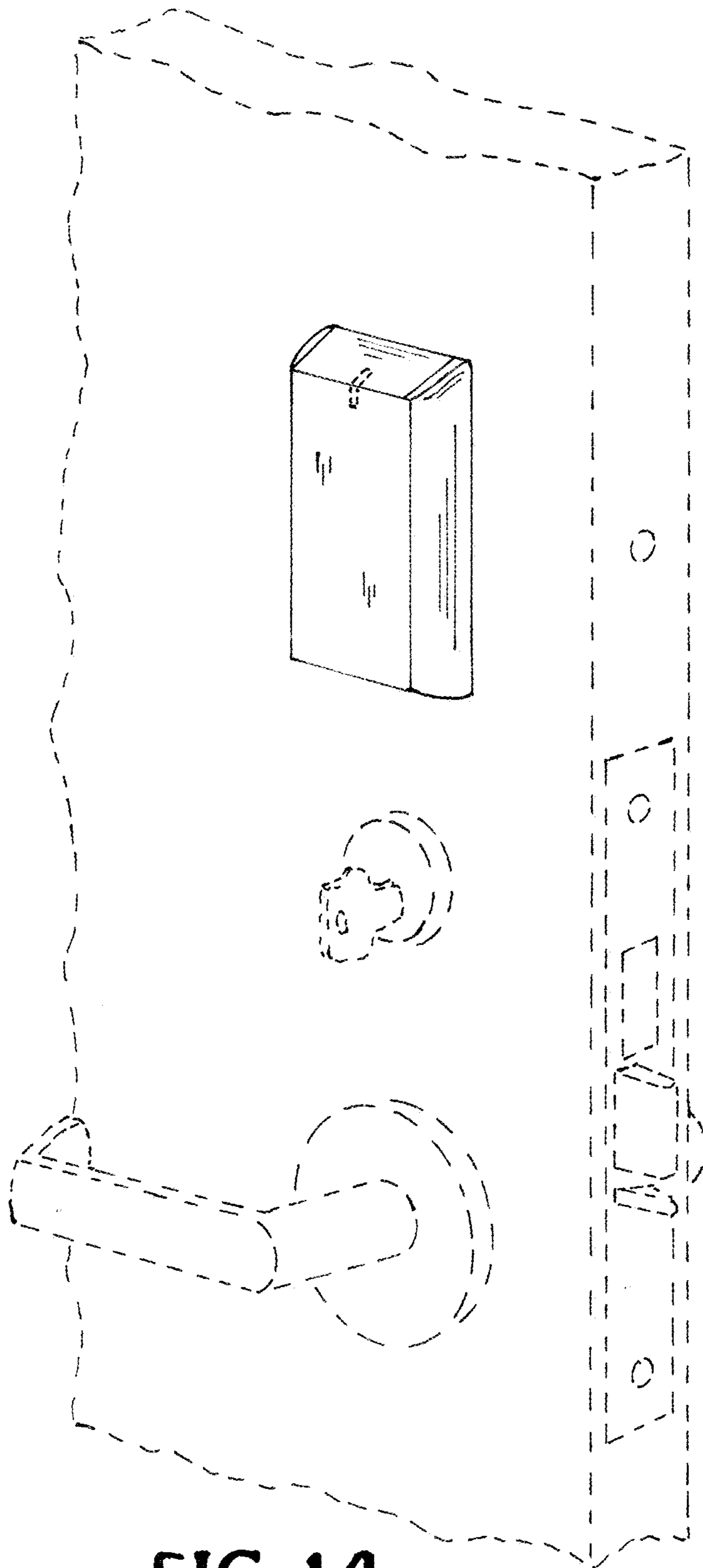

FIG. 14

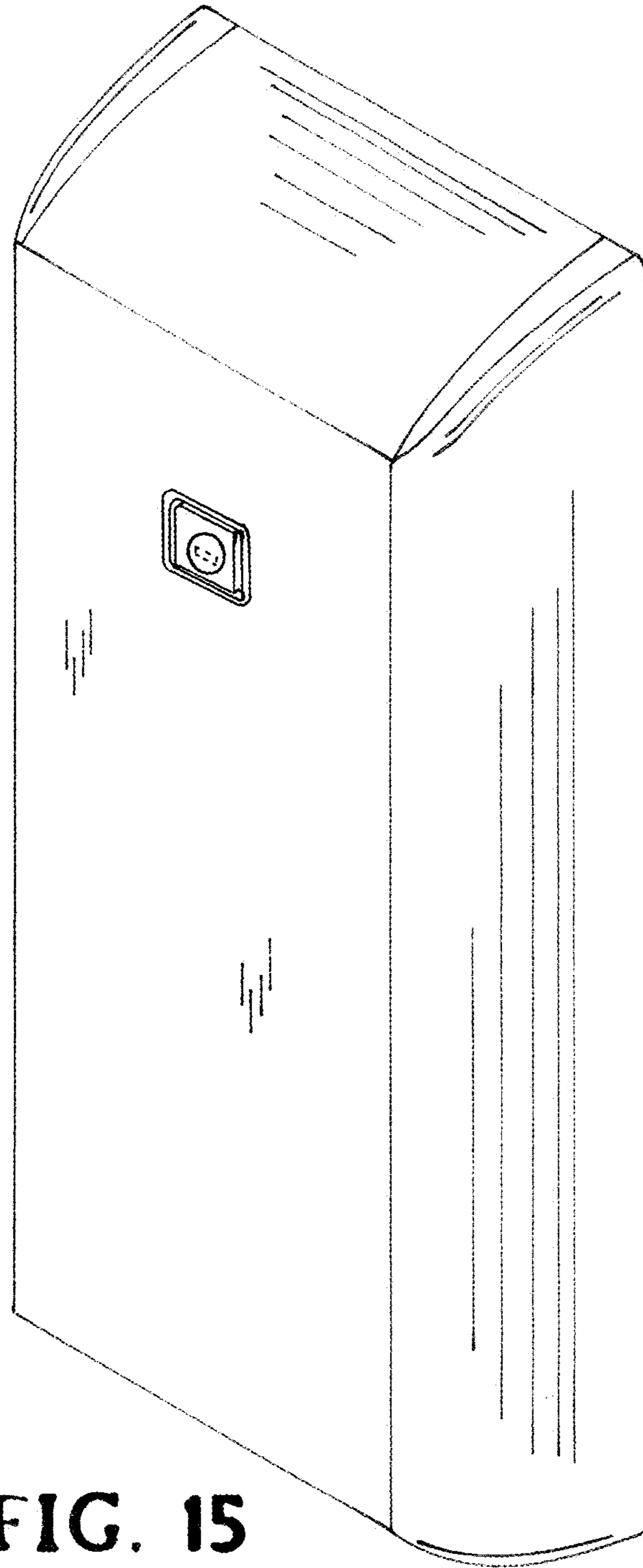

FIG. 15

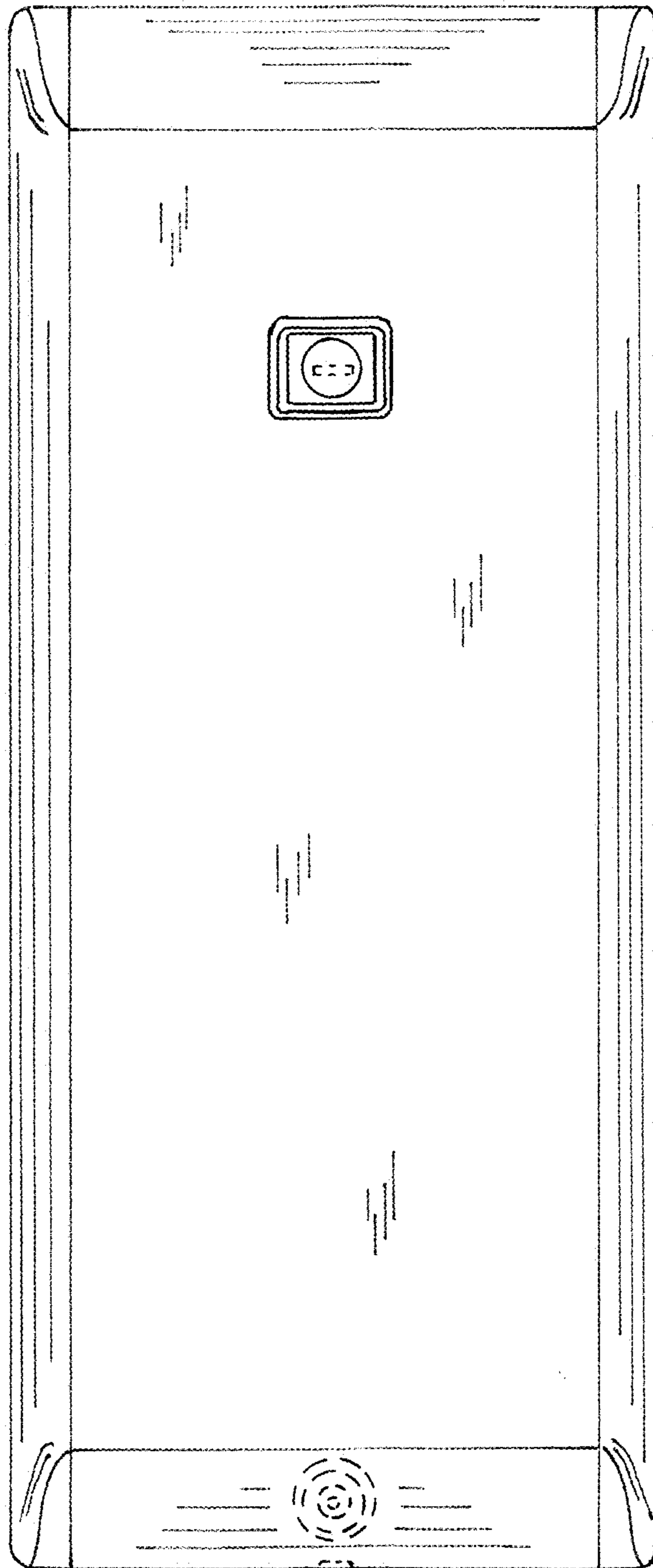

FIG. 16

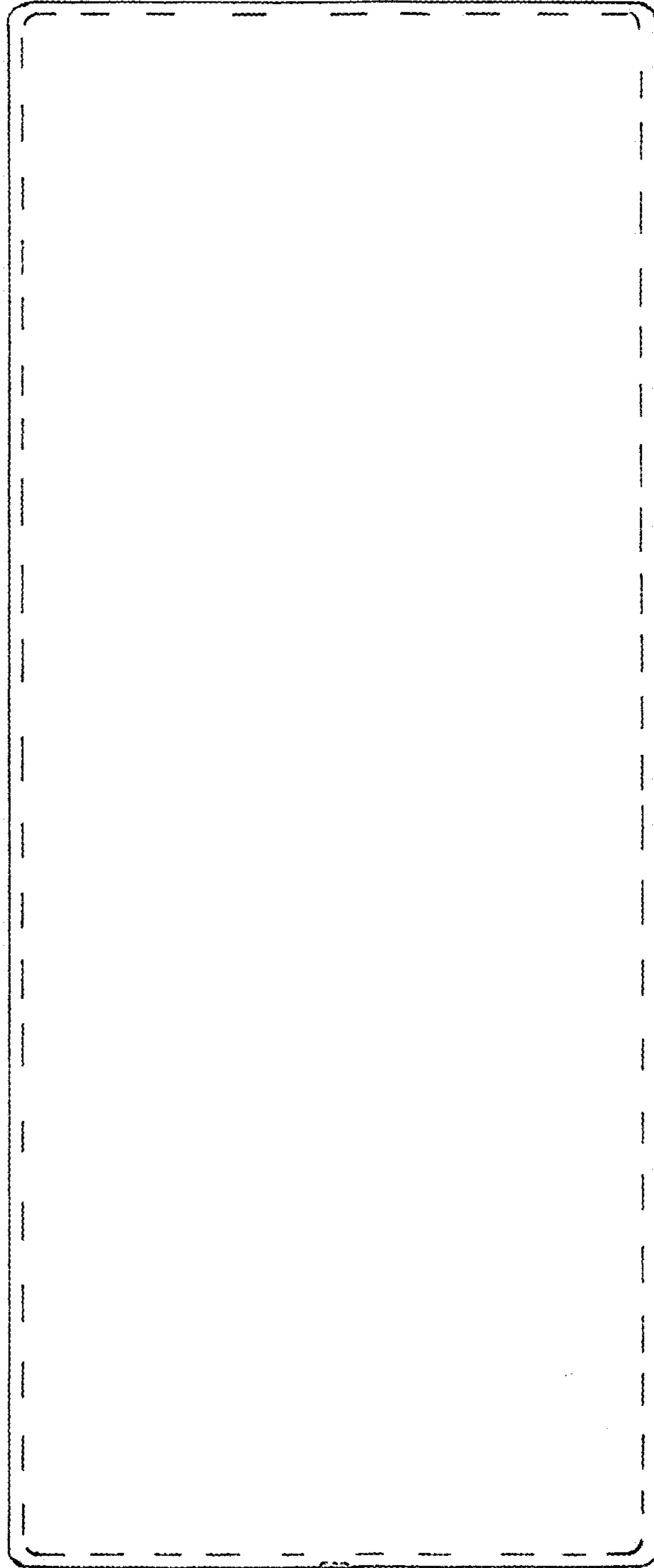

FIG. 17

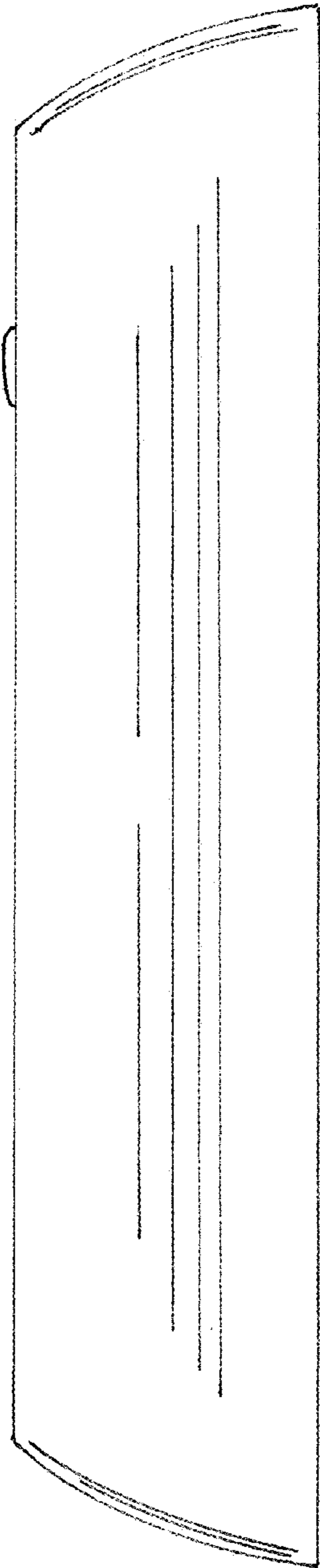

FIG. 18

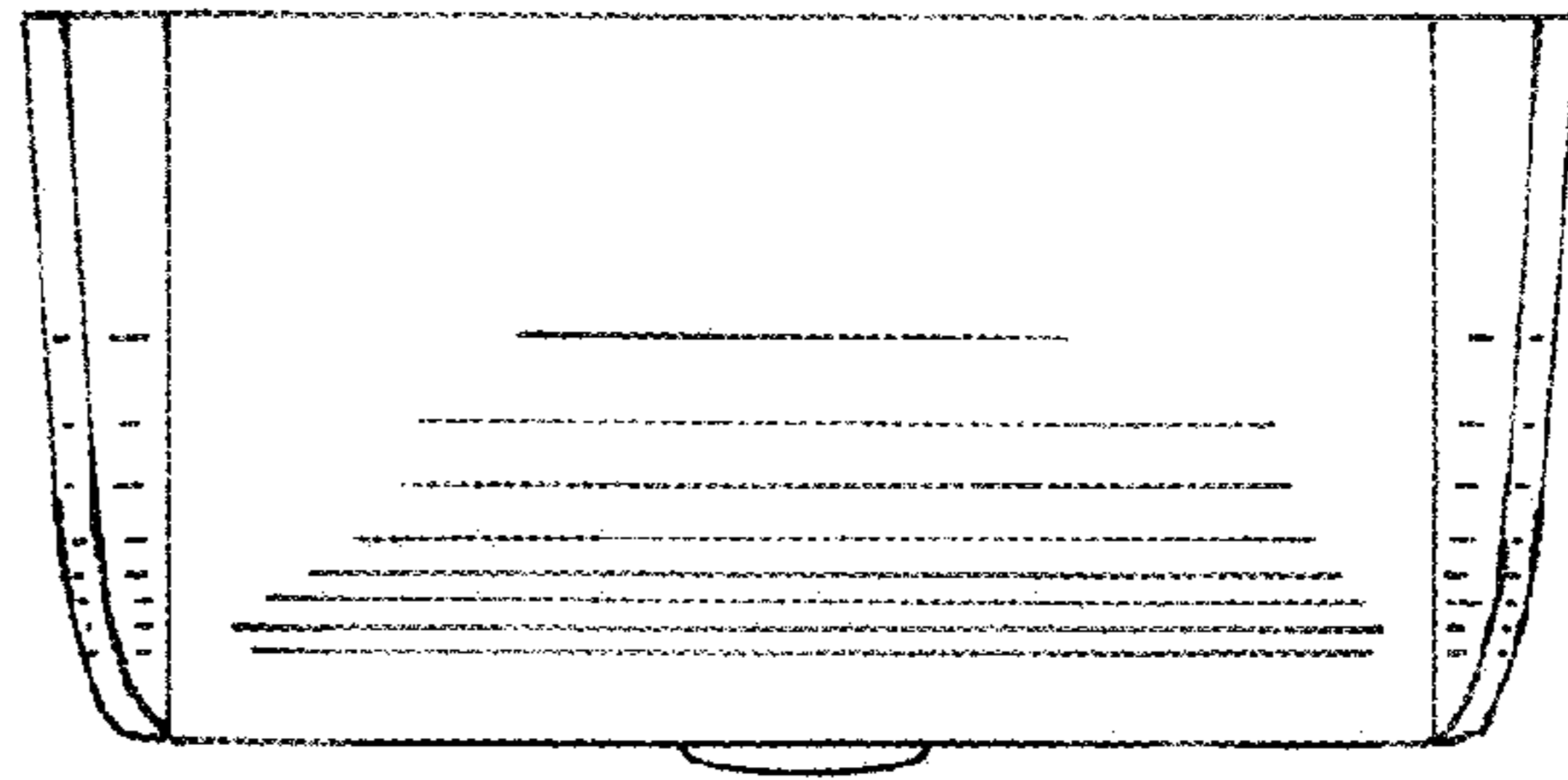

FIG. 19

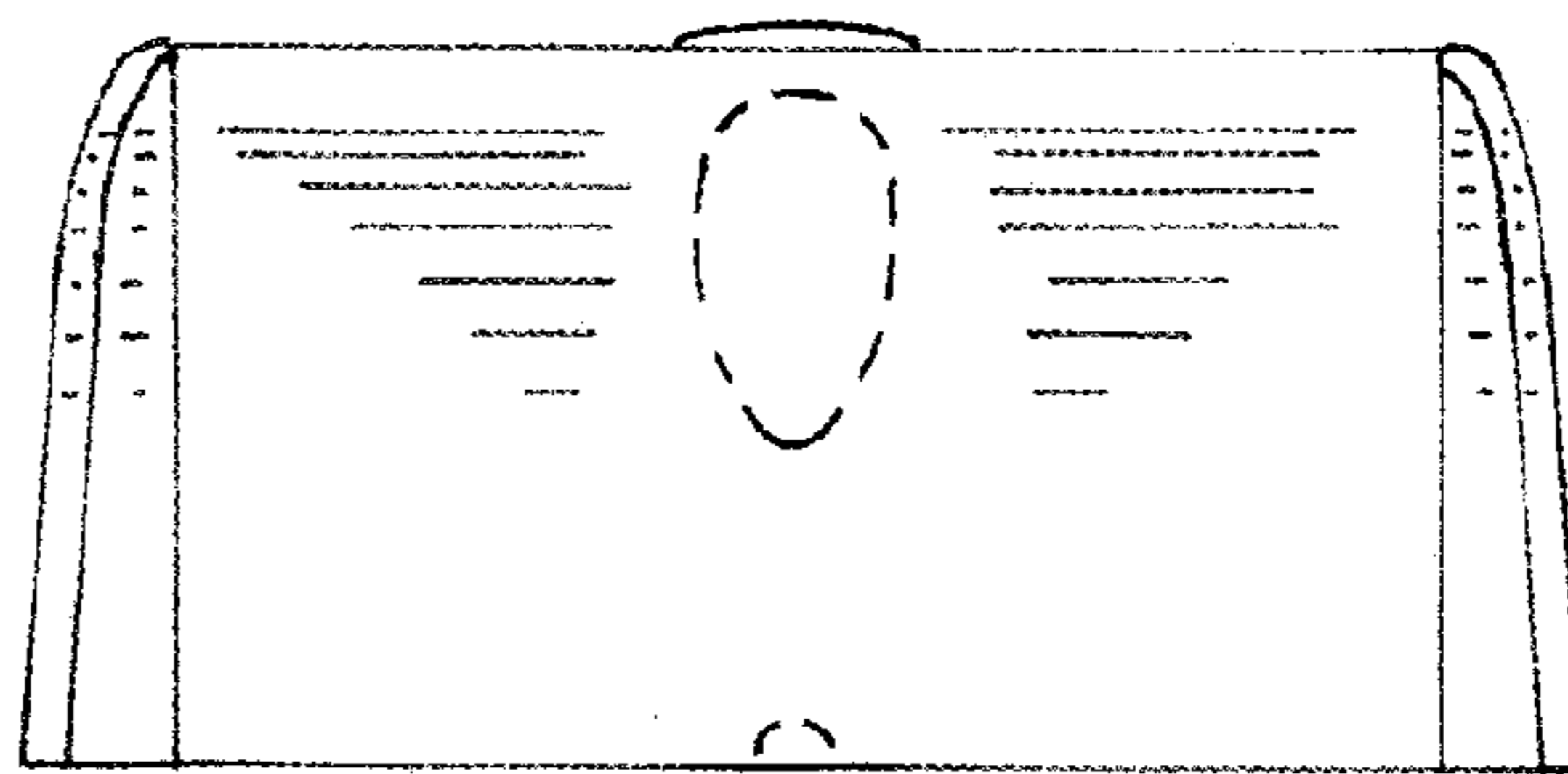

FIG. 20

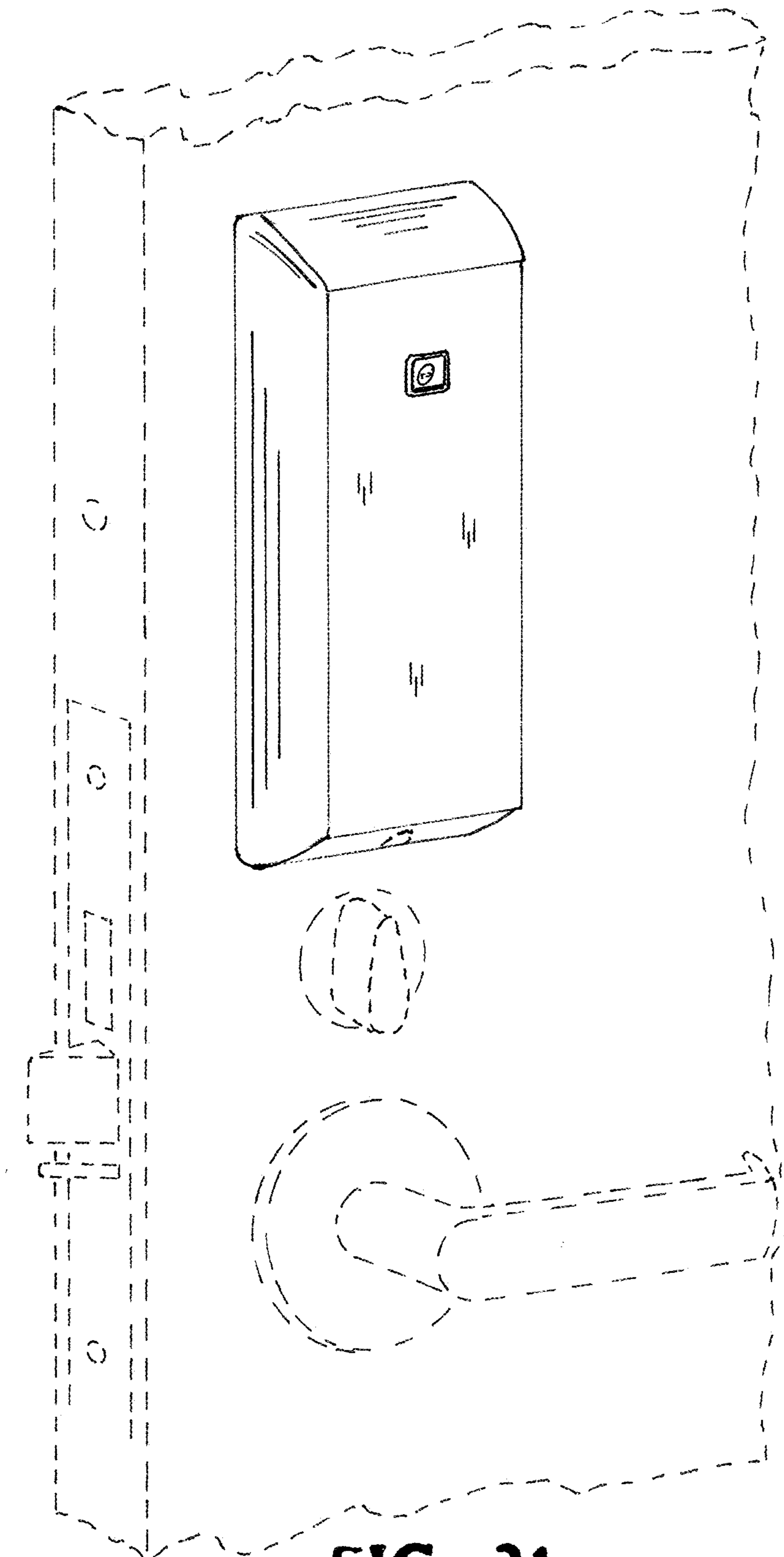

FIG. 21

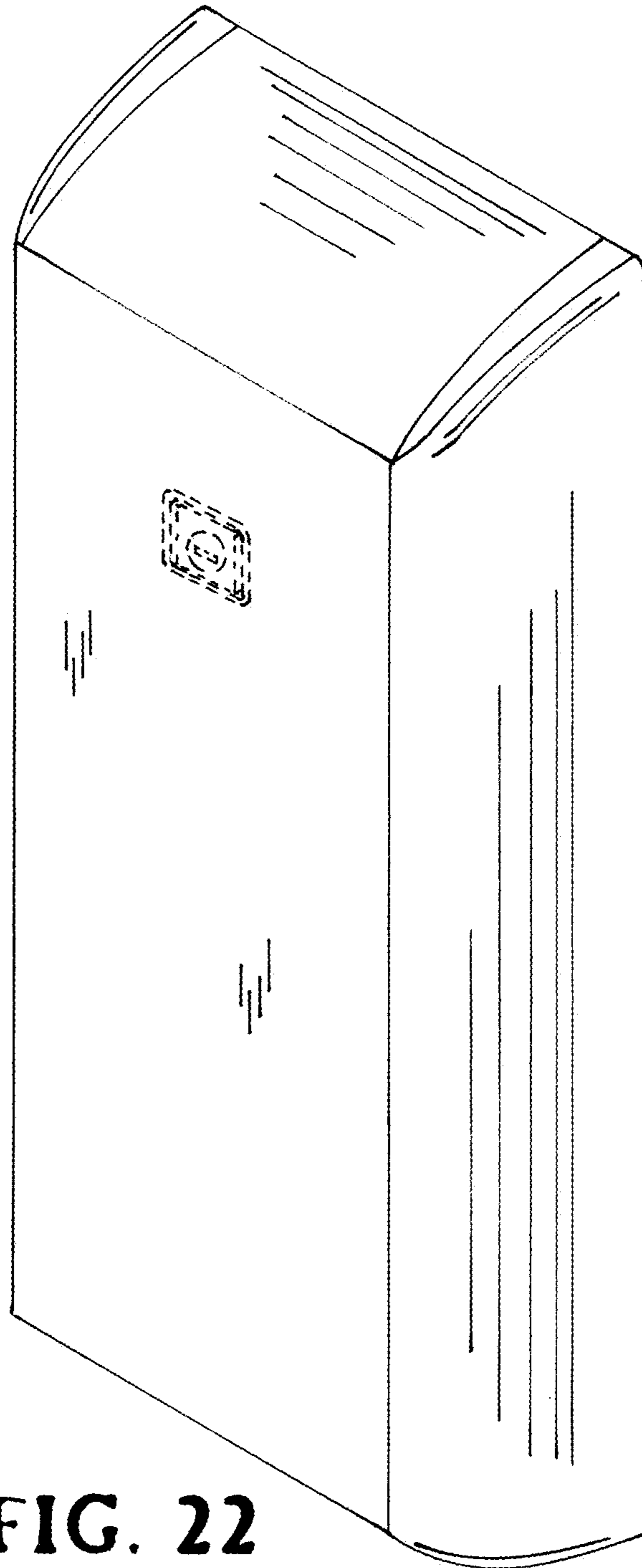

FIG. 22

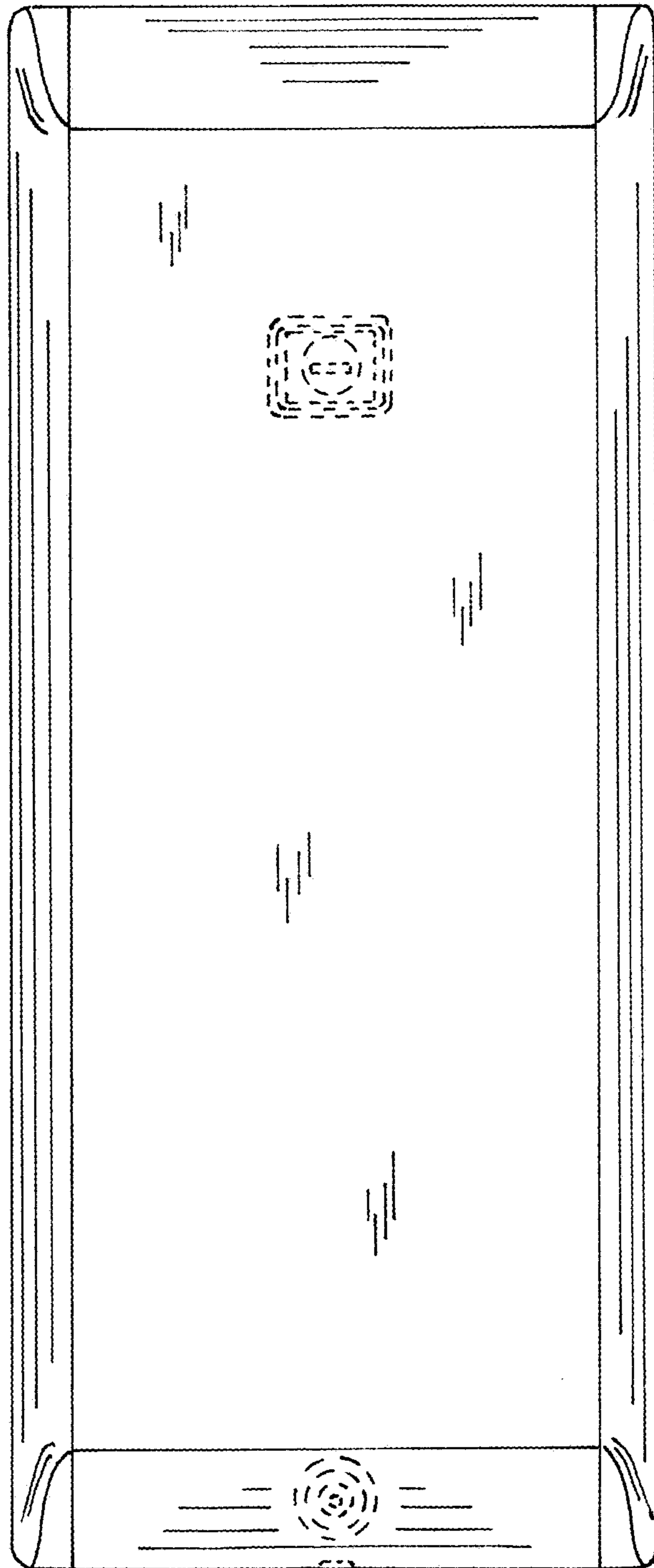

FIG. 23

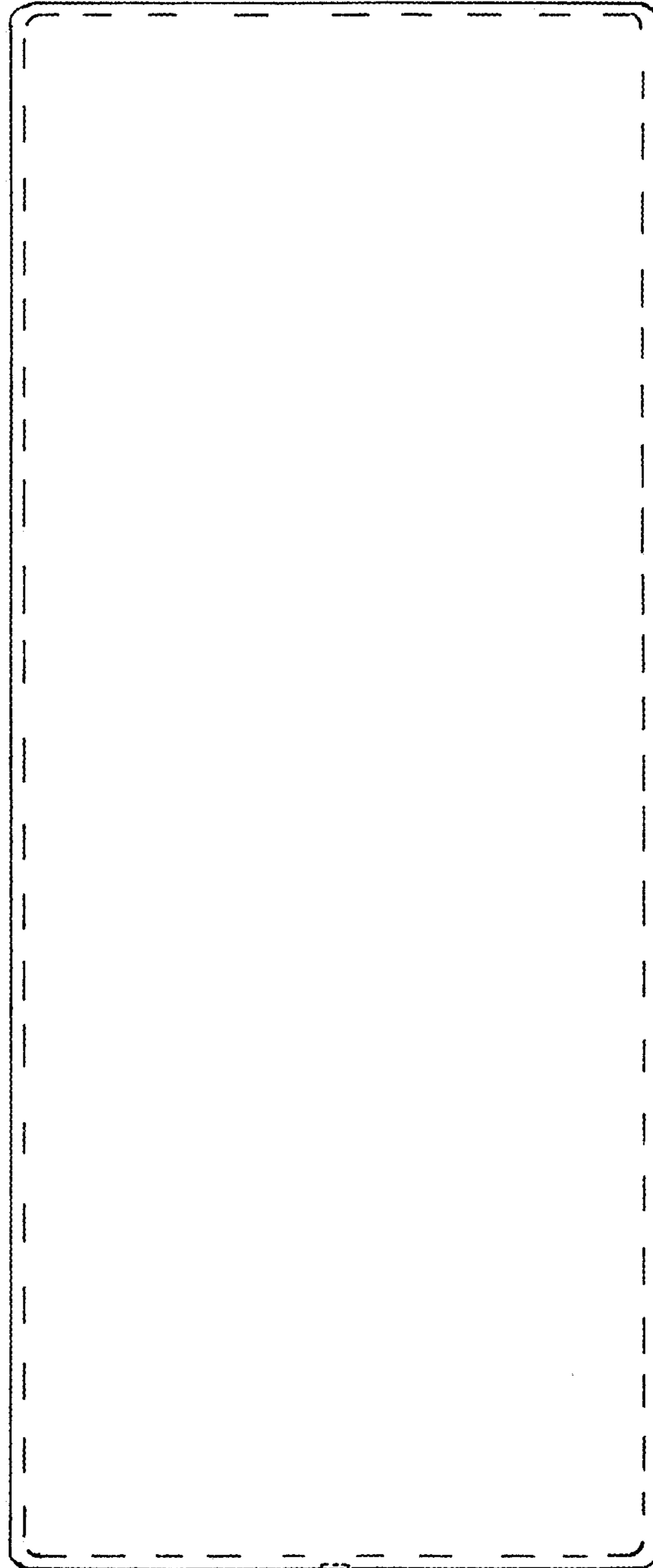

FIG. 24

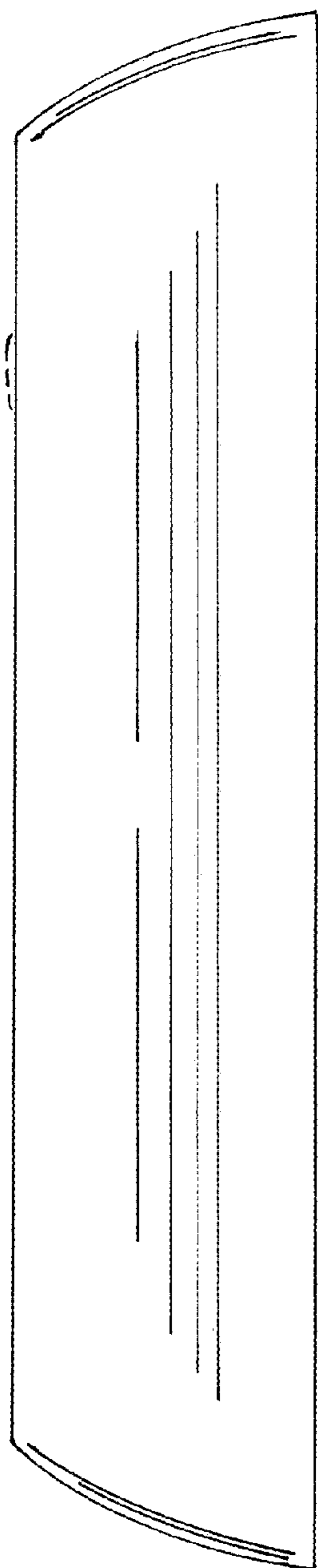

FIG. 25

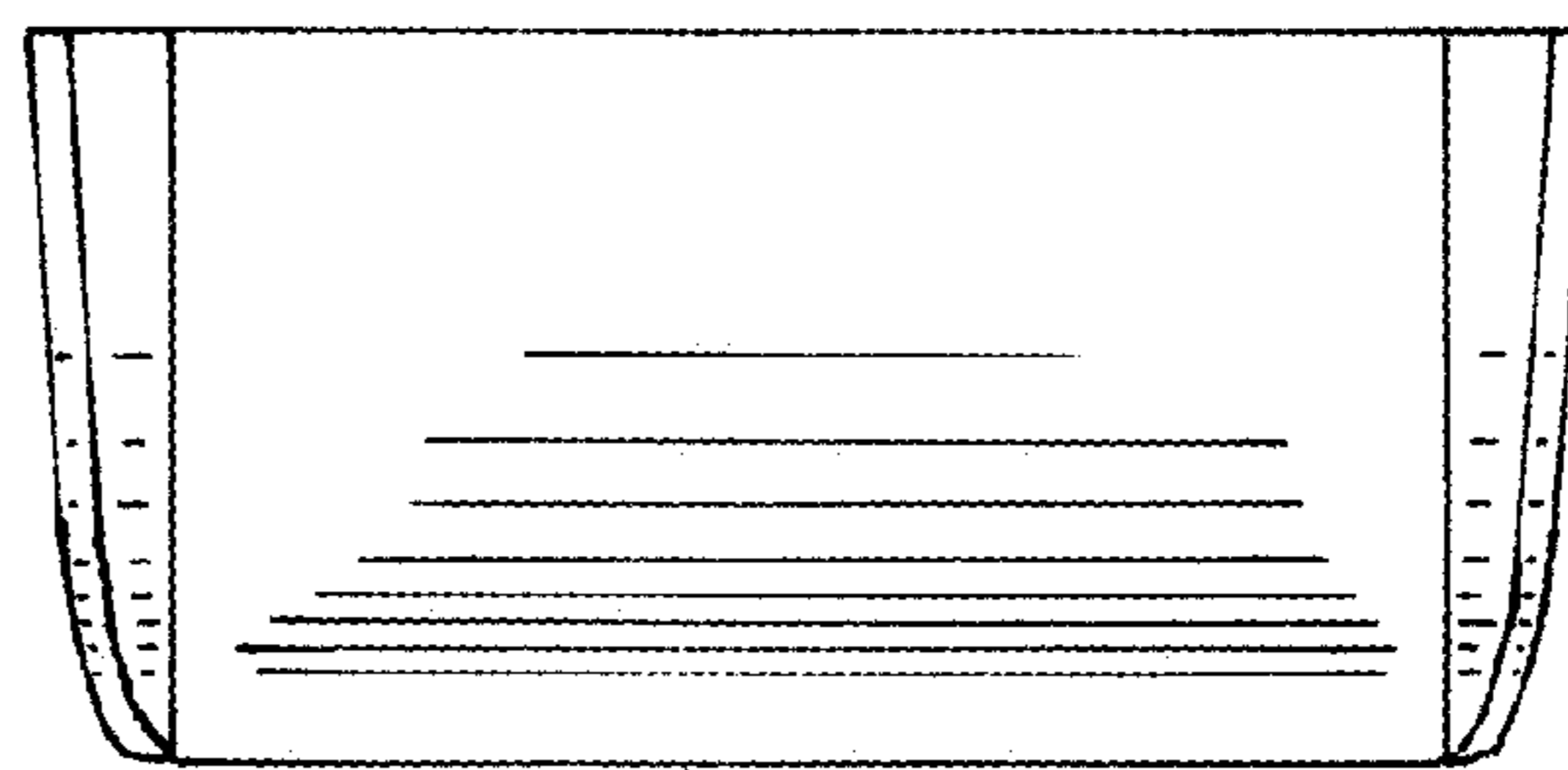

FIG. 26

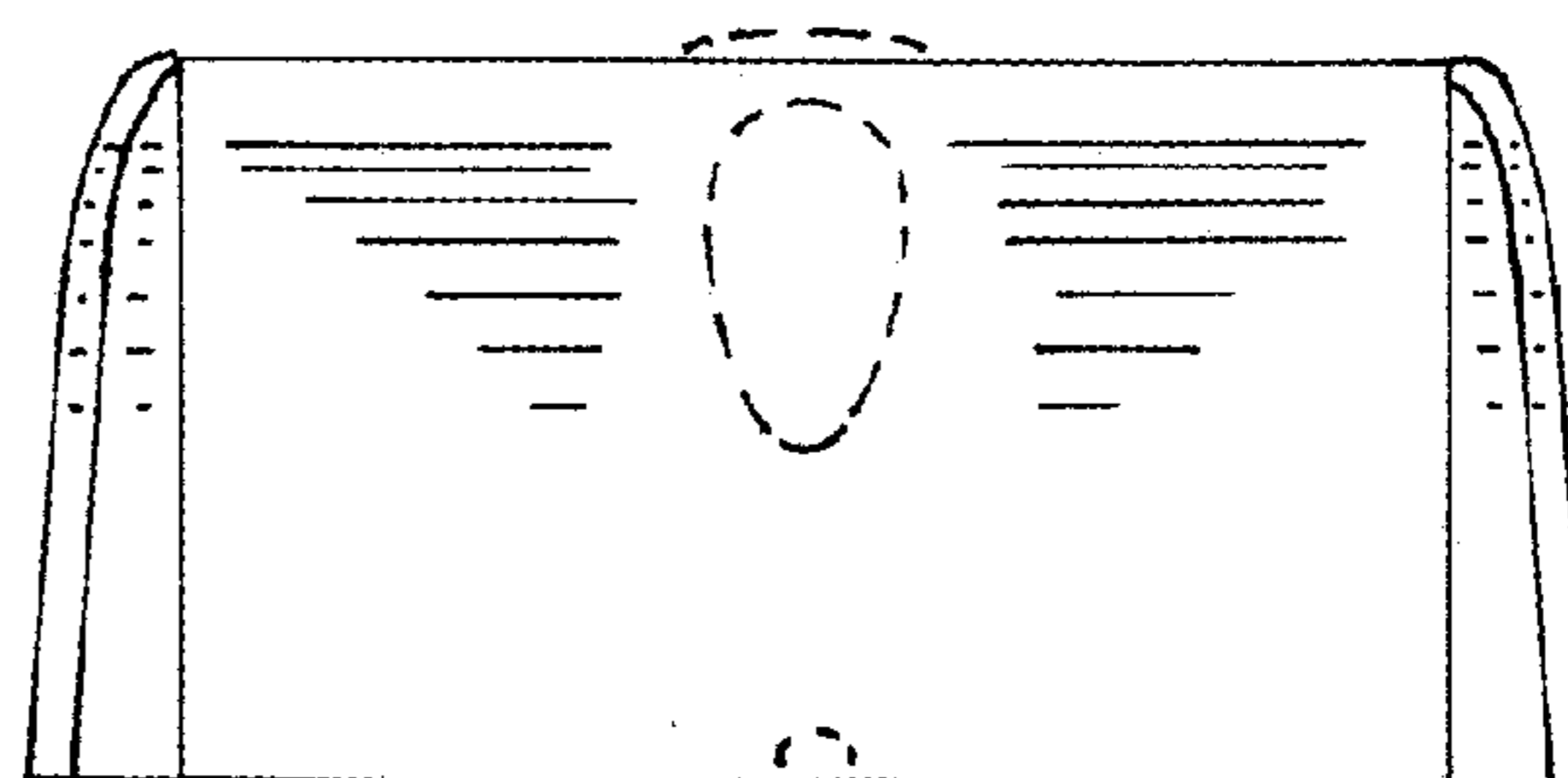

FIG. 27

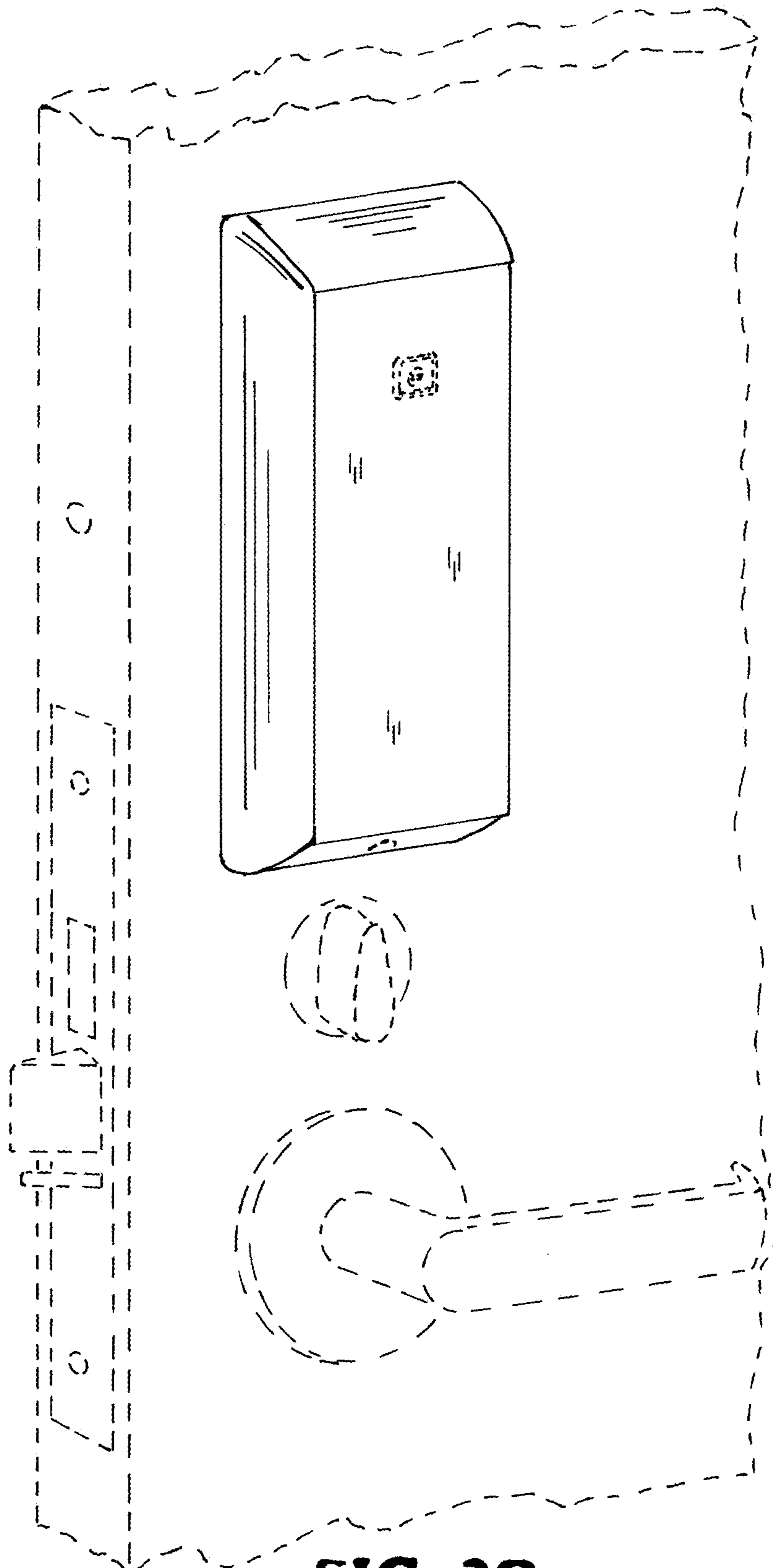

FIG. 28