



US00D738165S

(12) **United States Design Patent**  
**Liu**

(10) **Patent No.:** **US D738,165 S**  
(45) **Date of Patent:** **\*\* Sep. 8, 2015**

(54) **PAPER DISH**

(71) Applicant: **Wen-Chin Liu**, Taichung (TW)

(72) Inventor: **Wen-Chin Liu**, Taichung (TW)

(\*\*) Term: **14 Years**

(21) Appl. No.: **29/460,487**

(22) Filed: **Jul. 11, 2013**

(51) **LOC (10) Cl.** ..... **07-01**

(52) **U.S. Cl.**  
USPC ..... **D7/586**

(58) **Field of Classification Search**  
USPC ..... D7/500, 566, 505, 587, 586; D20/130;  
220/574; 206/519; 229/406  
CPC ..... A47G 21/00  
See application file for complete search history.

(56) **References Cited**

**U.S. PATENT DOCUMENTS**

3,684,633	A *	8/1972	Haase	.....	428/66.7
5,088,640	A *	2/1992	Littlejohn	.....	229/406
D327,394	S *	6/1992	Scherer	.....	D7/584
5,758,773	A *	6/1998	Clements	.....	206/519
6,571,980	B2 *	6/2003	Littlejohn et al.	.....	220/574
D509,106	S *	9/2005	de Groote et al.	.....	D7/587

D593,364	S *	6/2009	Harris	.....	D7/505
D646,122	S *	10/2011	Burns	.....	D7/505
D656,790	S *	4/2012	Clarichetti et al.	.....	D7/566
D659,913	S *	5/2012	Spectre et al.	.....	D30/130
8,414,464	B2 *	4/2013	Grischenko et al.	.....	493/167
D711,191	S *	8/2014	Lee	.....	D7/409

\* cited by examiner

*Primary Examiner* — Cynthia Underwood

(74) *Attorney, Agent, or Firm* — C. G. Mersereau; Nikolai & Mersereau, P.A.

(57) **CLAIM**

The ornamental design for a paper dish, as shown and described.

**DESCRIPTION**

FIG. 1 is a perspective view of a paper dish, showing my new design;  
FIG. 2 is a front view thereof;  
FIG. 3 is a rear view thereof;  
FIG. 4 is a left-side view thereof;  
FIG. 5 is a right-side view thereof;  
FIG. 6 is a top view thereof;  
FIG. 7 is a bottom view thereof; and,  
FIG. 8 is an enlarged cross sectional side view thereof along line 8-8 in FIG. 2.

**1 Claim, 8 Drawing Sheets**

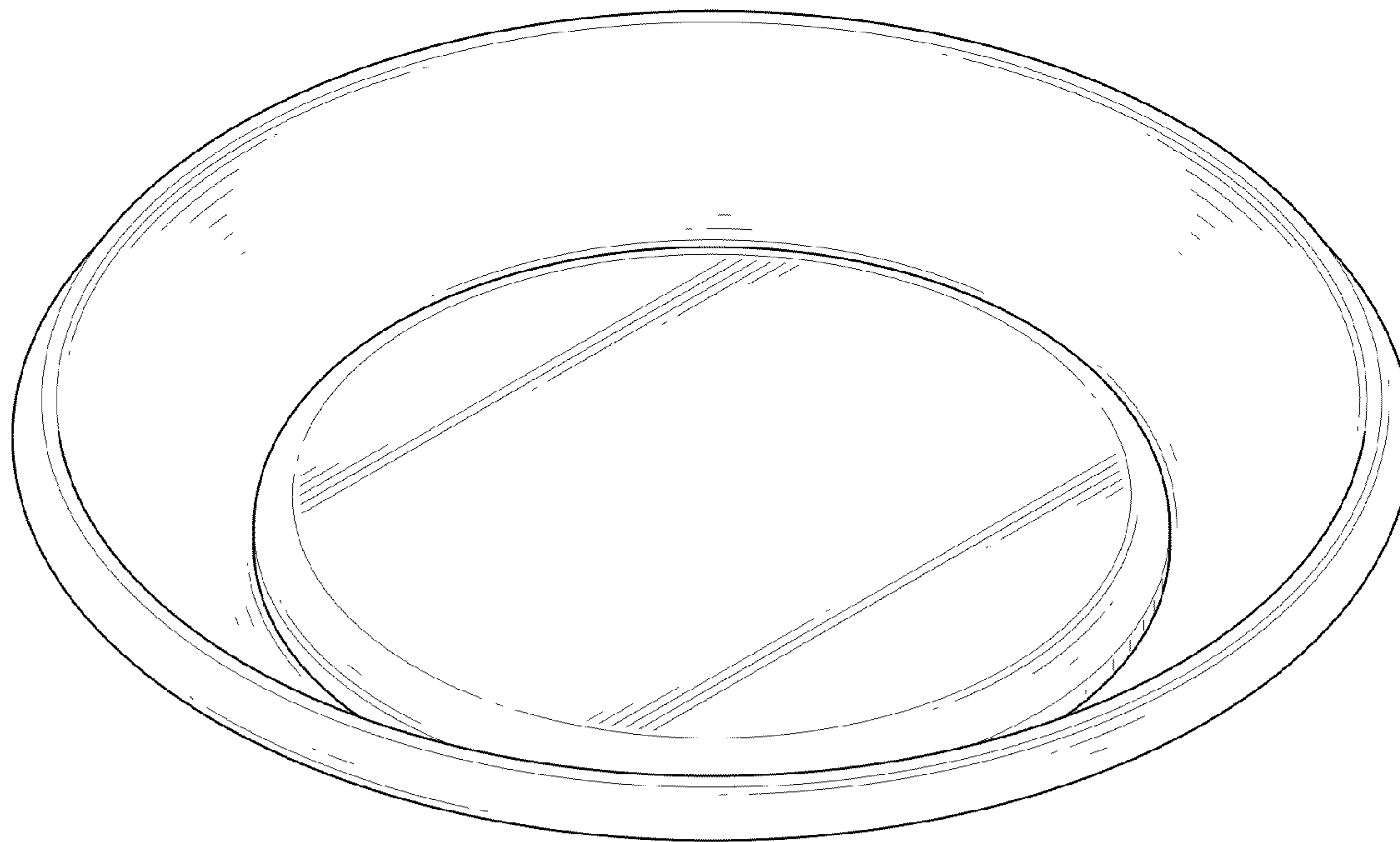

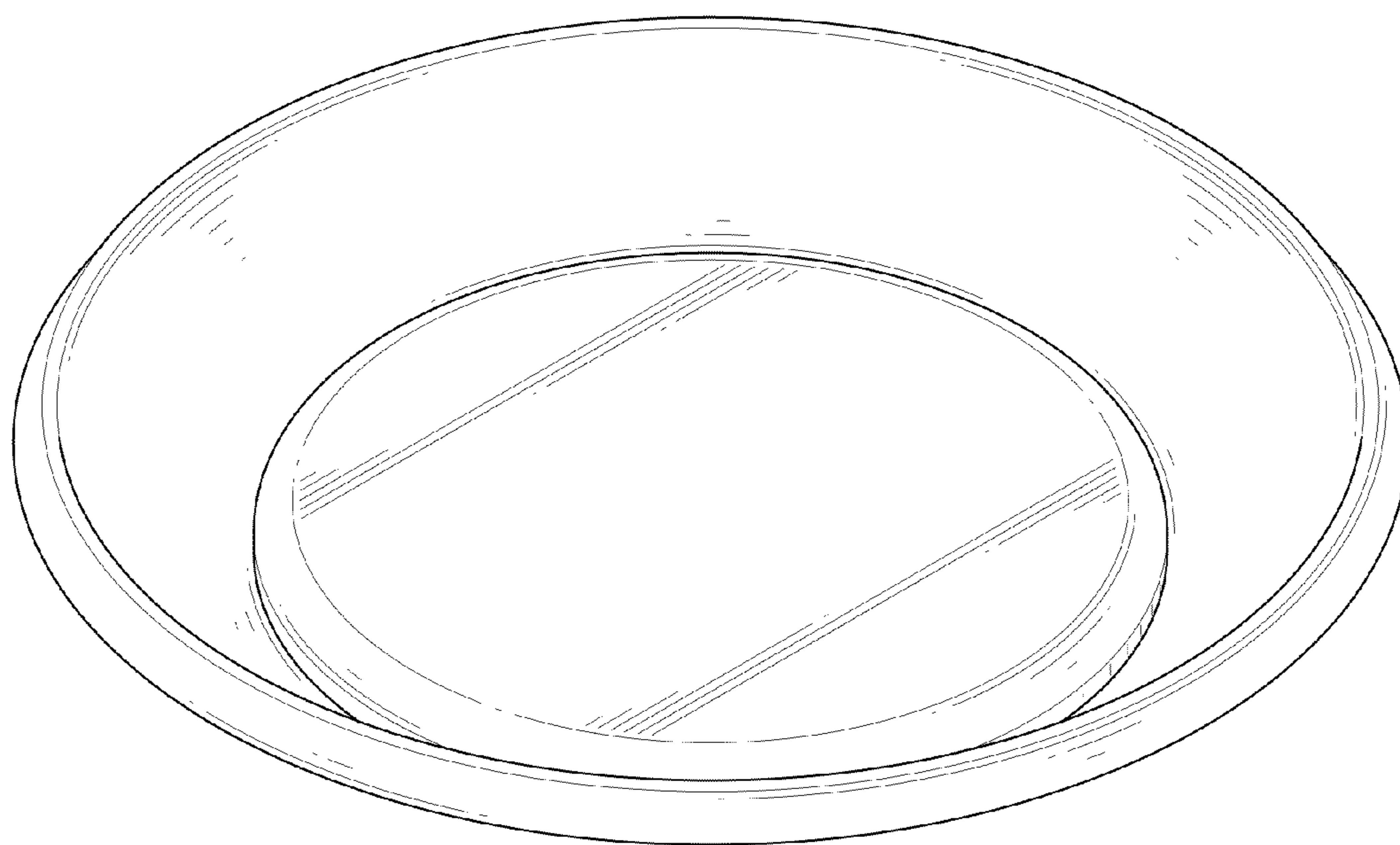

FIG.1

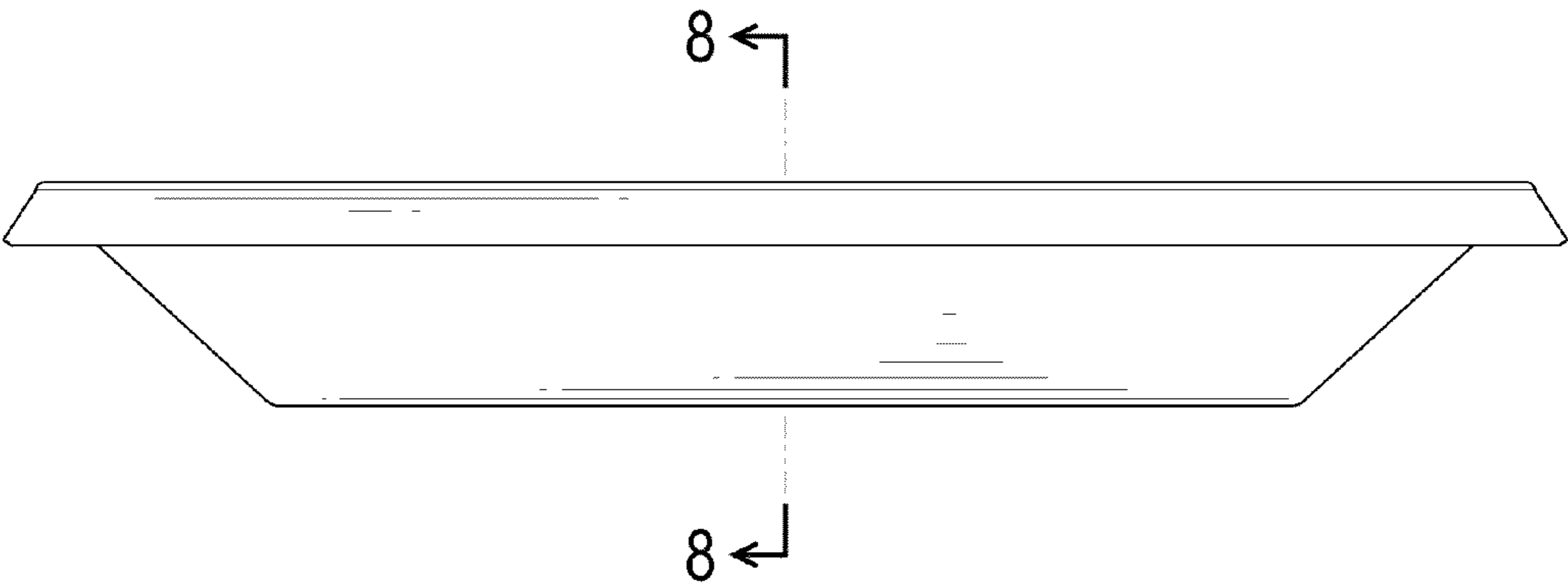

FIG.2

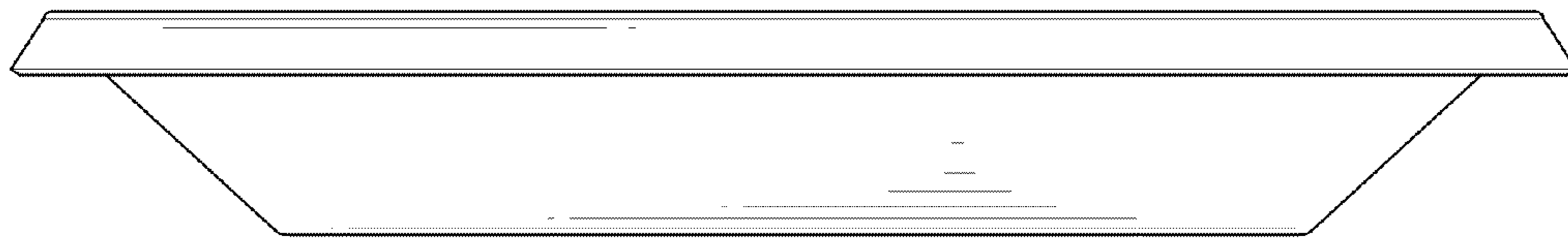

FIG.3

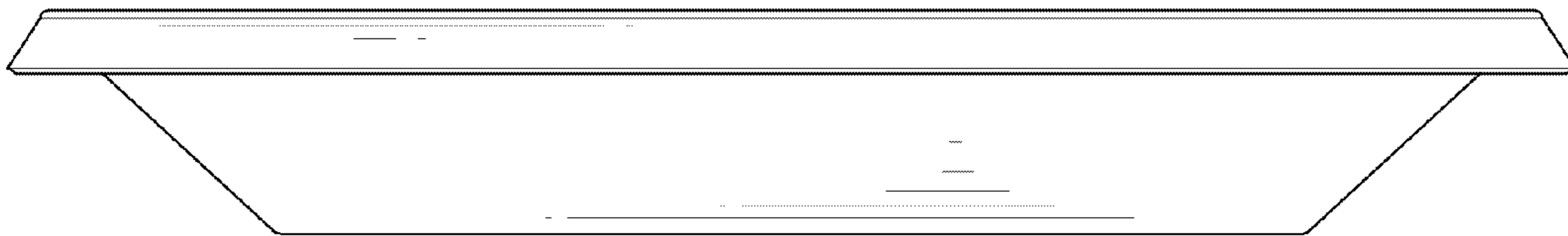

FIG.4

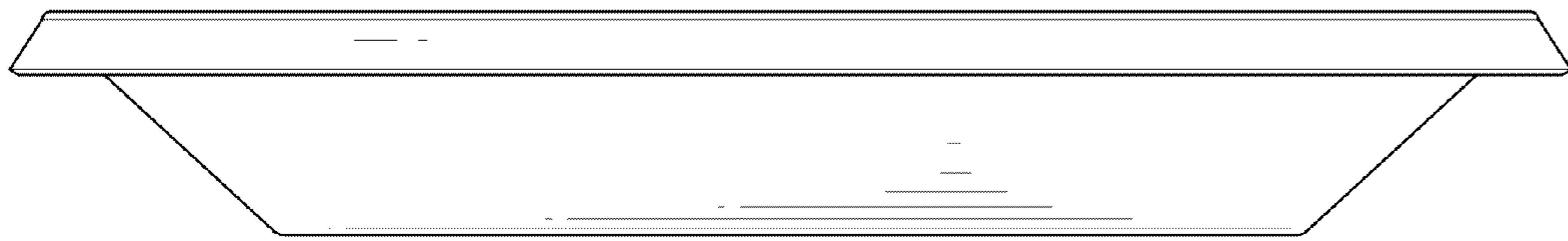

FIG.5

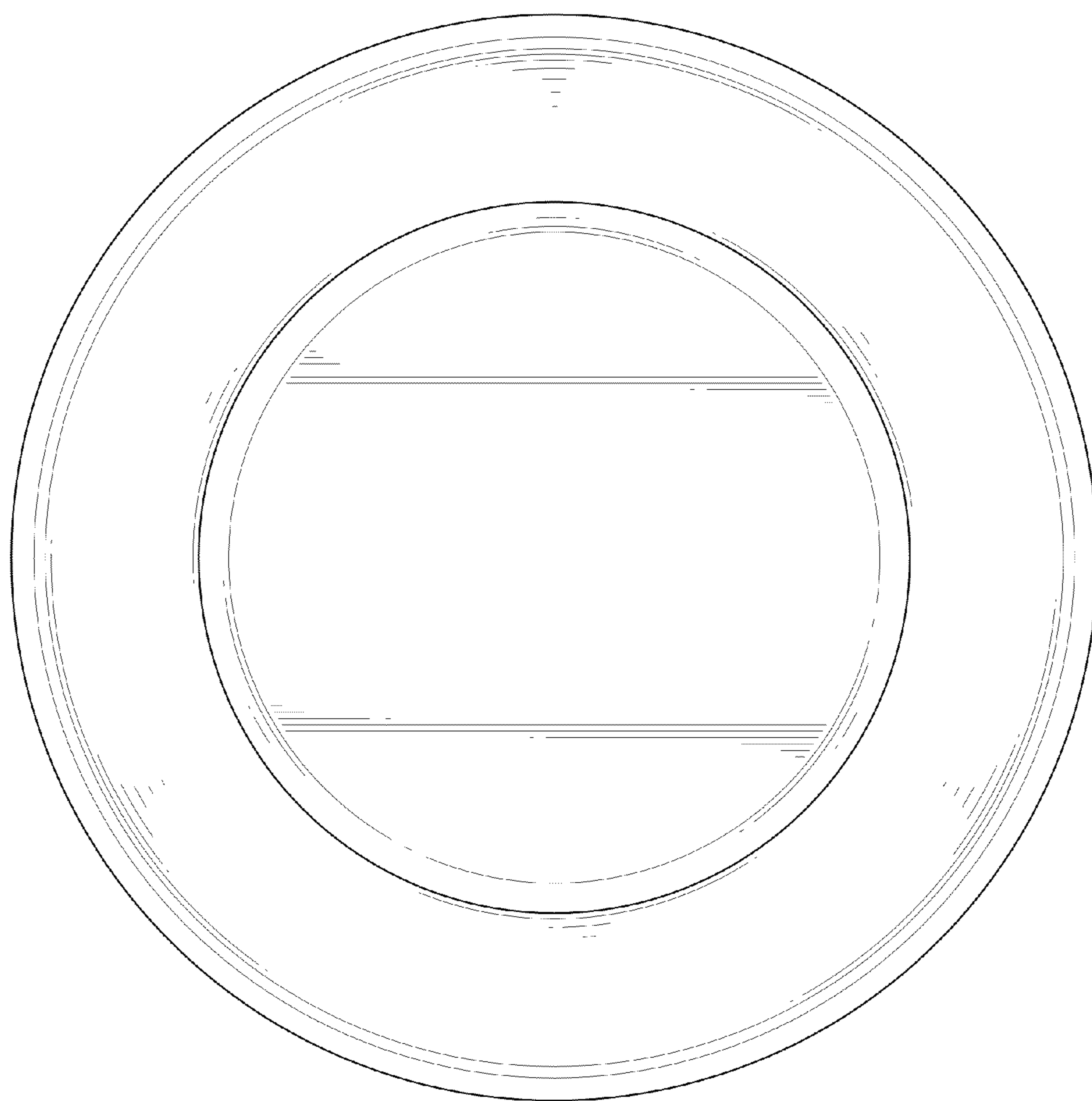

FIG.6

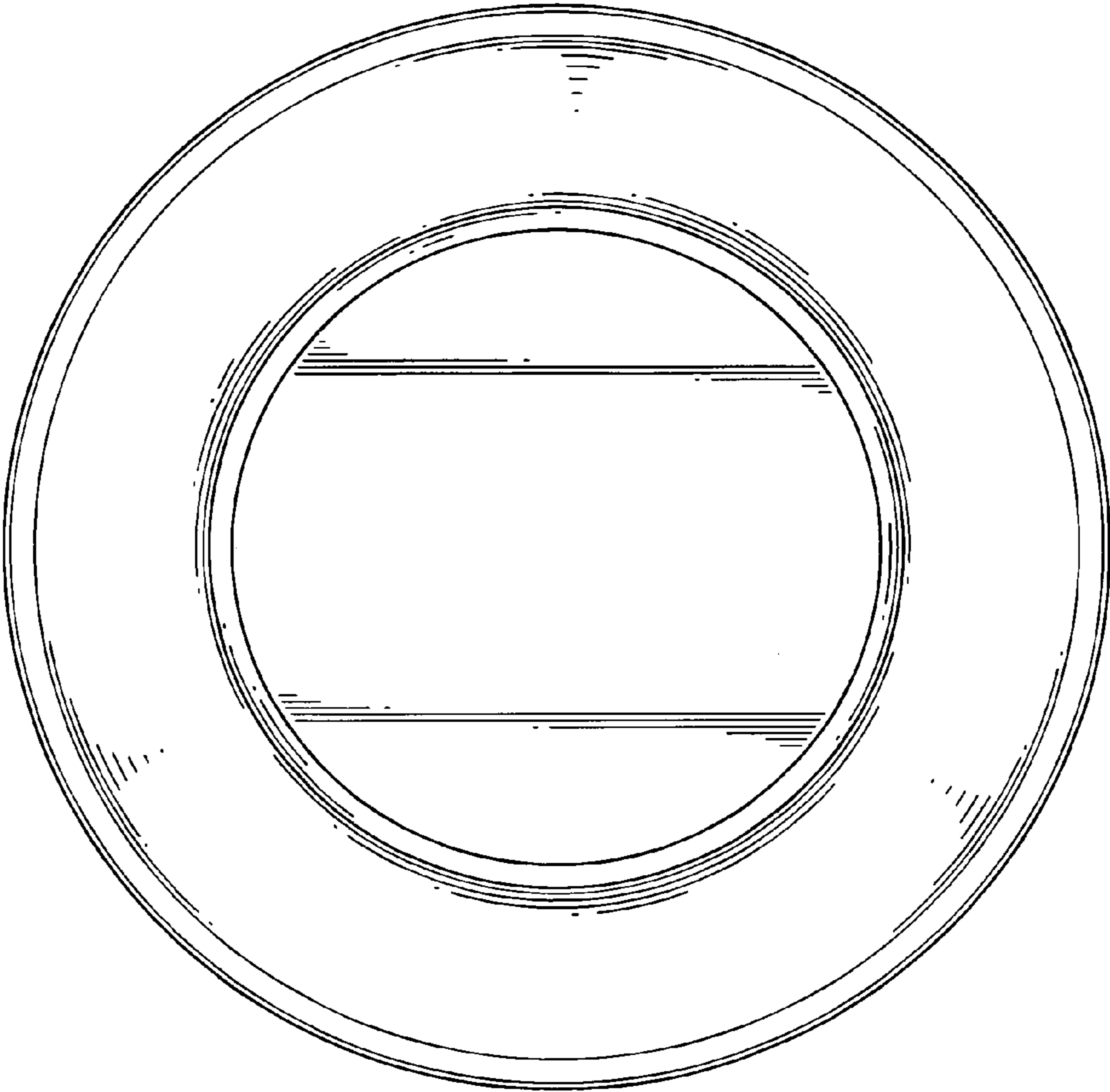

FIG.7



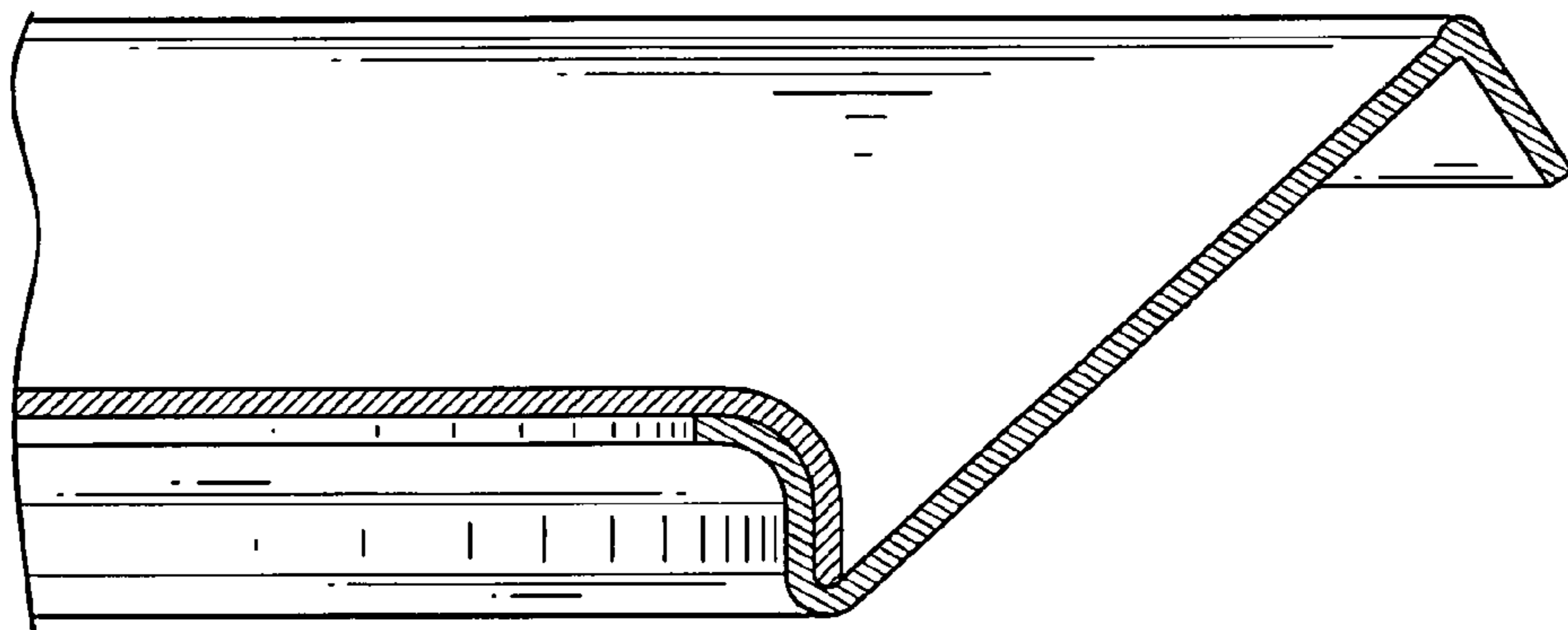

FIG. 8