



US00D738153S

(12) **United States Design Patent**
Brook

(10) **Patent No.:** **US D738,153 S**

(45) **Date of Patent:** **** Sep. 8, 2015**

(54) **COFFEE MAKER**

(71) Applicant: **Kenwood Limited**, Havant, Hampshire
(GB)

(72) Inventor: **Nicholas Brook**, Havant (GB)

(73) Assignee: **KENWOOD LIMITED**, Hampshire
(GB)

(**) Term: **14 Years**

(21) Appl. No.: **29/491,218**

(22) Filed: **May 19, 2014**

(30) **Foreign Application Priority Data**

Nov. 21, 2013 (EM) 002349779-0001

(51) **LOC (10) Cl.** **07-01**

(52) **U.S. Cl.**
USPC **D7/309; D7/311**

(58) **Field of Classification Search**
USPC D7/306-311, 305, 300; 99/279, 284,
99/290, 280, 299, 307, 323.1; 222/23;
62/395
CPC A47J 31/44
See application file for complete search history.

(56) **References Cited**

U.S. PATENT DOCUMENTS

D340,832 S * 11/1993 Macchi D7/306
D499,599 S * 12/2004 Morrison D7/309
D553,987 S * 10/2007 King D9/504

D626,367 S * 11/2010 Gross et al. D7/301
D633,056 S * 2/2011 Fujihara et al. D13/180
D642,851 S * 8/2011 Yui D7/307
D652,244 S * 1/2012 Richardson et al. D7/307
D669,727 S * 10/2012 Pagano D7/307
D675,472 S * 2/2013 Strayle D7/309
D696,056 S * 12/2013 Hong D7/309
D706,567 S * 6/2014 Strayle D7/309
D713,666 S * 9/2014 Van Baelen D7/306
D714,847 S * 10/2014 Broen et al. D15/89
D718,971 S * 12/2014 Young et al. D7/306

* cited by examiner

Primary Examiner — Marianne Pandozzi

(74) *Attorney, Agent, or Firm* — Brinks Gilson & Lione; G. Peter Nichols

(57) **CLAIM**

The ornamental design for a coffee maker, as shown and described.

DESCRIPTION

FIG. 1 is a front perspective view of a coffee maker of the present invention;
FIG. 2 is a front view;
FIG. 3 is a rear view;
FIG. 4 is a left side view;
FIG. 5 is a right side view;
FIG. 6 is a top view; and,
FIG. 7 is a bottom view.

The broken lines in the drawings are included for the purpose of illustration and form no part of the claimed design.

1 Claim, 5 Drawing Sheets

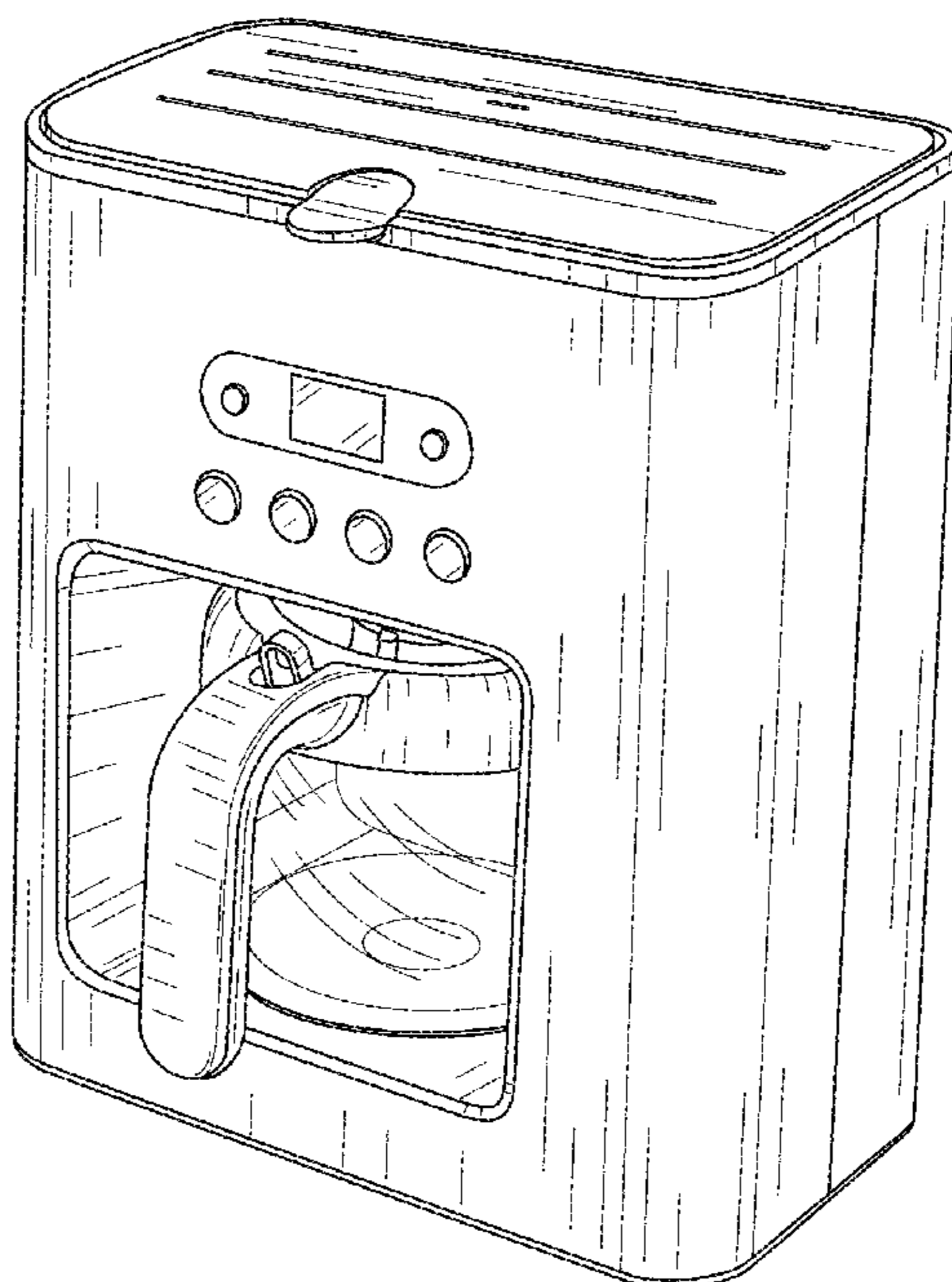

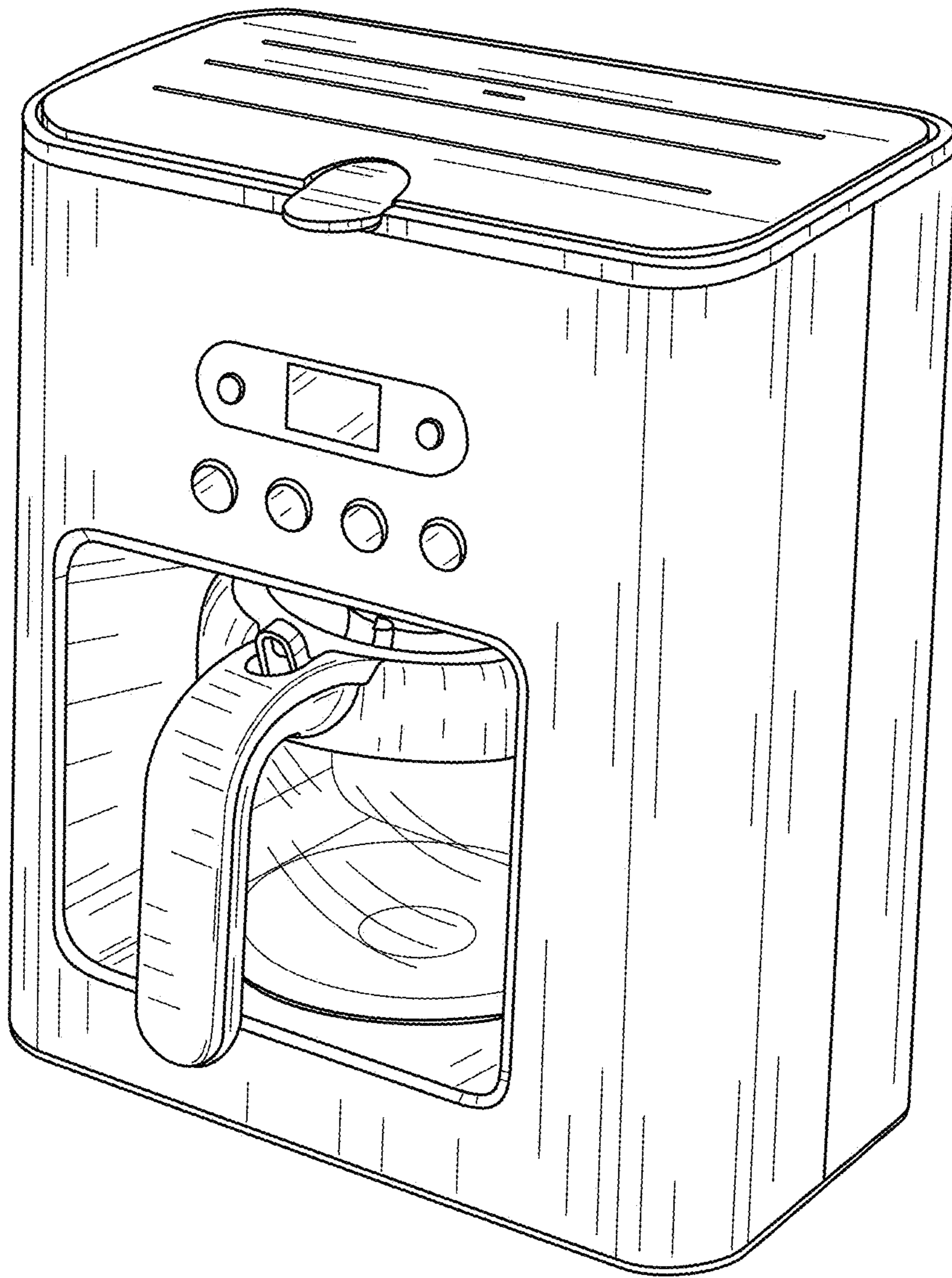

FIG. 1

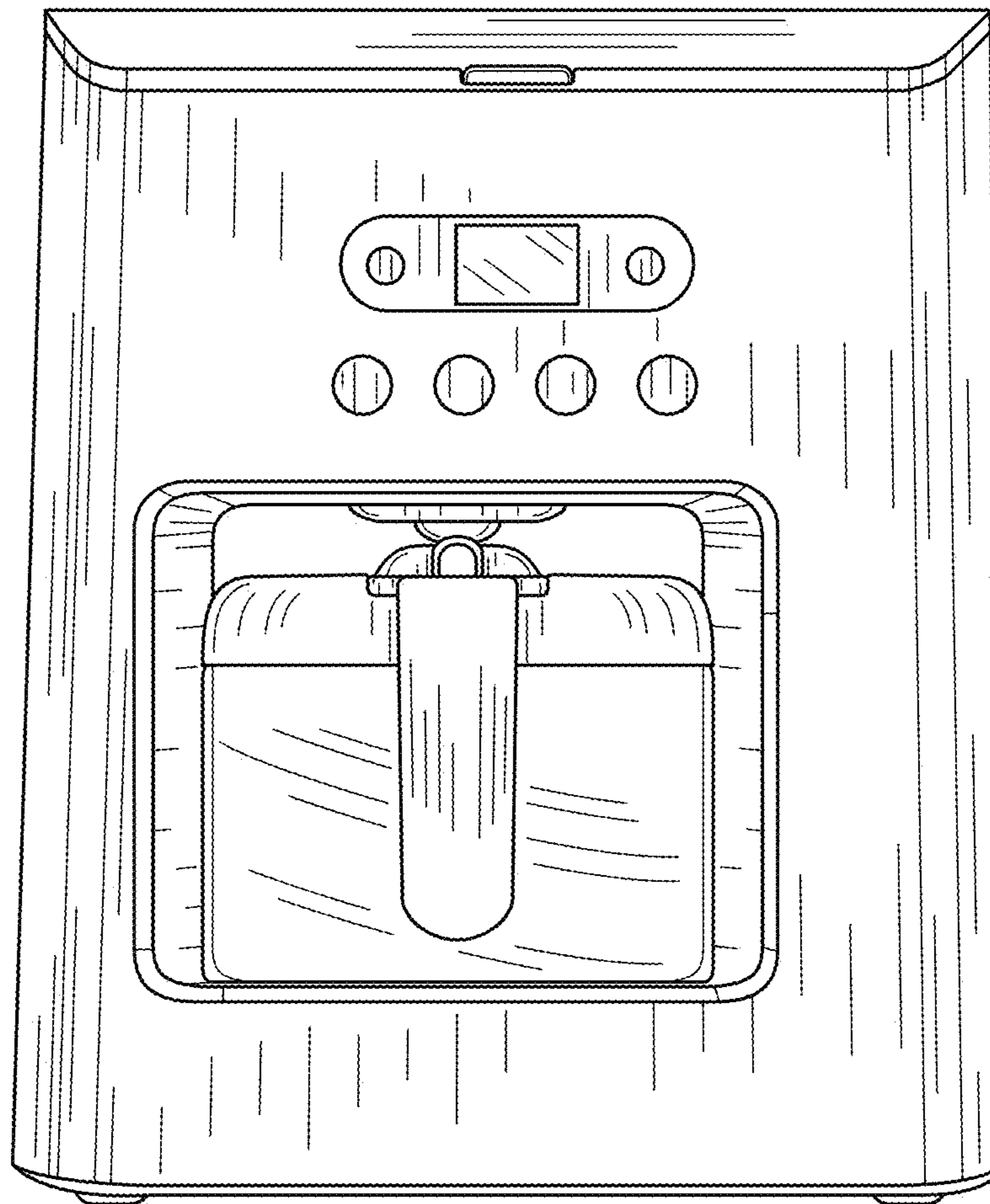

FIG. 2

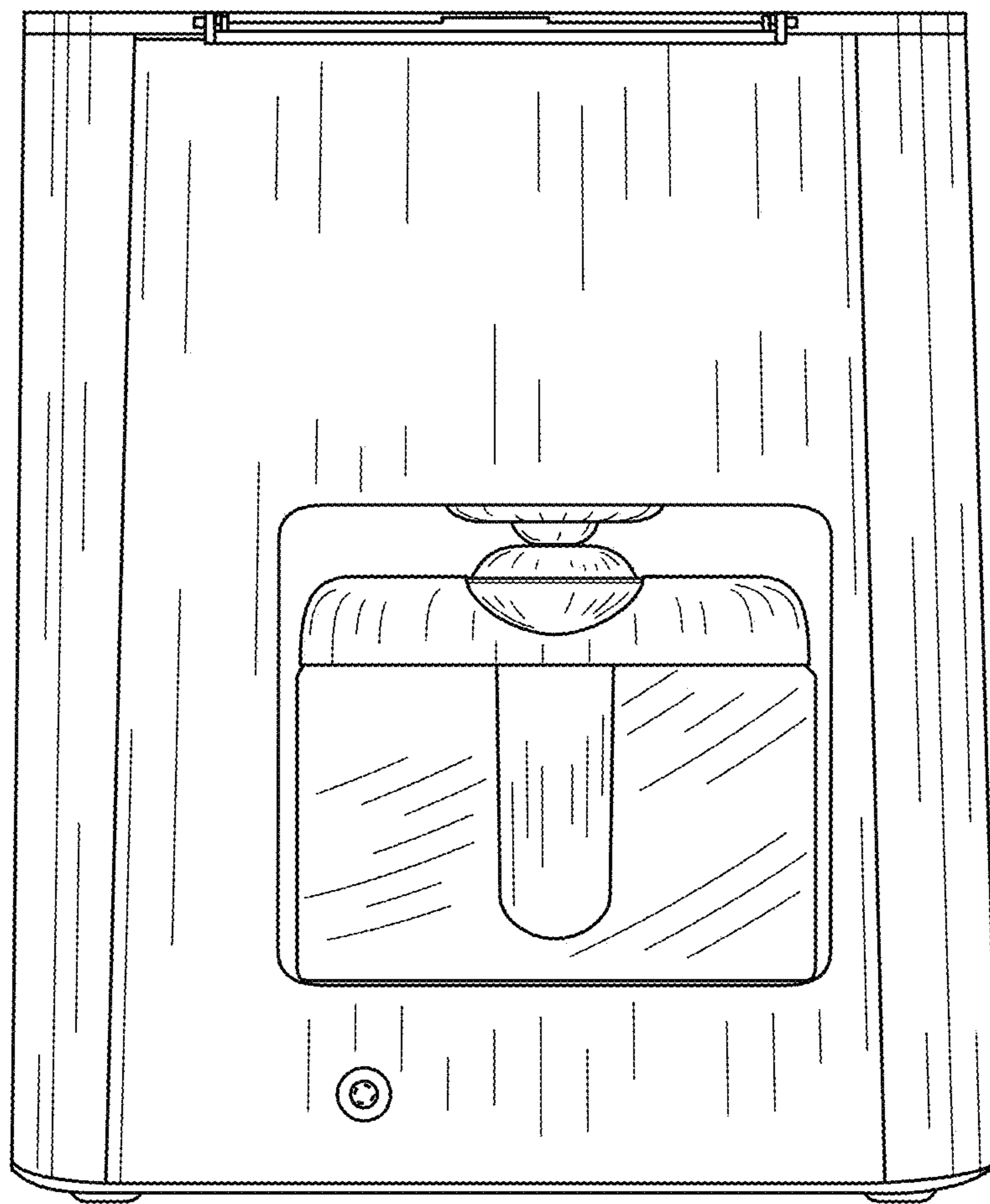

FIG. 3

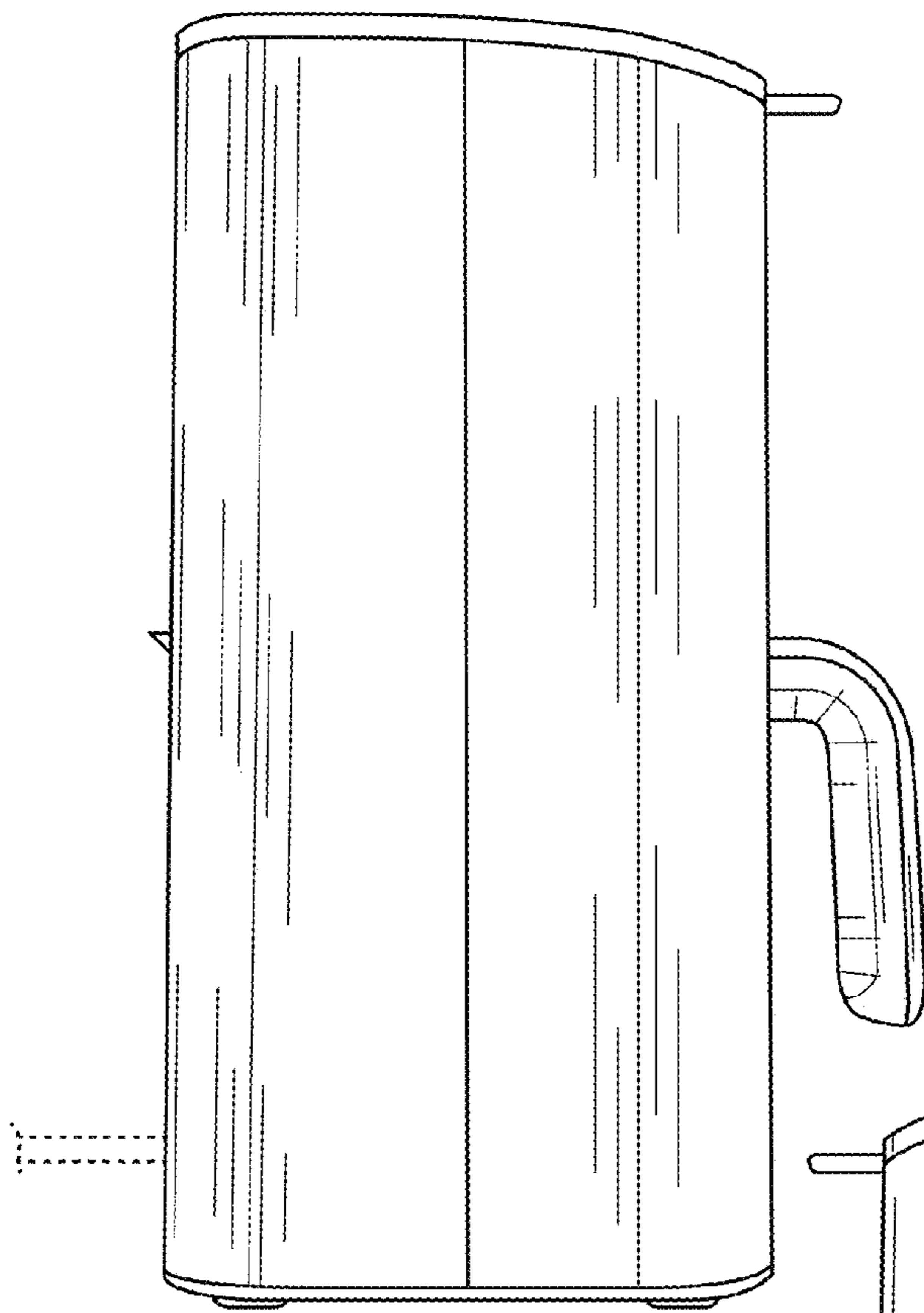

FIG. 4

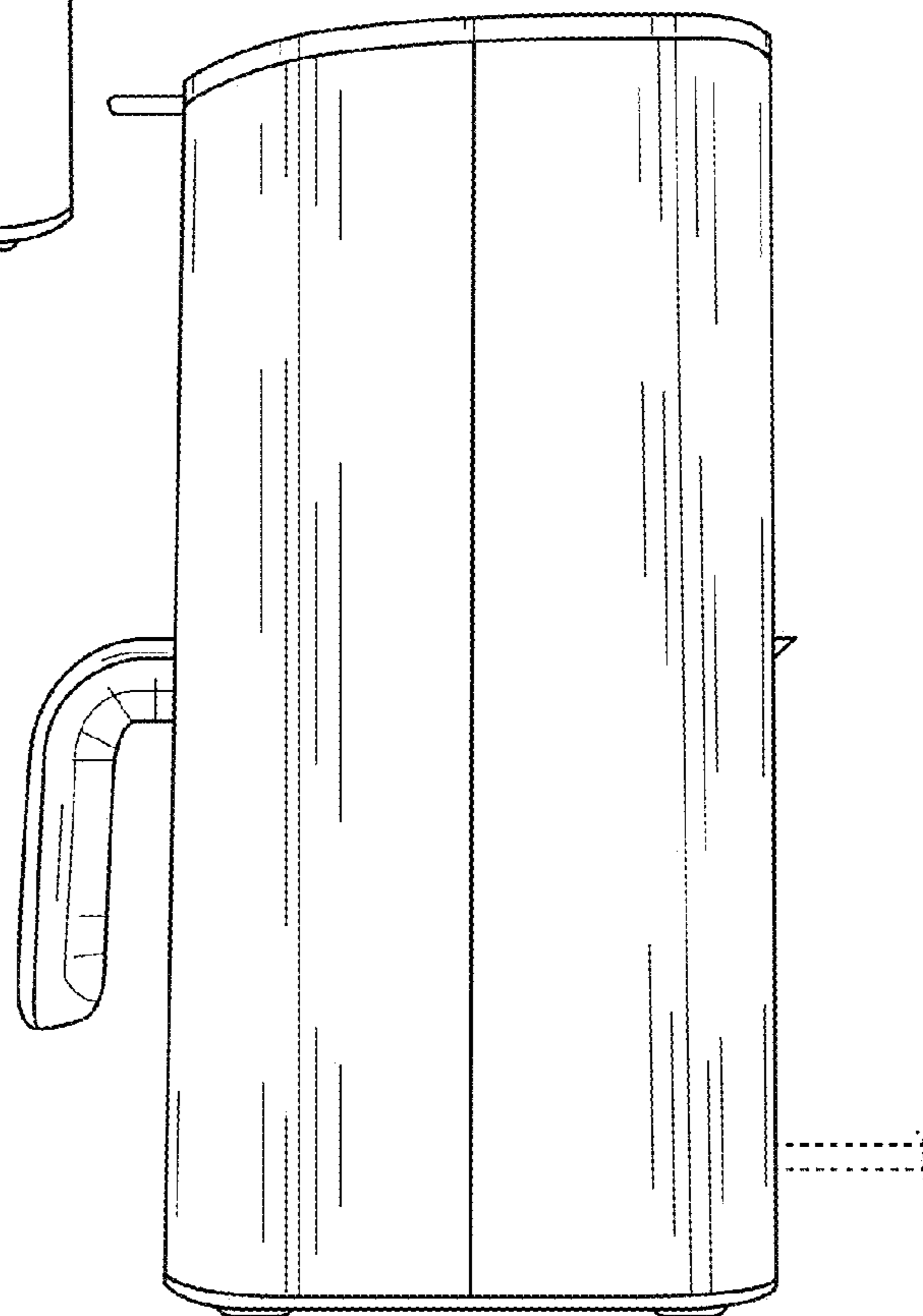

FIG. 5

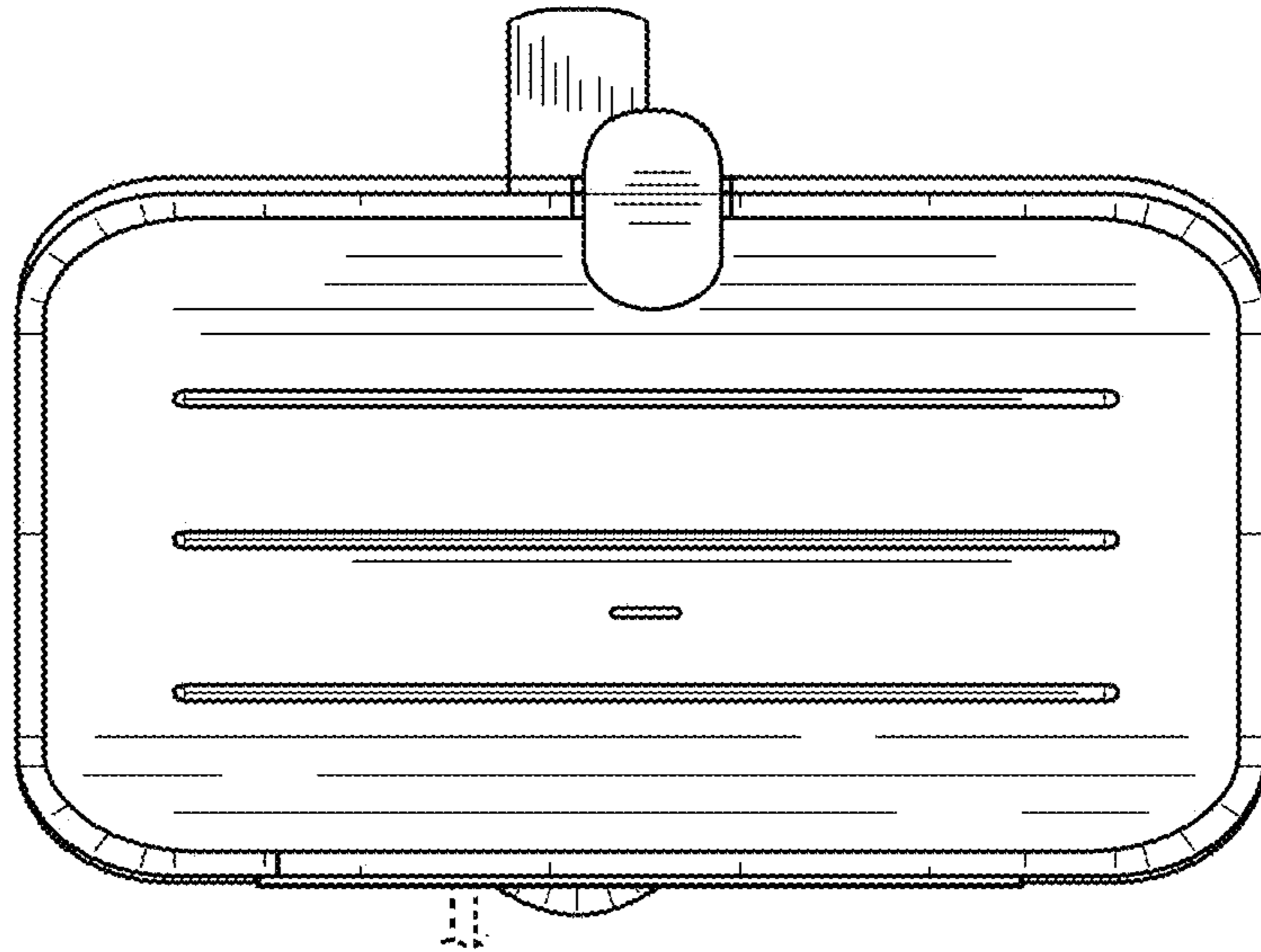

FIG. 6

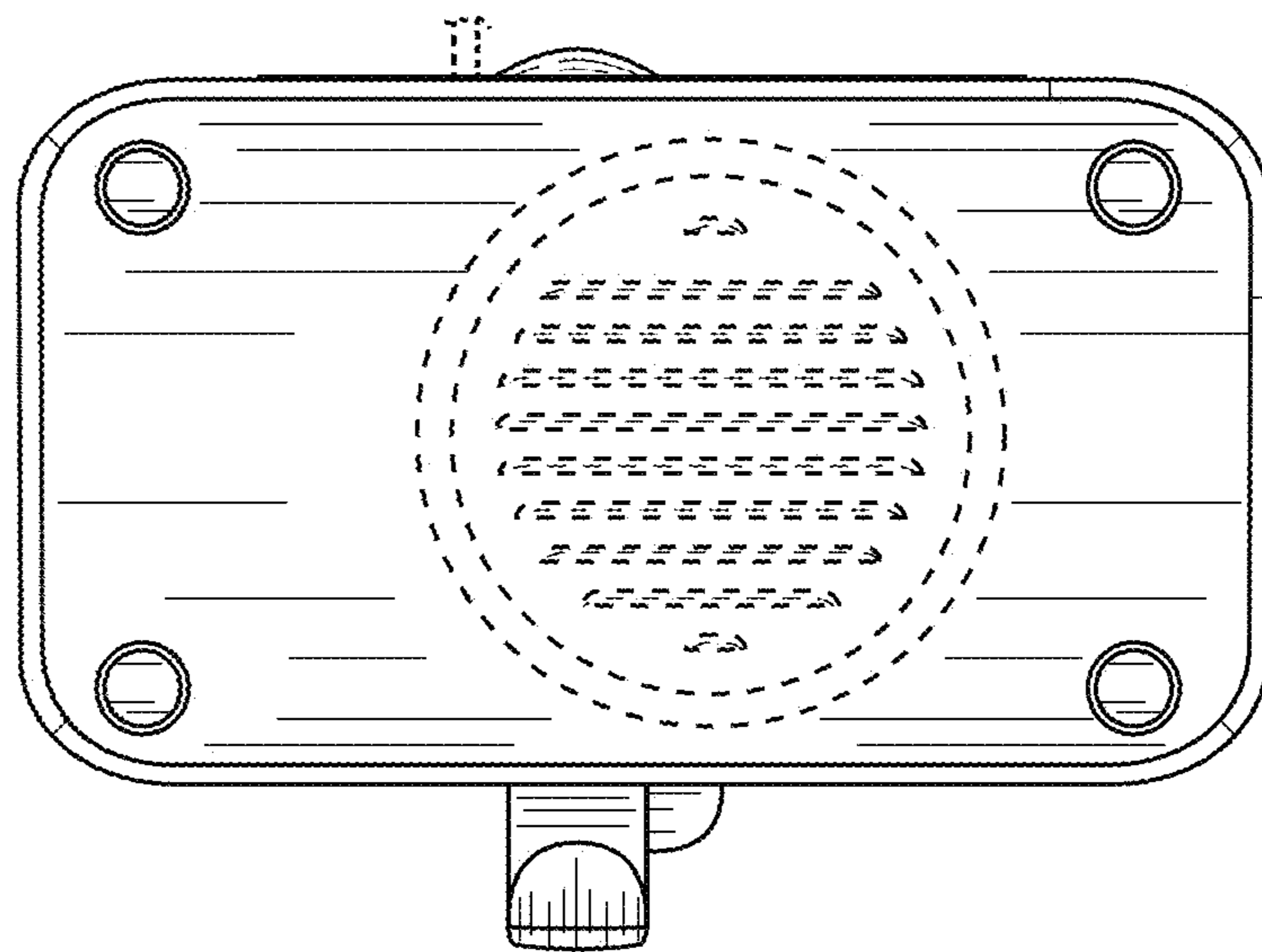

FIG. 7