



US00D738118S

(12) **United States Design Patent**
Gyanendra et al.

(10) **Patent No.:** **US D738,118 S**
(45) **Date of Patent:** **** Sep. 8, 2015**

- (54) **MIRROR WITH FAN**
- (71) Applicant: **Global Product Resources, Inc.**,
Temecula, CA (US)
- (72) Inventors: **Punit Gyanendra**, Temecula, CA (US);
Louis Weil, III, Temecula, CA (US);
Jeffrey Amon, Temecula, CA (US);
Martin Reed, Temecula, CA (US)
- (73) Assignee: **Global Products Resources, Inc.**,
Temecula, CA (US)

D441,068 S	4/2001	Bogazzi	
D445,494 S	7/2001	Leslie	
6,273,585 B1 *	8/2001	Wu	362/135
D509,369 S *	9/2005	Snell	D6/310
7,048,406 B1 *	5/2006	Shih	362/135
D540,549 S *	4/2007	Yue	D6/312
D544,078 S *	6/2007	Geringer	D23/328
D580,541 S *	11/2008	Bucher et al.	D23/378
D581,038 S *	11/2008	Boswell	D23/378
D581,581 S *	11/2008	Huang	D26/118
D614,280 S	4/2010	Dyson et al.	

(Continued)

(**) Term: **14 Years**

(21) Appl. No.: **29/518,394**

(22) Filed: **Feb. 23, 2015**

(51) **LOC (10) Cl.** **06-07**

(52) **U.S. Cl.**
USPC **D6/310; D6/312; D6/300; D6/309**

(58) **Field of Classification Search**
USPC D6/300-314, 320, 321; D20/10, 21,
D20/122, 123, 126; 359/879; 40/735, 738,
40/597, 744, 745, 754, 765, 768, 769, 790,
40/838; 248/466; D24/139; D16/134-136;
D26/44, 56, 63, 107, 24, 59; D23/370,
D23/378
CPC A45D 42/10; A45D 42/00; A45D 42/16;
A47G 1/02

See application file for complete search history.

(56) **References Cited**

U.S. PATENT DOCUMENTS

D80,595 S *	2/1930	Becker	D6/309
D322,669 S *	12/1991	Yamamoto et al.	D23/378
5,090,300 A *	2/1992	Berenstein	454/370
D358,678 S *	5/1995	Lundquist et al.	D26/106
5,654,824 A *	8/1997	Tarr et al.	359/507

OTHER PUBLICATIONS

Oscillating Tower Fan (via Wayfair), available Jul. 17, 2013, [online], [site visited Jul. 24, 2015]. Available from internet, <URL: <http://www.wayfair.com/Kaz-Oscillating-Tower-Fan-HY-280-YOV1003.html>>.*

(Continued)

Primary Examiner — Cathron Brooks
Assistant Examiner — Teddy Falloway

(74) *Attorney, Agent, or Firm* — ARC IP Law, PC; Joseph J. Mayo

(57) **CLAIM**

The ornamental design for a mirror with fan, as shown and described.

DESCRIPTION

FIG. 1 is a perspective view of a mirror with fan.
FIG. 2 is a front view of the mirror with fan.
FIG. 3 is a rear view of the mirror with fan.
FIG. 4 is a left side view of the mirror with fan, of which right is a mirror image.
FIG. 5 is a top view of the mirror with fan; and,
FIG. 6 is a bottom view of the mirror with fan.

1 Claim, 5 Drawing Sheets

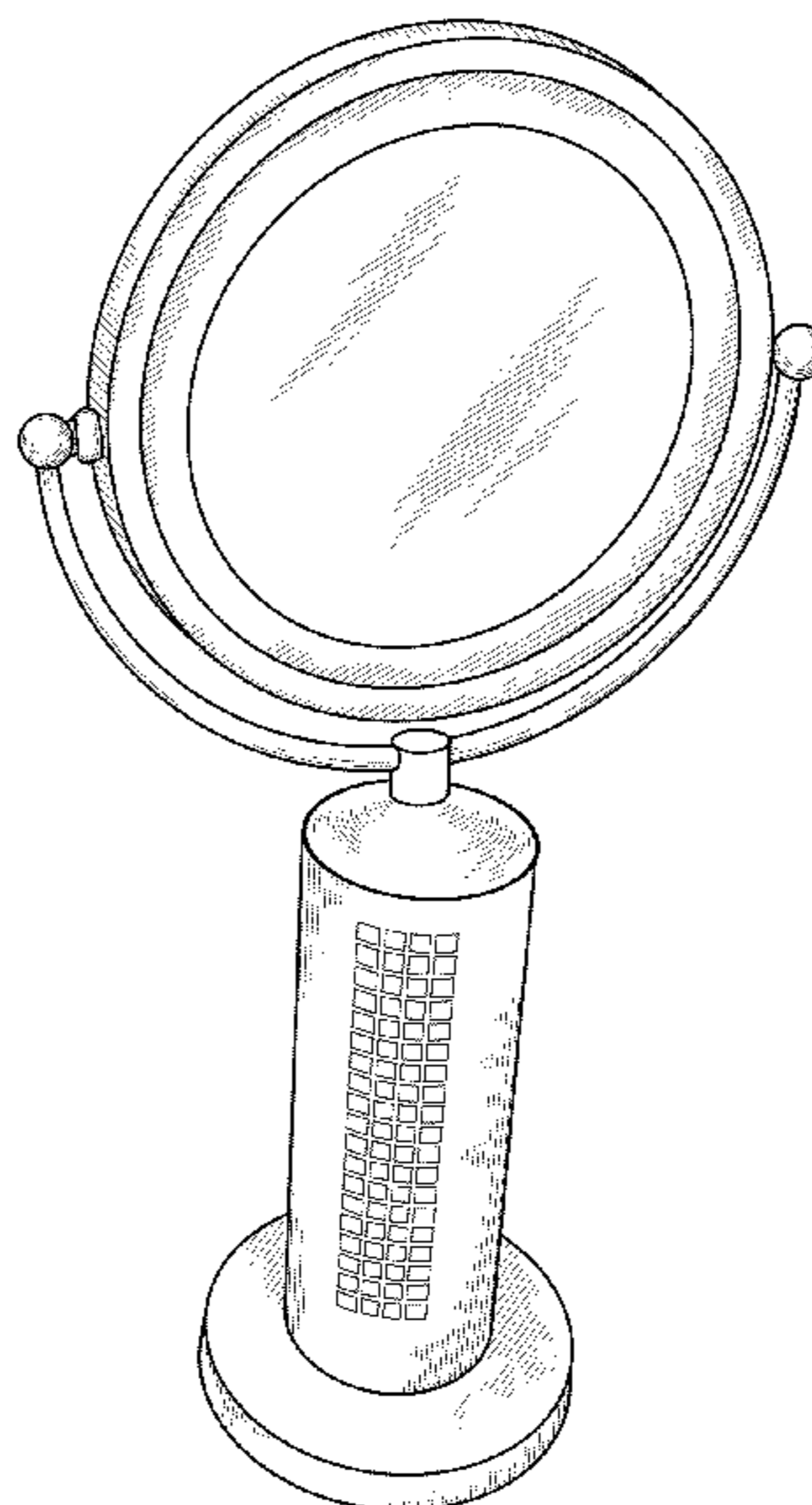

(56)

References Cited

U.S. PATENT DOCUMENTS

8,162,502 B1 * 4/2012 Zadro 362/141
 8,356,908 B1 * 1/2013 Zadro 362/136
 D676,536 S * 2/2013 Roach et al. D23/328
 D678,993 S * 3/2013 Kung-Hua D23/370
 D685,078 S * 6/2013 Sidell D23/378
 D698,428 S * 1/2014 Sands et al. D23/328
 8,746,917 B2 * 6/2014 Zimmerman 362/139
 D727,630 S * 4/2015 Zadro D6/312
 D729,373 S * 5/2015 Dos Reis et al. D23/370
 D729,374 S * 5/2015 Dos Reis et al. D23/370
 D729,375 S * 5/2015 Dos Reis et al. D23/370
 D729,525 S * 5/2015 Tsai D6/300
 D730,065 S * 5/2015 Tsai D6/310
 2007/0166172 A1 * 7/2007 Gyanendra et al. 417/200

2008/0278935 A1 * 11/2008 Lin 362/183
 2010/0118520 A1 * 5/2010 Stern et al. 362/135
 2013/0077292 A1 * 3/2013 Zimmerman 362/142
 2014/0014740 A1 * 1/2014 Sands et al. 239/289

OTHER PUBLICATIONS

Brookstone Tower Fan (via Bed Bath & Beyond), available Jun. 18, 2014, [online], [site visited Jul. 24, 2015]. Available from internet, <URL: <http://www.bedbathandbeyond.com/1/1/206805-brookstone-mighty-max-tower-fan.html>>.*

Mini Lipstick Mirror (via Amazon), available Mar. 2, 2014, [online], [site visited Jul. 24, 2015]. Available from internet, <URL: <http://www.amazon.co.uk/Markue-Lipstick-Mirror-Shocking-Attractive/dp/B00IQYIZS>>.*

* cited by examiner

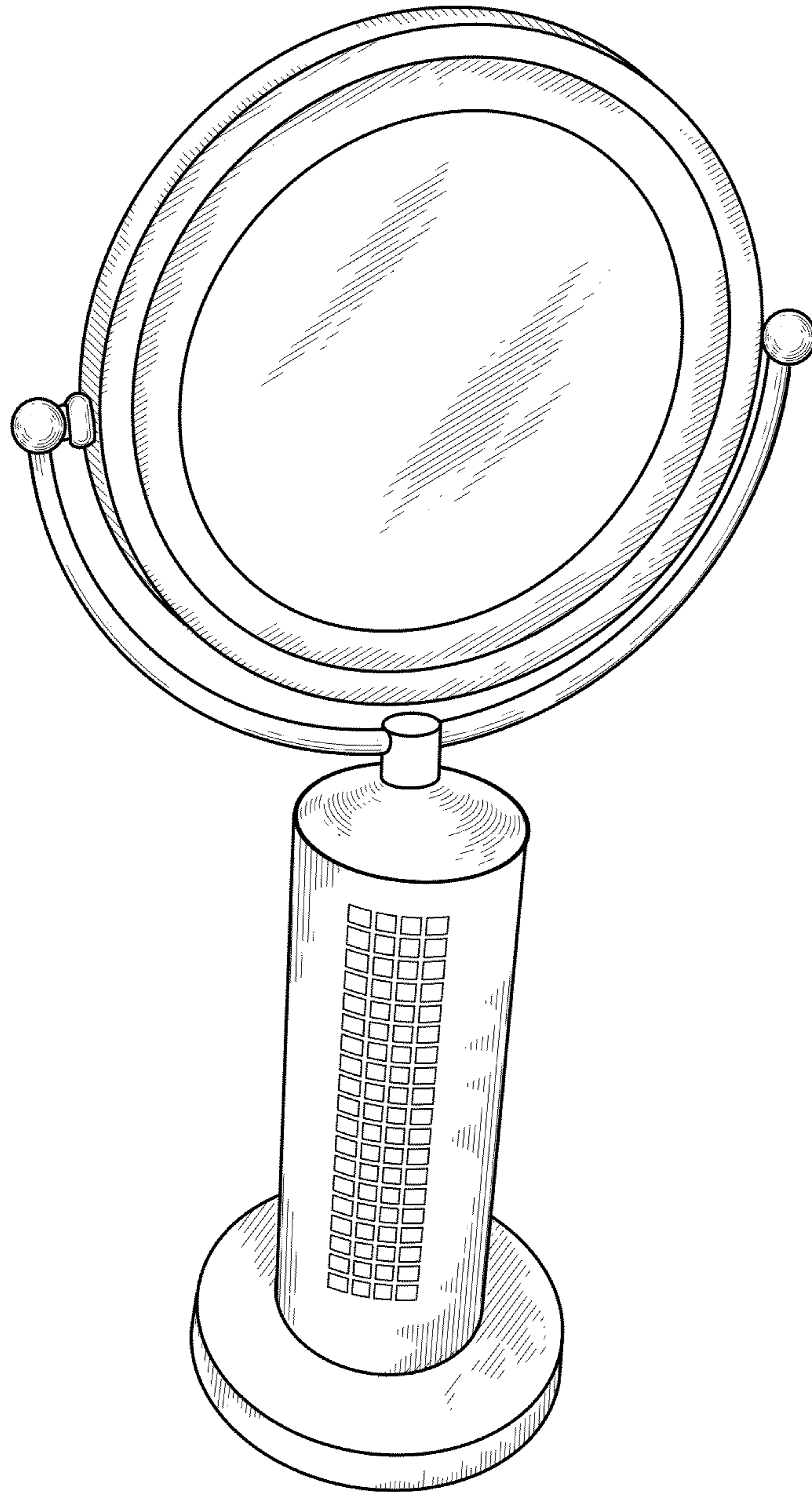

FIG. 1

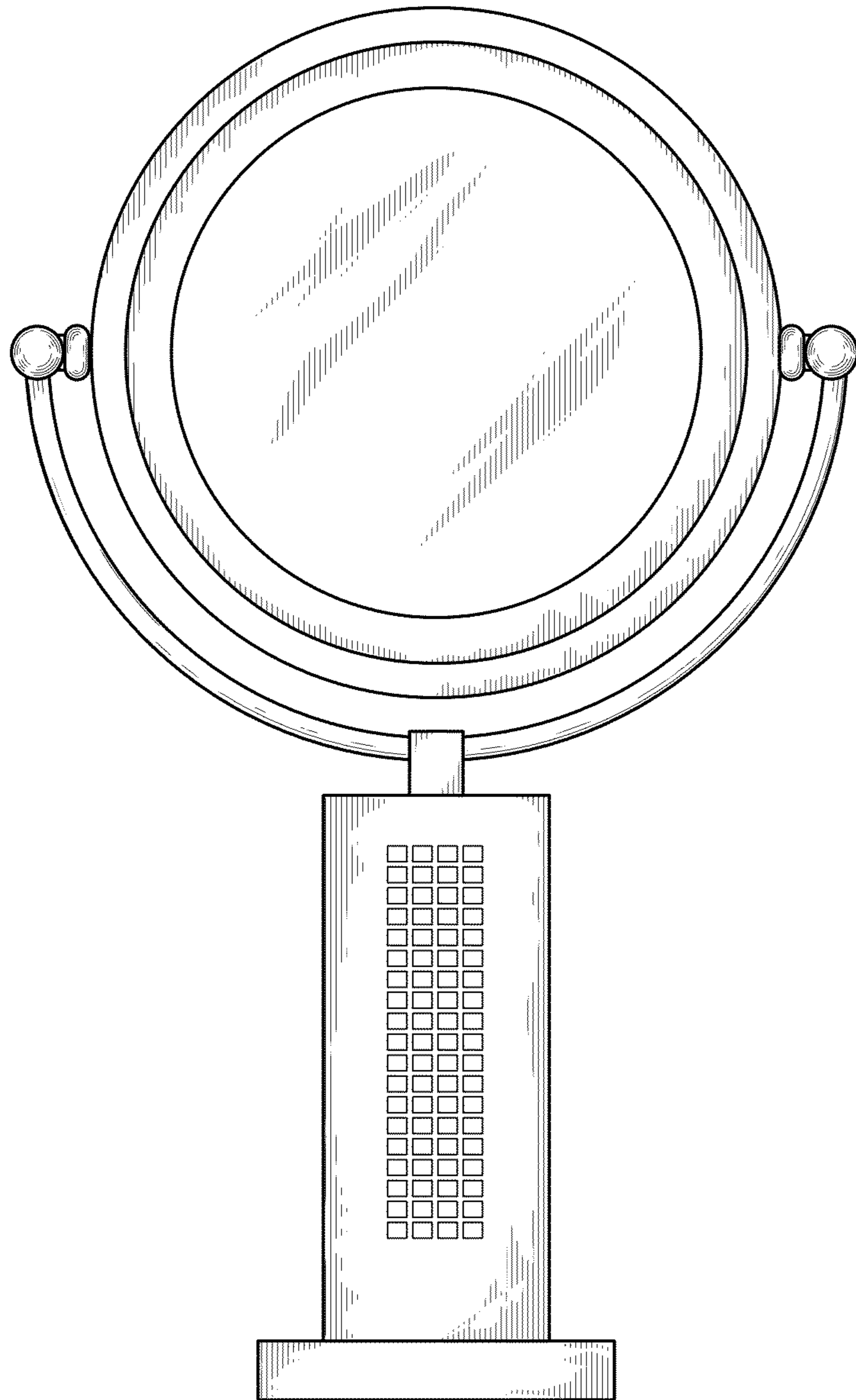

FIG. 2

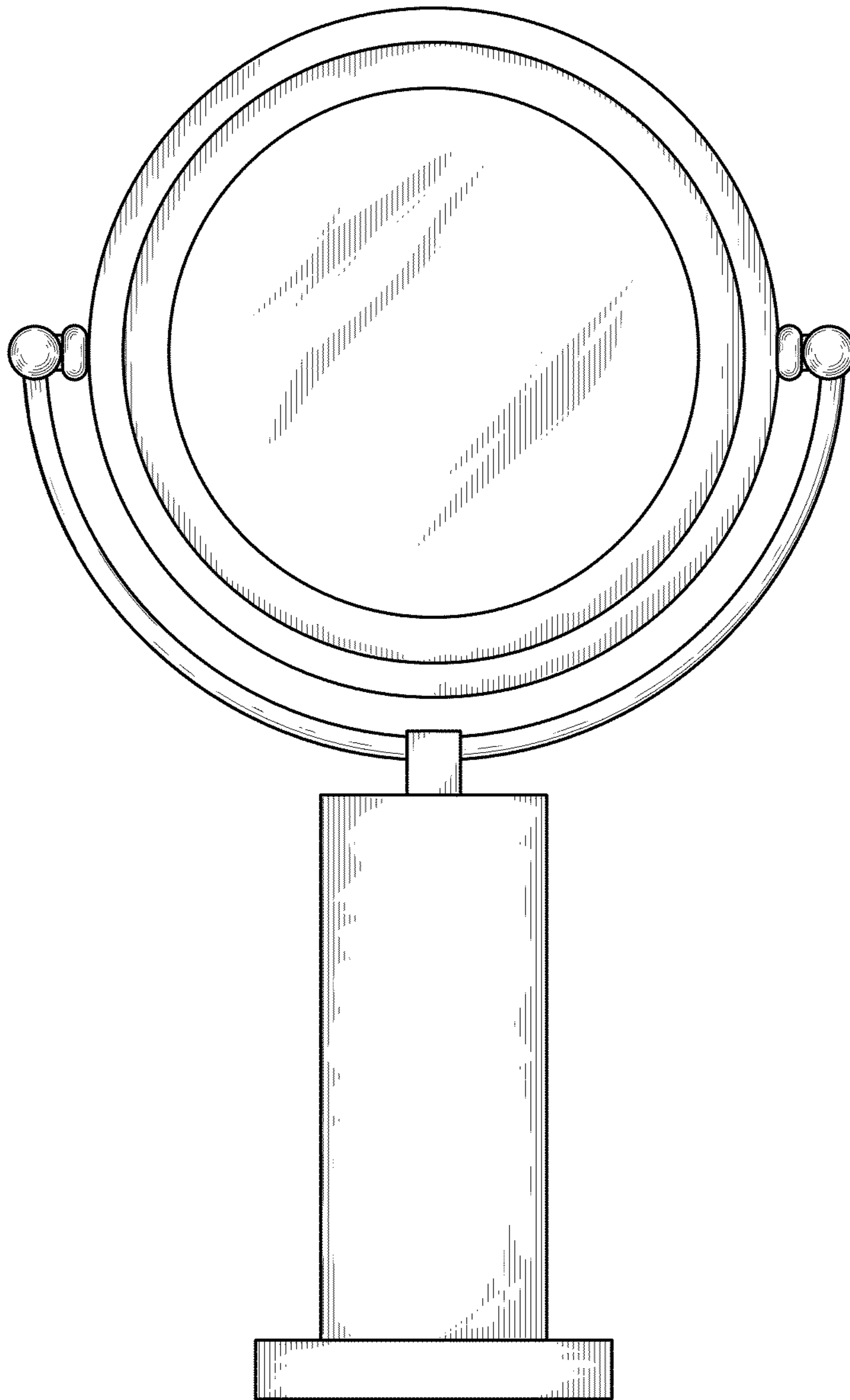

FIG. 3

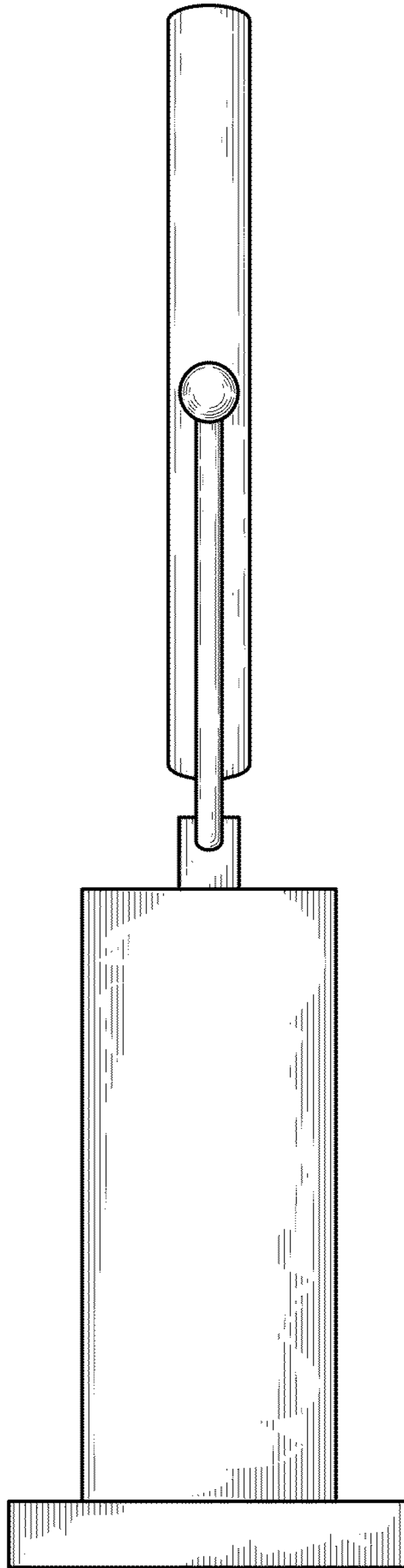

FIG. 4

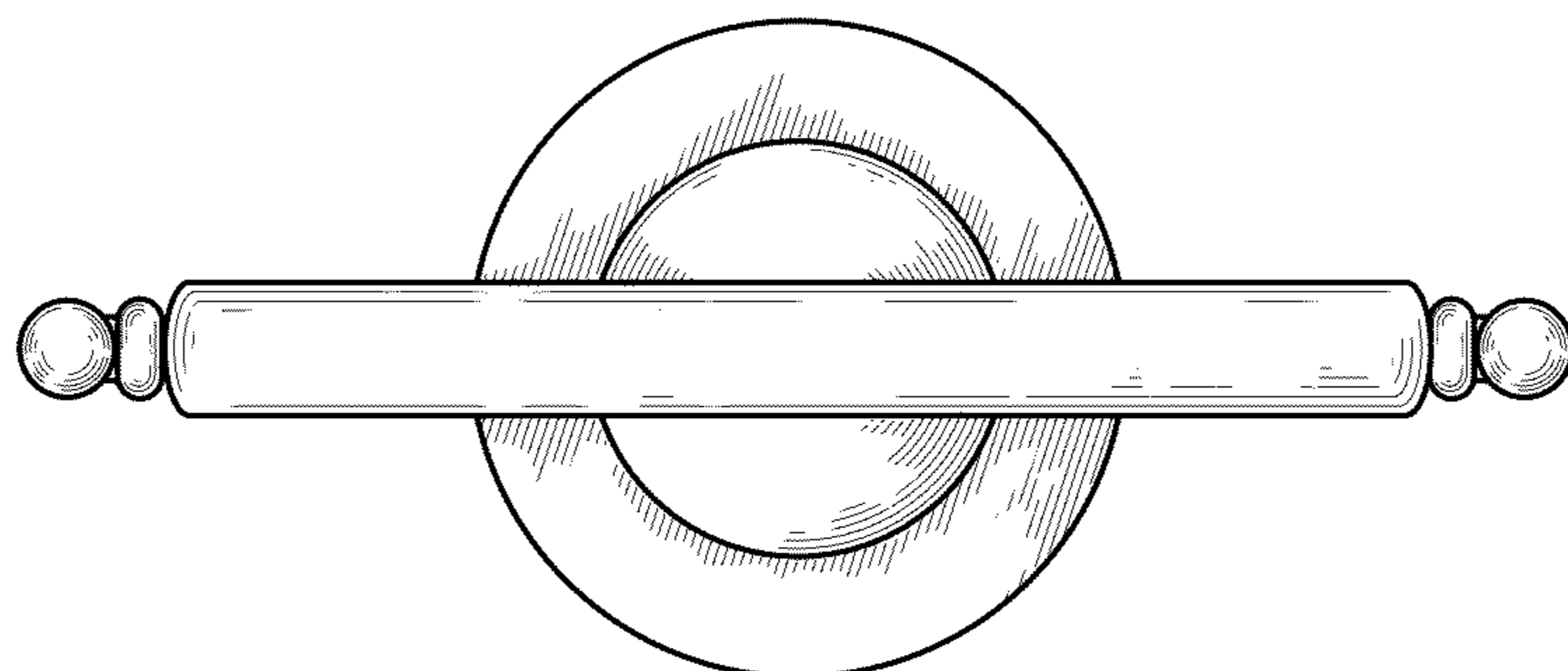

FIG. 5

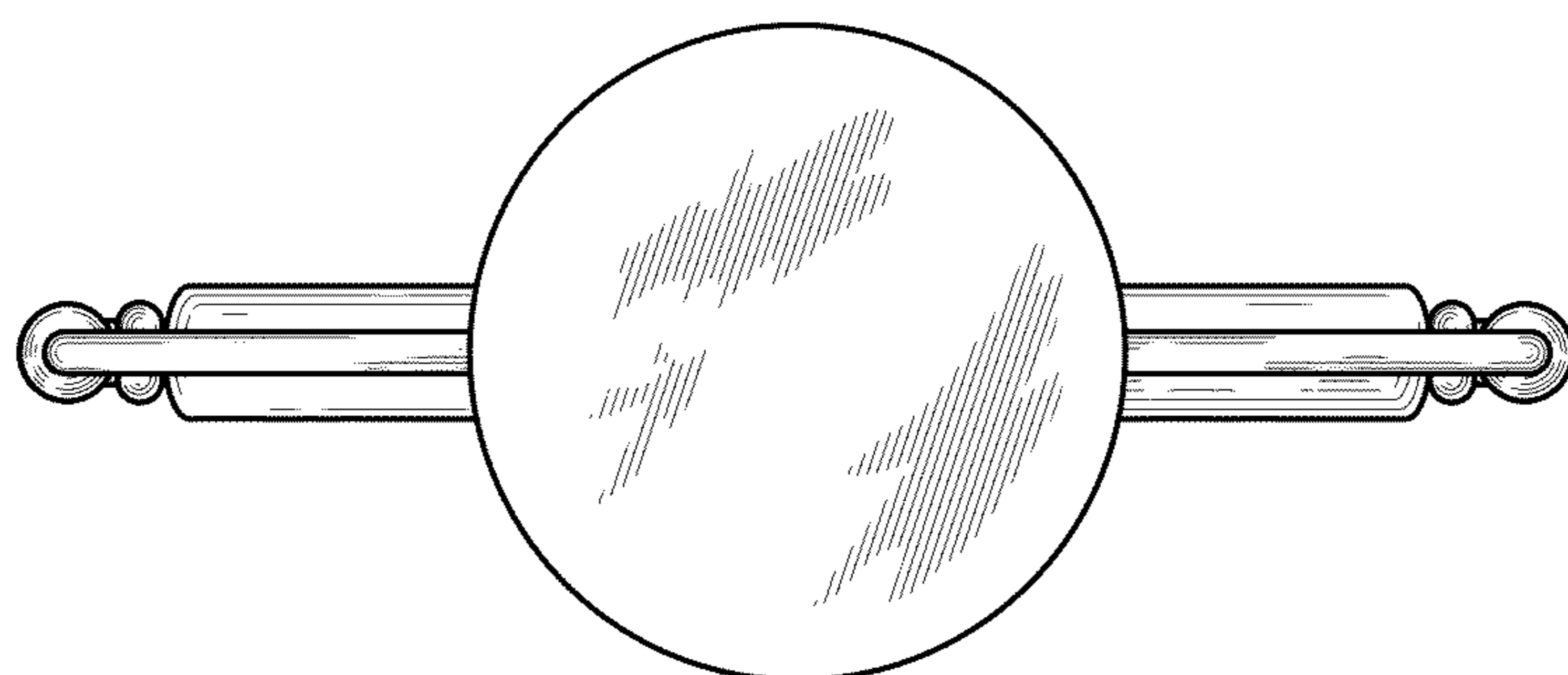

FIG. 6