



US00D738041S

(12) **United States Design Patent**
Ochiai

(10) **Patent No.:** **US D738,041 S**

(45) **Date of Patent:** **** Sep. 1, 2015**

(54) **SAFETY RAZOR**

(71) Applicant: **KAI R&D CENTER CO., LTD.**,
Seki-shi, Gifu-ken (JP)

(72) Inventor: **Shogo Ochiai**, Seki (JP)

(73) Assignee: **KAI R&D CENTER CO., LTD.**,
Gifu-ken (JP)

(**) Term: **14 Years**

(21) Appl. No.: **29/482,342**

(22) Filed: **Feb. 18, 2014**

(30) **Foreign Application Priority Data**

Aug. 23, 2013 (JP) D2013-019274

(51) **LOC (10) Cl.** **28-03**

(52) **U.S. Cl.**
USPC **D28/48**

(58) **Field of Classification Search**
USPC D28/44-48
CPC B62B 21/00-21/12; B62B 21/14;
B62B 21/16; B62B 21/165; B62B 21/18;
B62B 21/185; B62B 21/20-21/227; B62B
21/24; B62B 21/28; B62B 21/30; B62B
21/32; B62B 21/40; B62B 21/4062; B62B
21/4068; B62B 21/4075; B62B 21/52-21/528

See application file for complete search history.

(56) **References Cited**

U.S. PATENT DOCUMENTS

D536,485 S	2/2007	Wonderley et al.	
D619,763 S	7/2010	Coresh	
D624,699 S *	9/2010	Micinilio	D28/46
D674,545 S *	1/2013	Barrow et al.	D28/46
D674,551 S *	1/2013	Barrow et al.	D28/48
D698,998 S *	2/2014	Lukan	D28/46
D699,394 S *	2/2014	Woon	D28/46

FOREIGN PATENT DOCUMENTS

JP 1408800 S 2/2011

* cited by examiner

Primary Examiner — Jennifer Rivard

(74) *Attorney, Agent, or Firm* — Posz Law Group, PLC

(57) **CLAIM**

The ornamental design for a safety razor, as shown and described.

DESCRIPTION

FIG. 1 is a front, top and right side perspective view of a safety razor showing my new design; FIG. 2 is a rear, bottom and left side perspective view thereof; FIG. 3 is a front view thereof, the rear view being a mirror image of FIG. 3; FIG. 4 is a top plan view thereof; FIG. 5 is a bottom plan view thereof; FIG. 6 is an enlarged right side view thereof; and, FIG. 7 is an enlarged left side view thereof. The evenly spaced dashed lines illustrate portions of the safety razor and form no part of the claimed design. The dashed-dotted lines denote the boundary of the claim and form no part of the claimed design.

1 Claim, 7 Drawing Sheets

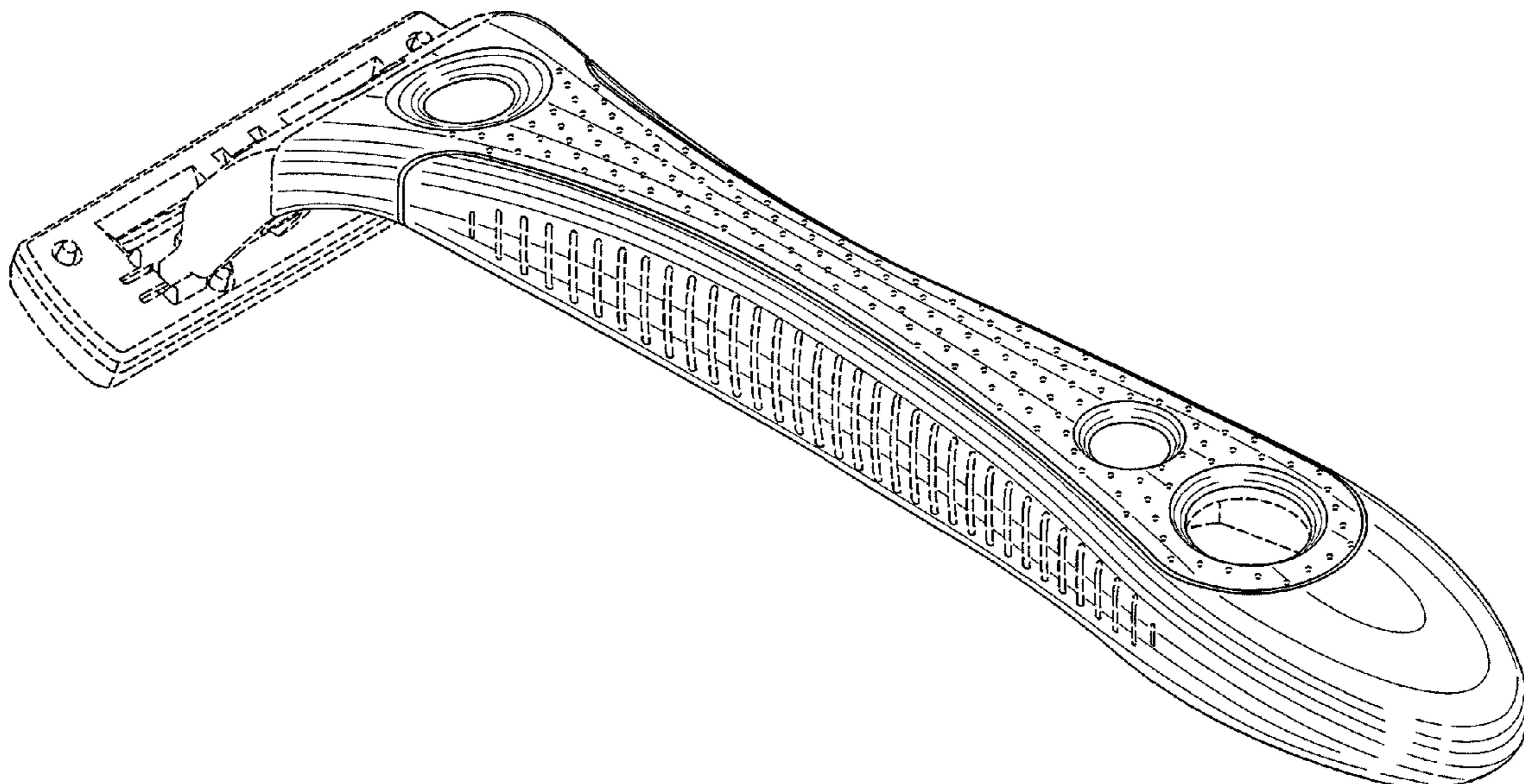

FIG. 1

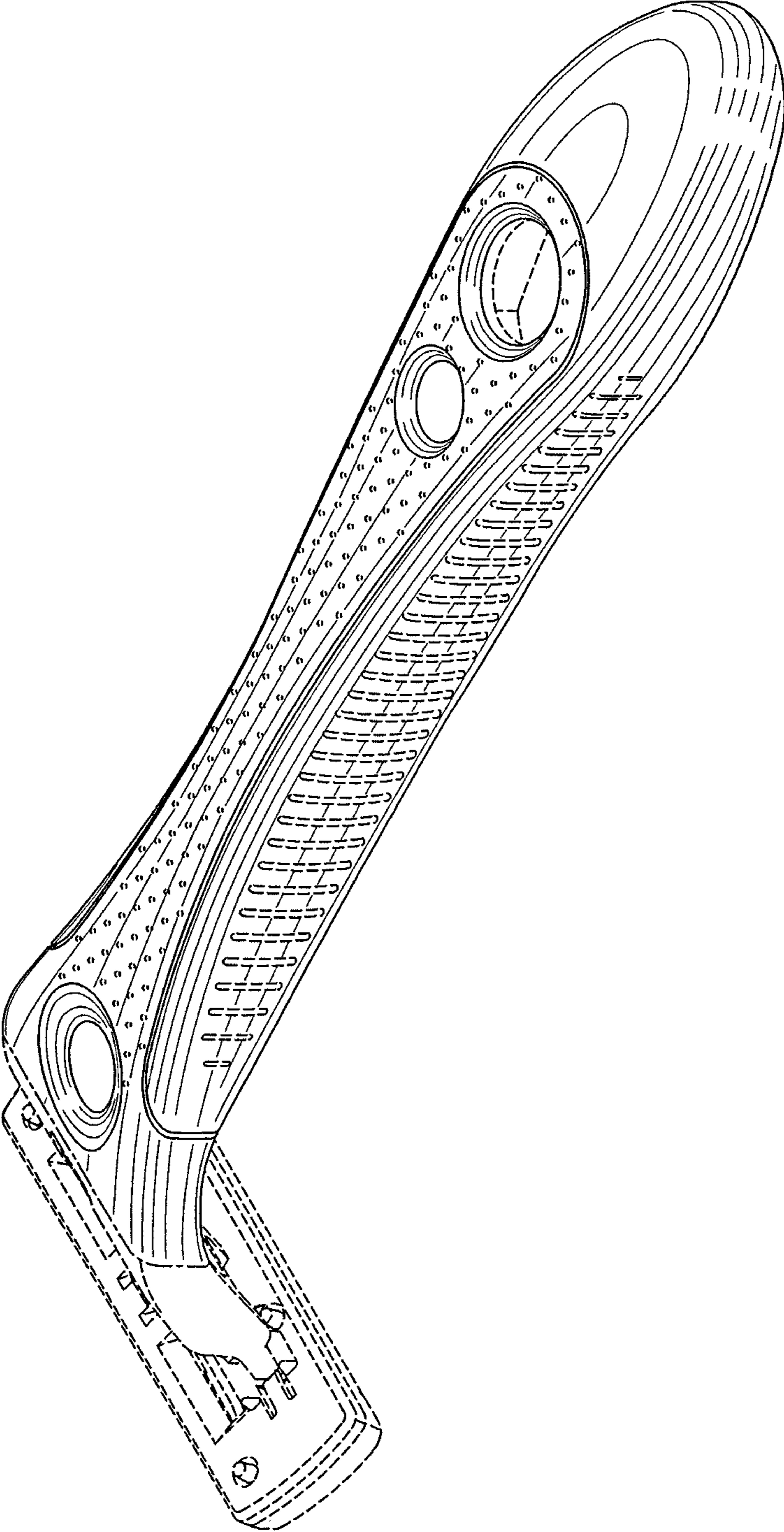

FIG. 2

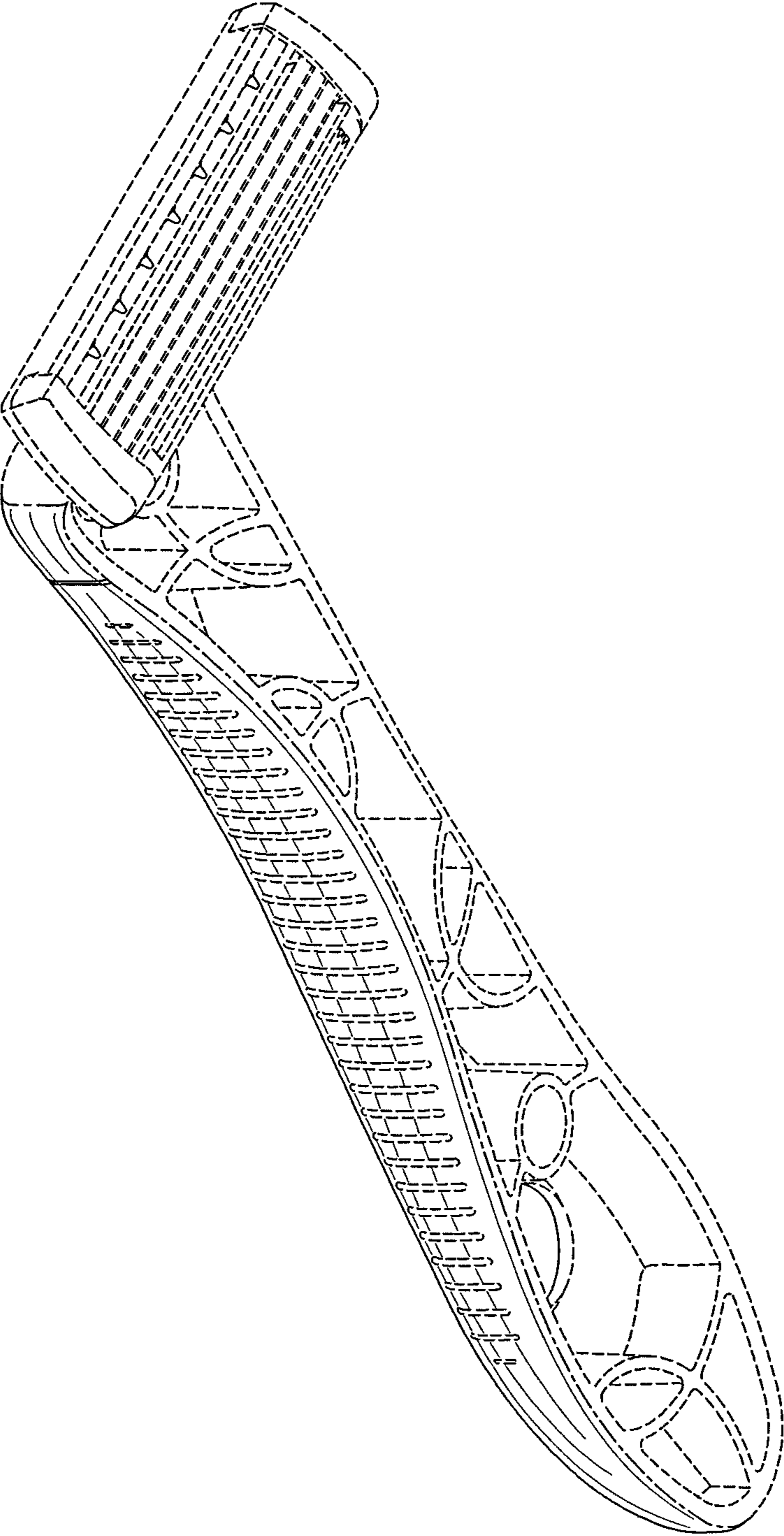

FIG. 3

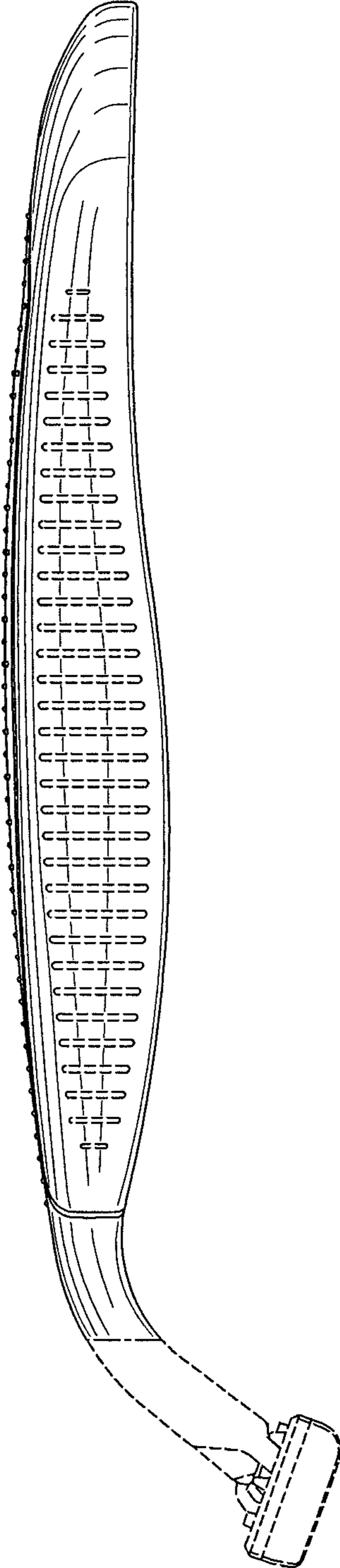

FIG. 4

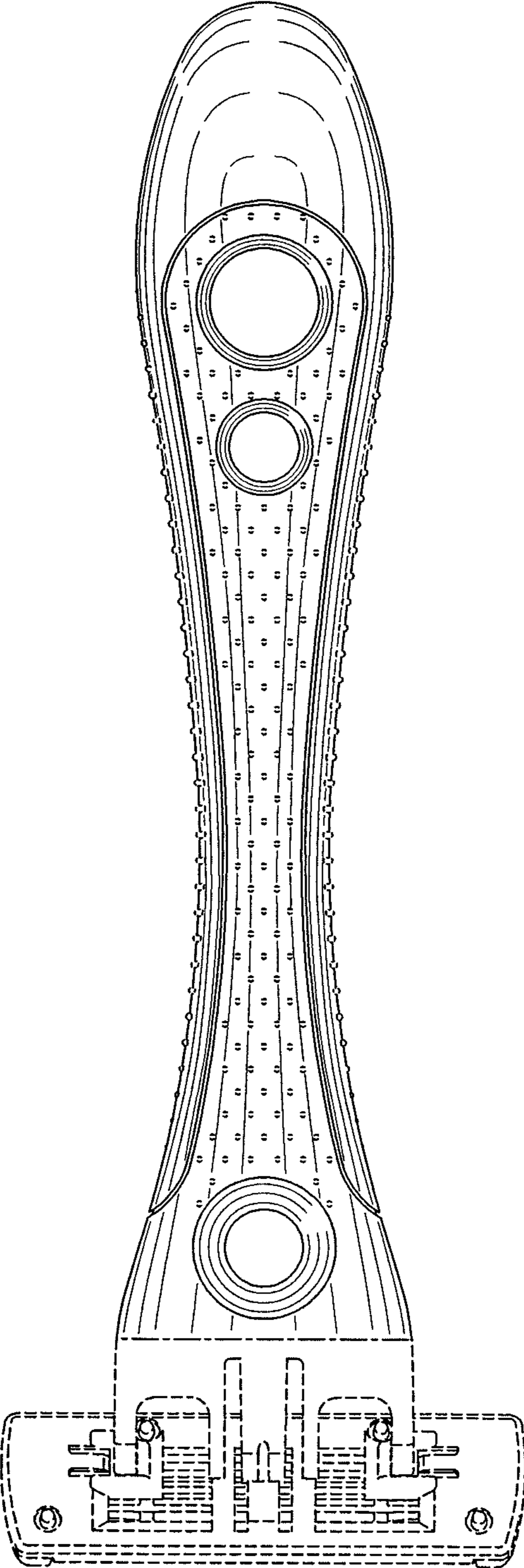

FIG. 5

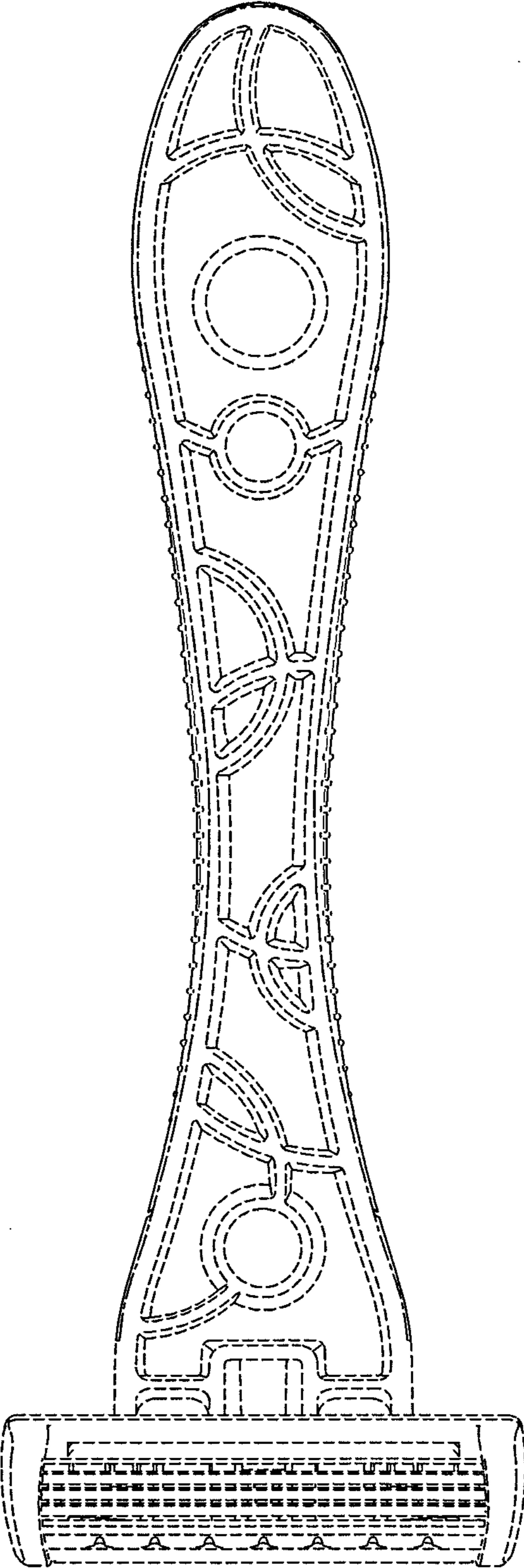

FIG. 6

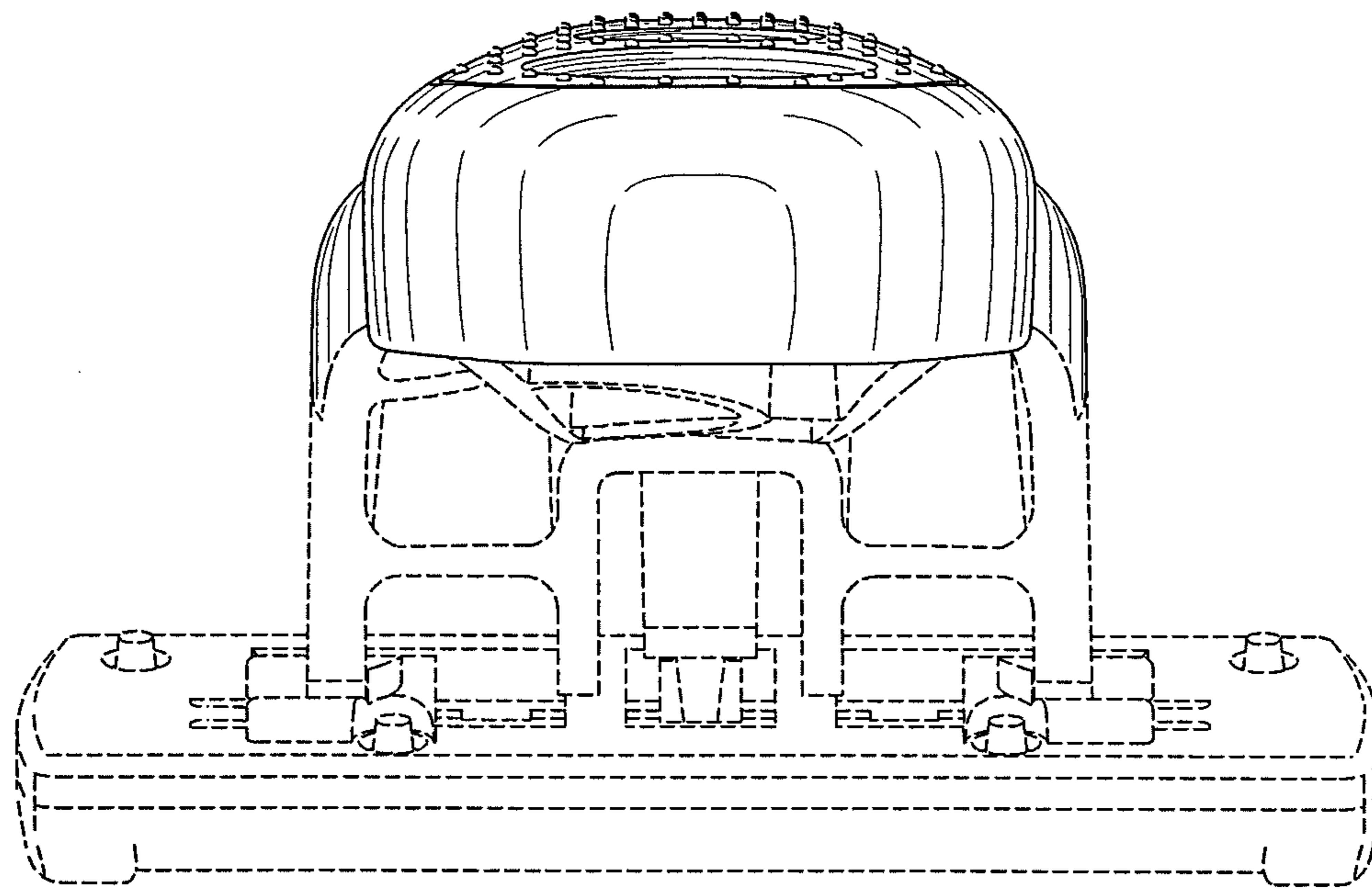

FIG. 7

