



US00D737902S

(12) **United States Design Patent**
Choi

(10) **Patent No.:** **US D737,902 S**
(45) **Date of Patent:** **** Sep. 1, 2015**

- (54) **BLACKJACK GAME**
- (71) Applicant: **Yung Ju Choi**, Las Vegas, NV (US)
- (72) Inventor: **Yung Ju Choi**, Las Vegas, NV (US)
- (**) Term: **14 Years**
- (21) Appl. No.: **29/508,015**
- (22) Filed: **Nov. 1, 2014**
- (51) **LOC (10) Cl.** **21-03**
- (52) **U.S. Cl.**
USPC **D21/369**
- (58) **Field of Classification Search**
USPC D21/354, 369–375, 397; 273/142 E,
273/142 R, 143 R, 146, 268, 274, 292;
463/17; 434/128–129
CPC A63F 5/00; A63F 5/02; A63F 3/00157;
A63F 9/04
See application file for complete search history.

- D569,918 S * 5/2008 Kniffen D21/369
- 7,387,300 B2 * 6/2008 Snow 273/292
- D578,575 S * 10/2008 Clark et al. D21/369

* cited by examiner

Primary Examiner — Sandra Morris
(74) *Attorney, Agent, or Firm* — Lightbulb IP, LLC

(57) **CLAIM**
The ornamental design for blackjack game, as shown and described.

DESCRIPTION

FIG. 1 is a top plan view of a first embodiment of a blackjack game.
 FIG. 2 is a top plan view of a second embodiment of a blackjack game.
 FIG. 3 is a top plan view of a third embodiment of a blackjack game.
 FIG. 4 a top plan view of a fourth embodiment of a blackjack game.
 FIG. 5 is a close-up perspective view of region 5 of FIG. 1.
 FIG. 6 is a close-up perspective view of region 6 of FIG. 1.
 FIG. 7 is a close-up perspective view of region 7 of FIG. 2.
 FIG. 8 is a close-up perspective view of region 8 of FIG. 3.
 FIG. 9 is a close-up perspective view of region 9 of FIG. 3; and,
 FIG. 10 is a close-up perspective view of region 10 of FIG. 4.
 The portions shown in broken lines in the drawings illustrate an environment and are not part of the claimed design.

(56) **References Cited**
U.S. PATENT DOCUMENTS

- 5,275,416 A * 1/1994 Schorr et al. 273/292
- D402,331 S * 12/1998 Serowik et al. D21/369
- 5,863,041 A * 1/1999 Boylan et al. 273/292
- 6,491,302 B1 * 12/2002 Boylan et al. 273/292
- 6,679,492 B2 * 1/2004 Markowiak 273/274
- 6,811,153 B1 * 11/2004 Ko 273/292
- 6,854,733 B2 * 2/2005 Webb 273/292
- 6,902,167 B2 * 6/2005 Webb 273/292
- 7,264,243 B2 * 9/2007 Yoseloff et al. 273/292

1 Claim, 7 Drawing Sheets

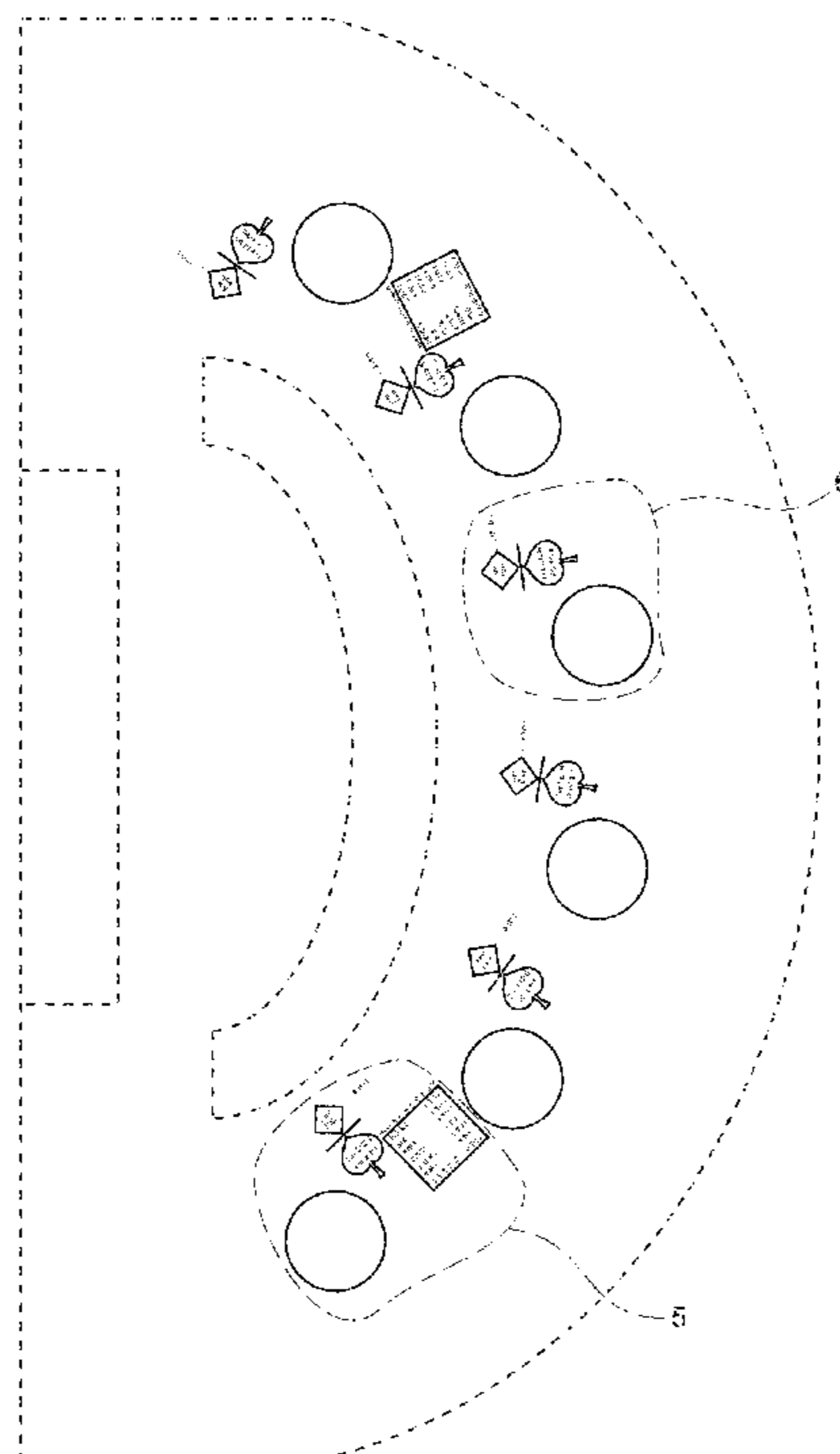

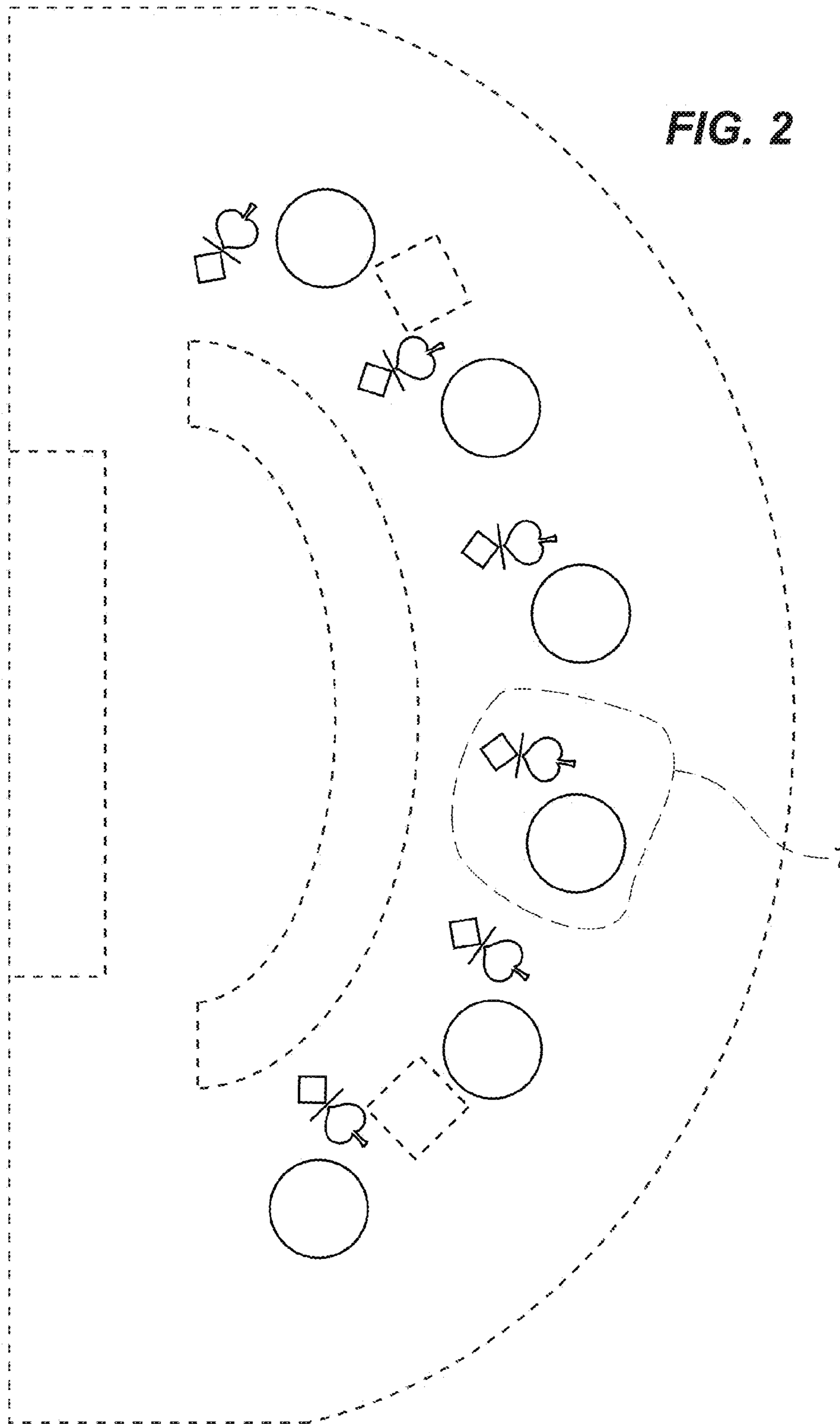

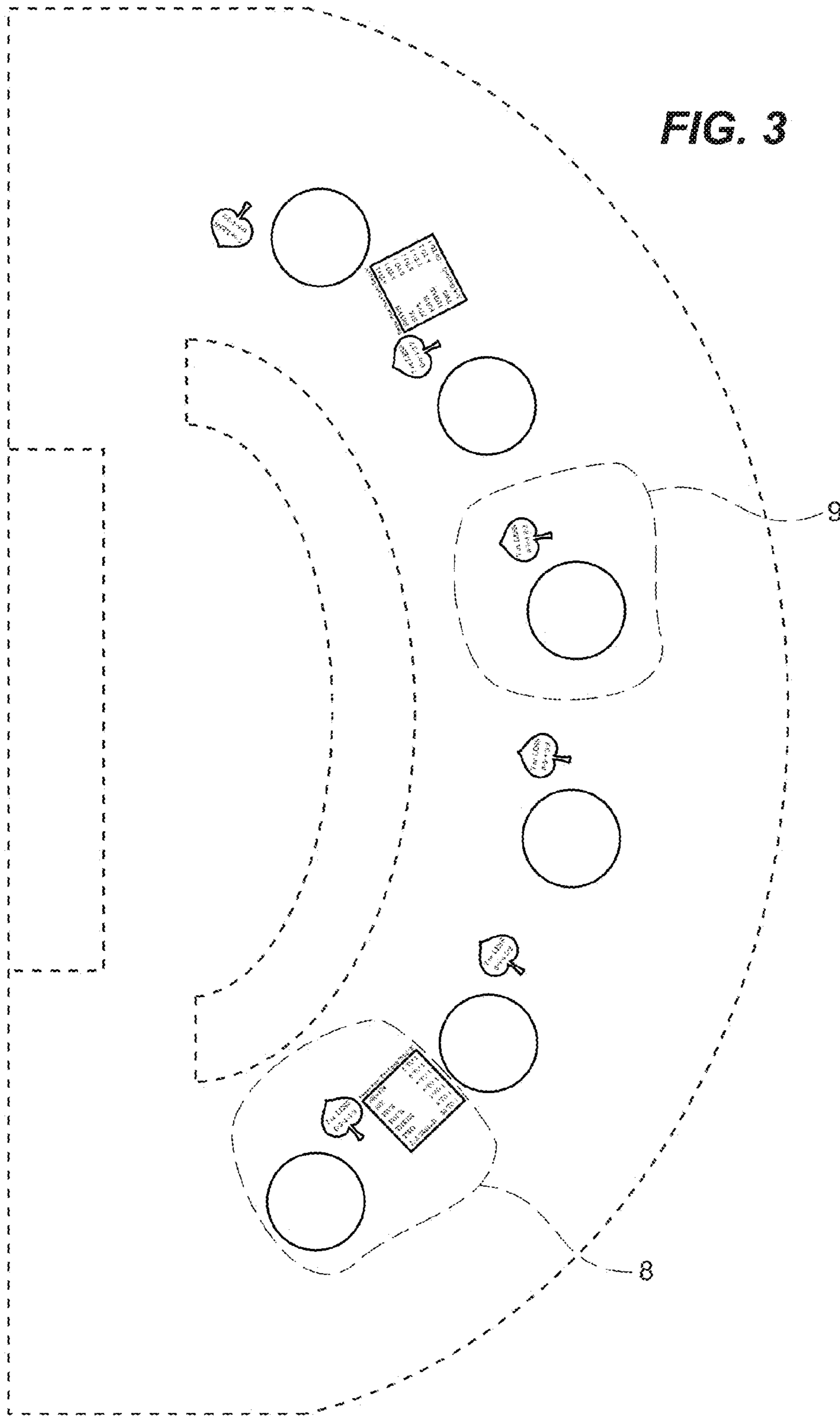

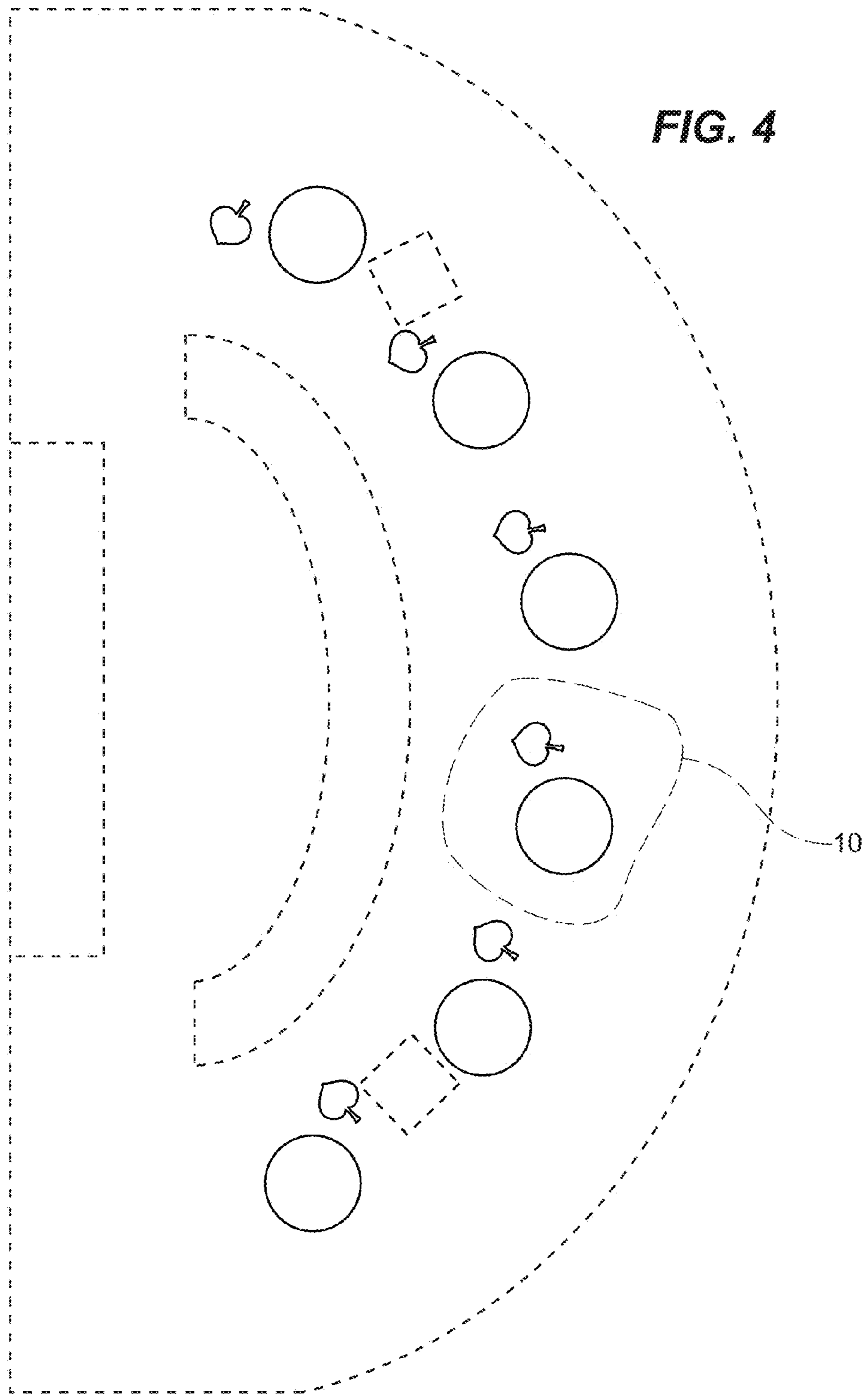

FIG. 5

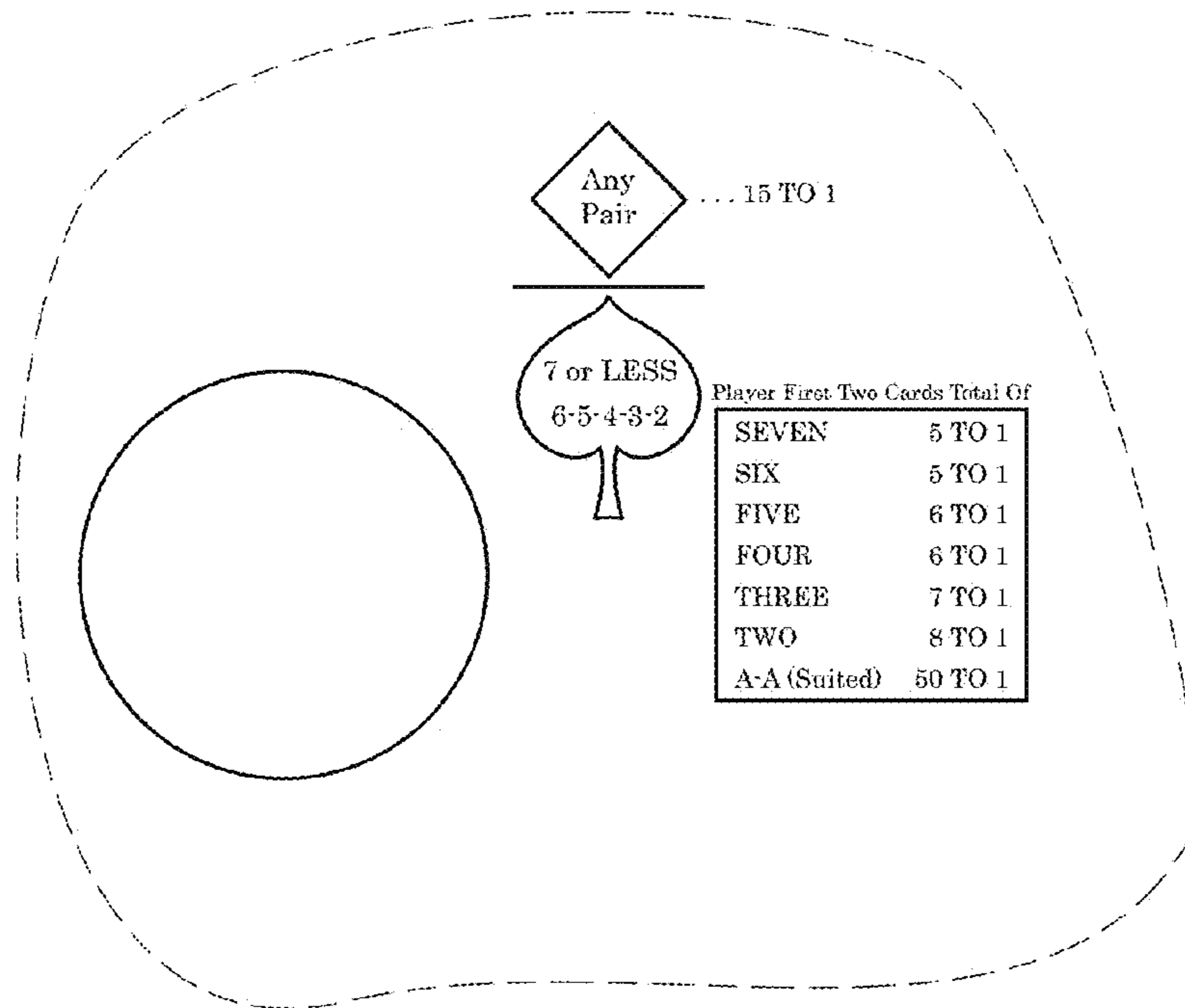

FIG. 6

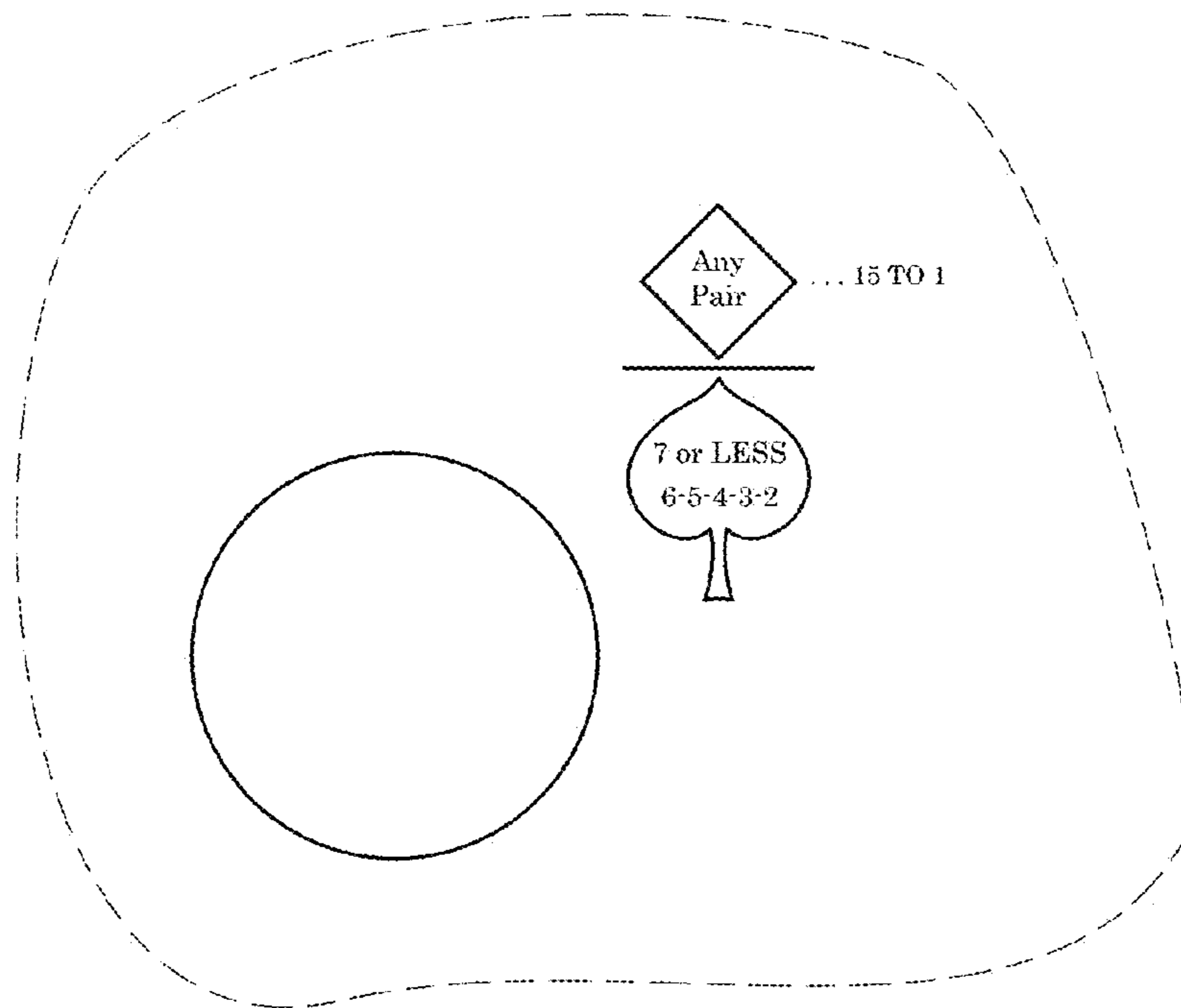

FIG. 7

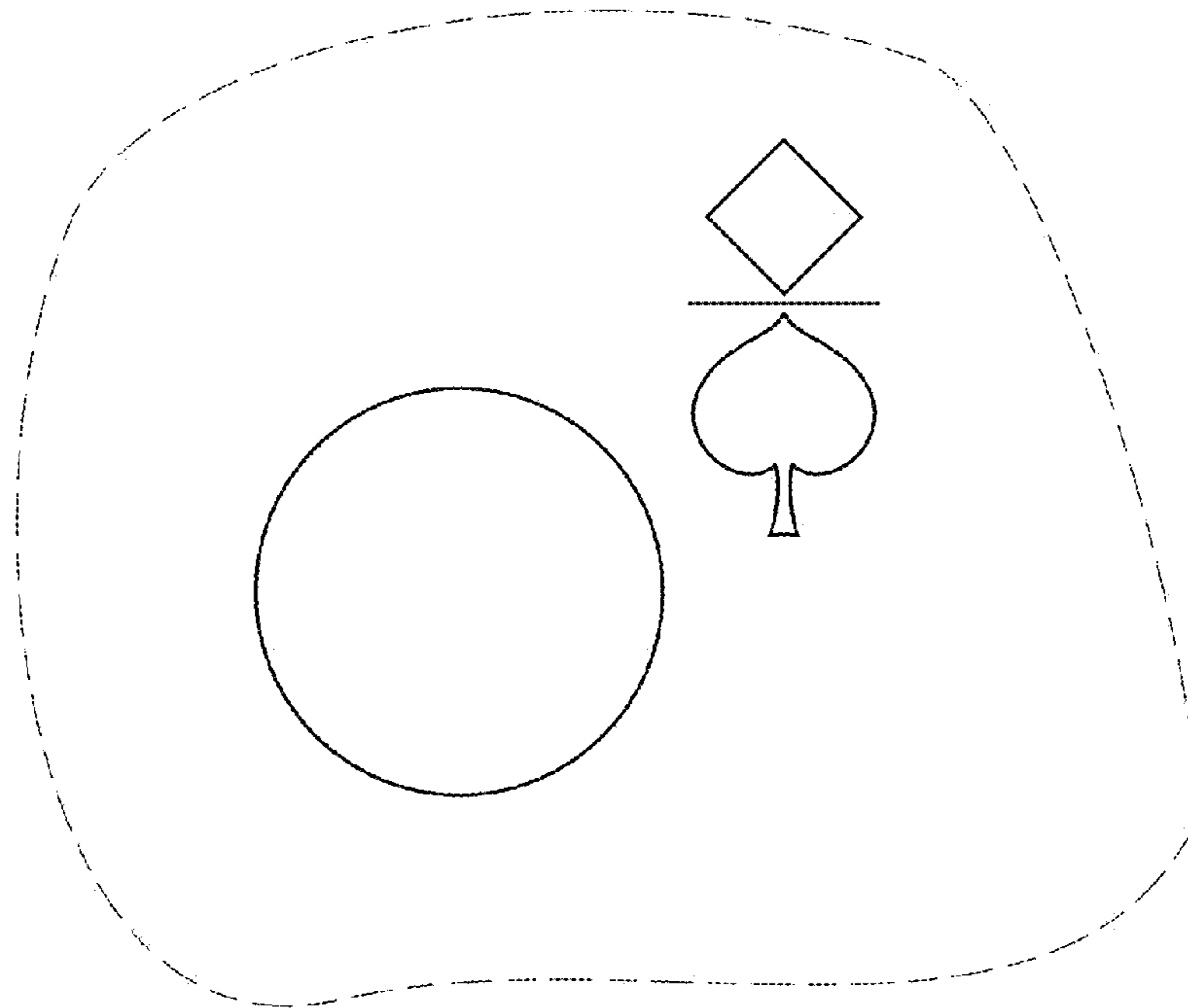

FIG. 8

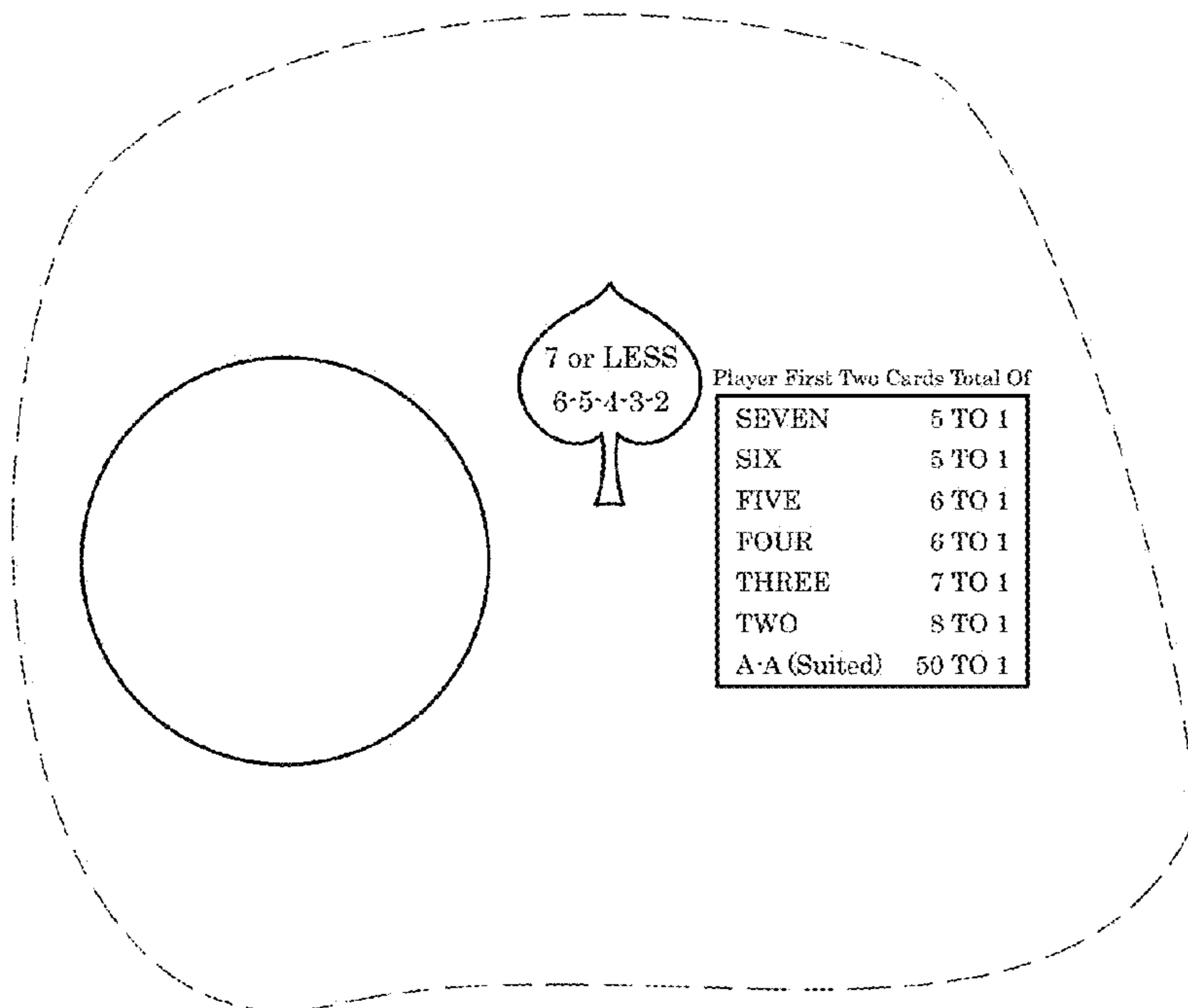

FIG. 9

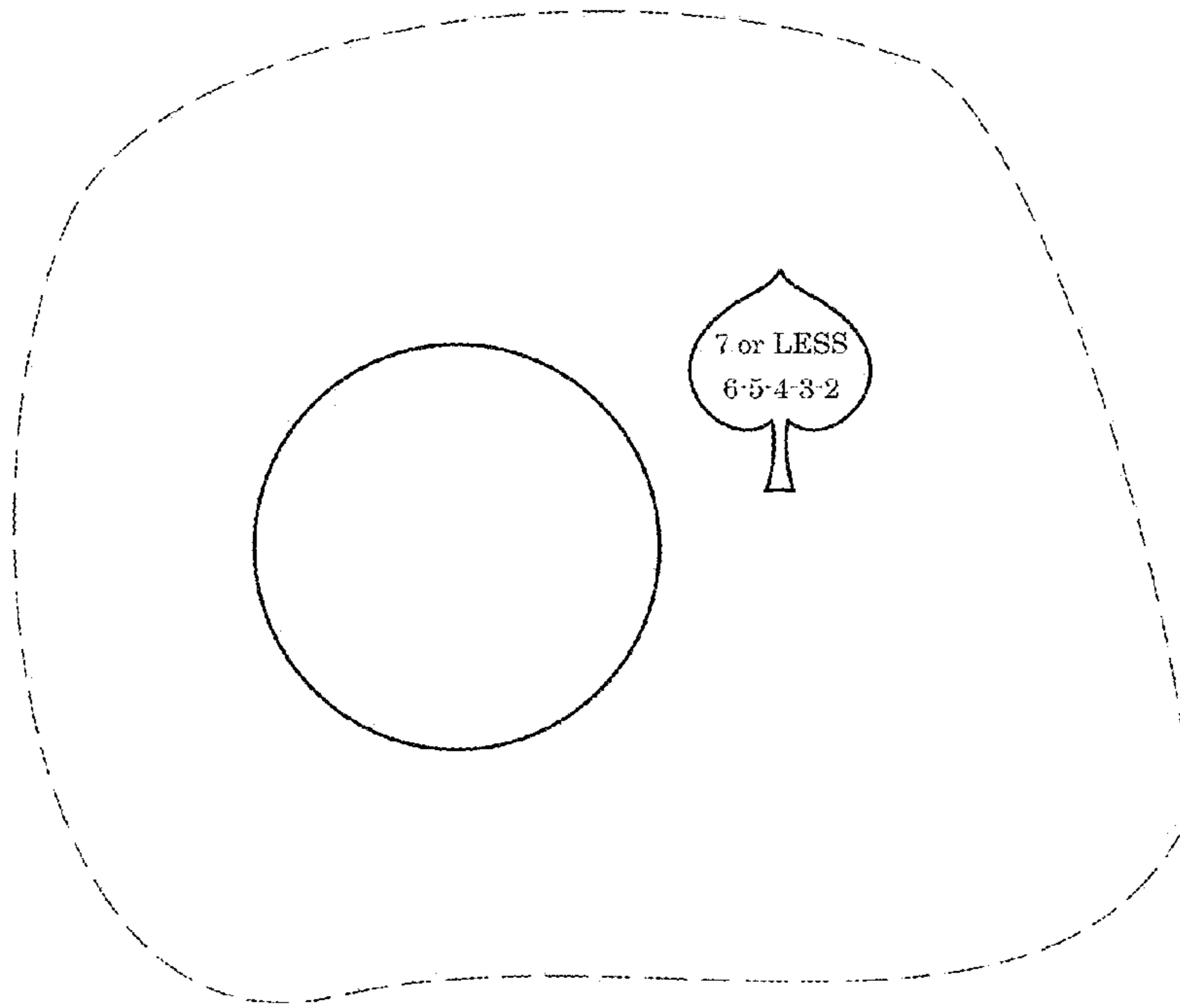

FIG. 10

