



US00D737897S

(12) **United States Design Patent**  
**Longo**

(10) **Patent No.:** **US D737,897 S**  
(45) **Date of Patent:** **\*\* Sep. 1, 2015**

(54) **PRINTING UNIT**

(71) Applicant: **Antonio Longo**, Prilly (CH)

(72) Inventor: **Antonio Longo**, Prilly (CH)

(73) Assignee: **BOBST MEX SA** (CH)

(\*\*) Term: **14 Years**

(21) Appl. No.: **29/470,037**

(22) Filed: **Oct. 17, 2013**

(30) **Foreign Application Priority Data**

Apr. 17, 2013 (CH) ..... 140001

(51) **LOC (10) Cl.** ..... **18-02**

(52) **U.S. Cl.**  
USPC ..... **D18/53**

(58) **Field of Classification Search**  
USPC ..... D18/53, 56, 59, 36, 38, 39, 40, 41, 45;  
D14/301, 307; 399/16, 75, 81, 131,  
399/151, 361, 365, 367, 381-385, 388  
CPC ... G06K 15/12; G06K 15/14; H04N 1/00204;  
H04N 1/00249; H04N 1/00278  
See application file for complete search history.

(56) **References Cited**

**U.S. PATENT DOCUMENTS**

4,752,803 A \* 6/1988 Sakurai et al. .... 399/1  
D298,254 S \* 10/1988 Morozumi ..... D16/223

D302,986 S \* 8/1989 Takai et al. .... D18/36  
D405,108 S \* 2/1999 Karafuji et al. .... D18/53  
D416,283 S \* 11/1999 Yamashita et al. .... D18/53  
D611,530 S \* 3/2010 Bundschuh et al. .... D18/53

**FOREIGN PATENT DOCUMENTS**

JP D1503396 \* 6/2014  
WO D081996-001 \* 10/2013  
WO D081996-002 \* 10/2013

\* cited by examiner

*Primary Examiner* — Bridget L Eland

(74) *Attorney, Agent, or Firm* — Ostrolenk Faber LLP

(57) **CLAIM**

The ornamental design for a printing unit, as shown and described.

**DESCRIPTION**

FIG. 1 is a front, right side, perspective view of a printing unit showing my new design;  
FIG. 2 is a front view thereof;  
FIG. 3 is a top view thereof;  
FIG. 4 is a right side view thereof; and,  
FIG. 5 is a left side view thereof.  
Portions of the printing unit not shown in the drawing form no part of the claimed design. The broken line showing of FIGS. 1-5 are for the purpose of illustrating environmental structure of the printing unit and form no part of the claimed design.

**1 Claim, 3 Drawing Sheets**

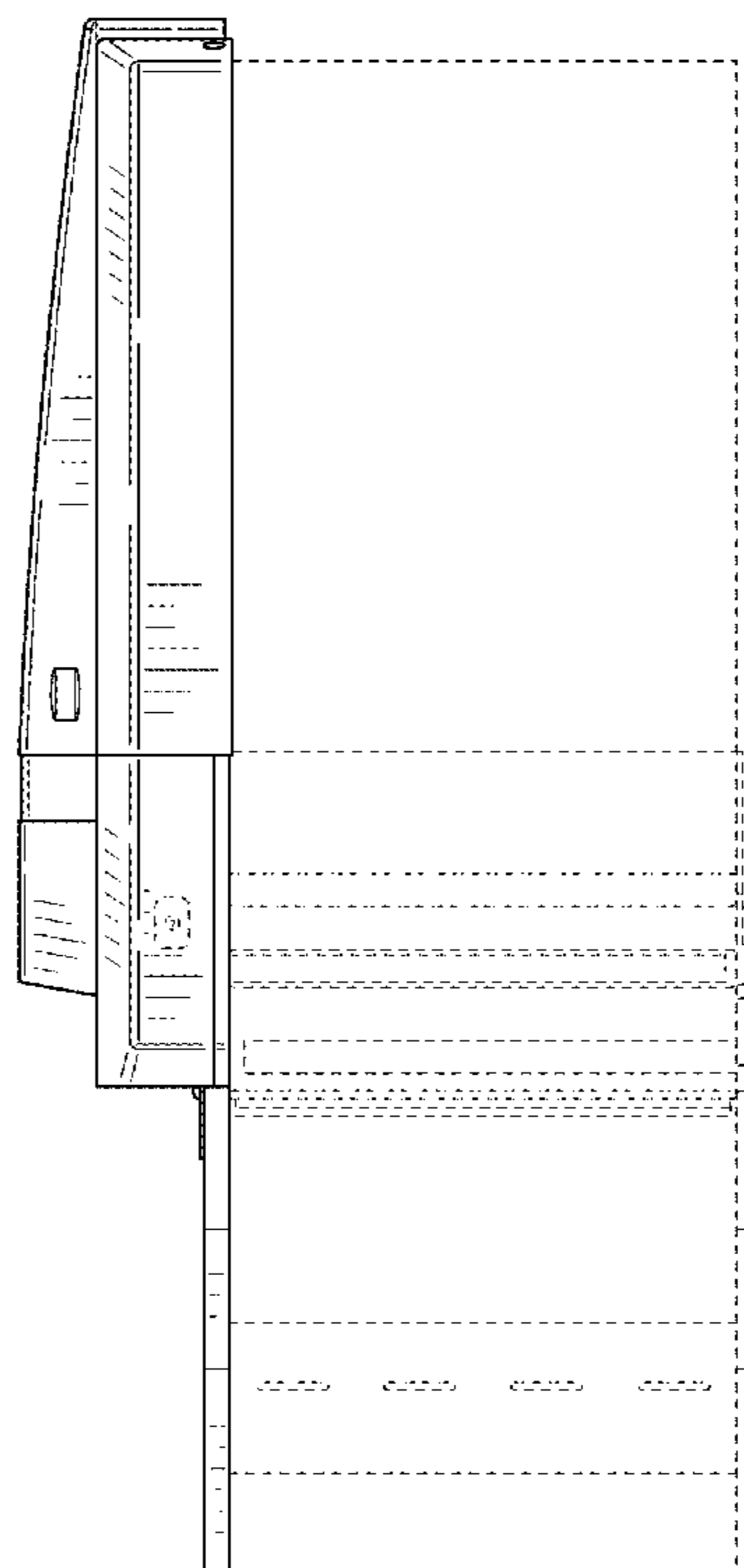
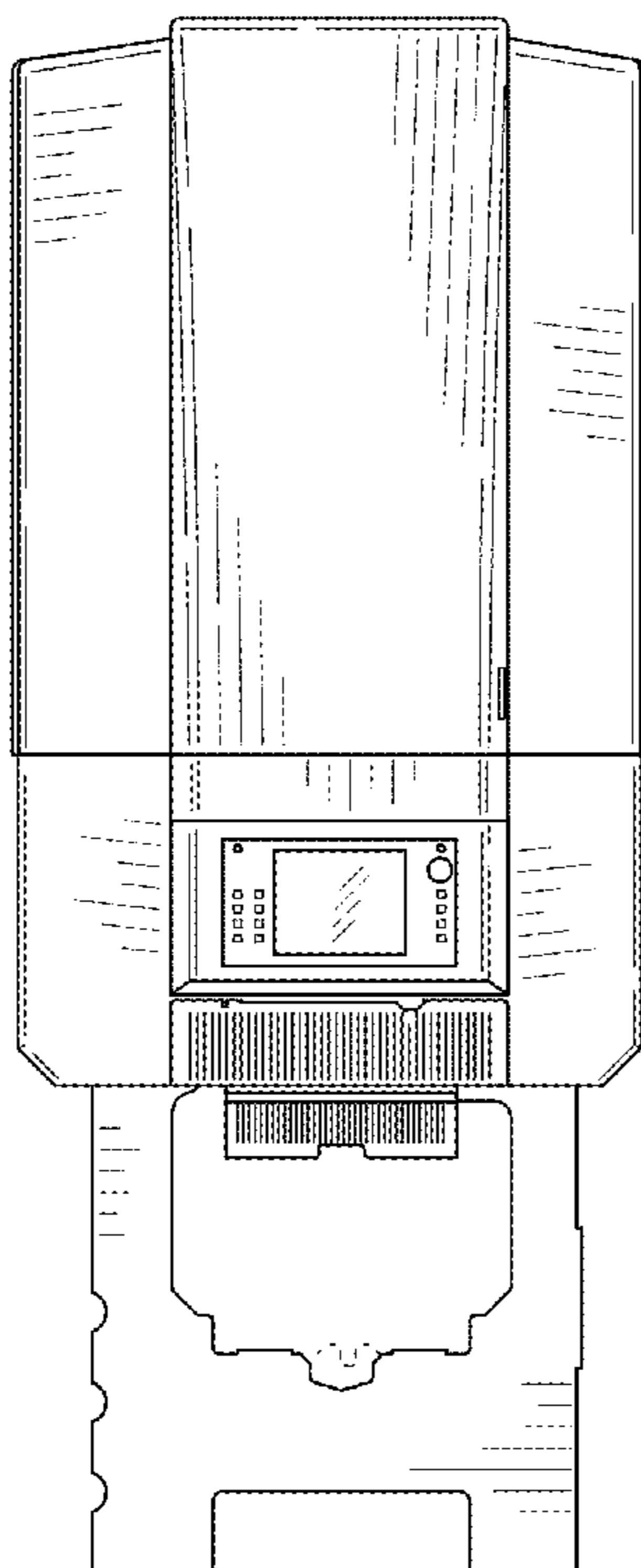

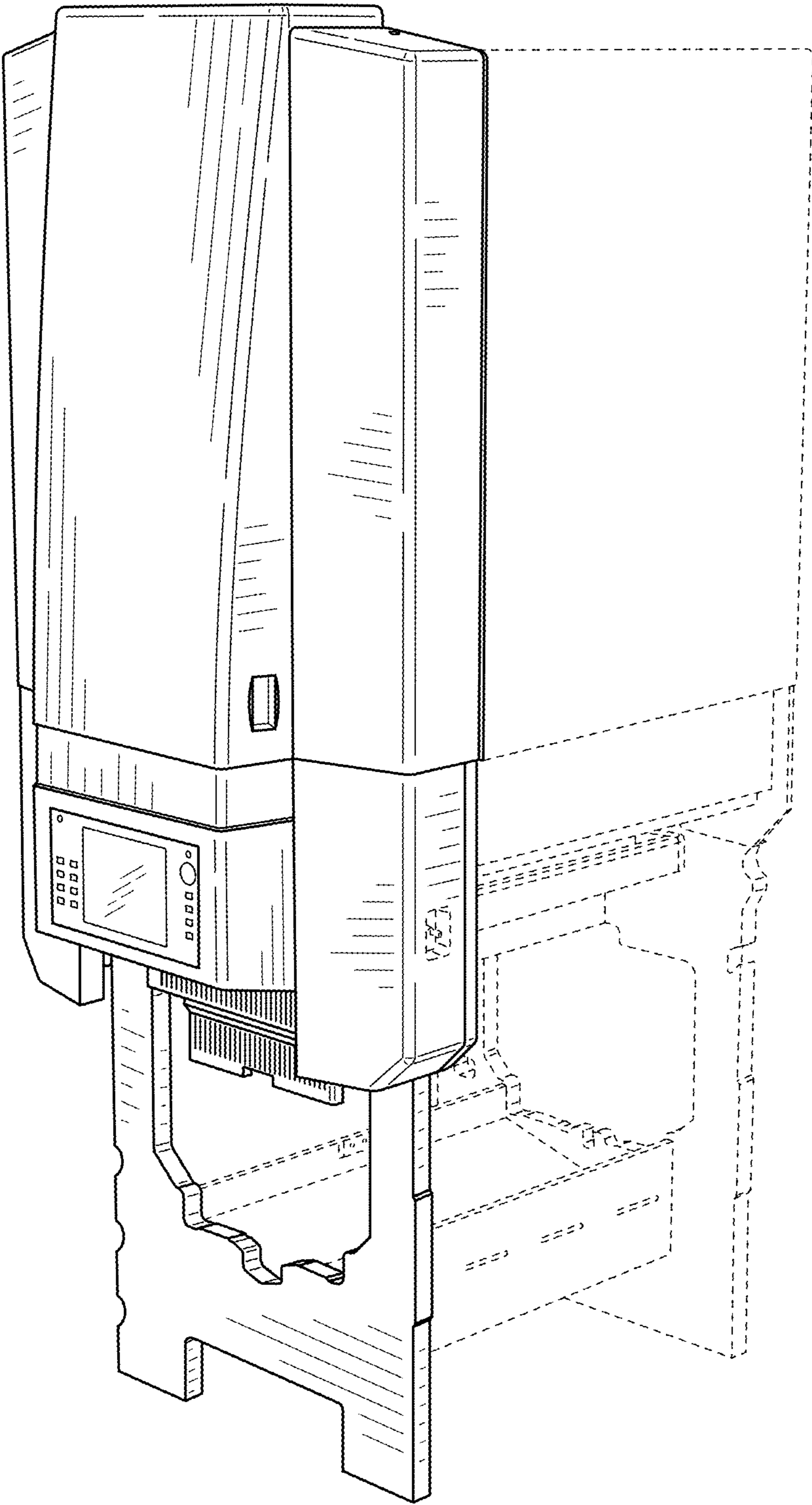

FIG. 1

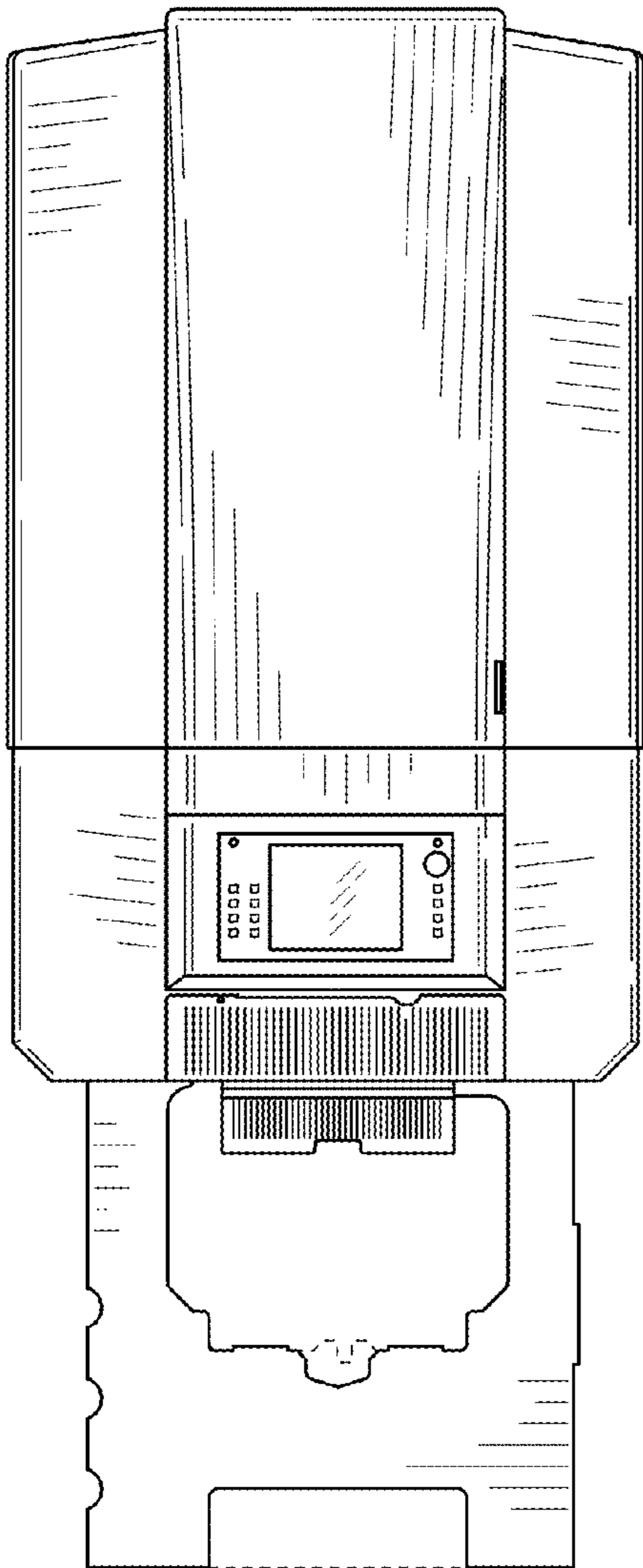

FIG. 2

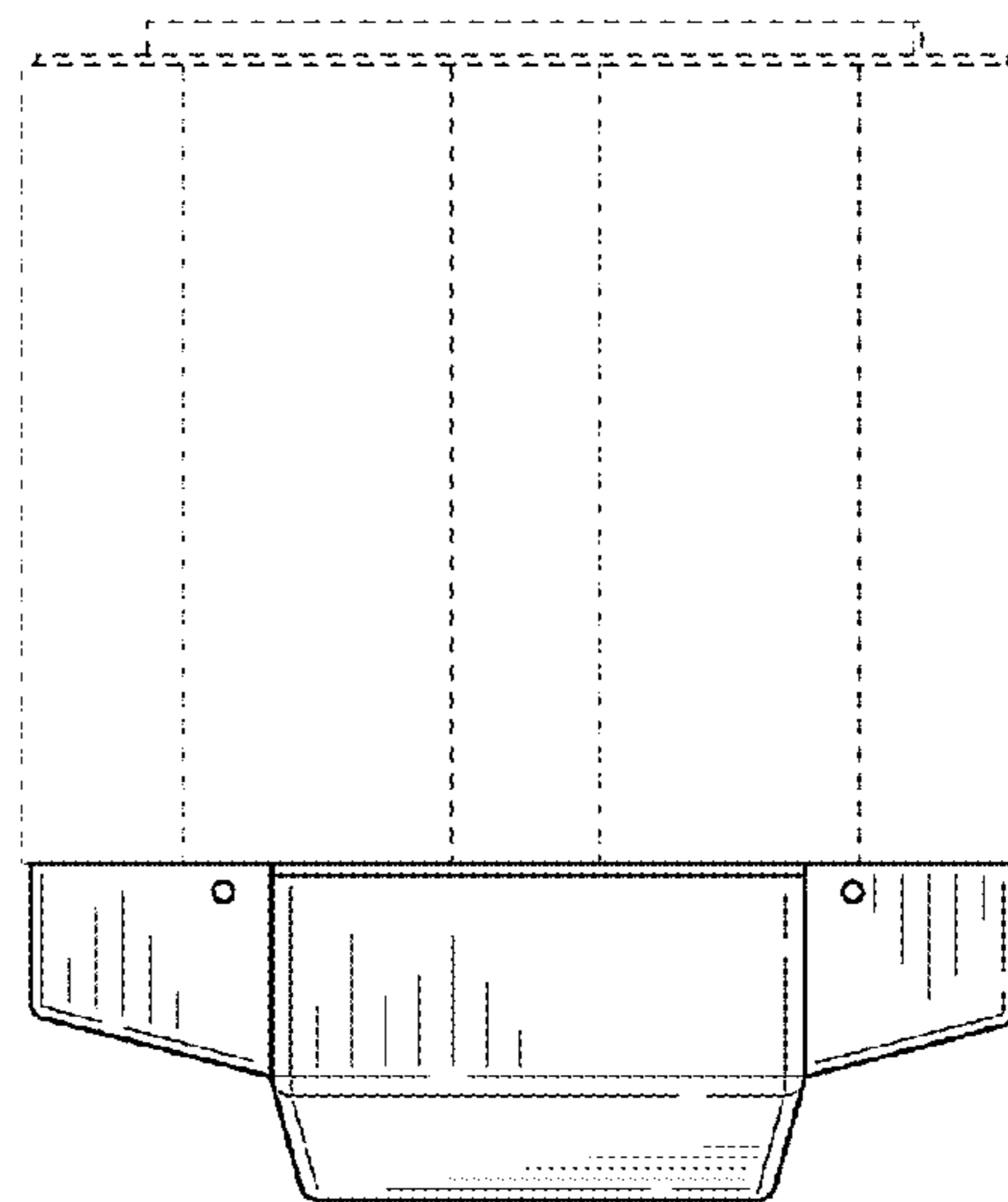

FIG. 3

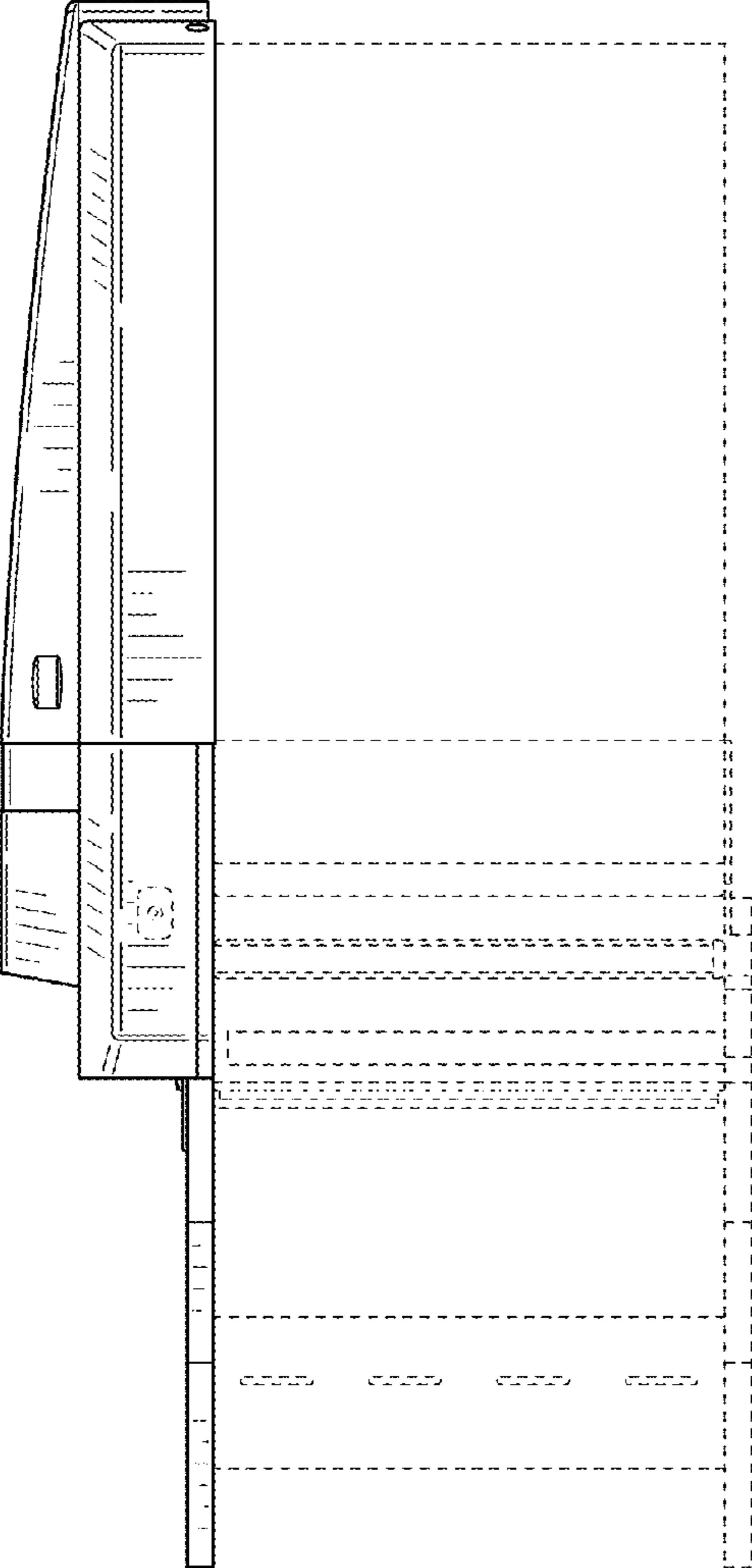

FIG. 4

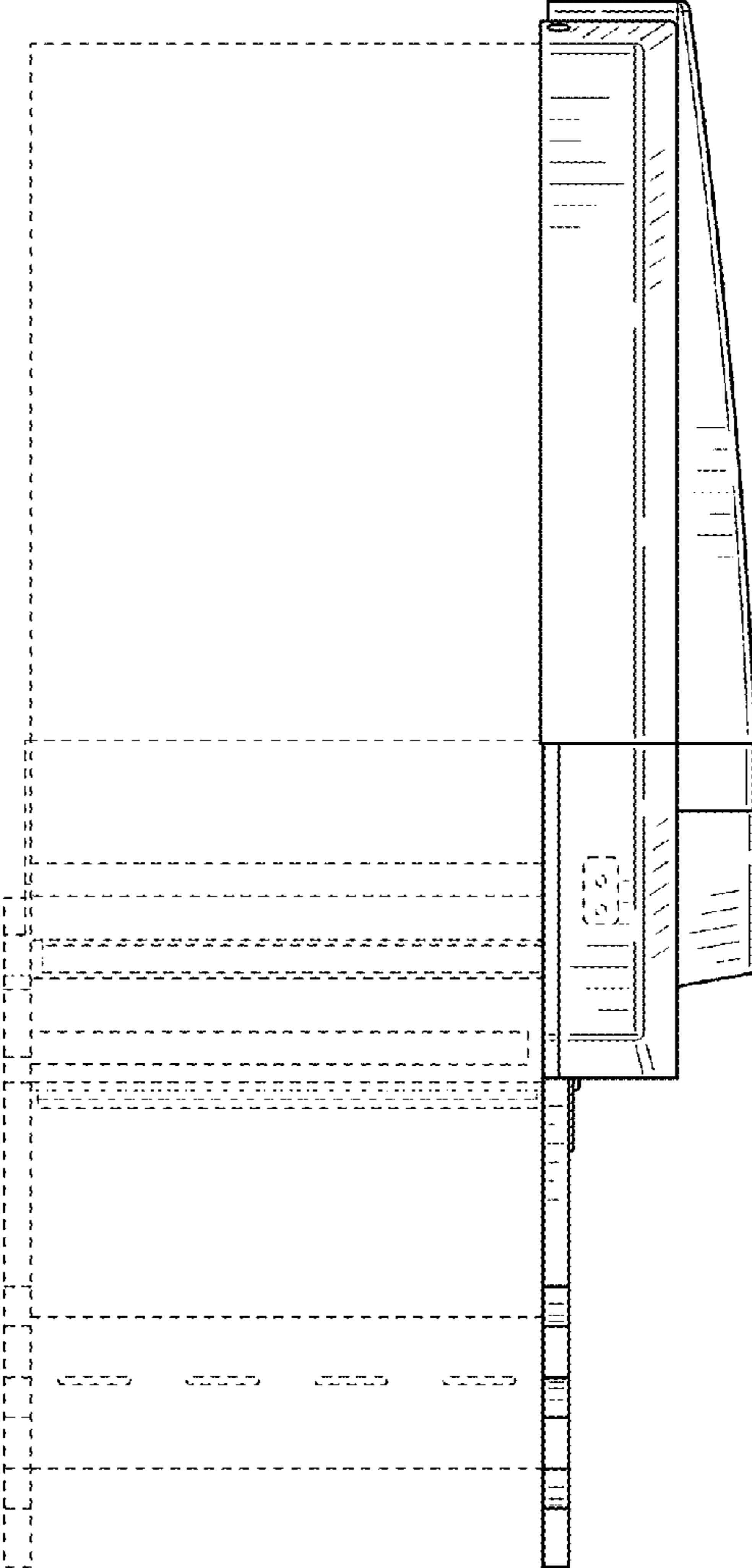

FIG. 5